

Product planning for the IEEE show 112

\$1.00 A McGraw-Hill Publication

Time sharing cuts display circuitry 120

March 2, 1970

Where are semiconductor memories heading? 143

Electronics®

**For RCA,
an era ends
and one
begins**





THE "INTERMEDIATE" SYNTHESIZER

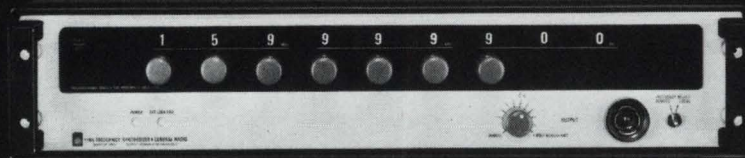

160 MHz for \$5900

Buying a frequency synthesizer has been something like buying a car. There's a confusion of models, options, and price ranges. Except — there has never been a so-called "intermediate"-model synthesizer. That's because price and performance ranges of synthesizers have tended to cluster just at both ends of the spectrum. The choice was between lower-cost, limited-frequency-range models and those with everything, including a sky-high price tag. So, the buying decision was one based on either trade-off or over-capability.

This is not true any longer! GR has filled the price-capability gap with the new 1165 Frequency Synthesizer. Frequency range is wide, 0.01 to 160 MHz in 100-Hz steps. The price is only \$5900, less than half the price it used to cost to get 160 MHz. If you can furnish your own frequency reference signal (5 or 10 MHz), you can get a model for only \$5300. In the \$5900 model, frequency accuracy is maintained either by an internal precision 10-MHz oscillator (1×10^{-9} per day) or by an external drive or lock source. Output is 0.1 to 1 V into 50 ohms. Both frequency and level can be externally programmed; the 1165 is ideal for applications requiring remotely-programmed local oscillators. Harmonics are typically down 30 dB (at maximum output into 50- Ω load); spurious, discrete non-harmonic signals are typically down 60 dB.

For complete information, write General Radio, West Concord, Mass. 01781; telephone (617) 369-4400. In Europe: Postfach 124, CH 8034, Zurich, Switzerland.

GENERAL RADIO



See the 1165 in action at the IEEE show, along with a "showroom" full of other products from GR. Booths 2E26-2E36.



ZAP!

HP's new 1100 V, 110 kHz calibrator keeps it from happening.

Let's face it, anybody that works with over 1000 volts learns to keep one hand in his pocket.

But, while it will always be primarily your responsibility when working with high voltage to protect yourself – it isn't your responsibility alone.

When Hewlett-Packard engineers developed the HP 746A High Voltage Amplifier for the HP 745A calibrator they had three definite goals in mind:

1. Give you the capability to calibrate to 1100 volts at 110 kHz.
2. Do it for a reasonable price.
3. Make it the safest piece of high voltage equipment available.

How well did they succeed? Well, the 745/746 calibration system provides outputs from as low as 0.100000 mV in 1 nV steps to as high as 1099.999 V in 1 mV steps. You get 7 voltage ranges, all with 6-digit adjustability. Frequency is from 10 Hz to 110 kHz in four overlapping decade ranges. You get direct error measuring capability plus the accuracy and stability you expect from an HP working standard.

Price? \$6500 for the whole system. Or, if you already have an HP 745A add the 746A for just \$2000.

Safety? It starts by lighting the red lightning bolt (international symbol for high voltage) whenever the 1100 V output is present. An overload causes the output to be automatically removed. Two sequential steps are required to obtain the high voltage output. These and many more safety features make the HP 746 the safest piece of high voltage equipment available today!

But the best way to convince yourself is to get the complete information on this complete calibration system. For more information, call your local HP field

engineer. Or, write to Hewlett-Packard, Palo Alto, California 94304. Europe: 1217 Meyrin-Geneva, Switzerland.

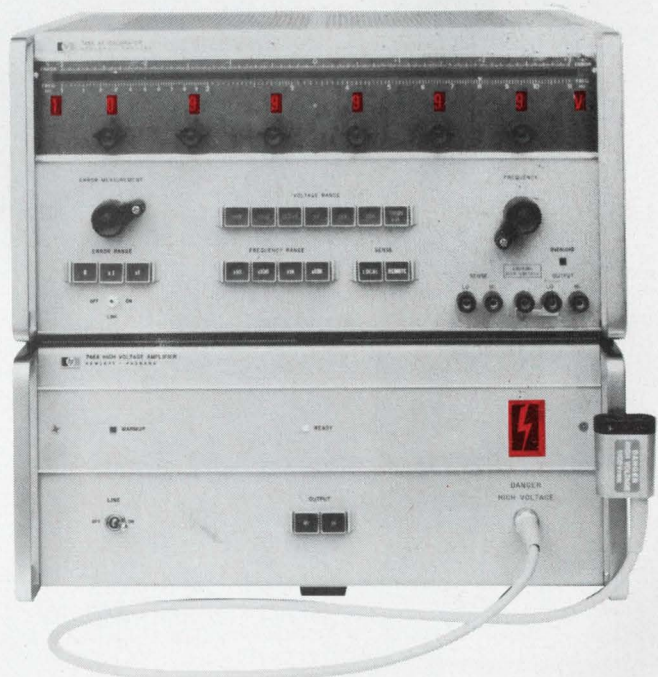

099/24

HEWLETT  PACKARD

WORKING STANDARDS

HP's time machine: it delivers 12 straight hours of recording at a 200-to-1 signal-to-noise ratio.

At 15/16 ips Hewlett-Packard's 3960 portable instrumentation recorder gives you a signal-to-noise ratio of 200 to 1 in FM. On that kind of performance you can record for over 12 straight hours without running out of tape—or running into noise.

A phaselock servo drive and modified zero loop tape drive assure our outstanding signal-to-noise ratio.

Add a rugged single casting capstan assembly, permanently adjusted brakes and built-in FM calibration facilities and you're talking about the most

machine per dollar you can buy today.

For just \$4285, you get a complete four channel quarter inch system with three electrically switchable speeds and FM response to 5 kHz. Models recording in direct to 60 kHz start as low as \$3970.

Options include dc/ac inverter for field recording and a loop adaptor which also adds to the long-playing capability. Set the loop size from 5 to 30 feet and use it to capture random or aperiodic events when they happen, whether you're monitoring the situation or not.

We'd like to demonstrate to you that

HP's 3960 is the best instrumentation recorder value on the market — for vibration and stress analysis, acoustical testing, oceanographic applications — in fact any environmentally tough research situation. Your local HP field engineer will be glad to set one up for a demo. Or write Hewlett-Packard, Palo Alto, California, 94304; Europe: 1217 Meyrin-Geneva, Switzerland.

HEWLETT  **PACKARD**

MAGNETIC RECORDERS

Circle 2 on reader service card

42002



Features

Probing the News

- 143 **Solid State:** Semiconductor memories—what's here now, what's on the way
148 **Communications:** Vehicle locator systems seek out markets

U.S. Reports

- 39 **Space electronics:** SMS, a geostationary weather satellite
40 **Communications:** Competition for Omega receiver contract
41 **Communications:** Can Mallard arise from its own ashes?
42 **Manufacturing:** Laser scribe interest quickens
44 **Commercial electronics:** Mylar-coated keyboard
48 **Contracts:** Hearings to focus on small-business plight
52 **For the record**

Electronics International

- 65 **France:** Teaching machines star at audio-visual show
66 **Great Britain:** Lead-tin telluride i-r detector
67 **Great Britain:** Ignition GaAs
68 **West Germany:** Pulsed i-r communications link

New Products

- 159 **In the spotlight**
159 Computer clocks at 10 megahertz
164 **IEEE Show product preview**
164 Sweeper reaches 2.35 Ghz
164 2 entries in low-priced dvm field
166 Sampling-scope rate is adjustable
168 Angle-indicator is fast, accurate
172 Module simplifies logic design
176 **Components review**
176 On-card regulator dissipates 5 w
181 **Data handling review**
181 Memory has 800-nsec access time
185 **Production equipment review**
185 All-digital-input deposition unit
189 **Semiconductor review**
189 Transconductance amp is versatile
192 **New materials**

Articles

Special report 88

A new boss cuts a new groove at RCA
An era ended when the reins passed from father to son; now Robert Sarnoff plans initiatives in computers and communications
Roger Kenneth Field,
Electronics staff

Circuit design 104

Design's casebook
▪ Capacitors add up in voltage multiplier
▪ A staircase and a ramp yield multiple sawtooths
▪ Variable d-c input adjusts pulse width over wide range

Memories 108

Backward step opens up new route to new products and new markets
Product planning offers lessons to the industry; by modifying core size to slow a memory and cut costs, mass production and sales appeal were achieved
Jack Buckwalter,
Ferroxcube Corp.

Product planning 112

In-depth product planning bears fruit in electronics bowing at IEEE Show
Technical capability doesn't guarantee profit; knowing who, what, and when to sell counts

Displays 120

Dot matrix display features inherent scanning ability
Propagating glow discharge from cell to cell reduces addressing and drive circuitry
William J. Harmon Jr.,
Burroughs Electronic Components

126

Strobing makes longer LED alphanumeric displays possible
Time sharing reduces the amount of addressing and decoding circuitry needed for light-emitting diode arrays
Howard Borden and Richard Kniss,
Hewlett-Packard Associates

132

Segmented array simplifies external address circuitry
Solid state display operates at low voltage and power; capabilities and readability are useful for counting
R.T. Gill,
Monsanto Co.

Departments

- | | |
|-----------------------------|-----------------------------|
| 4 Editorial Comment | 41 Index of Activity |
| 5 Readers Comment | 63 International Newsletter |
| 9 Who's Who in this issue | 77 Washington Newsletter |
| 14 Who's Who in electronics | 193 New Books |
| 22 Meetings | 194 Technical Abstracts |
| 33 Electronics Newsletter | 197 New Literature |

Electronics

Editor-in-Chief: Donald Christiansen

Senior staff editors

Technical: Stephen E. Scrupski

News: Robert Henkel

International: Arthur Erikson

Art director: Gerald Ferguson

Assistant managing editors: H. Thomas

Maguire, Howard Wolff, William Bucci,

Richard Gundlach, Frederick Corey

Special projects editor: Roger Kenneth Field

Senior staff writer: John Johnsrud

Reader communications manager: John

Drummond

Department editors

Senior associate editors: Joseph Mittleman, Harry R. Karp; Advanced technology: Laurence Altman; Communications: Leon M. Magill; Computers: Wallace B. Riley, George Weiss; Design theory: Joseph Mittleman; Industrial electronics: Harry R. Karp; Instrumentation: Owen Doyle; Military/Aerospace: Alfred Rosenblatt; New products: William P. O'Brien; Solid state: George Watson, Stephen Wm. Fields

Copy editors: Edward Flinn, William S. Weiss

Assistant art director: Charles Ciatto

Production editors: Susan Hurlburt, Arthur C. Miller; Editorial research: Virginia Mundt; Editorial secretaries: Claire Goodlin, Bernice Pawlak, Barbara Razulis, Vickie Green, Terri O'Neill.

Field bureaus

Boston: James Brinton, manager; Gail Farrell; Los Angeles: Lawrence Curran, manager; Ralph Selph; New York: Peter Schuyten; San Francisco: Stephen Wm. Fields, Marilyn Howey; Washington: Ray Connolly, manager; Robert Westgate, Lois Vermillion; Frankfurt: John Gosch; London: Michael Payne; Paris: Arthur Erikson; Tokyo: Charles Cohen

Reprints: Virginia Mundt; Circulation: Isaaca Siegel

Publisher: Gordon Jones

Associate publisher: Dan McMillan

Assistant to the publisher: Wallace C. Carmichael

March 2, 1970

Good new products: good fortune or good planning?

● Once upon a time, the technologist's role in product planning was largely passive. His labors too often were guided by his interest in phenomena that held a fascination for him. Or, his labors were constrained and directed by edict from above. In the latter case, the natural instinct that leads good engineers to create products that do something useful was thwarted, or not cultivated.

Today, however, the picture is changing. More and more, the engineer is finding himself part of a product-planning team. Now he's required to cast his vote to help reach decisions that affect the products his company will be making five or 10 years from now. Thus, despite the quite proper propensity of the engineer to concern himself largely with technological matters, he now must consider other factors, too—factors inherent to the product-planning process. For example, he must examine product needs, evaluate his company's qualifications, consider new investment required, and assess the risks of obsolescence for both the proposed new product and the production equipment needed.

Furthermore, he must try to anticipate how the competition will react, and often will need to consider general business conditions, long-range national goals, and even political factors. Some of the considerations will, at times, be overriding, as in the case of the effects of national goals and commitments on certain military electronics projects.

Corporate strategy can be another overriding factor. A company may elect to be the best second source of a particular product, while another may aim for the leader's role. Or a military equipment producer may choose to be responsive to rfp's, rather than operate in the synthesis mode

where it concentrates on unsolicited proposals, working closely with the customer to jointly define needs.

A sometimes hidden factor in product planning relates to the enchantment of both customer and supplier with the psychological aspects of new products. The "fashionable factor" influences, perhaps unduly, highly technical product plans. For example, digital techniques enjoy an "in" status. And customers often expect computers to be built into newer systems (needed or not, they are often justified on the basis of "versatility"). Some of the window-dressing injected into new electronic products add little or nothing to the cost of the product—it's comparable to 150-mph speedometers on family cars. But in other cases, catering to the whims of customers is expensive (it is sometimes simpler and cheaper to use a straightforward analog technique instead of using currently popular digital methods). So product planners must contend with the demands of potential customers and weigh them against the realities of cost and performance.

A product's lifetime and development cycle time become more critical planning elements as they get shorter—the current trend in the electronics business. Engineers must judge what percentage of the product lifetime they can allot to the development time. And they must consider how a successful product is phased out when a better one is introduced.

In any event, the day when the engineer could say to the marketers, "I have a thing that does such and such . . . can you sell it?" is rapidly passing (though one suspects that an occasional product will be brought to market via this route for years to come). Finding homes for innovative products is giving way to a process that, as one product

Published every other Monday by McGraw-Hill, Inc. Founder: James H. McGraw 1860-1948. Publication office 99 North Broadway, Albany, N. Y. 12202; second class postage paid at Albany, N. Y. and additional mailing offices.

Executive, editorial, circulation and advertising addresses: Electronics, McGraw-Hill Building, 330 W. 42nd Street, New York, N. Y. 10036. Telephone (212) 971-3333. Teletype TWX N. Y. 710-581-4235. Cable address: MCGRAWHILLN.Y.

Subscriptions solicited only from those professionally engaged in electronics technology. Subscription rates: qualified subscribers in the United States and possessions and Canada, \$8.00 one year, \$12.00 two years, \$16.00 three years; all other countries \$25.00 one year. Non-qualified subscribers in the U.S. and possessions and Canada, \$25.00 one year; all other countries \$50.00. Air freight service to Japan \$50.00 one year. Single copies: United States and possessions and Canada, \$1.00; all other countries, \$1.75. Officers of McGraw-Hill Publications Company: Joseph H. Allen, President; John R. Emery, J. Elton Tuohig, Senior Vice Presidents; Gordon L. Jones Jr., Group Vice President; Vice Presidents: John R. Callahan, Editorial; John M. Holden, Marketing; David G. Jensen, Manufacturing; Jerome D. Luntz, Planning & Development; Robert F. Marshall, Administration; Robert M. Wilhelm, Finance; Director of Circulation: Ralph Blackburn.

Officers of the Corporation: Shelton Fisher, President and Chief Executive Officer; John J. Cooke, Senior Vice President and Secretary; Gordon W. McKinley, Vice President and Treasurer. Title © registered in U.S. Patent Office. © Copyright 1970 by McGraw-Hill, Inc. All rights reserved. The contents of this publication may not be reproduced either in whole or in part without the consent of copyright owner.

Subscribers: The publisher, upon written request to our New York office from any subscriber, agrees to refund that part of the subscription price applying to copies not yet mailed. Please send change of address notices or complaints to Fulfillment Manager; subscription orders to Circulation Manager, Electronics at address below. Change of address notices should provide old as well as new address, including postal zip code number. If possible, attach address label from recent issue. Allow one month for change to become effective.

Postmaster: Please send form 3579 to Fulfillment Manager, Electronics, P.O. Box 430, Hightstown, New Jersey 08520.

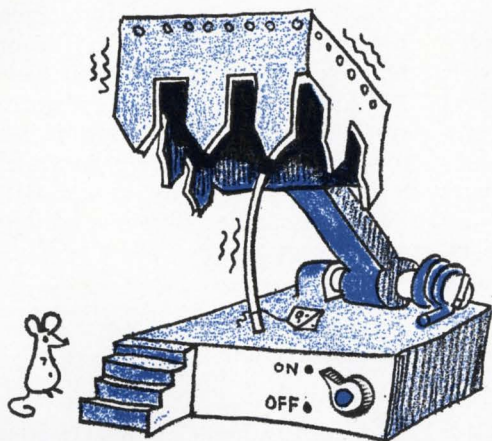

To the Editor:

Disappointment best described my feeling when I read your article about tape stiction [Jan. 19, p. 46], a problem that has been identified for well over eight years in the spacecraft recorder business. The characteristics of stiction were correctly described in the article, but, alas, no solution was offered. With a multimillion dollar space shot forthcoming, I thought it would be worthwhile to mention that a workable solution does exist. The solution our firm has consistently used involves four main considerations:

We use the newer hard-faced heads which typically employ hard-tipped ferrite cores. If an erase is required, it should also be hard faced or use sapphire rods to avoid a large contact area.

Furthermore, it was recognized that a recorder must have adequate motor torque margin to overcome not only minor tape head stiction (no oxide deposits on the heads) but also mechanical anomalies that might occur.

In addition, we use only preconditioned tape which has been properly cleaned of all debris due to slitting and initial sloughing.

A tape type which is in volume production is carefully selected and tested, and, then, a sufficient quantity from the same web is purchased to insure consistent batch conditions. The variations within the web have proven to be acceptable if all other conditions are met.

Our company has found that, without exception when all four recommendations are religiously followed, no data degradation or life-limiting form of stiction will occur, even at upper thermal soaks of 55°C. Mention should be made that the in-can atmosphere in all our experience has never been a determining factor. Typical in-can atmosphere would be obtainable by a multiple operation, vacuum purging of all air within the enclosure, and, then, an inert gas such as dry nitrogen would be introduced along with a small percentage of helium for leak detection.

The remaining moisture that is trapped within the oxide binder material will eventually work out to alter the original in-can atmosphere conditions. With proper control this variation in exact moisture content has not been found to alter appreciably the factors leading to tape stiction.

Jerry Muench

Odetics Inc.
Anaheim, Calif.

It's time to check . . .

To the Editor:

With regard to your survey of the Swiss
(continued on p. 6)

planner at Ampex describes it, determines first "whether beasts the size of our traps really exist." One Hewlett-Packard manager likens the product planning process to matching the pickets in a picket fence of ideas to the pickets in a fence of needs. A technologist at RCA points out (see p. 96) that SelectaVision came about "not because a guy was playing around with holograms, but rather because some guy was looking at new products that were needed—keeping in mind the pool of available technology—and he found a match."

Yet one must recognize that there are both obvious needs and latent needs; that is, in some cases a market does not and cannot exist until the product is developed.

Despite the growing trend to formalize product planning, there are many paths to successful products. For example, a case can be made for product development by fallout. The technique can involve genuine product planning, as opposed to accident or simple good fortune. Sometimes product planners even elect to take what appears to be a step backward in technology utilization in order to take two forward (see p. 108).

The options available to planners as well as the changing role of the technologist in product planning prompted *Electronics* to conduct a series of forums in seven major cities across the U.S. last month, in which product planners, planning executives, and technologists traded ideas. The editors of *Electronics*, who served alternatively as coordinators and devil's advocates during these forums, are preparing a report summarizing their findings; it will be published in a forthcoming issue.—D.C. ●

McGraw-Hill News Service

Director: Arthur L. Moore; Atlanta: Fran Ridgway; Chicago: Robert E. Lee; Cleveland: Arthur Zimmerman; Dallas: Marvin Reid; Detroit: James Wargo; Houston: Barbara LaRouax; Los Angeles: Michael Murphy; San Francisco: Margaret Drossel, Tyler Marshall; Seattle: Ray Bloomberg; Washington: Charles Gardner, James Canan, Herbert W. Cheshire, Seth Payne, Warren Burkett, William D. Hickman; Bonn: Robert F. Ingersoll; Brussels: James Smith; Hong Kong: Kate Mattock; London: John Shinn; Mexico City: Gerald Parkinson; Milan: Jack Star; Moscow: Jack Winkler; Paris: Robert E. Farrell, Stewart Toy; Tokyo: Marvin Petal



28V DTL POWER GATE

Problem: Find 28 volt 4-input DTL power gate immune to 80 volt transients.

Solution: The Siliconix H-100 Dual Power Gate, offers high AC and DC noise rejection and operates directly from 28 volt power supplies.

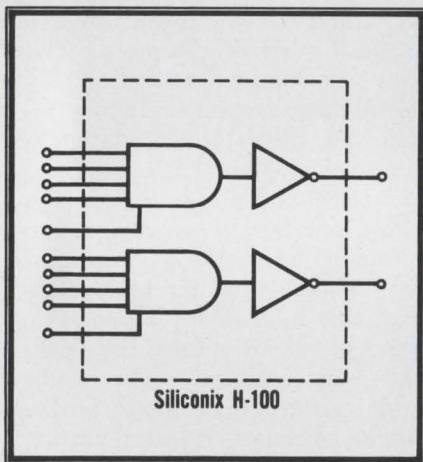

The H-100 was developed for use with noisy aircraft and marine power supplies; output drives 100 mA and sustains 90 volts. Available in TO-86 or TO-116 packages. Write or call today for the data sheet on the Siliconix H-100!

Siliconix
incorporated

2201 Laurelwood Rd. • Santa Clara, Calif. 95054
(408) 246-8000 Ext. 201 • TWX: 910-338-0227

Readers Comment

electronics market [Dec. 22, 1969, p. 100], I think it very unlikely that Ebauches Electronics will produce 30 million electronic movements per year with 1,200 workers even though it has invested heavily in its new production facilities. It should be noted that the Bulova Watch Co. has been producing tuning fork watches in Bulova's Swiss plants in Bienne and Neuchatel since 1963. These watches are made with European components. Ebauches SA will produce its own tuning fork watch under a license agreement with Bulova.

It is also our understanding that Omega has not taken over Compagnie pour l'Industrie Radio-electrique (CIR), but rather a division of the Electronic Watch Center (CEH), which has, in fact, developed a tuning fork watch similar to Bulova's Accutron.

Furthermore, I believe that Philips is the majority stockholder (55%) of Fabrication des Semiconducteurs SA (Faselec), and not a minority one as you state.

Hans Schaller

R&D director,
Bulova Watch Co.
Bienne, Switzerland

... on time pieces

To the Editor:

We were astonished to read in your review that our company (CIR) has been taken over by Louis Brandt et Frere SA (Omega). We should like to point out that since 1964, our company name has been Compagnie Industrielle Radioelectrique. Furthermore, while we have conducted business with the Omega group, that company has never been interested in our capital. It is also erroneous to say that we were set up by the Horological Electronics Center. While it is true that the center does rent laboratory space in our factories, it has no financial interest in CIR.

E. Muller

l'Administrateur-Delegue,
Compagnie Industrielle
Radioelectrique
Berne, Switzerland

▪ As both Messrs. Schaller and

Muller point out, CIR is not owned by the Omega group. The Omega group took over a department, now known as Elresor SA, which was formerly part of the Horological Electronics Center. And, Elresor, rents space in CIR's plant at Gals. As for Philips, it was majority stockholder in Fasec before it was reconstituted as Faselec, in which it is only a minority holder with Swiss companies together holding majority interest.

Bad connection

To the Editor:

In the Readers Comment section of the Jan. 5 issue of *Electronics*, Richard McBeth wrote to you asking where he could obtain a copy of the specifications which must be met to connect foreign objects to a telephone line. You referred him to FCC Tariff No. 263 of AT&T. I wrote to the address you listed and W.E. Albert of AT&T referred me elsewhere. Mr. Albert, in his reply, told me in essence that AT&T couldn't justify the expense of printing and distributing FCC tariffs to those of the company's 7,000 private-line customers who might request them.

Rather than provide me with the information, he suggested that should I wish to purchase any of AT&T's tariffs, I should contact Cooper-Trent Inc., 1130 19th St., N.W., Washington, D.C. 20036, which Mr. Albert believes holds an FCC contract to duplicate all FCC tariff material.

Edward J. Brauner

Chief engineer,
Branco Controls division
Ledex Inc.
Piqua, Ohio

SUBSCRIPTION SERVICE

Please include an *Electronics Magazine* address label to insure prompt service whenever you write us about your subscription.

Mail to: Fulfillment Manager
Electronics
P.O. Box 430
Hightstown, N.J. 08520

To subscribe, send us your address with your payment and indicate whether it is a new subscription or a renewal. Subscription rates: qualified subscribers in the U.S.: 1 year, \$8; two years, \$12; three years, \$16. Non-qualified: 1 year, \$25. Subscription rates for foreign countries available on request.

Now...new, lower capacitance values!

Type 192P PACER[®] FILMITE[®] 'E' CAPACITORS

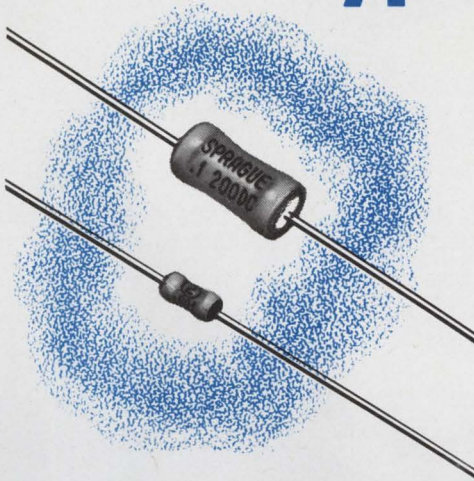

INFORMATION RETRIEVAL NO. 515

- Low-cost film capacitors with one-third the size of conventional tubulars
- Eight new low-capacitance values (100 pF thru 390 pF @ 200V) added to broad range of standard ratings
- Special construction—extended foil sections terminated in metal end caps, assuring positive contact with every turn of the electrodes
- End caps are also effective moisture barriers
- Entire assembly protected by special sleeve of high dielectric strength
- Request Engineering Bulletin 2066B

4SC-0105R1

...need a reliable wirewound resistor?

Specify ACRASIL[®] PRECISION/POWER RESISTORS

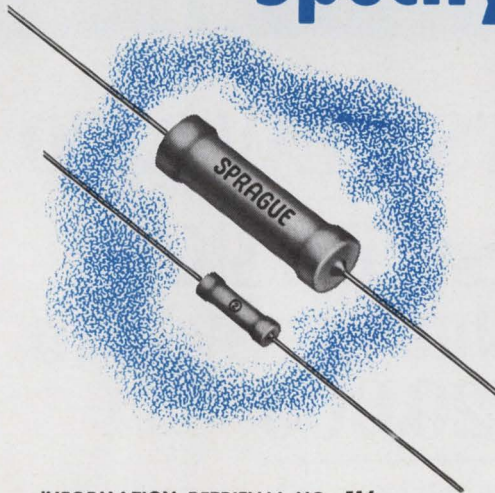

INFORMATION RETRIEVAL NO. 516

- Excellent stability and reliability, even under extended load life, extremely high humidity, and other adverse operating conditions
- Expansion coefficient of silicone coating is closely matched to that of ceramic base to insure against damage to resistance winding
- Coating provides exceptional protection against moisture, shock, vibration, fungus
- Available with standard and non-inductive windings
- Resistance tolerances as close as $\pm 0.05\%$
- Request Engineering Bulletins 7450A and 7450.1

4SR-8118R2

For Engineering Bulletins as noted above, write to:
Technical Literature Service, Sprague Electric Co., 35
Marshall Street, North Adams, Massachusetts 01247.



'Sprague' and '®' are registered trademarks of the Sprague Electric Co.

THE BROAD-LINE PRODUCER OF ELECTRONIC PARTS



low cost group therapy

WANG'S NEW 3300 The First "BASIC" Time Sharing System Under \$20,000

The 3300 is a time sharing mini-computer system for only $\frac{1}{4}$ the cost of subscription services or other in-house time sharing systems. That, in itself, is very therapeutic. And any anxieties about communicating with a computer can be eliminated by BASIC. The popular conversational language, ideal for beginners and experts alike. It's simple to get involved with a 3300. Begin a system with just one terminal if you like. Then add hardware as needed to accommodate up to 16 users, or to broaden system capability. It's truly mind expanding.



WANG LABORATORIES, INC.
Dept. 3C1, 836 North St., Tewksbury, Mass. 01876
Tel. (617) 851-7311

- Please send more information on the 3300. I want to know how much it can help me in the final analysis.
- Please send a price quotation on a _____ user system.

NAME/TITLE _____
 ORGANIZATION _____
 ADDRESS _____
 CITY _____ STATE _____ ZIP _____

Who's Who in this issue



Kniss



Borden

A pair of contributions went into the economical display described in the article that begins on page 126, with Howard C. Borden doing the circuit development and Richard D. Kniss contributing his knowledge of applications. Borden, a four-year veteran at Hewlett-Packard Associates, is a senior display scientist with a long, varied career in electro-optical R&D, including tours of duty at Stanford Research Institute and Fairchild Semiconductor. Kniss has been with H-P since 1968. He has handled internal sales and was a sales engineer for the eastern region. Now he is in charge of display product marketing.



Kupsky

Holz

Harmon

Efficiency expert is a title that could apply to William J. Harmon Jr., author of the article that starts on page 120. An applications engineer with Burroughs' Electronics Components division, his job was to design the efficient means of addressing and driving display cells described. The display itself was developed by George Holz and James Ogle, while George Kupsky was responsible for the overall panel design.

Enthusiasm is a strong point with Roger Kenneth Field, special projects editor, who is the author of the article on the future plans of the RCA Corp. starting on page 88. He tackled it with the same zeal he applied to the special report on communications [*Electronics*, Nov. 24, 1969, page 73]. Not to be outdone, *Electronics* staffers George Weiss, James Brinton, and Owen Doyle provided their maximum efforts for the IEEE Show product-planning feature beginning on page 112.



Buckwalter

Marketing and memories make a perfect pair of interests for Jack Buckwalter, who wrote the article beginning on page 108. He's product marketing chief at Ferroxcube Systems and worked at Barnhill Associates Sperry-Utah, and Bell Labs.

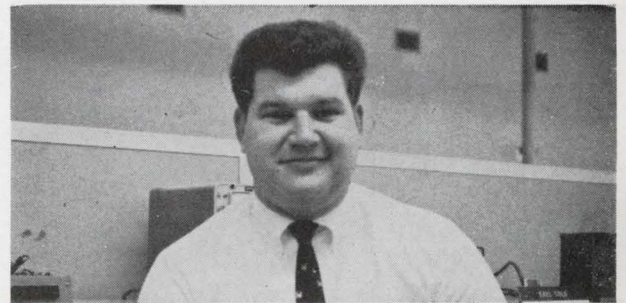

Gill

A five-year veteran of Monsanto Co., Richard T. Gill, author of the article that begins on page 132, has made light-emitting diodes his consuming interest. Gill now is working on schemes for zero suppression and decimal-point positioning.

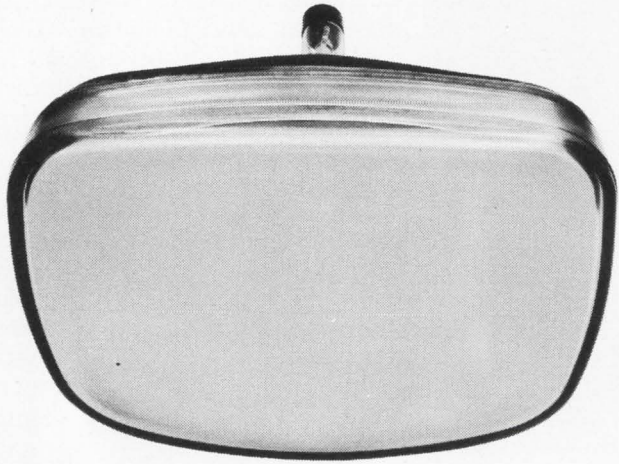

CRT Tubes—buy the components and build the display system you need.

Minimum



CRT Terminals—buy the full-scale system and get more than you need.

Maximum

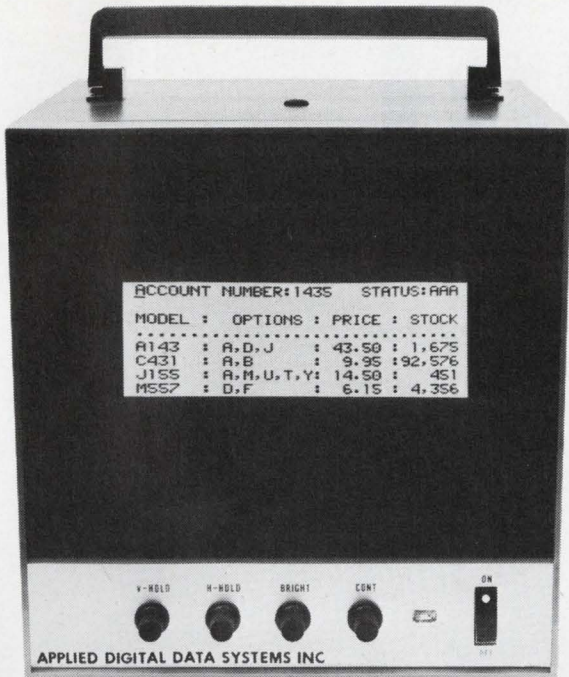

New CRT Readout—buy exactly what you need and pay less to get it.

Optimum

Announcing the MRD-200—a new, low-cost way to display alphanumeric data using TV monitors.

Now there's a practical way to read out alphanumeric data from computers, keyboards, magnetic tapes or any other sequential source.

The MRD-200 accepts ASCII data, stores it in its own memory, converts it to a composite video signal and displays it on any 525-line TV monitor. In from 32

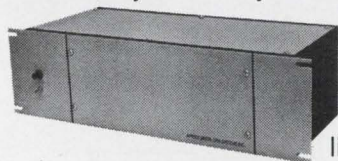

to 1024 character positions in 1, 2, 4, 8, or 16 lines with either 32 or 64 characters per line. Data may be

displayed on any number of monitors at any number of locations with just a single coaxial cable.

Cost for an MRD-200, not including monitors, starts at \$1250.

Control features let you advance to any line or character position, blink any character or combination of characters on and off, use a cursor symbol for tracking the location of the next character, and erase all or part of the screen.

The MRD is also available in other configurations. The MRD-500, for example, can read as well as write, and has random access capability. Thus, it's ideal for custom-designed display systems.

So if you have an alphanumeric display problem in process control, test equipment, data acquisition, computer consoles or data transcriber displays, you no longer have to go to extremes.

Now there's a happy medium.

From the company that specializes in innovative data communications systems.

ADDS
Applied Digital Data Systems, Inc.

Mr. Richard Kaufman, Dept. 18
Applied Digital Data Systems, Inc.
89 Marcus Boulevard
Hauppauge, New York 11787

Please send more information about the MRD-200.

Name _____

Title _____

Company _____

Address _____

City _____

State _____ Zip _____

Equal

Gates

DM8000N (SN7400N)	Quad 2-Input NAND gate
DM8001N (SN7401N)	Quad 2-Input NAND gate (Open Collector)
DM8002N (SN7402N)	Quad 2-Input NOR gate
DM8003N (SN7403N)	Quad 2-Input NAND gate (Open Collector)
DM8004N (SN7404N)	Hex inverter
DM8005N (SN7405N)	Hex inverter (Open Collector)
DM8010N (SN7410N)	Triple 3-Input NAND gate
DM8020N (SN7420N)	Dual 4-Input NAND gate
DM8030N (SN7430N)	Eight-Input NAND gate
DM8040N (SN7440N)	Dual 4-Input buffer
DM8050N (SN7450N)	Expandable Dual 2-Wide, 2-Input AND-OR-INVERT gate
DM8051N (SN7451N)	Dual 2-Wide, 2-Input AND-OR-INVERT gate
DM8053N (SN7453N)	Expandable 4-Wide, 2-Input AND-OR-INVERT gate
DM8054N (SN7454N)	Four-Wide, 2-Input AND-OR-INVERT gate
DM8060N (SN7460N)	Dual 4-Input expander
DM8086N (SN7486N)	Quad Exclusive-OR-gate

Flip Flops

DM8540N (SN7472N)	MASTER-SLAVE J-K flip flop
DM8501N (SN7473N)	Dual J-K MASTER-SLAVE flip flop
DM8500N (SN7476N)	Dual J-K MASTER-SLAVE flip flop
DM8510N (SN7474N)	Dual D flip flop

Counters

DM8530N (SN7490N)	Decade counter
DM8532N (SN7492N)	Divide-by-twelve counter
DM8533N (SN7493N)	Four-bit binary counter
DM8560N (SN74192N)	Up-down decade counter
DM8563N (SN74193N)	Up-down binary counter

Decoders

DM8840N (SN7441AN)	BCD to decimal nixie driver
DM8842N (SN7442N)	BCD to decimal decoder

Miscellaneous

DM8550N (SN7475N)	Quad latch
DM8283N (SN7483N)	4 Bit Adder
DM8850N (SN74122N)	9601-type one shot multivibrator

Spec-for-spec. Pin-for-pin. Second source on all popular 74N.

Opportunity

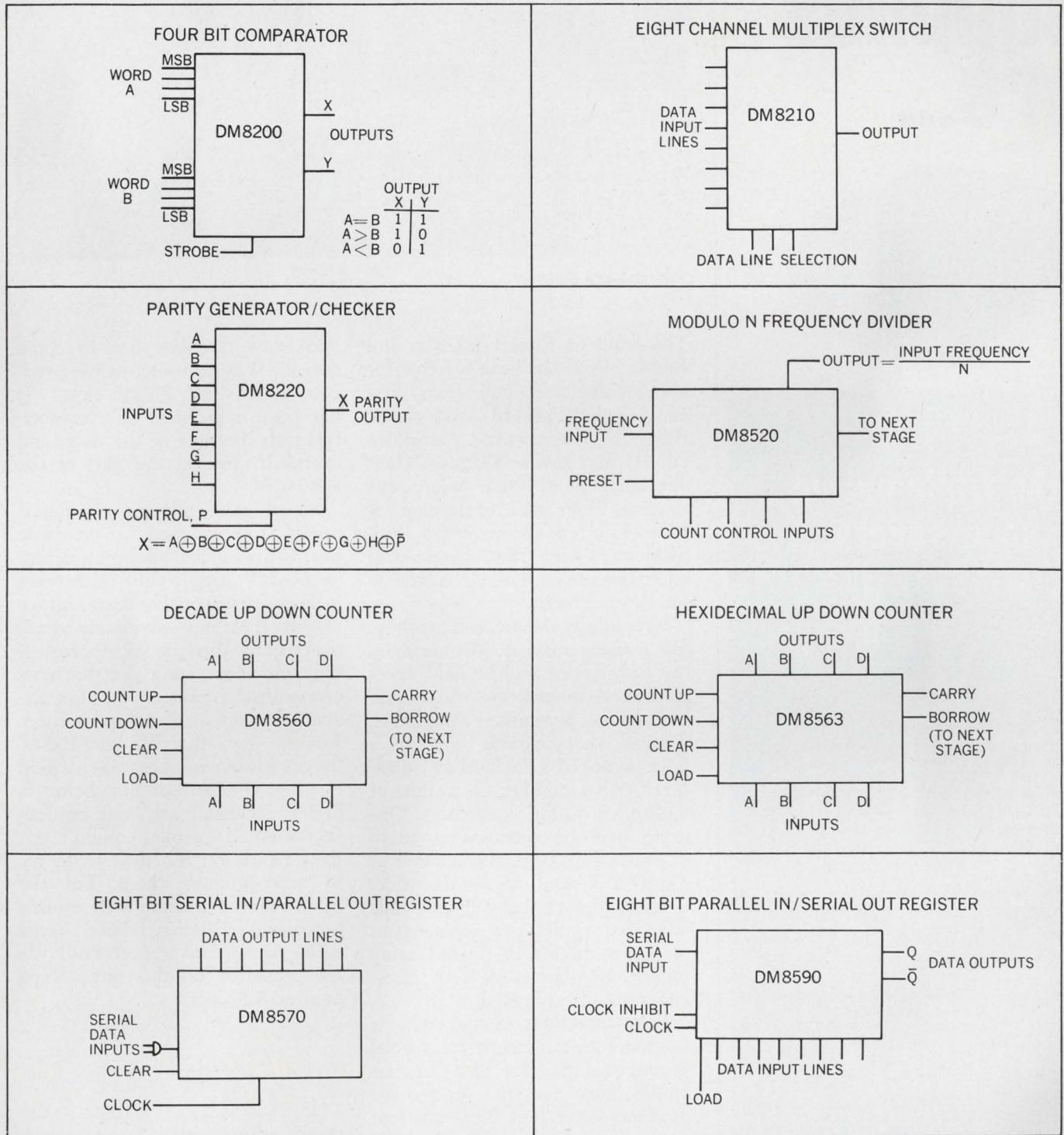

These exclusive National TTL MSI circuits offer designers increased opportunities for circuit savings in design time, board space and costs. Write or call for your free TTL Spec Guide, TTL Cross Reference Guide, and TTL Performance Tables. National Semiconductor, 2900 Semiconductor Drive, Santa Clara, California 95051 (408) 732-5000 TWX: 910-339-9240 Cable: NATSEMICON Telex: 346-353

National/TTL

TRYGON power supplies are...

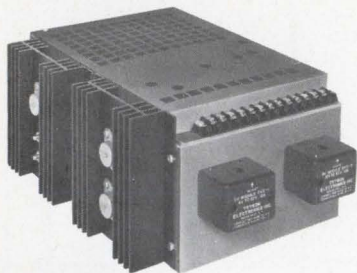

the triple output space-savers...

- Takes the place of 3 separate power supplies for IC applications, sequencing, data processing, computer peripherals, and OEM applications. Compact size — only 5" x 8" x 10".
- **Multiple Outputs:** +3.2 to +5.5VDC at 6A; +10 to +26VDC at 1.8A; -5 to -16VDC at 1.5A.
- **Special Control Circuits:** "S" option provides internal sequencing. QM501 accessory incorporates full output monitoring.
- **Rapid Delivery:** Standard off-the-shelf delivery solves your lead time problems.
- **High Reliability:** 0.05% Regulation, 2mV Ripple, 0.05% Stability, Overvoltage Protection standard on IC output, optional on other outputs.
- **Low Cost:** Economical — only \$245 in small quantities and very much lower in larger OEM quantities.
- Rack adaptable with other Trygon Systems/OEM power supplies — Liberator Sub-Rack and TPS Series, for full systems versatility.

Write or call today for our new 16-page New Product Supplement S1169 and select your power supplies for immediate delivery.

 **TRYGON POWER SUPPLIES**

111 Pleasant Avenue, Roosevelt, New York 11575
Tel: 516-378-2800 TWX: 510-225-3664
Trygon GmbH & München 60, Haidelweg 20, Germany
Prices slightly higher in Europe.

Who's Who in electronics

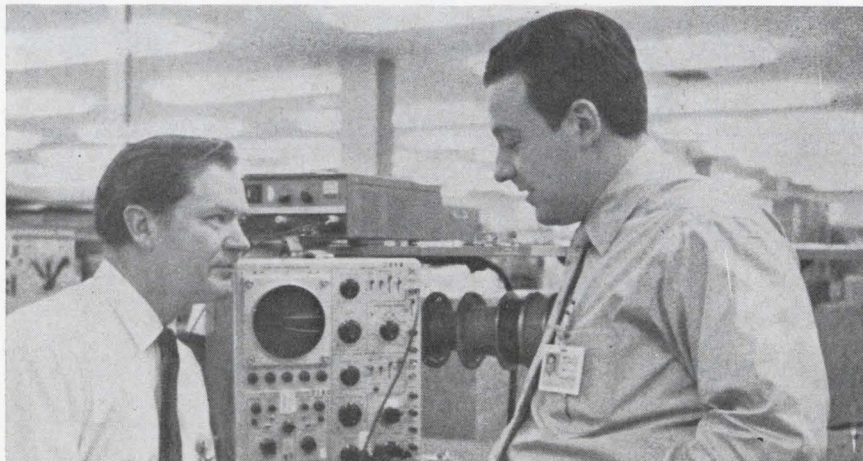

Johnson and Siegal

The team of Robert Johnson and Bernie Siegal has been together for about three-and-a-half years, first at Hewlett-Packard Associates, then at Microwave Associates (West), and now at Siliconix. Their specialty: solid state microwave devices. Their goal: to develop for Siliconix a line of microwave semiconductors for the commercial communications market, as well as for the military.

According to Johnson, whose title is microwave product manager, the first device will be field effect transistors intended as mixers and high-gain low-noise amplifiers. Typical specifications will be a noise figure of 3 decibels at 1 gigahertz. Also coming is a line of multiplier snap varactors. One group will be specified at 10 to 12 watts at 2 Ghz, and another at 1 watt at X band. Also in the works is a new device that Siliconix calls a binary varactor—a replacement for p-i-n diodes in phased array radars. Bipolar microwave transistors are also planned.

Four directions. Siegal, who is the marketing manager for special products—and who also handles applications for the microwave products—says that there are four sectors in the microwave area that are growing rapidly: communication, commercial avionics, nongovernment satellite communication, and private, closed communications systems such as cable television. "And for all of these to come about," says Siegal, "the cost of

microwave systems has to come down." Why are microwave products expensive? Siegal says, "It has been a problem of overspecifying on the part of the user, and overperfection on the part of the vendor."

Siegal says Siliconix is determined to become "a complete microwave device shopping center—we will supply all microwave markets at reasonable costs. All we ask is that our customers don't overspecify their needs, because if they do, they won't get the most economical product." As for the vendor problem of overprotection, Johnson says that "In the 1960's, the microwave market was shackled by the concept of its being a highly technical art, and production-oriented people couldn't get their hands on the devices to try to mass-produce them. But the '70's will see people without this preconceived notion taking charge—like Atalla did at Fairchild. We are going to do the same thing here at Siliconix."

How would you like to feel responsible for getting the U.S. Navy the ships it needs? That's the load on William V. Goodwin's shoulders—he's manager of RCA's Aegis program, a highly classified effort to develop a major defensive missile system for the projected DXGN, a

Beckman 136MHz \$1375.*

**Universal Counter and Timer
Fully Programmable
Field Replaceable ICs
Signal Level Indicators**

Two Counters in One • Burst Mode • Frequency • Period • Single-Channel Pulse Width & Pulse Separation • Two-Channel Time Interval • Multiple Period • Ratio • Multiple Ratio • 25 μ s Recycle Time



*** NOW! THE NEW 6401A WITH 10NSEC TIM AND PERIOD MODES...\$1875.**

Beckman®

**INSTRUMENTS, INC.
ELECTRONIC INSTRUMENTS DIVISION
RICHMOND, CALIFORNIA • 94804**

Place your order for the Model 6401 with your local Beckman representative:

Barnhill Associates • Denver, (303) 934-5505 • Albuquerque, (505) 265-7766 • Phoenix, (602) 263-1250 • Houston, (713) 621-0040 • Richardson, (214) 231-2573 • Salt Lake City, (801) 487-1327 • **BCS Associates, Inc.** • Orlando, (305) 843-1510 • Greensboro, (919) 273-1918 • Huntsville, (205) 881-6220 • Williamsburg, (707) 229-6198 • Plantation, Fla., (305) 584-7556 • **Burlingame Associates, Ltd.** • Mount Vernon, (914) 664-7530 • New York City area, (212) 933-5555 • Rockville, (301) 427-1255 • Bala Cynwyd, (215) 835-2080 • Syracuse, (315) 454-2408 • New York State, Enterprise 9-6400 • **Moxon Electronics** • Los Angeles, (213) 272-9311 • Sunnyvale, (415) 734-4352 • San Diego, (714) 274-6525 • **Pivan Engineering** • Chicago, (312) 539-4838 • Cedar Rapids, (319) 365-6635 • Mission, Kansas, (913) 722-1030 • Indianapolis, (317) 253-1681 • St. Louis, (314) 872-8424 • Minneapolis, (612) 537-4501 • Brookfield, (414) 786-1940 • **Seatronics, Inc.** • Seattle, (206) 767-4330 • **S. Sterling Company** • Cleveland, (216) 442-8080 • Pittsburgh, (412) 922-5720 • Dayton, (513) 298-7573 • Southfield, (313) 357-3700 • **Yewell Electronic Sales, Inc.** • Lexington, (617) 861-8620 • Easton, (203) 261-2241 • **Beckman Instruments, Inc.**, Electronic Instruments Division, Richmond Operations, (415) 526-7730

INTERNATIONAL SUBSIDIARIES: AMSTERDAM; CAPE TOWN; GENEVA; GLENROTHES, SCOTLAND; LONDON; MEXICO CITY; MUNICH; PARIS; STOCKHOLM; TOKYO; VIENNA

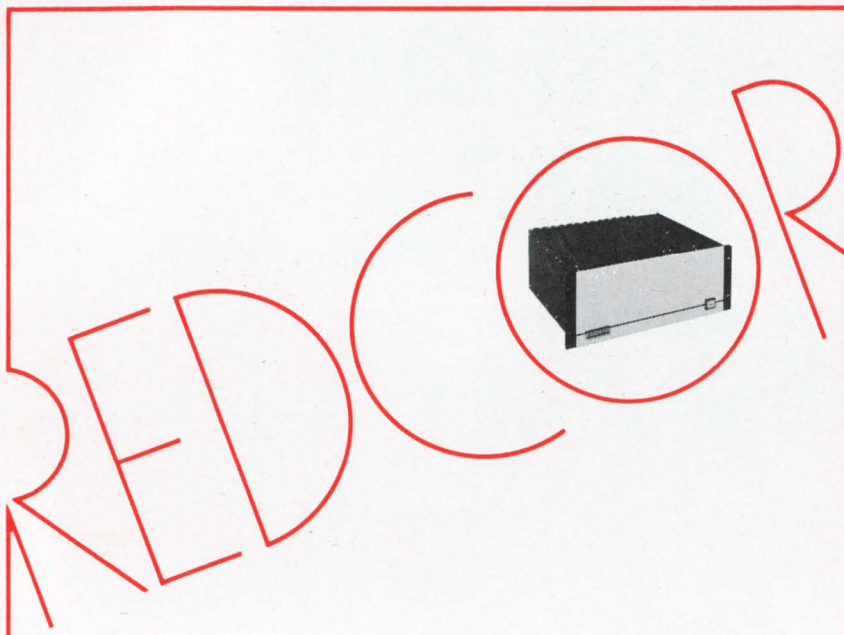

System Components From Systems Pros

The next best thing to letting REDCOR design and deliver your on-line real-time system is to do it yourself . . . using REDCOR computers, components and sub-systems. We're true professionals in the systems business and know how to make life easier for the systems designer. For example, if you're designing a high speed, low level data acquisition system, a REDCOR Model 725 low-level multiplexer analog-to-digital conversion system is a good place to start. It accepts and amplifies up to 128 channels of differential low-level data at typically *less than \$85.00 per channel!* Completely modular, the 725 needs only 7 inches of panel space in a 19" rack. It multiplexes and digitizes three-wire analog inputs ranging from $\pm 10\text{mv}$ to $\pm 500\text{mv}$ full scale. The 725 is only one of REDCOR's full line of compatible system components — from comparators to computers. If you have a systems problem, let a REDCOR Systems Pro find the solution . . . providing everything from off-the-shelf components to a "one source, one responsibility" commitment.

R REDCOR CORPORATION
C Telephone: (213) 348-5892

See us at IEEE

Who's Who in electronics



Goodwin

new class of nuclear frigates. His reasoning: since the ships will cost more than the weapon system, the Navy simply won't fund the ships if Aegis isn't ready by 1975; to this end, RCA has a \$253 million contract.

Putting it up. Goodwin and RCA apparently weren't alone in their determination. The other two competitors for Aegis—Boeing and General Dynamics—invested considerable money beyond that furnished by the government to come up with extraordinarily detailed specifications—not, as Goodwin says, merely design goals based on brochures and emotion. In fact, to make certain that every dollar invested in the program does its job, the Navy negotiated with three competitors after bids were submitted last April until RCA won the contract at the end of the year.

As for the technology destined to go into Aegis—which is to protect the fleet against air attacks and air-to-surface intruders—the word is "low risk." Goodwin says, a bit wistfully:

"High-powered solid state microwave devices would be good to have because in the Aegis world we're talking about phased-array radar whose radiated power will be in the thousands of kilowatts. But we're talking about many units per phased array, meaning packaging and heat-dissipation problems.

"But solid state isn't the way we're going—we're committed to a shipbuilding program, and that means using the best we have at present. The technology now is confined to power-generating devices like cross-field amplifiers."

Datapulse is making waves.

Big or little, one channel or two, FM or AM, square, triangular, sine or swept, the new family of Datapulse function generators makes better waves. What's more, we've put a couple of new ideas to work in the design so that you get more \sphericalangle for your \$\$\$.

The little beauty on top, the Datapulse Model 401, sells for only \$395 and gives you a dial accuracy of one percent (that's about twice as good as the competition). Frequency is 0.02 Hz to 2 MHz, and sine distortion

is only 0.25 percent in the audio range. Square-wave rise time is a

fast 40 nanoseconds. To handle low levels, we give you 80 db dynamic amplitude range.

You can field calibrate the 401 with a screwdriver, and we give you a calibrated 1V p-p square wave out for scope work. A switchable 40 db attenuator and your choice of 50 or 600 ohms output impedance further simplifies your life. You get 1000:1 voltage control, too.

The other unit, the one with all the buttons, bells and whistles, is the elegant and sophisticated Model 410. It takes up where the 401 leaves off.

Frequency is 0.0002 Hz to 2 MHz. Dial accuracy is 1%. Uniquely among function generators, the 410 allows you to both AM and FM outputs for an extra dimension in wave generation. A built-in triggerable sweep generator gives complete flexibility using either or both of the independently controllable 40V p-p output channels to generate sine, square, triangle, sawtooth, and swept waves. Price is a modest \$995.

To arrange a demonstration or obtain more data, contact your local S-D man. Or address Datapulse Division, Systron-Donner Corporation, 10150 W. Jefferson Blvd., Culver City, California 90230. Phone (213) 836-6100.



DATAPULSE
DIVISION

SYSTRON  DONNER

Circle 17 on reader service card

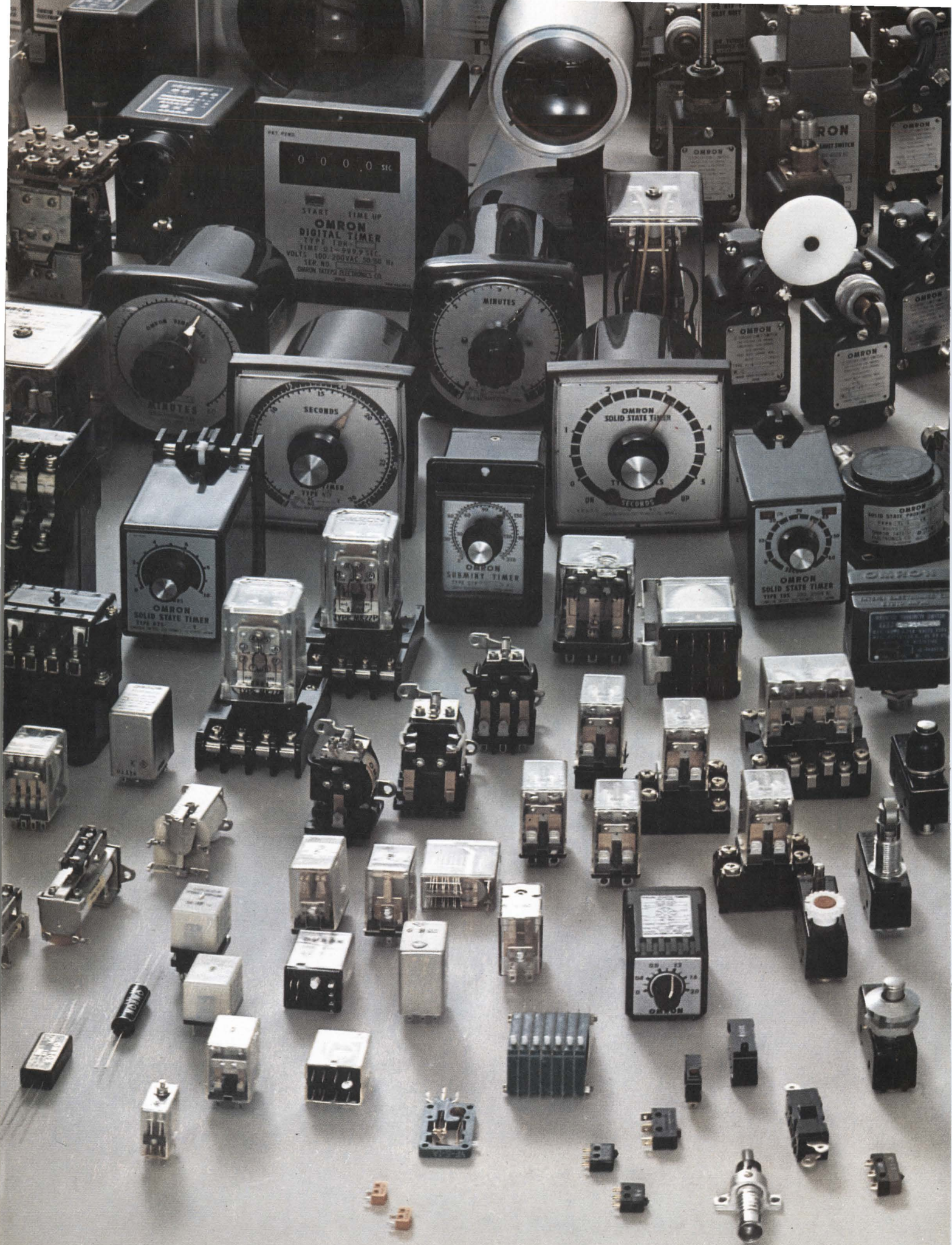



OMRON and the '70s. Showing off again.

It's IEEE showtime again. Last year, Omron's extraordinary magnetic-card vending systems had their debut. Rave notices. Now they're in use from coast to coast. This year, you'll find an extravaganza of precision control components plus a new magnetic input switch that's something else.

And if you ask, you'll be told (in fluent English) how our unique R&D system made us Japan's and the world's largest multi-controls specialist. The project-integrating Omron R&D system is freely adapted from MIL-Q5923C and abbreviates as PESIC.

Combining it with our talented young engineering brains has resulted in a full width range of components unequaled for quality and straight ingenuity of design. And where required, each control carries UL, CSA, SEC and SECV international authorization.

Roll up and see them at the Omron booth. Reservations are not necessary.

IEEE Show booth No. 3B-40, 42

Components, Control Devices, Systems. An original world of electronics.



OMRON TATEISI ELECTRONICS CO.

SALES OFFICE/Toa Bldg., 5, Yonban-cho, Chiyoda-ku, Tokyo, Japan
Phone (265) 4611 Telex 232-2179 Cable Address OMRONELCO TOKYO
OVERSEAS DISTRIBUTORS: ● AUSTRALIA/H.Rowe & Co., Pty., Ltd.
● AUSTRIA/Carlo Gavazzi-Billman G.m.b.H. ● ITALY/Carlo Gavazzi S.p.A.
● BELGIUM/Carlo Gavazzi Belgium s.a. ● ENGLAND/Keyswitch Relays Ltd.
● FORMOSA/kai Nan Trading Co., Ltd./Sheng Ching Trading Co., Ltd.
● FRANCE/Billman-Carlo Gavazzi S.A.R.L.
● HOLLAND/Carlo Gavazzi-Billman Nederland N.V.
● SPAIN/Carlo Gavazzi-Reguladores Billman s.a. ● MEXICO/Schultz Y Cia., S.A.
● SWEDEN/Billman Regulator ab. ● SWITZERLAND/Carlo Gavazzi-Billman AG.
● U.S.A./Sigma Instruments Inc. ● SOUTH AFRICA/P.J.Yelland & Co. (Pty) Ltd.
● WEST GERMANY/Carlo Gavazzi-Billman Industriezulieferung G.m.b.H.

When you're really serious about MSI family planning,

To make a Quad Latch that's both R/S and D compatible,



Fairchild's new MSI 9314 Quad Latch is a versatile, high-speed device that can be used in any application requiring a single-input D-type latch or an R/S-type latch. It has no undefined states in the R/S mode. Its unique multi-function capabilities make it useful in a number of applications: four-bit storage latches, contact bounce eliminators, multi-input active high set/reset latches, counting and holding display systems, eight-bit addressable latches, A/D conversions, zero and ones catching storage.

The addition of this device to our MSI family gives you everything you need for just about any latching application you could name. Use the new 9314 for maximum function versatility. Or the 9308 Dual Four-Bit Latch when minimum package count is most important. Your Fairchild Distributor has complete specs on both MSI devices.

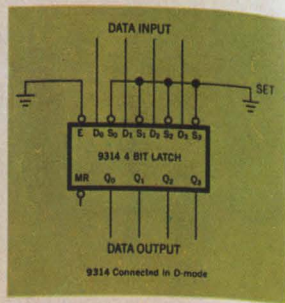

To order the 9314, ask for

PART NUMBER	PACKAGE	TEMPERATURE RANGE	PRICE (100)	PRICE (1000)
U9314A1X	DIP	-55°C to +125°C	\$19.40	\$13.00
U9314A10N	DIP	-55°C to +70°C	\$18.30	\$12.50
U9314A1XN	Flat	-55°C to +125°C	\$17.85	\$12.30
U9314A10XN	Flat	0°C to +70°C	\$16.20	\$11.50

To order the 9308, ask for

PART NUMBER	PACKAGE	TEMPERATURE RANGE	PRICE (100)	PRICE (1000)
U9308A1X	DIP	-55°C to +125°C	\$25.40	\$17.00
U9308A10N	DIP	-55°C to +70°C	\$23.20	\$15.50
U9308A1XN	Flat	-55°C to +125°C	\$22.60	\$15.20
U9308A10XN	Flat	0°C to +70°C	\$19.50	\$13.50

you have to get serious about MSI family planning.

We put together a family plan by taking systems apart. All kinds of digital systems. Thousands of them.

First we looked for functional categories. We found them. Time after time, in a clear and recurrent pattern, seven basic categories popped up: Registers, Decoders and demultiplexers, Counters, Multiplexers, Encoders, Operators, Latches. Inside each of the seven categories, we sifted by application. We wanted to design the minimum number of devices that could do the maximum number of things. That's why, for example, Fairchild MSI registers can be used in storage, in shifting, in counting and in conversion applications. And you'll find this sort of versatility throughout our entire MSI line.

Finally, we studied ancillary logic requirements and packed, wherever possible, our MSI devices with input and output decoding, buffering and complementing functions. That's why Fairchild MSI reduces in many cases eliminates the need for additional logic packages.

The Fairchild MSI family plan. A new approach to MSI that's as old as the industrial revolution. It started with functional simplicity, extended through multi-use component parts, and concluded with a sharp reduction in add-ons. Simplicity. Versatility. Compatibility. Available now. In military or industrial temperature ranges. In hermetic DIPs and Flatpaks. From any Fairchild Distributor.



REGISTER
9300 - Dual 4-Bit Register
9302 - Dual 8-Bit Register



LATCHES
9308 - Dual 4-Bit Latch
9314 - Quad Latch



MULTIPLEXERS
9309 - Dual 4-Bit Multiplexer
9310 - Dual 8-Bit Multiplexer



DECODERS
9311 - Binary Decoder
9312 - Binary Decoder



ENCODERS
9313 - Binary Encoder
9314 - Binary Encoder



COUNTERS
9301 - Binary Counter
9302 - Binary Counter



DEMULTIPLEXERS
9303 - Dual 4-Bit Demultiplexer
9304 - Dual 8-Bit Demultiplexer

Nobody makes MSI the way Fairchild does.



FAIRCHILD SEMICONDUCTOR A Division of Fairchild Camera and Instrument Corporation Mountain View, California 94035 (415) 962-6011 TWX 910-270-6938

Fairchild's MSI family plan started with the 9300 Series. Highly versatile, highly compatible devices in seven functional categories: Registers. Decoders and demultiplexers. Counters. Multiplexers. Encoders. Operators. Latches. A minimum number of devices that do a maximum number of things. (Like a register that shifts, counts, stores and converts.)

you don't stop at one family.

Now Fairchild has a new family. Low power MSI. The 9200 Series. All the versatility of the 9300s at 1/4 the power. But low power doesn't mean low speed. Fairchild's new family operates at 5MHz — ideal for military, avionics and industrial low-power, minimum-space applications.

The 9200 family typically features 2mW/gate with 20nsec/gate delay for the optimum trade-off between speed and power. Devices come in both DIPs and Flatpaks. The first six of the economical low-power devices are already in inventory. You can get them today at any Fairchild Distributor.

Here are the first six:

- + 9200 — 4-Bit Register
- 9208 — Dual 4-Bit Latch
- 9209 — Dual 4-Bit Digital Multiplexer
- 9211 — 1-of-16 Decoder
- 9212 — 8-Input Digital Multiplexer
- 9228 — Dual 8-Bit Shift Register



OPERATORS



REGISTERS

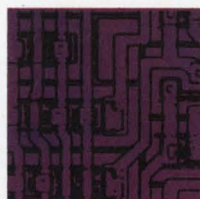

DECODERS AND DEMULTIPLEXERS

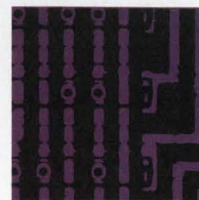

MULTIPLEXERS



COUNTERS

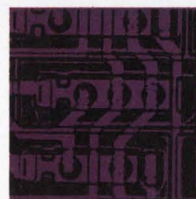

ENCODERS



LATCHES

FAIRCHILD
SEMICONDUCTOR

EUTECTIC PREFORMS

for semiconductor assembly



with quality service to match quality products

CRM makes perfect preforms of eutectic alloys of Gold-Tin, Gold-Silicon, and Gold-Germanium.

CRM preforms can help you to produce perfect ICs, hybrids, transistors, and diodes. Quality is controlled from the ingot on, including not only standard tests, but also checks of foil surface finish and flow characteristics. The extensive die inventory at CRM makes most preforms available without delay and without a tooling charge.

CRM will meet your strictest specifications.

CRM delivers what it promises. CRM delivers on TIME.

Call or write CRM for a quotation on your preforms or the CRM catalog with a list of over 300 stock dies.

**CONSOLIDATED
CRM REACTIVE
METALS, INC.**

a Division of CONSOLIDATED REFINING CO. Inc.
110 Hoyt Avenue, Mamaroneck, N.Y. 10543
Tel: (914) 698-2300 □ TWX 710-566-1112

Meetings

Amid the blossoms in the capital

Engineers seeking signs of spring in Washington, D.C., will find two budding perennials following on the heels of the capital's famed Cherry Blossom Festival in mid-April. The first of these will be the Federal Aviation Administration's second annual government-industry National Aviation System Planning Review Conference; the second will be the IEEE's second annual International Geoscience Electronics Symposium. The meetings will be held April 14-19.

At the FAA conference, Secretary of Transportation John A. Volpe will unveil the agency's \$2.5 billion procurement plans for electronics systems in the 1970's to hasten the lagging development of the nation's airports and airways. FAA administrator John H. Shaffer says that the meeting will give aircraft and avionics company officials "an opportunity to shape the plans and policies which affect it most directly" by participating in seminars, where issues relating to the policies and plans for the national aviation system will be discussed.

Sorting them out. Highlighting the 14 sessions at the four-day meeting will be discussions of balancing the Department of Transportation's air traffic control recommendations for expansion of the present system, with the Air Transport Association's proposal for a new concept relying on air-derived data transmitted via data link to ground controllers and automated ground systems. A third plan for satellite use in ATC for data acquisition, navigation, and communications will also be considered in the session. New-generation instrument landing systems are scheduled for another session treating the issue of microwave scanning beam techniques, the balance between ground and airborne hardware, related costs, and compatibility with existing systems to permit an evolutionary transition.

Environmental pollution will take up two sessions of the IEEE symposium as well as provide the substance for a banquet speech by

Sen. Warren G. Magnuson (D., Wash.)

On Thursday afternoon, April 16, William Lear, president of Lear Enterprises Inc. of Stead, Nev., who recently gave up developing a new steam car to cut air pollution, will discuss "Reduction of Auto Environmental Pollution." On Friday morning, April 17, two officials of the Permutit Corp. of Monmouth, N.J., John Anderson and Charles Weiss, will tell how the electronics industry can help with "Clean Water and Pollution Control." Later Friday afternoon, a panel will wrap up the "Causes, Cures, and Cost of Pollution." Senator Magnuson will outline "The Government's Role in Environmental Protection."

Generally, the symposium sponsored by the geoscience electronics group of the IEEE will review the current status of techniques potentially applicable to the exploration and exploitation of land, sea, air, and space. Both the technical papers and the educational exhibits will focus on advancements in techniques and in the state-of-the-art hardware for measuring geophysical parameters within the previous year.

For further information on the FAA Conference contact the Office of Public Affairs (Pa-10) FAA/DOT, 800 Independence Ave. S.W., Washington, D.C. 20590.

For details of the IEEE symposium contact Michael L. Sims, National Oceanographic Instrumentation Center, Building 160, Navy Yard, Washington, D.C. 20390.

Calendar

Scintillation & Semiconductor Counter Symposium, IEEE; Shoreham Hotel, Washington, March 11-13.

International Seminar on Digital Processing of Analog Signals, IEEE; Swiss Federal Institute of Technology, Zurich, Switzerland, March 11-13.

Symposium on Management and Economics in the Electronics Industry,

(Continued on p. 24)

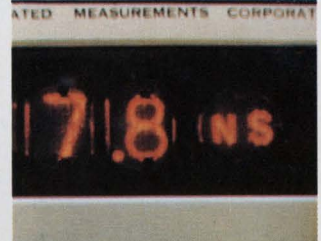
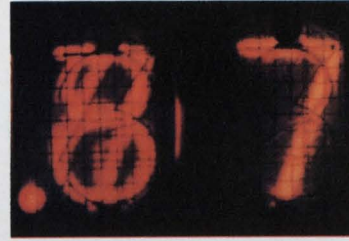
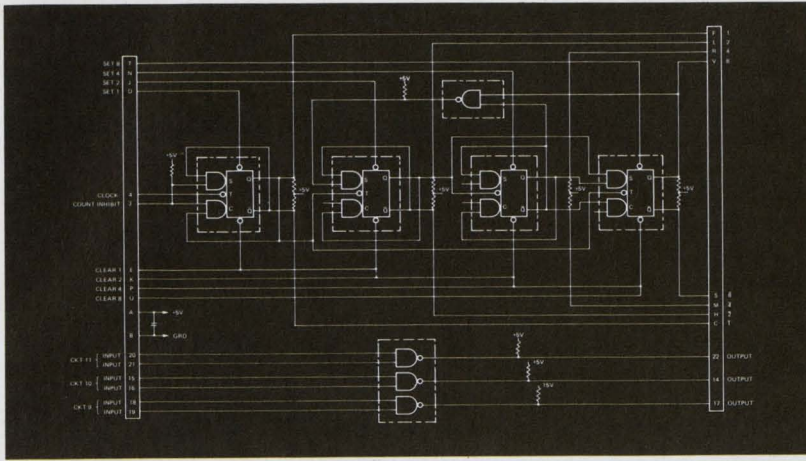

E-H the systematic solution

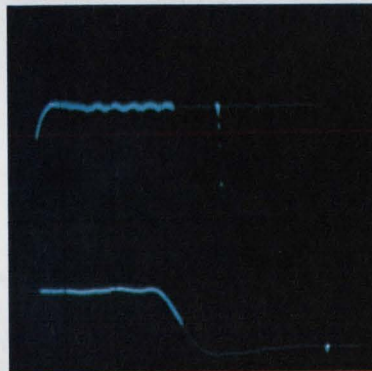

Whether you need a complete dynamic test system or the ideal components to integrate with your present system, look no further. E-H Research Laboratories, Inc. and its subsidiary, Automated Measurements Corporation, offer you the perfect solution.

For example, the **E-H 1139/1420 programmable timing unit and pulse driver combination** is a new generation in pulse instruments that fits the needs of any systems designer. These two rack-mounted units are so completely programmable that there are no front-panel knobs to twist. They're ideal for any systems applications requiring pulses from 1kHz to 10MHz. And they offer the designer such features as complete waveform control, with programmable width and delay from 10ns to 100 μ s, amplitude from $\pm 3V$ to $\pm 10V$ with programmable attenuation from X1 to X40 and rise and fall times programmable from 5ns to 13 μ s.

The perfect mate to the E-H 1139/1420 is the **AMC Model 1000 Waveform Analyzer**. The AMC 1000 was designed specifically for programmed systems application. It combines in one compact box the functions of sampling oscilloscope, digital counter and digital voltmeter to provide time and voltage measurements of sampled waveforms. The AMC 1000 is the most advanced instrument of its kind, with features including $\pm 1\%$ time measurements all ranges, fastest measurement rates, 10 remote sampling channels, all solid-state construction, serial-by-character or parallel programming, built-in program memories, stored BCD outputs, built-in floating DVM, and digital readout.

This is just a sample of the broad line of E-H and AMC equipment available from your E-H representative. He can offer you a complete system or the most advanced components to give you the systematic solution to your problems today. And tomorrow.



E-H RESEARCH LABORATORIES, INC.

515 Eleventh Street • Box 1289, Oakland, California 94604 • Phone: (415) 834-3030 • TWX 910-366-7258
 In Europe: E-H Research Laboratories (Ned) N.V., Box 1018, Eindhoven, The Netherlands, Telex 51116
 In Japan: Iwatsu Electric Company, Ltd., 7-41, 1-Chome Kugayama Suginami-Ku, Tokyo 167, Japan

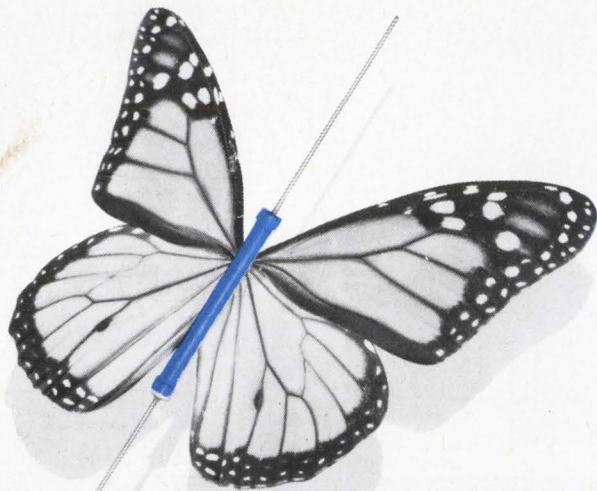

Victoreen's rare specimen!

Our MOX-1125. A rare specimen made only by Victoreen. With rare qualities in the 1-10,000 Megohm range. Rated at 1.00W @70°C. 5,000 volts maximum. Yet it's just .130" in diameter by 1.175" long.

It's one of Victoreen's Mastermox metal oxide glaze resistors. About one-half the size of competitive resistors of similar power handling capacity.

All Mastermox resistors are rare performers. Excellent stability: As little as 1% drift under full load in 2000 hours — with more than 40 watts power dissipation per cubic inch. $\pm 0.5\%$ tolerance. 10K ohms to 10,000 Megohms resistance range. Voltage and temperature cycling leaves no permanent effect. And Mastermox stays potent on the shelf — less than 0.1% drift per year.

Get Mastermox. Rare resistor performance.

Model	Resistance Range	Power Rating @ 70°C	*Max. Oper. Volts	Length Inches	Diameter Inches
MOX-400	1 - 2500 megs	.25W	1,000V	.420 ± .050	.130 ± .010
MOX-750	1 - 5000 megs	.50W	2,000V	.790 ± .050	.130 ± .010
MOX-1125	1 - 10000 megs	1.00W	5,000V	1.175 ± .060	.130 ± .010
MOX-1	10K - 500 megs	2.50W	7,500V	1.062 ± .060	.284 ± .010
MOX-2	20K - 1000 megs	5.00W	15,000V	2.062 ± .060	.284 ± .010
MOX-3	30K - 1500 megs	7.50W	22,500V	3.062 ± .060	.284 ± .010
MOX-4	40K - 2000 megs	10.00W	30,000V	4.062 ± .060	.284 ± .010
MOX-5	50K - 2500 megs	12.50W	37,500V	5.062 ± .060	.284 ± .010

*Applicable above critical resistance. Maximum operating temperature, 220°C. Encapsulation: Si Conformal. Additional technical data in folder form available upon request. Or telephone: (216) 795-8200.

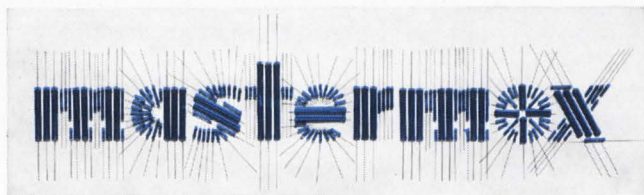

DMA 532



VICTOREEN INSTRUMENT DIVISION
 10101 WOODLAND AVENUE • CLEVELAND, OHIO 44104
 EUROPE: ARNDALE HOUSE, THE PRECINCT, EGHAM, SURREY, ENGLAND • TEL: EGHAM 4887

Meetings

(Continued from p. 22)

IEE; University of Edinburgh, Scotland, March 17-20, 1970.

International Convention, IEEE; New York Hilton Hotel and the New York Coliseum, March 23-26, 1970.

Meeting of the Association for the Advancement of Medical Instrumentation, Statler Hilton Hotel, Boston, Mar. 23-25, 1970.

Symposium on Submillimeter Waves, IEEE, Polytechnic Institute, Brooklyn, New York, March 31-April 2, 1970.

Communications Satellite Systems Conference, American Institute of Aeronautics and Astronautics; International Hotel, Los Angeles, April 6-8, 1970.

Reliability Physics Symposium, IEEE; Stardust Hotel and Country Club, Las Vegas, Nevada, April 7-9, 1970.

Meeting and Technical Conference, Numerical Control Society; Statler Hilton, Boston, April 8-10, 1970.

Computer Graphics International Symposium, IEE; Uxbridge, Middlesex, England, April 13-16, 1970.

International Geoscience Electronics Symposium, IEEE; Marriott Twin Bridges Motor Hotel, Washington, April 14-17, 1970.

USNC/URSI-IEEE Spring Meeting; Statler Hilton Hotel, Washington, April 16-19.

American Power Conference, IEEE; Sherman House, Chicago, April 21-23, 1970.

International Magnetics Conference (INTERMAG), IEEE; Statler Hilton Hotel, Washington, April 21-24, 1970.

Southwestern IEEE Conference & Exhibition; Memorial Auditorium, Dallas, April 22-24.

Annual Frequency Control Symposium, U.S. Army Electronics Command; Shelburne Hotel, Atlantic City, N.J., April 27-29, 1970.

National Telemetry Conference, IEEE; Statler Hilton Hotel, Los Angeles, April 27-30, 1970.

National Relay Conference, Oklahoma State University and the National Association of Relay Manufacturers; Oklahoma State University, Stillwater, April 28-29, 1970.

Transducer Conference, IEEE;

(Continued on p. 26)

Clean as a hound's tooth ain't clean enough...



If unaggressive cleaners are using more bark than bite on your product, you can be doggone sure of one thing. Product reliability needs

Branson Ultrasonic Cleaning

Any product that can be placed in a tank can be cleaned or degreased consummately preparatory to plating, painting or finishing by Branson's ultrasonic cleaning systems. Every part of the part, every crevice and cranny is flushed clean by millions of imploding bubbles generated ultrasonically.

For mechanical or cosmetic cleaning to insure product reliability, Branson has a capacity from a quart to a vat full. Come clean. Are you hounded by doubt now?

Branson Instruments Co.
a subsidiary of Smith Kline & French Laboratories
Progress Drive, Stamford, Connecticut 06904

Pin-sized microcircuit
by Signetics Corp.
cleaned *absolutely* by
Branson ultrasonics.

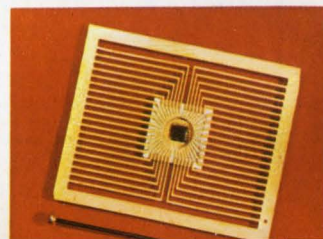

Circle 25 on reader service card

If you must measure Torque

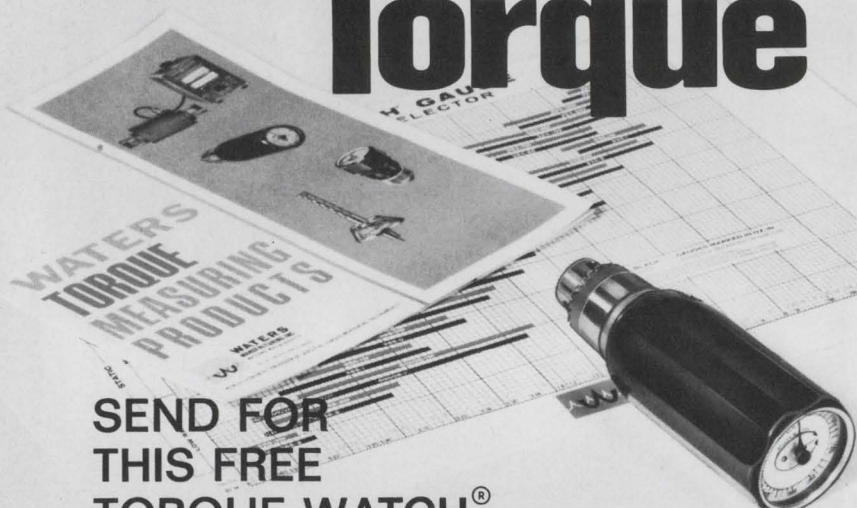

SEND FOR THIS FREE TORQUE WATCH® GAUGE SELECTOR CHART and CATALOG from WATERS

World's foremost producer of sensitive torque measuring instruments

Get this unique guide for selecting the exact torque measuring gauge for your specific requirement.

Waters produces 40 separate low range torque measuring devices — static and dynamic — for measuring static torque from 0.003 to 200 oz. in.; for measuring dynamic torque from 5 to 500 oz. in. Available with calibration in English or Metric Units. Whether you test for production, quality control or development, only Waters can assure you the sensitivity, precision and instant readout you need in measuring any force, effort or strain.

Write today for your FREE Waters Torque Watch Gauge Selector Chart and Catalog.

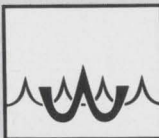

WATERS MANUFACTURING, INC.

—WAYLAND, MASSACHUSETTS 01778

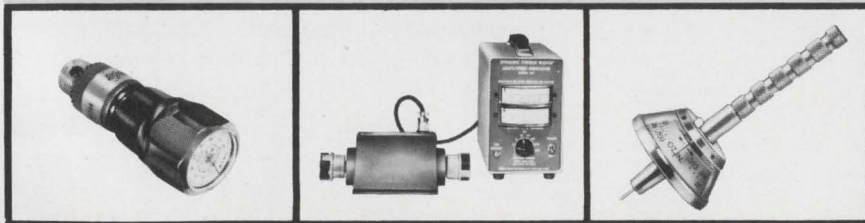

Meetings

(Continued from p. 24)

National Bureau of Standards, Washington, May 4-6, 1970.

Aerospace Power Conditioning Specialists Conference, IEEE; Royal Pines Motel, NASA, Greenbelt, Md., April 20-21. Industrial and Commercial Power Systems and Electric Space Heating & Air Conditioning Joint Technical Conference, IEEE; Jack Tar Hotel, San Francisco, May 4-7.

Safety in Research and Development, National Safety Council and the American Society of Safety Engineers; Cambridge, Mass., May 4-5.

National Appliance Technical Conference, IEEE; Leland Motor Hotel, Mansfield, Ohio, May 5-6, 1970.

Spring Joint Computer Conference, IEEE; Convention Hall, Atlantic City, N.J., May 5-7.

Midwest Symposium on Circuit Theory, IEEE and the University of Minnesota; University of Minnesota, Minneapolis, May 7-8.

Aerospace Instrumentation Symposium, Instrument Society of America; Washington Plaza Hotel, Seattle, May 11-13.

International Microwave Symposium, IEEE; Newporter Inn, Newport Beach, Calif., May 11-14.

Electronic Components Conference, IEEE and the Electronic Industries Association; Statler-Hilton Hotel, Washington, May 13-15.

Short courses

Computer-Aided Automation—The Evolution of, Department of Engineering, University Extension; University of Wisconsin, May 5-6. \$70 fee.

Eighth Annual Seminar on Solid State, Department of Engineering, University Extension; University of Wisconsin, May 12-13. \$70 fee.

Research and Development, Department of Engineering, University Extension; University of Wisconsin, May 14-15. \$70 fee.

Laser Fundamentals and Communications; Rice University, Houston, Texas, May 4-6. \$300 fee.

System Engineering, Engineering and Physical Sciences Extension; University

(Continued on p. 28)

Would the engineer who asked us to design a marking system to serialize on an electronic praying mantis, please call (603) 352-1130.

It's ready.

If for some strange reason you're not making electronic praying mantises, how about your transistors, IC's, SCR's, diodes, thyristors or whatever. We can handle those, too.

We've got the systems, typefaces, inks, supplies and services to mark whatever you make, and mark it right.

Our problem-solver booklet will tell you more about us.

Write for it now.

(before you go bugs)

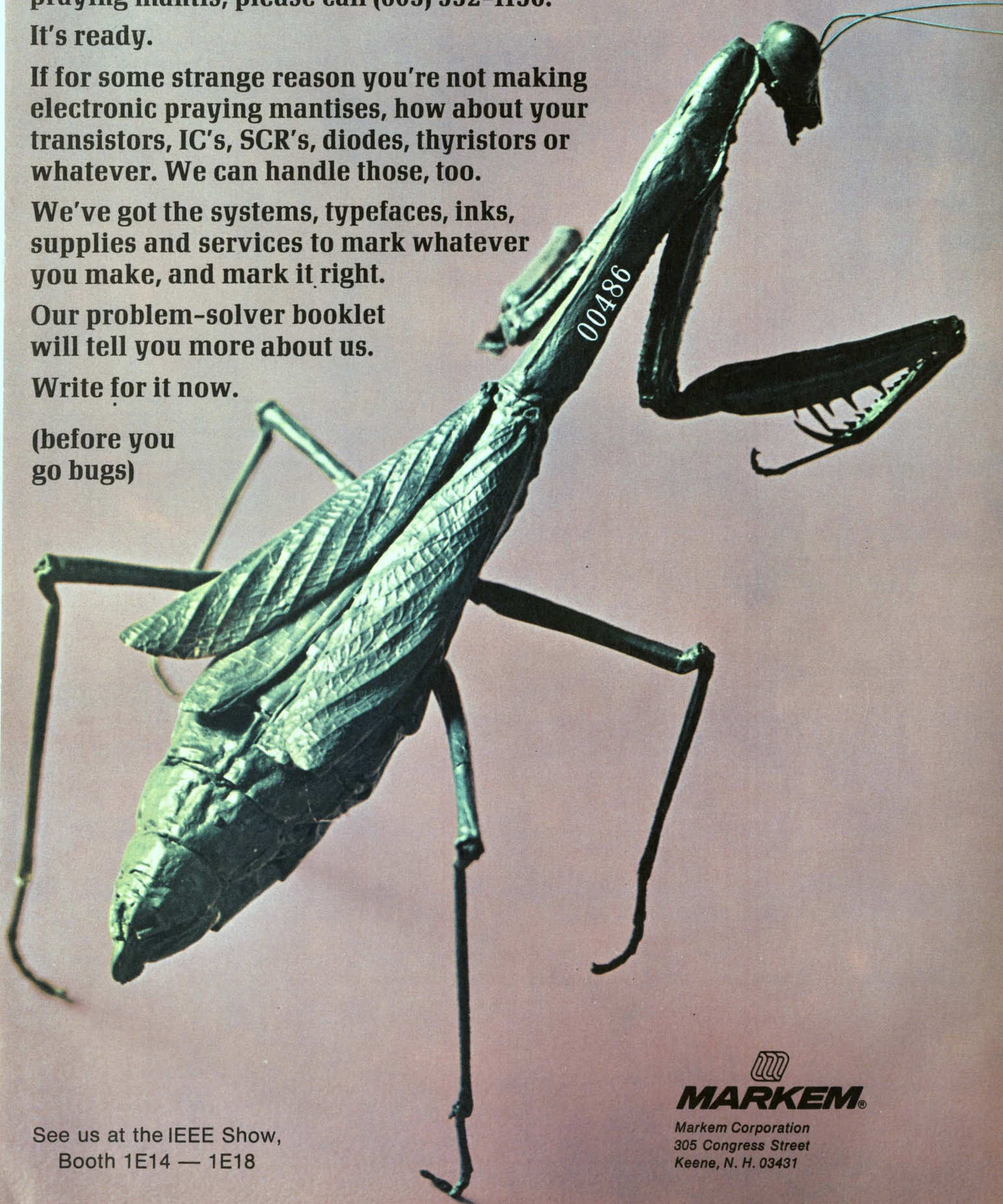

See us at the IEEE Show,
Booth 1E14 — 1E18

MARKEM®

Markem Corporation
305 Congress Street
Keene, N. H. 03431

Crisp Bacon in 90 Seconds

with INTERNATIONAL'S
MICROWAVE OVEN



The culinary wonder of space age cooking moves to your kitchen with this new International countertop oven that cooks with radar-spawned microwave power.

People on the go will welcome an oven that makes cooking chores a pleasure. Imagine a "piping hot" TV dinner (frozen) in 3½ minutes* instead of 20 to 50 minutes. Bake a potato in 5 minutes instead of 60 minutes. Warm a chilled baby bottle in 60 seconds. Fry crisp bacon in 90 seconds on a paper plate. Great for those leftovers.

International Microwave Oven is truly remarkable. No more waiting for the oven to reach cooking temperature.

Countertop designed for the home, mobile home, or the galley on your boat. No special wiring required. Works on 115 vac house circuit. **\$695.00**

Available direct from International or through your local appliance dealer.

**Times listed are approximate and vary with size of item.*

Write for folder



CRYSTAL MFG. CO., INC.

10 NO. LEE • OKLA. CITY, OKLA. 73102

Meetings

(Continued from p. 26)

of California at Los Angeles, April 20-24. \$285 fee.

Electrical Engineering Refresher, Department of Engineering, University Extension; University of Wisconsin, April 23-25. \$50 fee.

Systems Engineering Management, Engineering and Physical Sciences Extension; University of California at Los Angeles, April 27-May 1. \$285 fee.

Modern Filter Synthesis Techniques, University Extension; Boelter Hall, Room 4442, University of California at Los Angeles, April 27-May 1. \$285 fee.

Call for papers

Symposium on switching and Automata Theory, IEEE; Santa Monica Calif., Oct. 28-30. **May 15** is deadline for submission of abstracts to Professor Peter Weiner, Department of Computer Science, Dunham Laboratory, Yale University, New Haven, Conn. 06520.

Conference on Engineering in Medicine and Biology, Alliance for Engineering in Medicine and Biology; Nov. 15-19. **June 1** is deadline for submission of abstracts to William T. Maloney, Conference Coordinator, 1970 ACEMB, 6 Beacon St., Suite 620, Boston, Mass. 02108.

Northeast Electronics Research and Engineering Meeting (NEREM), IEEE; Sheraton Boston Hotel and the War Memorial Auditorium, Boston, Nov. 4-6. **July 1** is deadline for submission of papers to Program Chairman, IEEE NEREM-70, 31 Channing St., Newton, Mass. 02158

International Symposium on Circuit Theory, IEEE; Sheraton-Biltmore Hotel, Atlanta, Georgia, Dec. 14-16. **June 1** is deadline for submission of abstracts to I.T. Frisch, Network Analysis Corp., Beechwood, Old Tappan Road, Glen Cove, N.Y. 11542

International IEE/G-AP Symposium; Ohio State University, Columbus, Sept. 14-16. **June 1** is deadline for submission of papers to Dr. Curt A. Levis, P.O. Box 3115, Ohio State University, Columbus 43210

Fall USNC/URSI Meeting; Ohio State University, Columbus, Sept. 15-17. **June 22** is deadline for submission of papers to Dr. Curt A. Levis, P.O. Box 3115, Ohio State University, Columbus 43210



Trust your Guardian Angel

for the newest 4PDT—5amp miniature relay

Give us a cubic inch on your printed circuit board . . . and we'll fill it with a plug-in relay. The logical relay for logic systems, computers, business machines—any application requiring maximum endurance and reliability in minimum space. Our new 1310, 4PDT-5 amp miniature relay is just a little more than one cubic inch in size, with inductive load contact rating of $\frac{1}{8}$ hp @ 120V 60 Hz. But the small size doesn't limit its mechanical life of 100 million operations DC, 50 million AC. Minimum!



The miniature size doesn't limit its versatility, either. It's available with a choice of solder lug, quick connect .110, or printed circuit terminals—sockets for "plug-in" installation available with PC or solder lug. Other features like AC and DC versions, the Lexan dust enclosure that's standard, plus U/L and CSA recognition make this relay the answer to an engineer's prayers. (And all this time you didn't really believe you had a Guardian Angel!)



**GUARDIAN[®]
ELECTRIC**

MANUFACTURING COMPANY • 1550 West Carroll Avenue, Chicago, Illinois 60607



COMPLETE APPLICATION DATA is yours for the asking. Send for Bulletin B5-1.

Talk to your Guardian Angel at the IEEE Show.



Judge a book by its cover.

This is not always advisable. But sometimes the public has no choice. Take the case of Panasonic. Ask a dozen people on the street about us. The response is likely to be, "They make radios, TV's, tape recorders and phonographs."

True. But that's only the end result. A small portion, at that. Few know the story behind the products. And fewer still know the unusual, unbelievable, yet very real philosophy of the Company: Peace and Happiness through man's physical, moral and spiritual Prosperity. What's between the covers? 2,500 scientists doing research in 14 laboratory complexes. 45,000 technicians plying their skills in 85 ultra-modern manufacturing facilities.

Radios? Yes, plus over 4,500 other consumer, industrial and commercial products, marketed in over 120 countries. And something

even more unique. The fact that we make each and every vital component of every single product we manufacture. Permitting us to make Quality Control an exact science, not a jig-saw puzzle.

Innovative Panasonic products purchased today represent "yesterday" to our research staff. For they are occupied with making reality out of tomorrow's dreams and fantasies. Developing television sets that fit in the palm of your hand. Or hang flat on your living room wall. Designing complete stereo music centers that you wear on your head. Conceiving a mosaic lighting system that will revolutionize visual communications. Devising video tape recorders that teach surgery to doctors and the ability to communicate to the deaf.

Each year, at the IEEE exhibition, we take great pride and pleasure in sharing with you the fruits of

our labor... the achievements which we sincerely hope will better the lives that all of us lead. We are particularly proud this year.

On display, for the first time anywhere, will be the Panasonic 2" Video Tape Printer. We believe it to be the solution to one of the most vexing problems which has faced the communications industry today: How to duplicate both black & white and color tapes quickly, economically and faithfully, in mass production quantities. With our 2" VTP, one hour of tape may be duplicated in 9 minutes. The possibilities resulting from this development are infinite.

We invite you to see it. Along with Panasonic ADVISION Display System. Slide Processor and Microfilm Processor Cameras. High Speed Printing Tubes. And more. All part of our "New Concepts in Visual Communication."

PANASONIC®
just slightly ahead of our time.
200 PARK AVENUE, NEW YORK, N.Y. 10017

Electronics Components Department
Matsushita Electric Corporation of America
200 Park Avenue, New York, N.Y. 10017
(212) 973-5710

See "New Concepts in Visual Communication" at the IEEE Show, Booths 4J11 to 4J17, and 4J12 to 4J18.

Dynamic duo.

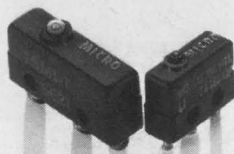

Dynamic variety in subminiature switches. Our SM and 1SX switches.

Take our SM series with a complete variety of integral or auxiliary actuators, bifurcated gold contacts for improved reliability and quick-connect

detent terminals. It's temperature resistant and meets Military Specification 8805.

And if our SM won't fit your needs, try our tiny 1SX. It's the smallest of the snap-action switches, and has low differential—.001 inch max. And it has all the features of the SM.

For more information on these dynamic subminiatures, contact your MICRO SWITCH Branch Office, Authorized Distributor or write for Catalog 50.

MICRO SWITCH

FREEPORT, ILLINOIS 61032
A DIVISION OF HONEYWELL

HONEYWELL INTERNATIONAL: Sales and service offices in all principal cities of the world.

Electronics Newsletter

March 2, 1970

Autonetics struggling on MOS contracts

Autonetics is having its troubles with three big metal oxide semiconductor contracts, and for three different reasons—slow shipments, low yields, and high prices.

Shortages of packages for large-scale integrated circuits, not MOS processing problems, are delaying shipments of devices to Japan's Sharp Corp. (formerly Hayakawa) for Sharp's desk calculators [*Electronics*, Feb. 2, p. 33]. In fact, says a source close to Autonetics, yields on the arrays are "sensational."

But the story is different on two other fronts: multiplexing circuits being supplied to Instrument Systems Corp. for the Boeing 747 passenger service system, and arrays slated for the Viatron Corp.'s System 21 consoles.

The MOS LSI circuits for Instrument Systems combine digital and analog functions and burn-in is required. The result has been low yields. Because Autonetics isn't meeting delivery schedules, the Long Island firm has turned to second sources, and Motorola is one of them. The size of the Motorola contract with Instrument Systems isn't known. One Motorola official suggests that company joy isn't unrestrained because the circuits are difficult to make, but Motorola isn't turning down any new MOS business.

As for the "dramatically rising prices" that Viatron spokesmen cite as the reason for turning to other sources for arrays for the System 21 [*Electronics*, Feb. 16, p. 33], they're reliably reported to have been \$50 to \$75 per array, rather than the \$20 or less Autonetics originally quoted to Viatron. One source familiar with the North American Rockwell division predicts that unless overhead is trimmed significantly and profit and loss accounting is streamlined, the Autonetics Products division will be out of business in three years.

Bell shows 3-mask IC technique

Bell Labs has added another simplified, economical bipolar IC fabrication technique to its repertory. The new technique is the simplest yet, requiring only three masking steps (for base diffusion, combined emitter and collector diffusion, and metalization) in contrast to six or seven for the usual bipolar IC process and five for MOS IC's.

The TRIM (for tri-mask) technique is expected to compete head-on with MOS technology in mass memory and shift register applications. TRIM IC performance will be similar to that of MOS IC's, with gate propagation delay of about 20 nanoseconds and access time of a few hundred nanoseconds. But TRIM proponents point out that it is potentially a cheaper process than MOS because it has fewer steps, that the oxide stability problem that has plagued MOS doesn't exist in bipolars, and that it has a well-designed threshold voltage of only 0.6 volts.

Field-programmable ROM from Radiation

Dielectric isolation, a technology that has stood Radiation Inc. in good stead in its military radiation-hardened IC's, now is being used by the company in two unusual IC's for the commercial-industrial market. One is a 512-bit field-programmable read-only memory; it's a bipolar circuit that the user programs himself by applying a pulse to open the metalization in a cell where a zero is desired.

Use of dielectric rather than a p-n junction to isolate the circuit ele-

Electronics Newsletter

ments makes it safe to use the high energies necessary to open up the metalization. The advantage of customer programing is that thousand-dollar metalization-mask charges are avoided, as is the six-to-eight-week lead time that most IC manufacturers need for ROM's. And because the field-programable ROM is bipolar, it's faster than the usual MOS ROM—access time is about 50 nsec. W. H. White, MOS engineering manager, estimates the price at 3 cents per bit in large quantities.

Radiation's other product is a complementary MOS random-access memory with 2,048-bit capacity. Here, dielectric isolation adds the advantage of higher speed (100-nanosecond access time) and greater packing density to the low-milliwatt power dissipation advantage of C/MOS.

8-million-bit buffer sought for space . . .

Anticipating the requirements of the late 1970's Grand Tour mission to the outer planets, the Jet Propulsion Laboratory has requested proposals for the development of a semiconductor buffer memory that would store an unprecedented eight million bits. The lab envisions a configuration composed of 243 blocks, with 34,000 bits in each block. Other requirements: the memory must weigh less than 40 pounds, dissipate 10 watts, occupy only 1,000 cubic inches.

. . . as Viatron waits for megaword RAM

Viatron's C/MOS random-access memory chips, being developed by the Solid State Scientific Corp., have as one goal a megaword capacity. Viatron is testing a 10,000-bit memory wafer, and hopes that about 25% of the wafer's storage cells will be usable; that is, it hopes to store about 2,500 bits on the giant chips.

If that yield is reached, Viatron will request 2-inch wafers capable of holding 65,536 bits—or, with a 25% cell yield, a 1,024-word memory at 16 bits per word. Viatron hopes to test a prototype by August, and may offer it as a high-speed auxiliary memory for its computer late in 1970.

The IC memory is claimed to be potentially only a third as costly as core at about 0.2 to 0.3 cents per bit, not including read-write electronics. If so, the IC would replace core in all Viatron's computers, perhaps by the spring of 1971.

Beyond this, the 1,024-word-by-16-bit wafer will become the building block for the megaword memory—capable of storing data in amounts now associated only with drums and disks, but with a faster—and repeatable—access time of 3 to 5 microseconds. This is 18 months to two years away, depending on solution of packaging problems and on market demand.

NASA signs RCA for ERTS vidicons

NASA has completed a \$10 million deal with RCA for July 11 delivery of two flight models of a return-beam vidicon system for use with the Earth Resources Technology Satellite (ERTS). NASA also denied that RCA was having problems with the system, and Theodore George, ERTS program manager, suggested the rumors that RCA was in trouble may have stemmed from the early January failure of a 2-inch return-beam vidicon tube. But, George said, the failure was not unexpected, adding that its replacement has been working well in feasibility tests.

George also disclosed that NASA has agreed on another \$10 million contract for the Hughes multispectral scanning system, and said "everything is proceeding well" on the program.

Op Amps go *High Voltage*

MC1536 sets a new pace for Operational Amplifiers with low input currents, internal compensation, plus high-voltage capability!

Here's the one that changes the whole ball game for monolithic Op Amp applications where a large output swing is required. The MC1536 doubles the maximum supply voltage now available to Op Amp users ... ± 40 Vdc ... while still preserving input differential voltage protection and output short-circuit protection. And, with all that, typical input bias current is just 8.0 nA and offset current is 1.0 nA. Just think how you can utilize your full supply voltage in a wide variety of control-system applications. Even in servo-amplifier work, you can have both higher voltage and lower current.

Here are some other applications made possible by the high-voltage breakthrough of the MC1536:

- High-Voltage Differential Amplifiers and High-Impedance Differential Buffers.

- **Voltage Regulation**

Op Amp regulators that used to "float," can now be driven directly. This results in better regulation (both load and line) and, of course, fewer parts.

- **Current Regulation**

With the MC1536, it's possible to have a 5 mA current source with .01% regulation, where $R_L = 0$ to 10 K.

- **Wide-Range Sample and Hold Circuits**

A pair of MC1536's will simplify these traditional discrete device designs and will give an input voltage range of ± 30 V. A 2.0 V/ μ s Slew Rate allows moderate chopping speeds and the internal compensation provides for a stable unity gain buffer without external components.

For information about the specifications that make possible this wide range of new applications for monolithic operational amplifiers, simply turn the page. ▶

- Output Voltage — 60 V P - P (min)
 - Max. Supply Voltage ± 40 V
- Input Bias Current — 8.0 nA (typ)
- Input Offset Current — 1.0 nA (typ)
 - Internally Compensated



- where the priceless ingredient is care!

MOTOROLA
Integrated Circuits

Check these pace-setting specs for the **MC1536G, MC1436G**, industry's first high-voltage monolithic Op Amp

- Maximum Supply Voltage – ± 40 Vdc
- Output Voltage Swing – (min)
 ± 30 V_{pk} ($V^+ = +36$ V, $V^- = -36$ V)
 ± 22 V_{pk} ($V^+ = +28$ V, $V^- = -28$ V)
- Input Bias Current – 20 nA max
- Input Offset Current – 3.0 nA max
- Fast Slew Rate – 2.0 V/ μ s typ
- Internally Compensated
- Offset Voltage Null Capability
- Input Over-Voltage Protection
- A_{VOL} – 500,000 typ
- Characteristics Independent of Power Supply Voltages –
 $(\pm 5.0$ Vdc to ± 36 Vdc)

TYPICAL NON-INVERTING X10 VOLTAGE AMPLIFIER

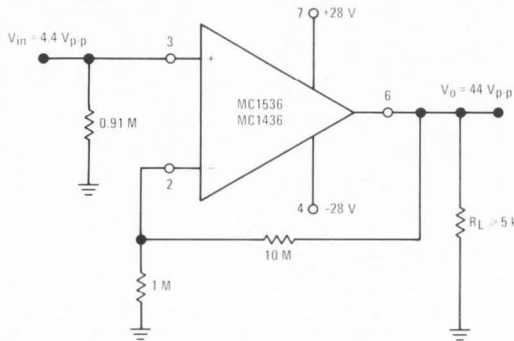

PEAK OUTPUT VOLTAGE SWING
versus POWER SUPPLY VOLTAGE

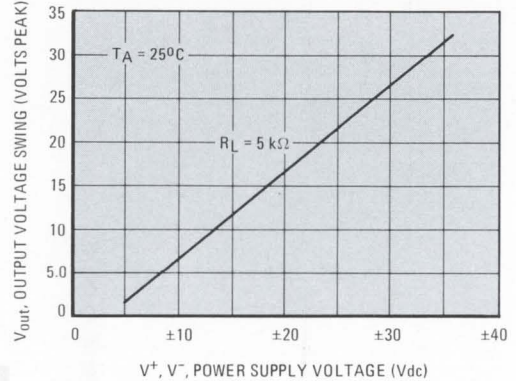

CIRCUIT SCHEMATIC

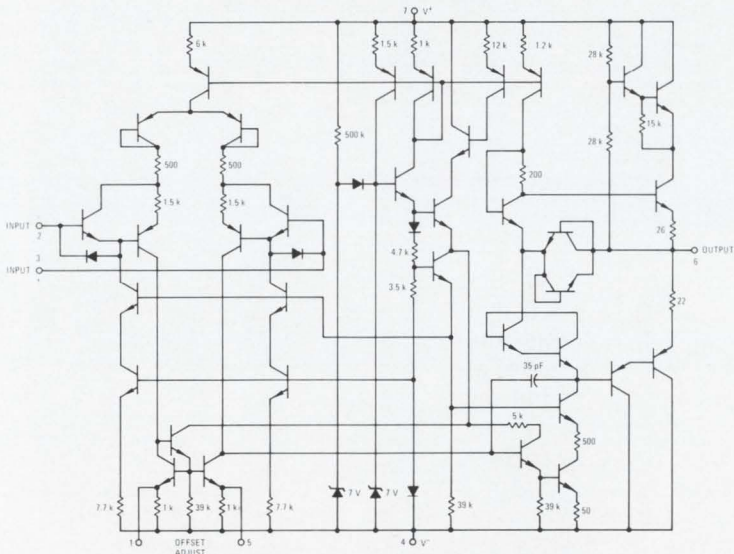

EQUIVALENT CIRCUIT

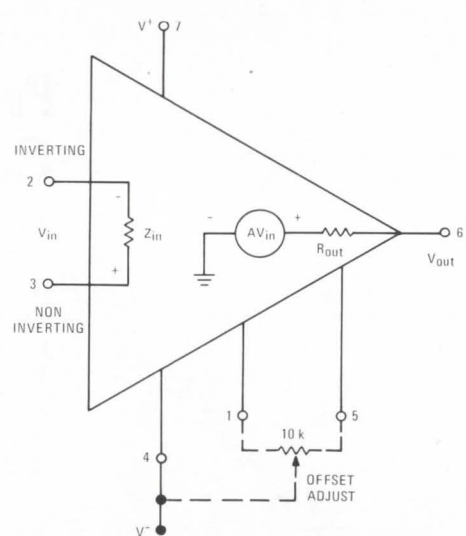

**Double your supply voltage
...double your Op Amp
applications range
with the MC1536**

The MC1536G and the low temperature-range MC1436G are available in the 8-pin (TO-5) package from distributor stock. The 100-up price for the MC1536G is \$39.00, and the MC1436G is \$18.00. For complete specifications and applications information, circle the reader service number on the opposing page, or write: P. O. Box 20912, Phoenix, Arizona 85036.

The circuitry shown external to Motorola products is for illustrative purposes only, and Motorola does not assume any responsibility for its use or warrant its performance or that it is free from patent infringement.



—where the priceless ingredient is care!

MOTOROLA
Integrated Circuits

Three **new** reasons to specify

D I G I E C



Model 262

Digital Multimeter

(AC, DC, Ohms)

A .1% Multimeter for everyday usage. A necessity for design and development, production, quality control, or anywhere that DC volts and current, AC volts, and ohms are measured. Battery pack available.

\$375



Model 311

Precision Calibrator

(Voltage & current source)

A .01% precision voltage and current Calibrator that serves as a working standard. In addition, the high current capability may be used as a lab source for developing those critical circuits so essential in electronics today.

\$650

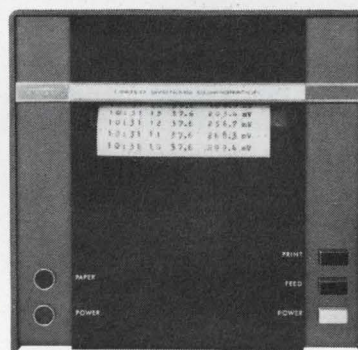

Model 691

21 Column Printer

(3 lines per second)

A Drum Printer which is expandable from 4 to 21 columns to satisfy your specific requirements. This versatile printer accepts all standard BCD inputs and provides 38 symbols along with "floating" decimal point.

starting at **\$770**

See us at booth
2E 44-46



D I G I  E C

by **UNITED SYSTEMS CORPORATION**

918 Woodley Road • Dayton, Ohio 45403 • (513) 254-6251
Representatives Throughout the world

For complete specifications
request new catalog D69A

← Circle 36 on reader service card

Circle 37 on reader service card

37

NEW TECHNIQUE IMPROVES LOW-LEVEL SIGNAL MEASUREMENTS

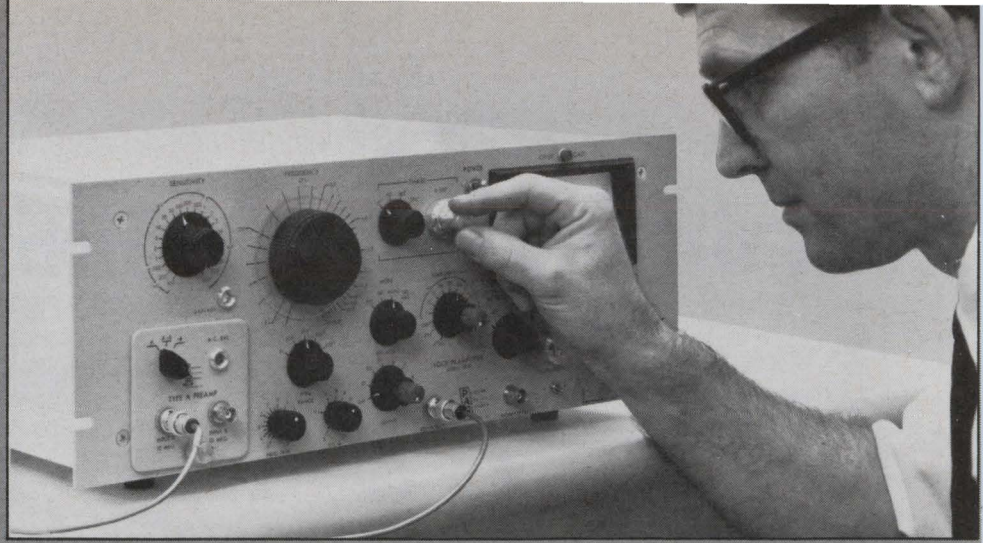

Where extremely low-level signals must be measured in the presence of obscuring noise, the use of a PARTM Lock-In Amplifier can often transform a complex and sometimes futile investigation into a routine test procedure. For example, Lock-In Amplifiers can be used to:

MEASURE AMPLIFIER CROSSTALK TO ONE NANOVOLT

Where amplifiers are in close proximity in low level data processing systems, the minimum detectable signal is frequently limited by the crosstalk or mutual interference generated. By using a Lock-In Amplifier to measure crosstalk: (1) The source of feed-through can often be identified since very low-level crosstalk can be measured over a wide frequency range. (2) Further extraneous signal coupling errors are eliminated because no instrumentation other than the Lock-In Amplifier is necessary. (3) Crosstalk levels as small as one nanovolt can be detected. (4) The phase of the crosstalk can be identified.

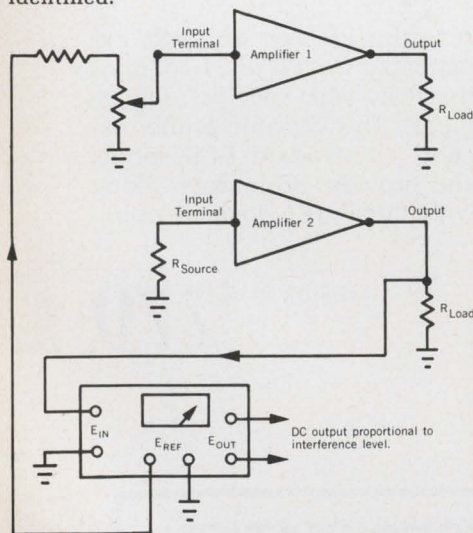

LOCK-IN AMPLIFIER
USED FOR AMPLIFIER CROSSTALK MEASUREMENT

IMPROVE BRIDGE SENSITIVITY TO ONE NANOVOLT (FS)

A Lock-In Amplifier improves bridge sensitivity without over-driving the bridge circuit. Excite the bridge with the Lock-In Amplifier's internal oscillator and connect the external null detector termination to the signal input to get: (1) Measurements over frequencies of 1.5 Hz to 150 kHz. (2) Optimum noise figures using available preamplifiers with input impedances of several ohms to 100 meg-ohms. (3) One nanovolt full-scale sensitivity for improved null accuracy and extremely low power dissipation in critical circuits. (4) A dc signal proportional to the off-null condition for use in modifying bridge parameters or as a recorder input. (5) Detection of in-phase (resistive) and quadrature (reactive) bridge components which can be nulled independently (and simultaneously, if desired).

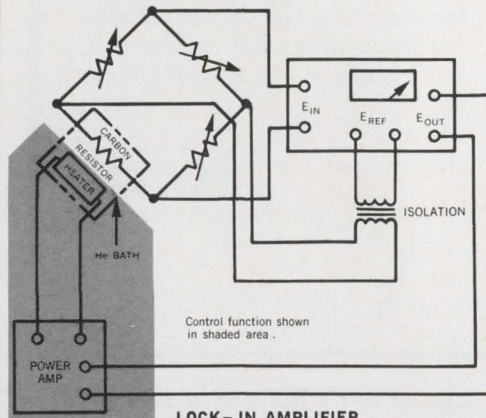

LOCK-IN AMPLIFIER
USED AS BRIDGE OSCILLATOR/NUL DETECTOR

MONITOR OP AMP SUMMING JUNCTION VOLTAGES TO 10 NANOVOLTS

The open-loop gain of op amps can be measured by monitoring the summing point voltage while operating the amplifier in its normal closed-loop configuration. The advantages of using a Lock-in Amplifier to make these measurements are: (1) Its self-contained oscillator serves as a signal source for the op amp over a wide frequency range. (2) Distortion and offset at the summing junction are minimized by the Lock-In Amplifier's high input impedance and low noise. (3) Summing junction voltages as low as 10 nanovolts can be measured and recorded to permit measurement of extremely high open-loop gains. (4) Phase shift can be measured.

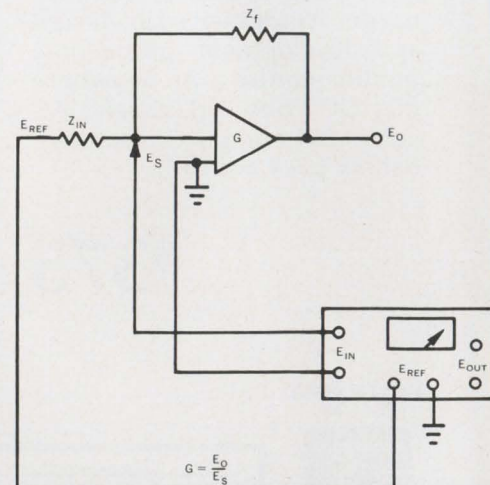

OP AMP OPEN-LOOP GAIN MEASUREMENTS
WITH LOCK-IN AMPLIFIER.

If you have a problem unearthing low-level signals buried in noise, why not call on a PAR applications specialist. He may be able to show you a better way to dig. Call him at (609) 924-6835, or write Princeton Applied Research Corporation, P.O. Box 565, Princeton, New Jersey 08540.

PAR

PRINCETON APPLIED RESEARCH CORPORATION

"Visit us at IEEE Booth 2K31"

Geostationary satellite to chart clouds

Thousand-pound SMS will maintain fixed position over northern half of U.S., keeping closer tabs on weather; NASA has asked \$15.6 million for project

Perhaps the ultimate in weather satellites, described by an aerospace executive as one that would "look out over the earth as God might," is heading for orbit. The latest weather-eye-in-the-sky is NASA's synchronous meteorological satellite or SMS, a geostationary craft that will watch motionless over the northern half of the U.S. from a 22,500-mile altitude.

Because it's stationary, unlike the orbiting Nimbus and Tiros satellites, the thousand-pound SMS will provide almost continuous pictures of global cloud-cover patterns. This will allow weathermen to keep much closer tabs on developing tornadoes and hurricanes, says Walter J. Garbacz, NASA's program manager. Bids for building the satellite are due to NASA by the end of March. In the fiscal 1971 budget, the agency has asked \$15.6 million for the project, a jump of almost \$13 million.

Readings. Nimbus and Tiros can send their pictures only to the ground terminals they happen to be passing over. At most, these stations receive a weather picture of their area only twice a day. In the near future, at least, SMS will complement, rather than replace, those satellites.

In addition to taking day and night cloud-cover pictures—with a spinscan radiometer that operates in the visible and near infrared—SMS will collect data from various types of earth-based sensors, such as river gages, automatic weather stations, and ocean buoys. The electronics system aboard the satellite will be able to interrogate thousands of these sensors. Data will be transmitted to earth over S-band links, requiring different ground terminals, from the vhf automatic pic-

ture transmission stations that receive Nimbus and Tiros signals.

The radiometer is being developed by Hughes Aircraft's Santa Barbara research center with funds separate from those for the satellite. Picture resolution will be a half-mile, compared with the two-mile resolution of the visible-spectrum radiometers Hughes developed for the advanced technology satellites. The same organization is also developing the earth-sensing multispectral scanner for the earth resources technology satellite (ERTS).

However, the status of the ERTS and SMS program are quite different, says Steven D. Dorfman, manager for space applications and exploration at the Hughes Space Systems division. "ERTS is a technology development program," he points out, "while the synchronous meteorological satellite will be part of an operational system."

Like forms. With the general decline in NASA space projects, quite a few companies may bid for the SMS, including those with minimal experience in building spin-stabilized, geostationary systems. "It may be the only way for some to remain in the space business," comments one industry executive. Most likely to bid are companies such as Hughes, which built the ATS satellites and which has, according to Dorfman, been studying SMS for "more than three years," and TRW systems. Builder of the Intelsat 3 satellites for Comsat, TRW says it is "considering" a bid. And so is Philco Western Development Lab, which developed synchronous satellites for the United Kingdom and the NATO nations.

A contract for the new satellite will probably be awarded in the last quarter of 1970, according to NASA's

Gerbacz. Launch of the first vehicle is slated for early 1972. The Environmental Science Services Administration will operate the satellite once it's orbiting and also give it a new name—the Geostationary Operational Environmental Satellite, or GOES.

Advanced technology

Mixed bag

In 10 years or so, if a research project at the University of Illinois bears fruit, you may be able to build a computer or other complex gadget out of a bag of mixed, un-packaged semiconductor chips without even taking them out of the bag. You'll just broadcast instruction into the bag from a low-powered transmitter on your lab bench; the last instruction will be "go," and the bag will compute.

The project, dubbed Project APE, for autonomous processing element, is being carried out by graduate students under the direction of W.J. Poppelbaum, an electrical engineering professor. It's not as far-fetched as it sounds. Even though the chips in the bag are scooped in at random, like jelly beans of various colors, they'll be able to interconnect themselves.

Each chip's design will include a tiny a-m transmitter to broadcast signals at a fixed frequency to all other chips in the bag, and an f-m receiver to take instructions at the same fixed frequency from the bench transmitter. These instructions tune the chip's inputs to receive a-m signals at other frequencies; after all the chips have been tuned, they have, in effect, been in-

U.S. Reports

terconnected to perform a computing function. Even the power supply can be connected by radiation if the chips have low-power circuits.

Bag it. To program the bag for a specific function, the user broadcasts a special code among the chips, while listening for a response from inside the bag. If he gets a response, he knows that the bag contains at least one chip made to operate at that frequency, so he tunes the chip to effectively connect it to other chips. He repeats this process for as many frequencies as he needs to implement a desired function.

In general, the bag will contain more than one chip for each given frequency. This improves reliability through redundancy—during the instruction process, when the user gets a response at a particular frequency, he doesn't care whether the response comes from one chip or from 100; he just tunes them all to the same input frequency.

Conceivably, the user might discover that his bag doesn't contain enough frequencies to execute the function he had in mind; but if his collection of chips is properly chosen, the probability of such an occurrence is very small. It's like buying five pounds of jelly beans at the candy store: chances are slight that they'll all be purple, or green, or yellow.

If the user needs 100 frequencies and buys 100 chips, the chances are very good that some of the chips are identical and therefore he'll run out of frequencies before he's finished programming—unless the number of available frequencies in the collection from which he buys is very much greater than 100. If it isn't, to be safe he should buy many more chips than he really needs; he doesn't have to bother with sorting them out.

Games people play. It's like throwing dice. Throw six dice, and the probability of getting a different number on each die is very small; but throw 60 dice all at once out of a bucket, or use six 20-sided icosahedral "dice," and the probability of getting six different numbers at least once is much better.

Poppelbaum's group currently is

building an experimental version of APE, using 12 modules of somewhat fewer than 12 different frequencies. It represents an advancement in the art of stochastic processing, a topic that Poppelbaum has been pursuing for some years [*Electronics*, Dec 12, 1966, p. 48]. Stochastic processing uses digital circuits to process analog signals whose magnitude is represented by the average value of a train of randomly spaced pulses of equal height. Therefore, a stochastic processor is essentially an analog processor with one important difference: it can produce any desired degree of accuracy at the cost of a sufficiently long computation time, whereas accuracy of a conventional analog processor is limited by the resolution of its operational amplifiers and by similar physical restrictions.

There's an almost disturbing resemblance between the mechanism of Project APE and a hypothetical mechanism that defines the way human brain cells develop. This resemblance hasn't escaped Poppelbaum; he's talking to neurophysiologists about it, but unfortunately neurophysiologists and electrical engineers don't speak each other's language very well.

Communications

Omega's millions

Omega, the shipboard and airborne navigation system that has cost the Navy more than \$30 million in R&D since the 1950's, is ready to make its second—and by far the largest—purchase of AN/SRN-12 shipboard receivers [*Electronics*, Nov. 10, 1969, p. 153]. Early in May, the Naval Electronic Systems Command (Navelex) will award a contract for up to 800; an estimate of the contract's value, based on a price of \$6,000 to \$8,000 for each of the 10-kilohertz receivers, is \$5 million to \$6.5 million.

The leading contender in the competition is the Northrop Corp.'s Nortronics division, which developed the Omega package and received the initial \$1.7-million pro-

duction award for 140 models. They cost approximately \$11,000 per set. However, with Omega technology well in hand and 10 companies expected to respond to the Navelex specification, SRN-12 unit prices are to come down sharply, say Navy sources. Expected to be competing strongly, however, are Pickard & Burns, which ran second to Northrop on the first purchase, as well as the Edo Corp., Tracor, and ITT, among others. Tracor and ITT have received small Navy contracts for shipboard receivers in the past. On the new award, the Navy expects to have bids in hand by the first of April.

In the air. Though shipboard receiver procurements are expected to climb as high as 1,300 Navy units over the next five years, suppliers see an even bigger dollar market for airborne systems beginning in 1971. Estimates of Navy requirements alone range from 500 to 1,000 units at an estimated \$40,000 for a full system. Flight tests on the land-based antisubmarine warfare P-3C Orion are continuing, with a modified Northrop system using only the front-end receiver and buffers with the plane's Sperry Univac computer. This is the type of system forecast for use in Lockheed's new S-3A carrier-based antisub aircraft, too, employing the on-board computer system. Such a package will cost far less than the \$40,000 full-scale airborne system, of course.

The Navy is still investigating a wide variety of airborne hybrid navigation systems coupling the Omega phase-locked, superheterodyne receiver with doppler, loran, inertial, optical, and satellite techniques. No single system selection has been made, however.

On the commercial side, Northrop's shipboard system—estimated to cost \$6,000 a copy sans the rugged military case, built-in oscilloscope, and recorders—has been sold for the British tanker Manchester Challenge and the Queen Elizabeth 2. Two other units have been bought for evaluation by the Coast Guard.

For foreign sales, Northrop is now negotiating with an unnamed Japanese manufacturer for distri-

March 2, 1970

Electronics Index of Activity

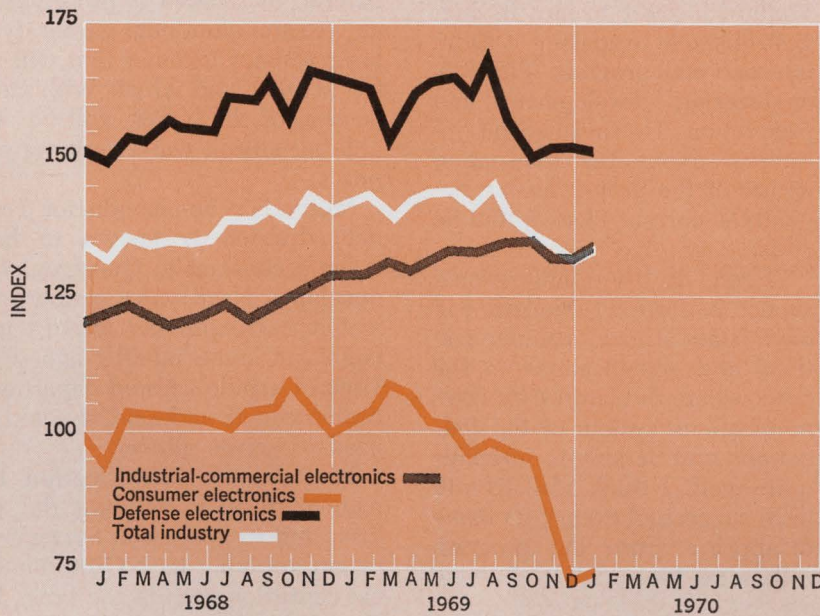

Segment of Industry	Jan. 1970	Dec. 1969*	Jan. 1969
Consumer electronics	74.9	73.7	102.1
Defense electronics	151.5	152.3	165.9
Industrial-commercial electronics	134.2	132.0	129.0
Total industry	134.2	132.2	144.2

Electronic production in January snapped its four-month decline and bucked the general trend of the economy as well by climbing 2 full index points to 134.2. However, the total still is 10 points shy of the year-ago figure of 144.2.

The consumer and industrial-commercial sectors paced the one-month gain. Consumer production rose 1.2 points to 74.9, while industrial-commercial registered a 2.2-point advance to 134.2. For the consumer sector, the advance was its first on a monthly basis since it picked up 1.3 points last August. Defense electronics, the month's only loser, dipped 0.8 point to 151.5.

Indexes chart pace of production volume for total industry and each segment. The base period, equal to 100, is the average of 1965 monthly output for each of the three parts of the industry. Index numbers are expressed as a percentage of the base period. Data is seasonally adjusted. *Revised.

bution and manufacturing rights comparable to its U.K. agreement with Marconi International Marine.

Is Mallard a phoenix?

Talk to the Army about its international tactical communications project called Mallard, and the program is described as alive and well, proceeding with the \$16 million left in its fiscal 1970 budget request of \$21 million.

The view is substantially different from Capitol Hill, however, where Rep. George Mahon's defense appropriations subcommittee strongly recommended late last year that Mallard be canceled, and the rest of the House concurred. "As far as we're concerned, that money was left in for termination costs," a committee official says, "and if the Army is using it for new contracts we'll have to look into that again."

The Pentagon's Directorate of Defense Research and Engineering is nearly finished with a reassessment of the four-nation project and will deliver its recommendation to Capitol Hill shortly. Military and industrial participants in Australia, Canada, and the United Kingdom are watching the U.S. leadership with interest.

Contracts. The Army is proceeding with contract negotiations nevertheless. The Joint Engineering Agency, overseeing the program at the Army Electronics Command, Ft. Monmouth, N. J., is known to be negotiating an award to Sylvania Electronic Systems for a Mallard switch, largest single component in the system. And another contractor, Booz-Allen Applied Research, is sufficiently confident of its \$1.6 million support contract for integration of three of Mallard's seven system operations that it has transferred more than a score of engineers to Ft. Monmouth on a permanent basis. The Vitro

Corp., another integrator, is proceeding with the same degree of confidence.

In the remaining 18 months of the two-year Mallard development effort, the Army and its contractors, foreign and domestic, plan to build and test models of virtually every segment of the system. A few will be simulated for test purposes. One industry source suggests project officials can accomplish most of this with existing fiscal 1970 funds, stretching them out with a bit of reprogramed money if no new funding is forthcoming. Another contractor official notes that "it would probably cost as much to terminate Mallard now as it would to finish this advanced development phase."

Progress on the digital communications system couldn't be going much better, say insiders. Phase I, or feasibility of the giant program, was completed in June 1969 after 150 international communicators had met at Ft. Monmouth in the

U.S. Reports

spring to go over the Phase 1 studies. It was agreed that Mallard was technically feasible.

The Army was particularly proud that it had completed Phase 1 at \$19.7 million, under the \$20 million ceiling, and that it had stayed on schedule.

New issue. Rare as it may be for a high-technology, military program to deliver successful performance on time and within its specified budget, this may no longer be an issue in the eyes of men with the money in Congress. "The Army isn't doing what they were told," says one Hill leader coldly. "And we intend to find out why." Beyond antagonizing a Congress already disturbed about escalating defense costs, the Army appears not to have factored in a major political issue—the need for an international military communications net like Mallard in a period when the Nixon Administration is reflecting the national desire to pull back from multination military commitments. One Congressional staff man summarizes it this way: "If the United States pulls back most of its troops from Europe—as Nixon seems sure to do sooner or later—who will we have to communicate with? Mallard will be superfluous."

Beyond this, there are strong indications that the Nixon Administration is rejecting the concept of any large-scale ground warfare in the future—the kind of warfare Mallard is designed for—in favor of an Eisenhower-Dulles posture that a major ground war would quickly escalate to the level of intercontinental nuclear exchange.

Phase 2—concept formulation—was next, and Mallard project managers budgeted between \$30 million and \$40 million, with the U.S. share 62% of that, to be spent in fiscal 1970 and 1971. Not much of this has been spent pending some kind of agreement with Congress. Only one American Phase 2 contract, for support, has been signed so far, while two have been awarded in Britain. But five to 10 contracts are ready to go if Congress gives the program its blessing. Some of the other nations in Mallard are understood to have already awarded Phase 2 contracts.

Big cloud ahead?

At least one insider feels that Mallard has yet to face its biggest obstacle to making it as an international program—Phase 3, engineering development and production. He says he isn't optimistic about the four-nation nature of the project lasting beyond the current Phase 2. But he adds:

"Even if the international aspect is dropped, Mallard will have standardized communications and specifications to the point where the late 1970's communications system of the four nations will be able to interface quite well. I think Mallard will have succeeded even if its name disappears from the program rolls after Phase 2."

And RADAS, the random access discrete address system being designed and developed separately by Martin Marietta in Orlando, Fla., was also recommended for the ax, it still is being considered as one of Mallard's subsystems. RADAS is a separate development program but Martin-Orlando completed a Mallard study to determine RADAS application to the multination project. The Mahon Committee has recommended killing RADAS because it was "still unproven" and would not interface with Mallard.

If the Army can get Congress to change its mind on Mallard within the next few weeks as it hopes to be able to, then it doesn't expect much slippage in the original timetable. Operational goal for Mallard is 1977.

Manufacturing

Clean cut

Despite a number of obstacles still to be overcome [*Electronics*, Oct. 13, 1969, p. 33], the interest in laser scribing of silicon wafers appears to be growing at a number of semiconductor manufacturing firms—

and more potential suppliers of the laser dicing equipment are surfacing. Later this month Hughes Aircraft will have a prototype of an yttrium-aluminum-garnet (yag) laser resistor trimmer that will sell for \$17,000, and which, with modification of the optics, will be suitable for silicon wafer scribing purposes.

Motorola's Semiconductor Products division is known to have given a contract to Quantronics to develop a laser wafer scribe, and Autonetics expressed interest in a yag laser some months ago when Union Carbide's Korad department introduced it and said it could be used to scribe silicon.

Hughes, with its Electron Dynamics division building the yag laser and its Industrial Systems division applying its NC200 numerical control system to the table, has already built one system exclusively for wafer scribing to the specifications of a major supplier of metal oxide semiconductors. But the unit hasn't been delivered because money tightened at the MOS house, and the \$35,000 machine had to be shelved. This tool uses a 10-inch-by-10-inch table, and holds four 1.5-inch-diameter wafers. A soluble protective coating on the wafers prevents splattering of molten silicon from damaging the integrated circuit or LSI dice. After scribing, the solvent is removed.

Splash and price. Splattering of molten silicon and high price are the chief hurdles to be mastered before laser scribing becomes a production tool in the semiconductor business. Regarding price, Howard Dicken, vice president and operations manager at Integrated Circuit Engineering, the Phoenix consulting firm, says that the first laser silicon scribes to be marketed will probably cost from \$20,000 to \$30,000, "and most semiconductor manufacturers will probably buy one at that price to evaluate it."

He says further that laser wafer scribes might sell well at \$20,000 if they offer the advantages most often mentioned for them, despite the fact that diamond scribes sell for as little as \$4,000. These include:

▶ Cutting a clean, square edge that

Why Intel uses Teradyne J259's to test memory devices

When we asked Intel's test supervisor, Les Vadasz, what he liked most about the Teradyne J259 computer-operated IC test system, he smiled and said: "It runs."

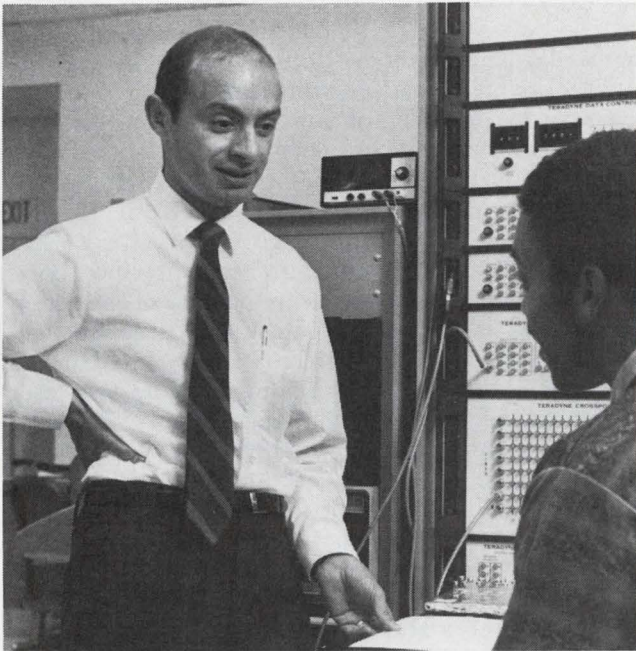

"Just running" is no small matter, as any IC producer can tell you. It's especially vital when you're testing 256-bit silicon-gate MOS memories like Intel's. When your devices are that exotic, you want the most unexotic test system you can find. One that doesn't go off the air once a week. One that doesn't need periodic calibration. One that "just runs."

How dependable are Intel's J259's? So dependable that Intel finds it hard to put a number on downtime, but estimates that less than *1 percent* of its test-facility downtime is attributable to the Teradyne systems.

And Intel's J259's work hard. They make as many as 10,000 functional and parametric tests on each 256-bit

MOS memory. They also test all of Intel's new Schottky-barrier bipolar memories. They test packages. They test wafers. They classify devices. They datalog test results. They generate test summary sheets and distribution tables. Since everything is done on a time-shared basis, it all adds up to an awesome test capability per J259, hour after dependable hour.

Intel's new lines of memory devices mark the company as a leader in its field. So does its choice of test equipment—equipment that, in the best Teradyne tradition, "just runs."

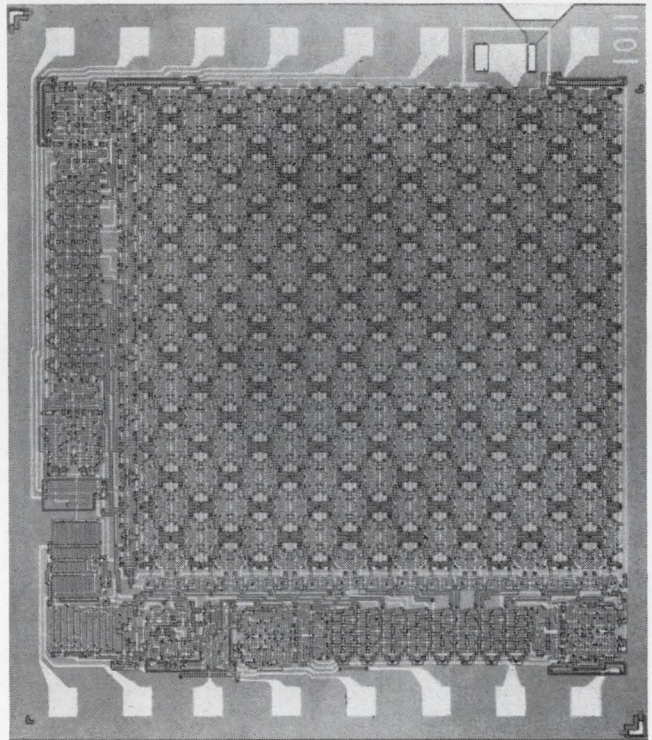

Teradyne's J259 makes sense to Intel. If you're in the business of testing circuits—integrated or otherwise—it makes sense to find out more about the J259. Just use the reader service card or write to Teradyne, 183 Essex St., Boston, Massachusetts 02111.

Teradyne makes sense.

LET GPS HELP YOU
THINK FUNCTIONS

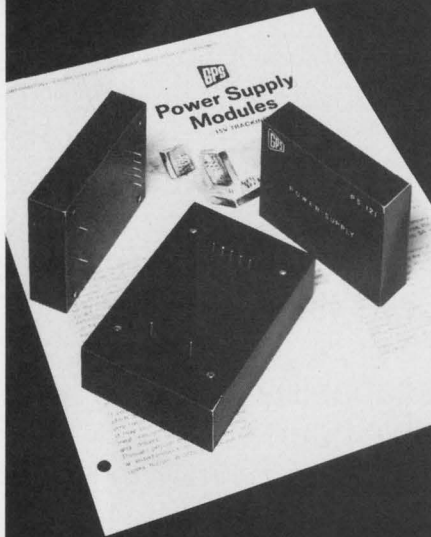

LOW PROFILE Power Supply Modules

±15V TRACKING

- Available from stock.
- Low prices: \$33 and up in quantity.
- 8 Models with output currents from 50 mA to 200 mA.
- Line regulation to 0.005%.
- Load regulation to 0.02%.
- Noise: 1 mV peak-to-peak max.
- Encapsulated in compact 0.78" thick x 2 1/2" x 3 1/4".

Write for descriptive brochure and application notes to:
GPS CORPORATION
14 Burr Street,
Framingham, Mass. 01701
(617) 875-0607



GPS — The Complete Source for
Compatible Operational Elements.

U.S. Reports

facilitates automatic chip handling;
▶ Providing a deeper cut than diamond scribes and to give a higher yield at the breaking operation;

▶ According to Dicken, a savings in silicon real estate.

Dicken notes that 7 mils is the usual line width for diamond scribes—including a 3-mil scribe line and a 4-mil safety factor. The laser scribe line is more typically 0.5 to 1 mil wide, and Dicken says just 1 mil saved on the die perimeter can offer major cost savings. He thinks it might be possible to pack devices close enough together to get a 5% increase in the number of dice per wafer.

As for silicon splattering, Dicken says: "The power and wavelength of the laser can control this." Dicken says he's seen several examples of dice taken from wafers that had been either scribed all the way through or only partially through and then broken apart, and reports that the dice looked "very good." He favors partially cutting through the wafer, however, because he feels it would be difficult to cut through a 10-mil thickness without problems as the semiconductor industry turns more and more to 2-inch wafers at that thickness. But if the cost of laser silicon scribing equipment got down to \$10,000, "it would probably take over the scribing market," Dicken observes.

What goes up. A. Robert Ruiz, laser sales administrator in the Hughes Electron Dynamics division, says the optics modification required to make the resistor trimmer—called Model 5561H—a silicon wafer scribe would involve changes to direct the laser beam up from the bottom of the equipment so that the cut is made on the wafer bottom, eliminating splattering onto the active device surface. This would be followed by a conventional breaking operation.

The machine, however, probably wouldn't incorporate the binocular microscope it now does as a resistor trimmer, nor would it necessarily include a Hughes-supplied table. Elimination of this hardware would lower the price.

The yag laser in the 5661H has an average power of 0.75 watt and

2,000 watts of peak power. The 1.06-micron wavelength allows a laser beam spot size of about 0.5-mil diameter, but the width of the scribe line depends on the quality of the optics used to focus the beam.

Ruiz says Hughes has been doing laser dicing for two semiconductor manufacturers in the San Francisco area for about six months, in addition to the MOS manufacturer for whom Hughes built the custom machine that has yet to be bought. For one of these firms, the laser cut too deep at first, and splattering was a big problem with a spot diameter of almost 1 mil. Hughes tried again with a 0.5-mil spot size and got better results, then tried scribing from the back of the wafer, but the cut wasn't deep enough. The effort continues, and Hughes is trying to improve the yag laser design to reduce its cost. The laser alone cost \$19,000 just a year ago, but the entire resistor trimmer will go on the market priced \$2,000 less than that, so Hughes is inching down toward the figure at which ICE's Dicken estimates laser wafer scribing could present a serious challenge to diamond scribing.

Dicken is quick to point out, though, that such diamond-scribing equipment suppliers as the Tempres Research Co. are working on improved techniques, and don't seem to be too concerned about being challenged soon by lasers. Another vote in favor of lasers, though, comes from Benson Austin, president of Affiliated Manufacturers Inc., a manufacturer of semiconductor chip handlers and feeders. He says, "Laser scribing holds tremendous promise in a field that has needed correction for several years."

Commercial electronics

Little push

A mirror smooth sheet of plastic less than one-eighth inch thick with printed numbers on it is likely to be a mockup of a keyboard, right? Not this time; the three-month-old Flex-Key Corp. of Waltham, Mass.,

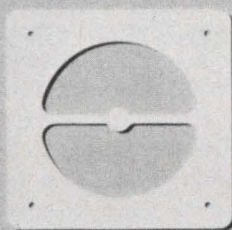

an apology from
Al Si Base[®]
CERAMIC
SUBSTRATES

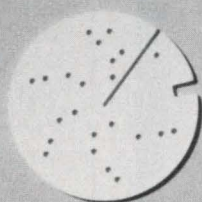

We extend sincere apologies to our good customers where we could not fill your full substrate requirements in 1969.

1969 saw AlSiBase[®] substrate production at an all time high. We had foreseen a healthy increase in your demands, but you went far beyond our highest estimates.

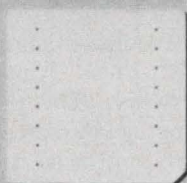

What to do? Should we relax our standards, use partly trained personnel, and make promises based on hope instead of reason?

We chose to do it the American Lava way. Quality was maintained, and expansions were started that are now coming on stream.

Our R&D engineers pioneered ceramic substrates almost twenty years ago. They developed the present standards of the industry, AlSiMag[®] 614 for thick film and AlSiMag[®] 772 for thin film, and continue their leadership with new items almost ready to be announced.

We, therefore, are very optimistic about the 70's and thank you for your business and patience with us during the trying year of 1969.

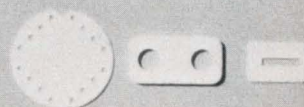

Now is a great time to talk with us about your new substrate requirements.

CODE IDENT. NO. 70371

American Lava Corporation **3M**
 A SUBSIDIARY OF **COMPANY**

PHONE 803/682-3215 • LAURENS, SOUTH CAROLINA 29360, U.S.A.

PHONE 615/265-3411 • CHATTANOOGA, TENNESSEE 37405, U.S.A.

For service, contact American Lava representatives in Offices of Minnesota Mining and Manufacturing Company in these cities (see your local telephone directory): Boston: Needham Heights, Mass. • Chagrin Falls, Ohio • Chicago: Elmhurst, Illinois • Dallas, Tex. • Indianapolis, Ind. • Laurens, S. C. • Los Angeles, Calif. • Metropolitan New York: Ridgefield, N. J. • Up-State New York and Canada: Phoenix, N. Y. • Orange, Conn. • Philadelphia, Penn. • St. Louis: Lee's Summit, Mo. • South San Francisco, Calif. • Tempe, Ariz. • International: c/o American Lava Corporation, Chattanooga, Tenn. 37405, U.S.A., TELEX 558432

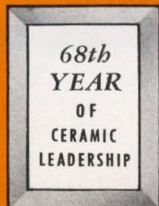

L.E.D. INDICATORS

New! Solid State—Infinite Life!



Actual Size

TEC takes the latest technology and gives it practical application. We've built an easy-mounting line of subminiature indicators and switch-indicators, using the new L.E.D. (light emitting diodes).

They're tough. The red-emitting L.E.D. light source gives infinite life and reliability, resistance to shock and vibration, avoids catastrophic failure.

There are two-terminal models operating from a 5 VDC supply and transistor controlled models—which interface directly with RTL, DTL and TTL microcircuit logic—operating from signal levels of: ON: +2.5 to +10 VDC, OFF: 0 to +0.8 VDC.

All models rear-mount in a 1/4" hole on 3/8" centers. They feature fast switching capability, three lens color choices (transparent red, transparent amber and clear) and the easy installation you expect from all TEC-LITE indicators. As low as \$3.55 in 100-499 quantities.

For full information on the SS Series—or our complete line of display/control products and systems—write: TEC, Incorporated, 6700 So. Washington Avenue, Eden Prairie, Minnesota 55343.

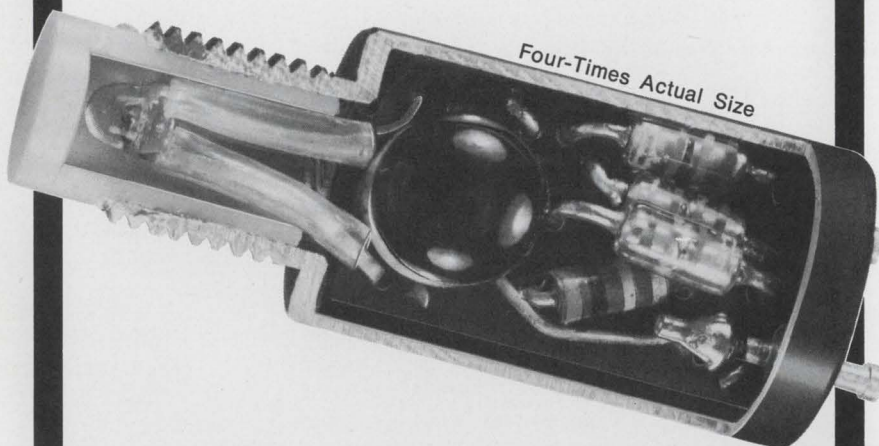

TEC[®]

INCORPORATED

U.S. Reports

has developed a keyboard without apparent failure mechanisms, with good potential for very low cost mass production, and a very thin structure—from an eighth to a quarter of an inch thick. And it looks like a fat plastic card—compared to present designs, most of which use (or have evolved from) reed switches and are 2 to 3 inches thick, the Flex-Key design is vanishingly small.

Designed by the company's president, William B. Sudduth, the keyboard is an integrated design. Instead of building up an array of individual key switches to form the size of board desired, Sudduth's keyboards can be turned out as a unit in a vacuum forming press.

Thus it takes no more work to make one single key than to make a typewriter-sized keyboard, and with a labor-cost advantage like this, Sudduth says he eventually will sell encoding keyboards to computer input-output terminal makers for as little as \$30 to \$50 in quantity.

The keyboard is a sealed laminate. On the bottom is an epoxy printed-circuit board, and laid down upon it at the position of each key are interdigital conductive paths: shorting across any two of these "fingers" turns on the switch. The p-c board is masked, using silk-screen techniques so that it supports a flexible conductive plastic layer. Atop the conductive plastic is an elastic sheet used to give a springier feel to the keyboard. And covering all is a smooth white sheet of Mylar with the "keys" printed on it. This is the eighth-inch-thick version—thinner than many p-c boards alone.

The quarter-inch version eliminates the smooth Mylar top layer and the springy plastic underneath it and combines their roles in a rubbery layer with raised and embossed keys. So in this version, there are only three major layers.

From here. Right now, Flex-Key is making arrangements with a large keyboard maker to sell 10- to 12-key units into the numerical input field—adding machines and such. The company is concentrating on this market first, rather than the seductive computer terminal



weighs 7 lbs . . .

. . . the
SONY®/TEKTRONIX®
 portable oscilloscope

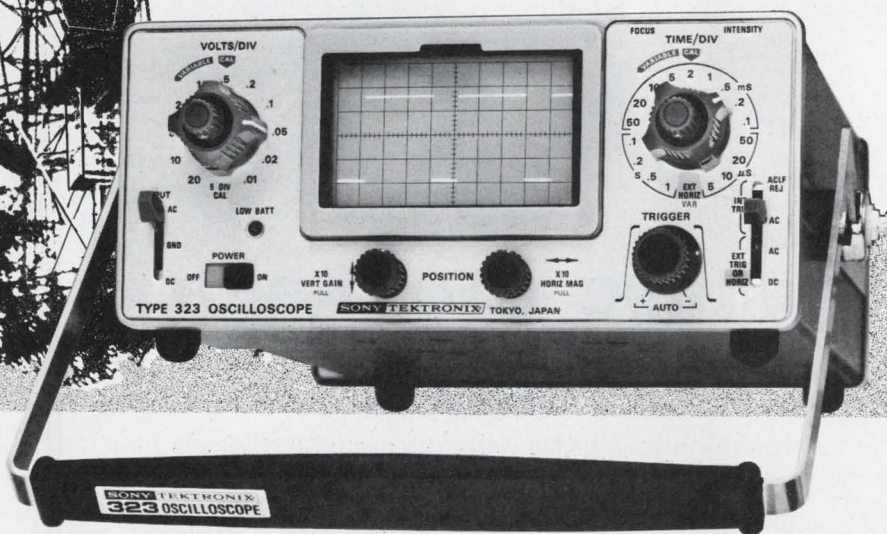

The **SONY/TEKTRONIX Type 323** Portable Oscilloscope weighs 7 lbs, is 4 1/4 inches high, 8 1/2 inches wide and 10 5/8 inches deep. It operates from self-contained batteries for up to 7 hours. With this compact, lightweight instrument, a user may move from one remote application to another without concern for power connections.

The Type 323 is especially well suited for maintenance of remote microwave installations, mobile communications equipment, aircraft and marine instrumentation, production control equipment, etc.

Batteries are rechargeable overnight (16 hours) by simply plugging the instrument into an AC outlet. The built-in charger will provide a fresh power source for use the next day. The Type 323 may also be powered from DC, 6 V to 16 V, up to 4.5 watts, and 90 to 136 VAC or 180 to 272 VAC, 48 to 440 Hz, up to 14 watts.

This solid-state portable oscilloscope also provides performance!

Bandwidth is 4 MHz at 10 mV/div deflection factor. For low signal level applications, 1 mV/div at 2.75 MHz is provided. Sweep rates are 1 s/div to 5 μ s/div, extending to 0.5 μ s/div with the X10 magnifier. A single control knob permits automatic or manual level sweep triggering, positive or negative slope. With no input the automatic trigger mode provides a bright baseline reference at all sweep rates. A 6 X 10 (1/4-inch div) internal non-illuminated graticule permits parallax-free measurements.

The Type 323 is designed for severe environments. Performance specifications are maintained within an operating temperature range of -15° C to $+55^{\circ}$ C. It also passes shock, vibration and humidity tests which simulate environments "portable" instruments are likely to encounter.

Your Tektronix Field Engineer will demonstrate the performance of the Type 323 in your application at your convenience. Please call him or write: Tektronix, Inc., P.O. Box 500, Beaverton, Oregon 97005.

Type 323 Portable Oscilloscope (including batteries) \$960
 U.S. Sales Price FOB Beaverton, Oregon



Tektronix, Inc.

committed to progress in waveform measurement

THE New GENERATION SCR

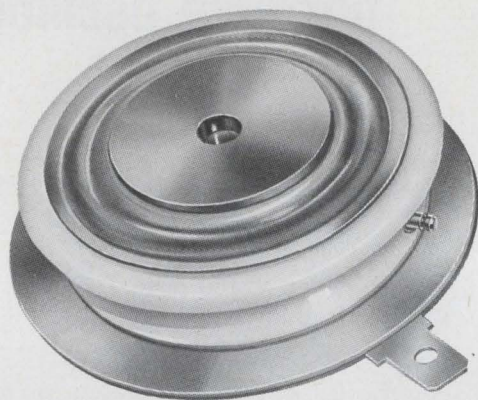

DISC PACKAGED REGENERATIVE GATE SCR's

Operation to 20 KHz with low switching losses
⊕ di/dt capability to 800 A/μsec. ⊕ low power gate drive ⊕ dv/dt capability to 500 V/μsec.
⊕ 175 and 370 amperes RMS ⊕ turn-off time capability to 10 μsec. ⊕ also available in stud type package to 470 amperes RMS.

For additional information and application assistance, write or call National Electronics, Inc., a varian subsidiary, Geneva, Ill. 60134, phone (312) 232-4300.

NATIONAL ELECTRONICS, INC.

a varian subsidiary

1969 COMPETITION WINNER
Cited by Industrial Research Inc.
as one of the 100 most
significant technical products of the year.



A NATIONAL® exclusive,
Patent Pending.

field, because it is here that it hopes to find quantity production and cash flow.

But an independent phone maker, impressed with the keyboard's seeming ability to "live forever," has ordered samples for button phones. Also, at least two computer terminal makers are looking at the keyboard, and a calculator maker has ordered samples.

But terminals still are attractive. The more buttons on a keyboard, the greater is Flex-Key's labor-cost advantage over standard keyboard formats. Thus, Sudduth speculates that his firm could produce a keyboard for a maximum of 50 cents a key in competition with reed devices that would cost 60 to 70 cents per key for the least reliable versions. Encoding would be an extra-cost feature in both cases. But Sudduth is thinking about encoding keyboards selling for \$30 to \$50.

If the user needed the version with raised buttons, the price would be about one-fourth higher than the flat-topped Mylar version of the keyboard.

Dexterity. But Flex-Key's basic design may have enough flexibility to be able to work in the custom computer terminal market. It's possible that one basic printed circuit could be made to satisfy all user needs and only the p-c board's masking and the Mylar-printed top layer would have to be changed.

Sudduth feels that when the right opportunity arises, he could get into production quickly because of the keyboard's simple construction. He estimates only two weeks total elapsed time to begin quantity production of flat-topped keyboards, and perhaps a month to gear up and produce units with keys you can feel.

Contracts

Small—and vanishing

Military contracting policies that allegedly discriminate against the small businessman in favor of the few large defense contractors are causing a growing concern on Capitol Hill. "Small business is gradually being squeezed out of defense contracting," says Richard

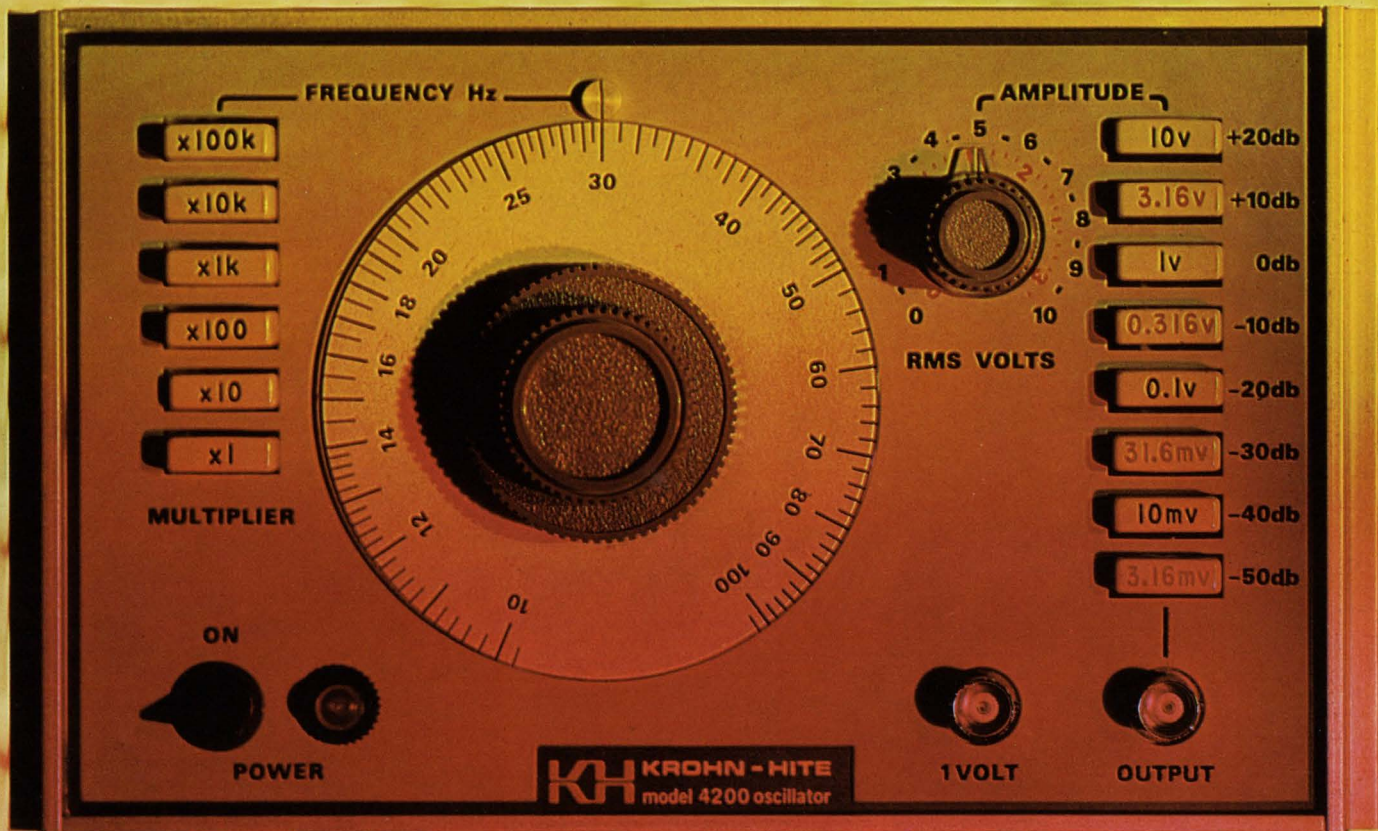

THE WAVEMAKERS

in every sense of the word

and we'll prove it!

We're challenging you to use our amazing new Model 4200 Test Oscillator in your own lab, on your own projects for 10 days without obligation. We're sure you'll be quick to recognize its superior performance, ease of operation, reliable accuracy, and unmatched value. The consistent half watt power output over the 10 Hz to 10 MHz range plus an internal impedance of 50 ohms means you can drive loads without overloading. Add excellent frequency response of 0.025 db and a distortion factor of 0.1% and you've got a versatile, high performance test oscillator that can't be beat.

Yes, Krohn-Hite, innovators in oscillator design for over twenty years, is making waves again!



First Class
Permit No.
30358
Boston, Mass.

Business Reply Mail

Krohn-Hite Corporation
580 Massachusetts Avenue,
Cambridge, Massachusetts 02139

KROHN-HITE MODEL 4200, 10 Hz TO 10MHz, TEST OSCILLATOR

- Frequency Range: 10 Hz to 10 MHz
- Power Output: ½ watt
- Maximum Output: 10 volts rms
- Frequency Response: 0.025 db
- Harmonic Distortion: 0.1%
- Frequency Accuracy: 2%
- Internal Impedance: 50 ohms
- Auxiliary Output
- External Synchronization
- Amplitude Stability: 0.02%



A low priced, solid state laboratory or production signal source featuring unusual flatness and ease of operation normally found in instruments selling a twice the price. The high power output signal of the Model 4200 delivers full voltage to the load over the entire frequency range. An infinite resolution dial and push-button multiplier provide rapid and continuous frequency tuning. In short, the Model 4200 is a broad range, versatile test oscillator destined to set new standards in performance and value.

KROHN-HITE MODEL 4100A, 0.01 Hz TO 1 MHz PUSH-BUTTON OSCILLATOR

- Frequency Range: 0.01 Hz to 1 MHz
- Power Output: ½ watt
- Harmonic Distortion: 0.02%
- Frequency Accuracy: 0.5%
- Amplitude Stability: 0.002%
- Frequency Response: ±0.05 db
- Internal Impedance: 50 ohms
- Square Wave Rise-time: 20 ns
- External Synchronization

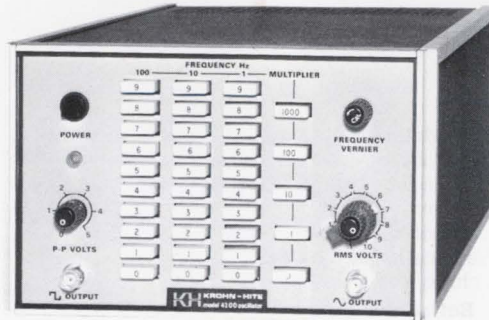

A medium priced, solid state, general purpose Oscillator that produces sine and square waves simultaneously from 0.01 Hz to 1 MHz with ½ watt of power into 50 ohms. Frequency calibration is within ±0.5% and push-button tuning permits ±0.1% frequency repeatability. 50 ohm internal impedance minimizes output voltage drop due to loading, specifically at higher frequencies where unavoidable capacitive loading limits the usefulness of higher impedance oscillators. The Model 4100A is an ideal laboratory and production instrument for a variety of applications where outstanding performance offers increased measurement speed and accuracy.

Yes, Krohn-Hite, the leader in variable filters, is fast becoming a leader in oscillators. Krohn-Hite has designed and manufactured a complete line of signal generating equipment to meet and, in many cases, exceed your project requirements. Each offers high performance features that you'd normally expect to cost a great deal more. Here's a brief rundown of the soon-to-be famous, never-to-be forgotten Krohn-Hite line. For further information on any of the instruments or complete details on our challenging Free Trial offer, simply fill in the attached postpaid reply card. We guarantee an answer by return mail.

OSCILLATORS

Frequency Range	Osc. Model*	Freq. Acc. %	Power (mw)	Impedance (ohms)	VRMS (Open Circuit)	Quad. Output	Add'l. Wave-Forms	Freq. Resp. (db)	Dist. %	Approx. Ship. Wt. lbs/kgs	Price
0.001 Hz to 100 kHz	4024	0.5	125	200/600	10	Yes	∩ ∩	0.01	0.01	24/11	\$1200
0.001 Hz to 100 kHz	4025	0.1	125	200/600	10	Yes	∩ ∩	0.01	0.01	24/11	\$1950
0.01 Hz to 1 MHz	4100A	0.5	500	50	10		∩	0.05	0.02	21/10	\$ 550
0.1 Hz to 100 kHz	4000	0.5	125	200/600	10	Yes	∩	0.01	0.01	18/9	\$ 850
0.1 Hz to 100 kHz	4001	0.1	125	200/600	10	Yes	∩	0.01	0.01	18/9	\$1450
10 Hz to 10 MHz	4200	2	500	50	10		~ (FIXED)	0.025	0.1	21/10	\$ 350

*Add suffix "R" for rack mounting.

PROGRAMMABLE OSCILLATORS

Frequency Range	Osc. Model	Freq. Acc. %	Max. Volts	Output Impedance	Dist.	Square Wave	Prog. Amp.	Approx. Ship. Wt. lbs/kgs	Price
0.1 Hz to 100 kHz	4030R	0.5	10 RMS	200/600	0.01%	optional	optional	27/13	\$1495
0.1 Hz to 100 kHz	4031R	0.1	10 RMS	200/600	0.01%	optional	optional	27/13	\$2145
0.1 Hz to 1 MHz	4131R	0.1	10 RMS	50	0.02%	yes	no	30/15	\$1375
0.1 Hz to 1 MHz	4141R	0.1	10 RMS	50	0.02%	yes	yes	30/15	\$1585
1 Hz to 1 MHz	4130R	0.5	10 RMS	50	0.02%	yes	no	27/13	\$1075
1 Hz to 1 MHz	4140R	0.5	10 RMS	50	0.02%	yes	yes	27/13	\$1285

- Yes, I accept your challenge to try the fabulous Model 4200 Test Oscillator. Send me complete details at once.
- Send me complete specifications on Model(s): _____
- Send me a copy of the complete K-H Catalog.
- Wow! You've aroused my interest and I can't wait. Please have your representative call me for an appointment.

NAME _____ TITLE _____
 COMPANY _____
 DIVISION _____ PHONE _____
 STREET _____
 CITY _____ STATE _____ ZIP _____

Here's your chance to put Krohn-Hite, the Wave-makers, to work for you. Accept our challenge and you'll never settle for less. Just fill in the attached post-paid card and we'll see that you get all the details on the Krohn-Hite Free Trial Offer by return mail. Then, you too can be a wavemaker.



KROHN-HITE CORPORATION

580 Massachusetts Ave., Cambridge, Mass. 02139
 Telephone: 617/491-3211 TWX: 710-320-6583

OVERSEAS SALES OFFICES: BELGIUM, C. N. Rood s. a. DENMARK, SC Metric A/S; FRANCE, Antares; GERMANY, Nuclotron Vertriebs-GMBH; HOLLAND, C. N. Rood n. v.; ITALY, Dott. Ing. Mario Vianello; SWEDEN, Teleinstrument; ISRAEL, R. D. T. Elect. Eng. Ltd.; JAPAN, Shoshin Shoji Kaisha, Ltd.; AUSTRALIA, Sample Electronics (Vic.) Pty., Ltd.; G. B., B & K Inst. Ltd. Printed in U.S.A.

U.S. Reports

F. Kaufman, economist on the Congressional Joint Economic Committee.

An underlying theme of hearings on defense spending has been the lack of competition in military procurement, which Kaufman says tends toward an oligopoly in the defense contracting industry. The committee's subcommittee on economy in government, led by Sen. William Proxmire (D., Wis.) plans to hold two series of hearings in late spring to early summer—one on national economic priorities and the other on defense economics. Though no topic has been definitely selected for the sessions on economics, the problems of small business due to the tendency of the military to favor large contractors must be considered priorities.

C.O.D. One of the biggest problems facing small businessmen, says Kaufman, is that for the duration of a contract they receive no progress payments from the Defense Department. Large companies get progress payments as a matter of doing business with the Pentagon. For the smaller company, however, payment is received when the job is completed, delivered, and accepted—which in many cases may be years from the start of contract work. Therefore, the small businessman must put up his own capital, usually borrowed. Interest rates are not reimbursed by the Government, and in many cases eat up any profit.

Another handicap for the small businessman, says Kaufman, is the Pentagon's "discriminatory allocation" of Government-furnished production equipment and facilities. Small companies usually do not get the use of Government-owned equipment, though this is probably due to the fact that small businesses usually are not contracted for major defense jobs—another area of concern.

Despite the Defense Department's "excuse" that it's difficult to get a small company to bid on a major weapons system, says Kaufman, the committee's feeling is that the Pentagon should break out subsystems for free competition among more small firms. The committee has found "evidence of a systematic

The Breadboard Is Obsolete Now There's A New Design Technique That's Faster, Easier And More Economical!

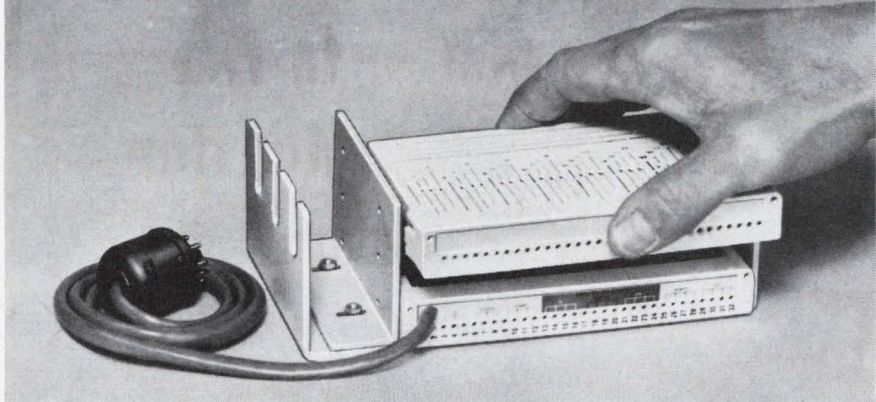

The New Heath "Stack-n-Patch"

Old Methods Can't Solve New Problems. Critical specs, higher density circuits, costly devices, tight schedules... these are today's design problems. Conventional breadboarding can't solve them. A more efficient method is needed. That method is here... the Heath EU-53A "Stack-n-Patch"... a totally new technique for circuit design and teaching.

A Better Way. The "Stack-n-Patch" eliminates soldering... just insert hookup wire or component leads into the special connectors. Because there's no soldering, there's no waste... no need to dike out components and throw them away. Expensive FET's can't be damaged from heat... limited quantity samples can be reused. The problems of the multi-layered rat's nest of breadboarding are also eliminated... the 177 patch connectors on the Component Patch Card are laid out according to common circuit board practice and closely simulate the circuit density and "stray" interaction of today's printed circuits.

Your Design—Stack It... Patch It. Included in the "Stack-n-Patch" are the Desk-Top Chassis, the Power Patch Card for bringing power from your choice of supply and the Component Patch Card. Designing is fast and simple. Pick your supply and connect it to the Power Patch Card... stack the Component & Power Patch Cards in the chassis... patch power to the Component Card and you're ready to go.

Pick A Card... Any Card. For IC work and other types of design that can't be built conveniently on the Component Card, Heath offers a wide variety of factory assembled cards to stack in the Chassis... Dual & Quad J-K Flip Flops, And-Or-Invert, Nand Gate, Dual Monostable, Op Amp... even a Dual Inline IC socket card and a blank circuit card ready to etch. Pick the one that meets your needs... stack it... patch it.

There Is A Better Way To Design. Order your Heath "Stack-n-Patch" now... and discover it!

Assembled EU-53A, 6 lbs. \$37.50

What You Get



Desk-Top Chassis



Power Patch Card



Component Patch Card

Pick Your Power Supply



EU-801-11 delivers 5 V @ 2 A max; 170 V @ 40 mA max; Plus and Minus 15 V @ 150 mA max. \$75.00, 8 lbs.



EU-41A delivers 0-15 V @ 0-750 mA. \$50.00, 6 lbs.



FREE Heath Scientific Instrumentation Catalog



copy now... just write on your school or company letterhead.

Describes these and other precision instruments for laboratory, engineering, education and R & D applications. Send for your FREE

HEATH COMPANY, Dept. 580-04
Benton Harbor, Michigan 49022

Please send FREE Heath Scientific Instrumentation Catalog

Name _____

Address _____

City _____ State _____ Zip _____

Prices and specifications subject to change without notice.
*Mail Order Prices; F.O.B. Factory

EK-279

Look what moved out of the lab and onto the production line...

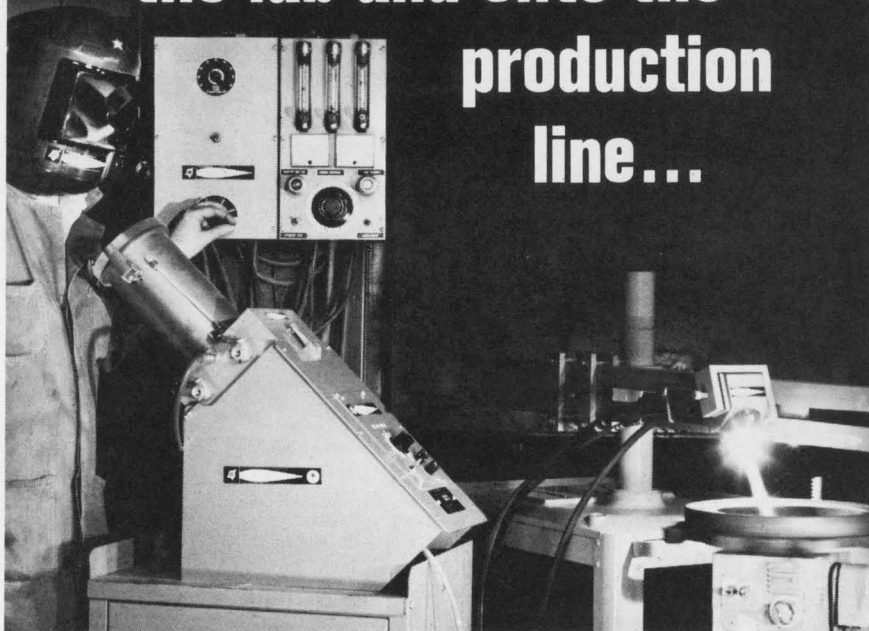

New for I.C. Fabrication

See the February 2 Issue of Electronics magazine

PLASMA SPRAY Systems put metallic, ceramic, plastic coatings on products to give them wear, temperature, or corrosion-resistant properties they never had before... and give the engineer design flexibility that can cut costs—improve performance.

Exciting capabilities, but it took a while to put that performance potential in production systems. Now it's here.

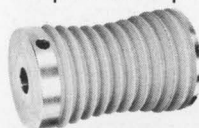

Plasmatron Spray Systems are used in the production of jet engines, water pumps, printing presses, electronic instruments, and a number of other products. Both automatic and manual systems are available... more than 150 materials can be applied.

Choose the best, most economical material for your product, and then add the required surface characteristics with a Plasmatron sprayed coating. The result is an easily controlled, dense, perfectly bonded coating that can be machined if desired. **Product costs go down, performance improves and life expectancy goes up.**



GET THIS BROCHURE on Plasmatron Spray Systems and Plasmalloy® Spray Powders. Find out how they can improve your product performance and fit into your production lines. Circle the number below, or write to: Manager, Plasmatron Sales, Dept. 101, Plasmadyne, a division of Geotel, Inc., 3839 South Main Street, Santa Ana, California 92702. For immediate action, phone: 714/545-7171.

plasmadyne

A GEOTEL COMPANY

3839 South Main Street, Santa Ana, California 92702



U.S. Reports

policy" not to let contracts on a subsystem basis, says Kaufman, going instead for the noncompetitive, negotiated, sole-source procurement method. "Much of the sole-source procurement is an unnecessary failure to break out subsystems for competition," he says.

Exodus. Such policies impose an enormous burden on the small contractors, says Kaufman. "They can't survive in the defense industry and they're leaving. This will be catastrophic for the industry as a whole, he says, because the tendency toward a defense industry oligopoly is spurred. And when an oligopoly exists in any industry, it will eventually be subject to regulation by the Federal Government.

For the record

Philco shuffle. Surprising no one—after Robert Hunter quit as president—Philco-Ford has realigned its many divisions into two groups. One, Aerospace and Defense Systems Operations, will be based on the west Coast and will be headed by John Lawson. The other, Commercial and Industrial Products Operations, will be based in and around Philadelphia under Howard Steller. The Steller group will include microelectronics, automotive electronics, and consumer products.

For sale. The latest symptom of woes at North American Rockwell's Autonetics division is the fact that it's trying to sell its unfinished \$23 million facility at Laguna Miguel, Calif. The site was to have housed the computer-making operation. Autonetics will have laid off 2,000 by March 6, and another 2,000 layoffs are due.

Specs. Those field effect transistors to be made by Siliconix as the company's first microwave semiconductor products [*Electronics*, Feb. 16, p. 33] will, typically, have a noise figure of 3 decibels at 1 gigahertz. The line of snap varactors to be used as multipliers will include a group specified at 10 to 12 watts at 2 Ghz, and another at 1 watt at X band.



Is minimum space
your goal...
or limited space
your problem?
**HERE'S THE
PANEL-MOUNTED
FUSEHOLDER
YOU NEED**
for 1/4 x 1-1/4 inch fuses

The BUSS HTA fuseholder measures only 1-25/32 inches in overall length and extends behind the face of the panel only one inch.

The holder features the popular bayonet type knob. A strong coil spring inside the knob assures good contact when the fuse is inserted into the holder. If a test hole in the knob is needed, a breakaway hole can be punched out to allow use of a test probe.

Rugged in construction to withstand vibration and shock, the HTA fuseholder can also be furnished with a special washer to make it drip-proof from the front of the panel. And the best feature of the HTA fuseholder is that it has *famous built-in BUSS quality*. You can't get it anywhere else.

For more information on the HTA fuseholder, or anything else in the

complete line of BUSS small dimension fuses, fuseblocks, and fuseholders, write for BUSS Bulletin SFB.

**Bussmann Mfg. Division
McGraw-Edison Co.
University at Jefferson
St. Louis, Mo. 63107**

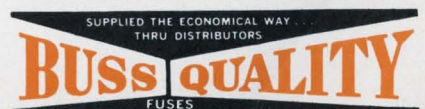

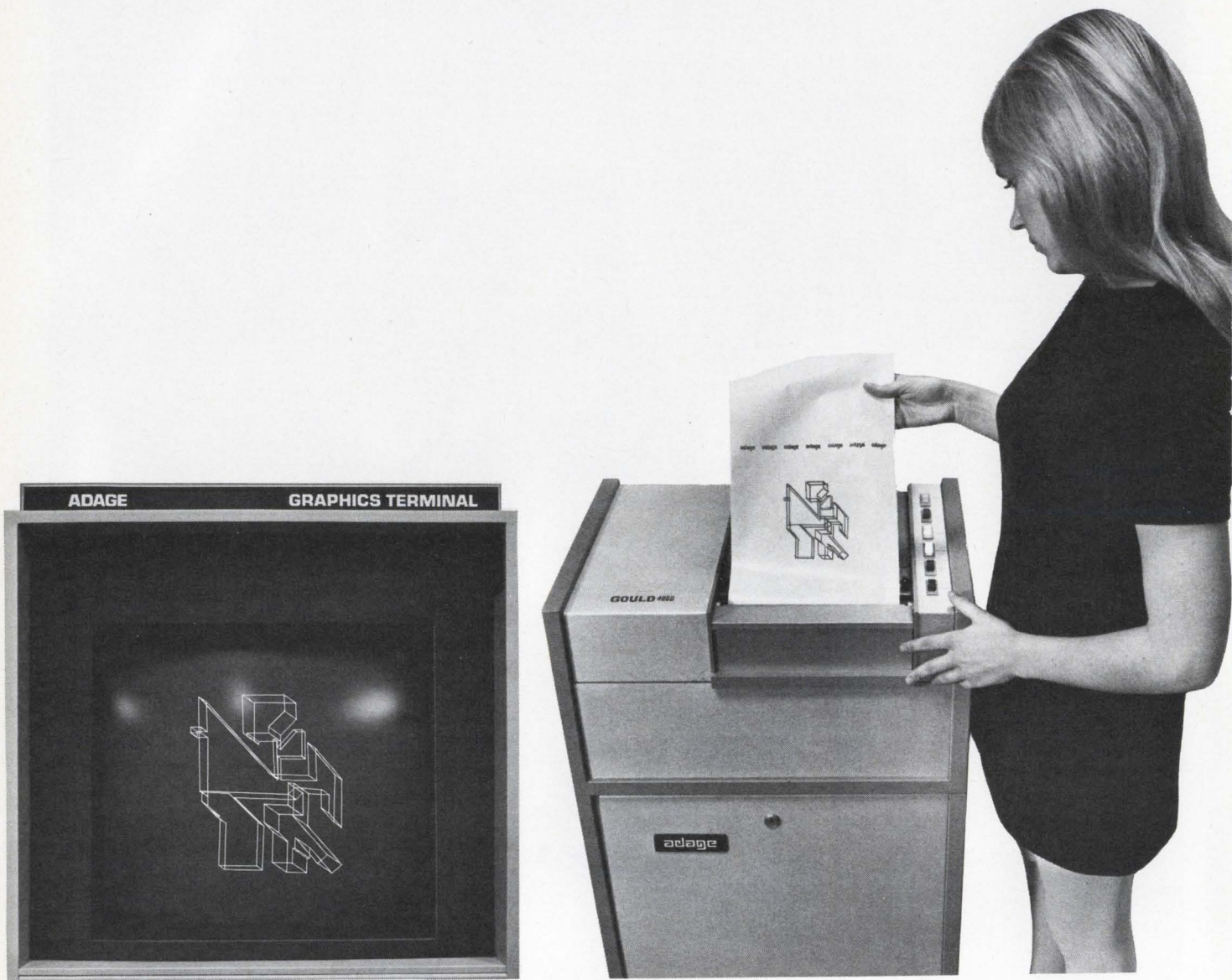

**From CRT display
to hardcopy printout.
In seconds!**

A plotter takes 30 minutes. A dry-silver photographic process makes muddy copies.

But at Adage, Inc. the Gould 4800 Electrostatic Printer puts out clean hard copy in seconds. No wait.

No wonder the 4800 is now a catalogued item for Adage Inc.'s award-winning Graphics Terminal.

The Graphics Terminal is a CRT display computer system with infinite potential for interactive graphics applications in science and engineering. To name a few, cockpit design, mathematical equations and printed circuit cards.

Having the 4800 Electrostatic Printer on line the user can alter his design equation with a light pen and have clean hard copy of any stage within seconds.

Adage officials say their system is further enhanced by the economy of the 4800. It doubles as a printer by putting out both alphanumerics and graphics. It has fewer moving parts to maintain than conventional equipment. And Adage interfaced the

4800 in a matter of days . . . at surprisingly low cost.

More 4800 facts:

At 412,000 characters per minute, the Gould 4800 breaks the old printout bottleneck on your computer. It reproduces signals from any source of digital input or data transmission by telemetry, radio microwave and/or land line, quickly, quietly, accurately and economically.

4800 can probably recap the same benefits for your system as it does for Adage's Graphics Terminal. Write us to see. Don't wait. Graphics Division, Gould Inc., 3631 Perkins Avenue, Cleveland, Ohio 44114.

GOULD CLEVITE

Gould 4800. The next generation of high-speed printers.

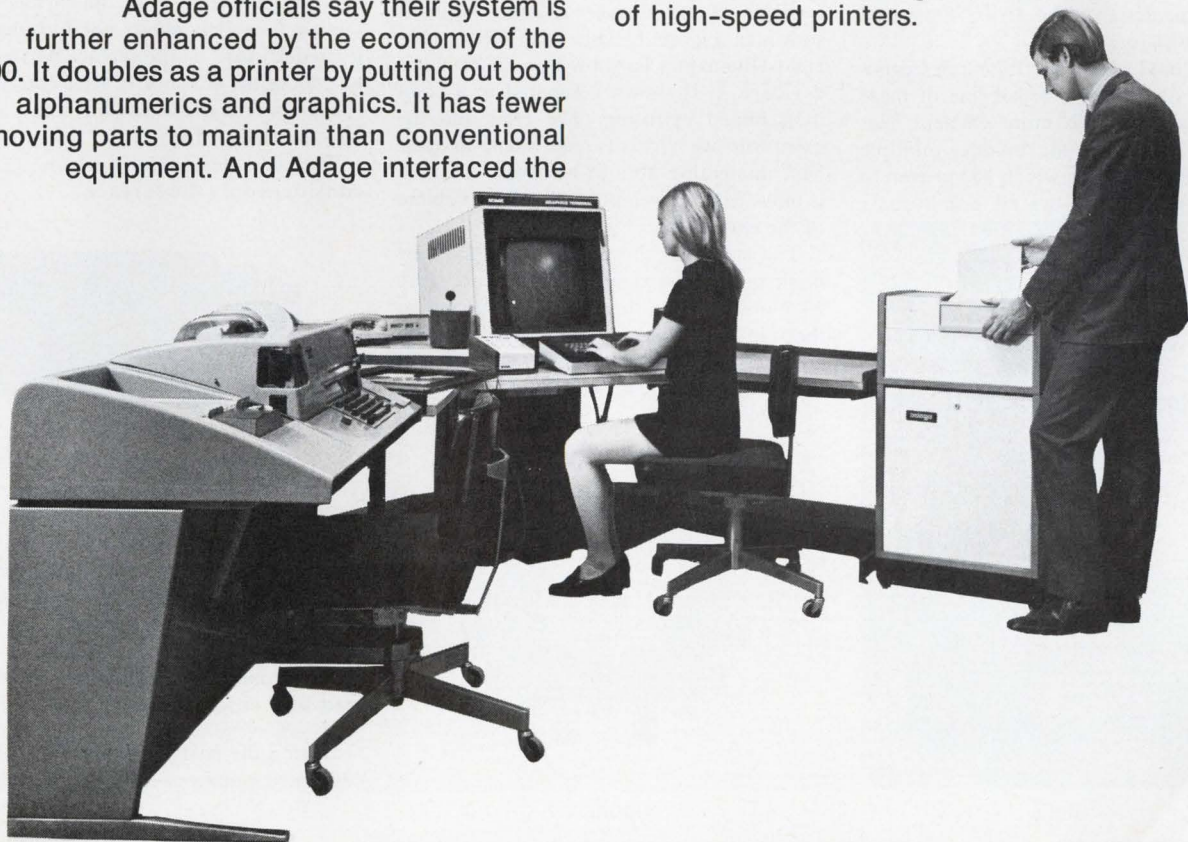

Staggered-finger heat sink design is more efficient, saves space and weight

Unique design is causing circuit designers to re-think their thermal theory.

Design engineers are learning daily that power ratings of power transistors are often not at all what they appear to be at first glance. For example, the data sheet on a transistor may state, "maximum power dissipation — 50 watts." But the fine print — if there is any — says, "at 25°C case temperature." Actually, the transistor alone will dissipate only 3 to 4 watts before the maximum allowable junction temperature is reached!

Obviously, something must be done to maintain the specified case temperature when more than 3-4 watts are to be dissipated. This is normally accomplished by mounting the transistor case to a dissipator or heat sink, but dissipator state-of-the-art has been such that these devices are too bulky, too heavy — just plain inefficient. Now you needn't tolerate these size and weight penalties in your design because IERC has achieved a major breakthrough in heat sink design: The IERC Staggered Finger Dissipator.

International Electronic Research Corporation has developed a broad line of these smaller, lighter, much more efficient heat dissipators based on the unique, multiple staggered finger design which has proven to be 30% more efficient overall, and in some

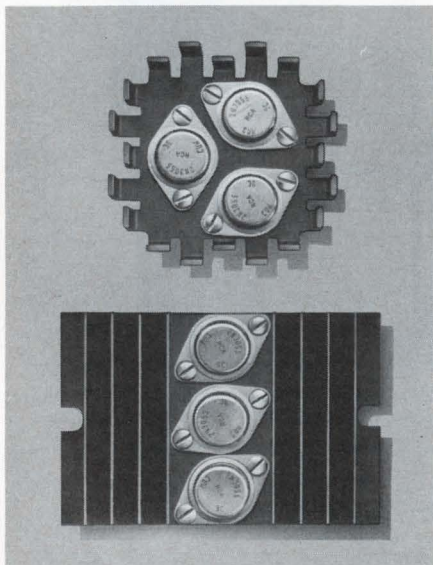

FIGURE 1

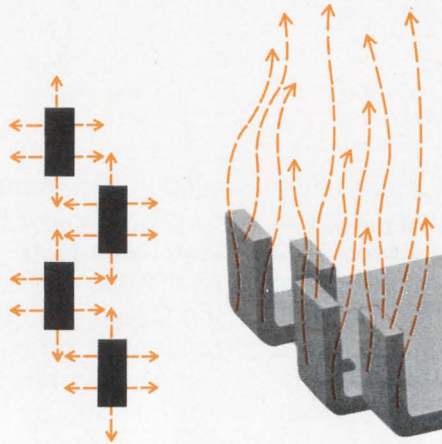

FIGURE 2

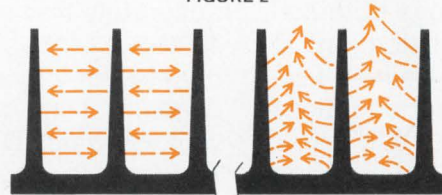

FIGURE 3

cases up to 500% more effective than many conventional designs now in wide use. An example of the staggered finger design is shown in Figure 1. This is an IERC HP3 Heat Dissipator. To show how efficient this device is, it is shown compared to a common finned extrusion. The HP3 and the extrusion are virtually equivalent in their heat dissipating ability; however, the HP3 is only 1/3rd the weight and 2/3rd the volume of the extrusion.

The secret to the efficiency of the new dissipators is the staggered fingers. (Figure 2) Note how the fingers are positioned so they do not radiate to each other and the configuration is so arranged that natural convection takes place very readily.

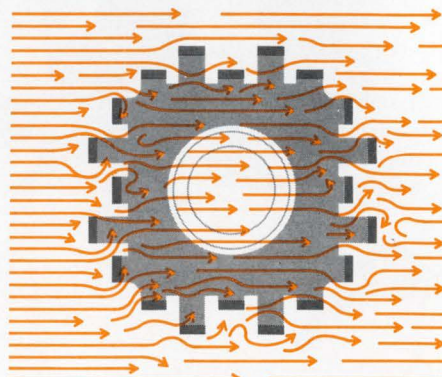

FIGURE 4

In a finned extrusion the fins radiate to each other and it is difficult for natural convection to take place in the confined area between the fins. (Figure 3)

In a forced air environment the staggered finger configuration is even more effective. The air can be from any direction. (Figure 4) As it hits the fingers, turbulence causes it to move around each of the fingers, striking many surfaces in its flow past the part. The turbulent air against these surfaces disturbs their surface barrier and is the principal reason for the significant improvement in the forced air heat dissipating properties of these parts.

Compare this turbulent air flow over the staggered fingers of the IERC part with the air flow conditions when directed at a finned extrusion. Here laminar air flow, rather than turbulent air flow, takes place. The air must be directed in one direction only, (Figure 5) parallel to the fins. The air enters the space between the fins; but because of this restricted space, it immediately tries to leave. Shortly after entering, it is not flowing against the bottom of the fin surfaces. Since the air flow is laminar, not turbulent, and it is not disturbing the surface barrier at the bottom of the fins shortly after entering, the surface areas of the fins are only partially effective.

The old rule-of-thumb which considers only the surface

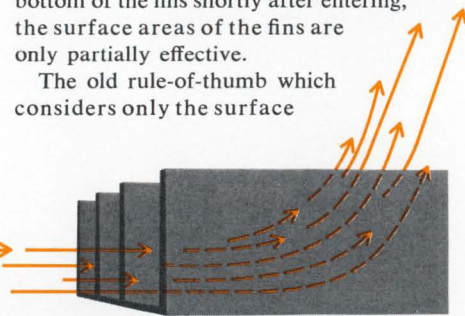

FIGURE 5

area relative to heat dissipation is not valid. The effectiveness of the area must also be considered. The staggered finger concept is a significant breakthrough in heat dissipating devices and is the first improvement in heat dissipator design since the flat fin or extrusion design.

Broad line accommodates all lead and case mounted semiconductors.

During the past several years, IERC has developed numerous heat dissipating devices

"See us at the IEEE Show Booths 4F19 and 4F20"

using the staggered finger configuration.

The UP style (Figure 6) is just 1.78 inches square and is available in various heights up to one inch. It was designed particularly to accommodate a single power transistor such as a TO36, TO3, TO15, etc. However, it will also accommodate more than one smaller semiconductor, including the newer plastic case power transistors.

To really appreciate the efficiency of the UP, refer to the temperature vs. power

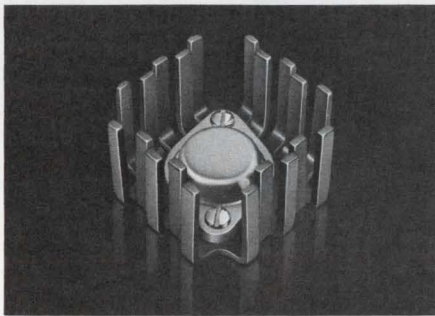

FIGURE 6

curve (Figure 7) showing a 2N1208 power transistor mounted in a UP-TO15-B dissipator. Remember, now, that this UP part weighs *less than one ounce*. Considering a maximum case rise of 100°C, the 2N1208 by itself will dissipate only 3 watts. When mounted in the UP dissipator in natural convection, it will dissipate 14 watts, or

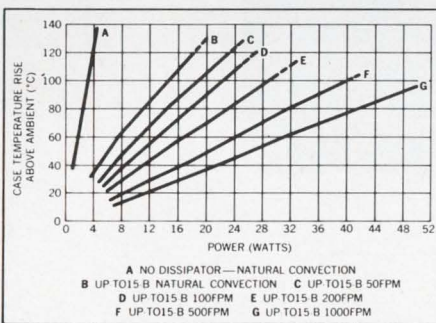

FIGURE 7

more than four times more power at the same case temperature. In a forced air environment of only 200 FPM, 28 watts can be dissipated — more than nine times the power at the same case temperature. With 1000 FPM, the remarkable light weight UP will allow 50 watts of dissipation from the transistor — *seventeen times more power at the same case temperature*.

Think now. You must limit the case temperature rise of a power transistor to 100°C. You need to dissipate 14, 28 or 50 watts. You have three cubic inches of space and are limited to adding one ounce of weight. And you can't spend more than 40 cents for a dissipator or sink in medium quantities. What would your present thinking lead you to do?

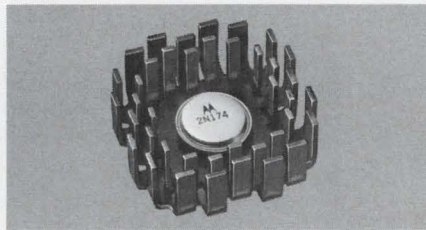

FIGURE 8

Another IERC dissipator, the HP1, is a companion to the HP3 shown in Figure 1. The HP1 is 2½ inches square, slightly larger than the UP. At the same case temperature rise of 100°C, it will dissipate 23 watts in natural convection; in a forced air flow of 200 FPM, it will dissipate 33 watts; and 65 watts with 1000 FPM. The HP3, which is 3⅞ inches square, will dissipate 28 watts in natural convection, 42 watts with 200 FPM, and 74 watts with 1000 FPM. When the HP1 and HP3 are nested, Figure 8, more than 100 watts can be dissipated at the same 100°C case temperature rise with 1000 FPM.

Stop and contemplate the sizes of heat dissipating devices which would have been required to dissipate these powers before the advent of the staggered finger design, and you will appreciate the savings of space and weight which the UP and HP make possible.

The staggered finger design has also been used in heat dissipators for TO5 and TO18 metal case transistors. Models in the LP Series, Figure 9, are available in three lengths and two heights and to accommodate one or two transistors. These parts are so efficient that when a TO5 transistor is mounted in the largest model

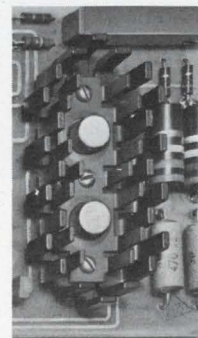

FIGURE 9

LP dissipator (only 2.31 x 1.12 x ½), the dissipator is virtually an infinite heat sink. The case temperature rises only 65°C when 5 watts are being dissipated. When 1000 FPM of air is used at 5 watts dissipation, the case temperature rise is phenomenally low — less than 15°C.

In addition to their thermal efficiency, LP parts are extremely versatile. Almost any application problem where a conduction plane is not available can be solved with these simple, low cost devices.

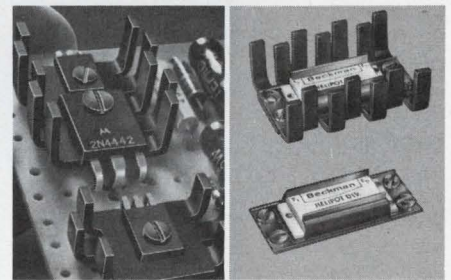

FIGURE 10

The staggered finger concept is also available in dissipators for plastic case power transistors and integrated circuits and microcircuit packages as shown in Figure 10.

The staggered finger concept of heat dissipation is the most significant breakthrough in heat sink technology since the advent of the power transistor. Get specific technical and pricing information on those IERC heat dissipators most applicable to your needs. Write on your company letterhead for Technical Bulletin 149 for more detailed information on the PA and PB series and Technical Bulletin 151 for the LB series. Technical Bulletin 134 and Test Report 172A detail the UP series; Technical Bulletin 139 and Test Report 198 cover the HP series; and for the LP series, ask for Technical Bulletin 135 and Test Report 182. You'll be surprised how substantially these advanced new heat sinks will contribute to the efficiency of your design and your equipment.

International Electronic Research Corporation, a corporate division of Dynamics Corporation of America, 135 West Magnolia Boulevard, Burbank, California 91502.



HEAT SINKS/DISSIPATORS

Q.A., Hi Rel and R&D require the range and accuracy.



Production goes for our stamina.

The new 5000C is the fastest, most complete and most versatile IC test system known to man. With a higher degree of accuracy over the full range in critical, exotic parameters, it has the kind of sensitivity which lights up the inner recesses of Q.A., Hi Rel and R&D. But it took the tough minded, plain pipe racks approach to get us on the production floor. Small space, no down-time, endless repeatability. And the tightest tolerances an IC has ever been probed for.

The 5000C handles DC, function, dynamic tests on digital and linear devices with up to 100 pins each on as many as five multiplexed stations at a time. It has higher throughput and tighter accuracies than any IC tester built or announced to date. Bar none.

Because it's computer controlled, changing tests or test sequences is as easy as changing programs. No re-wiring. No deadly delays. The 5000C comes complete with a library of fully documented programs for most major applications—as well as the best service and applications back-up in the world. More than half a million dollars in test systems are installed in our applications lab to assist you in special testing.

Call, write or TWX today. Our sales and service engineers throughout the world are waiting to serve you. Prices are right, and we're shipping from stock.



Division of Fairchild Camera & Instrument Corporation, 974 E. Arques Ave., Sunnyvale, California 94086 (408) 735-5011 TWX: 910-339-9217

You're no better

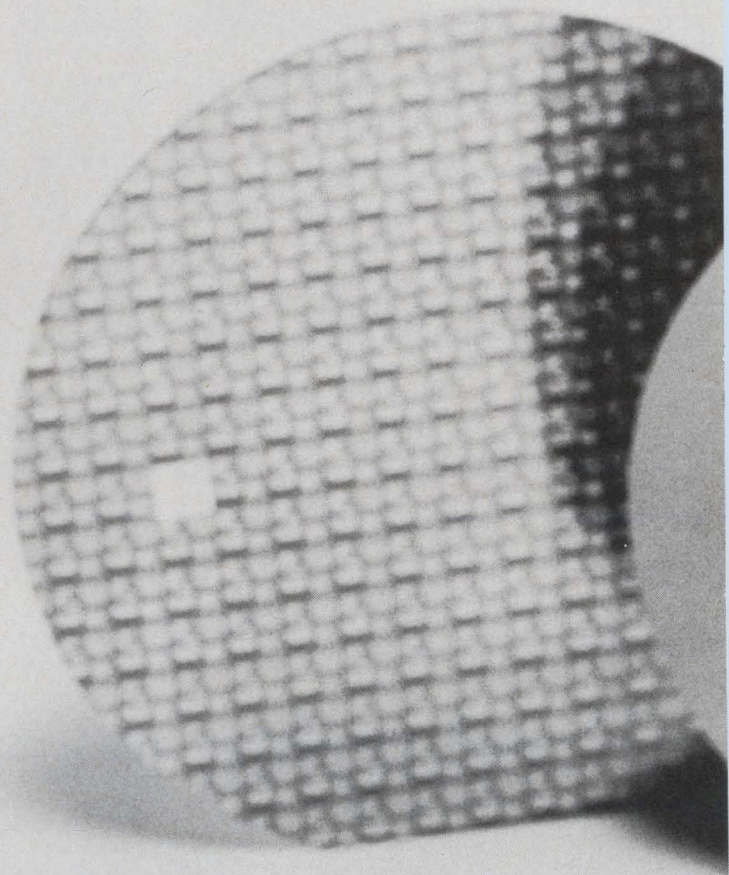

I.E.E.E., Booth 1F06-8

When the chips are down, no semiconductor device is better than the process equipment used to make it. If it isn't in the wafer, it isn't going to be. And that's where we can give you better control, tighter tolerances, endless repeatability and unsurpassed thin film uniformity and quality.

We manufacture the best epitaxial reactors and vapor phase deposition equipment in the industry. Bar none. Laboratory models that give you state-of-the-art processing to match your creative capabilities. Production

models that transfer state-of-the-art achievements into large volume production quantities.

With Applied Materials, you get true uniformity of film characteristics not only across the wafer and from wafer-to-wafer within a run, but most important—the same degree of uniformity in run after run after run. Thickness, resistivity, dielectric characteristics and surface quality are often uniform beyond current capabilities in delta measurement techniques.

Applied Materials' specifications weren't developed

than your wafers.

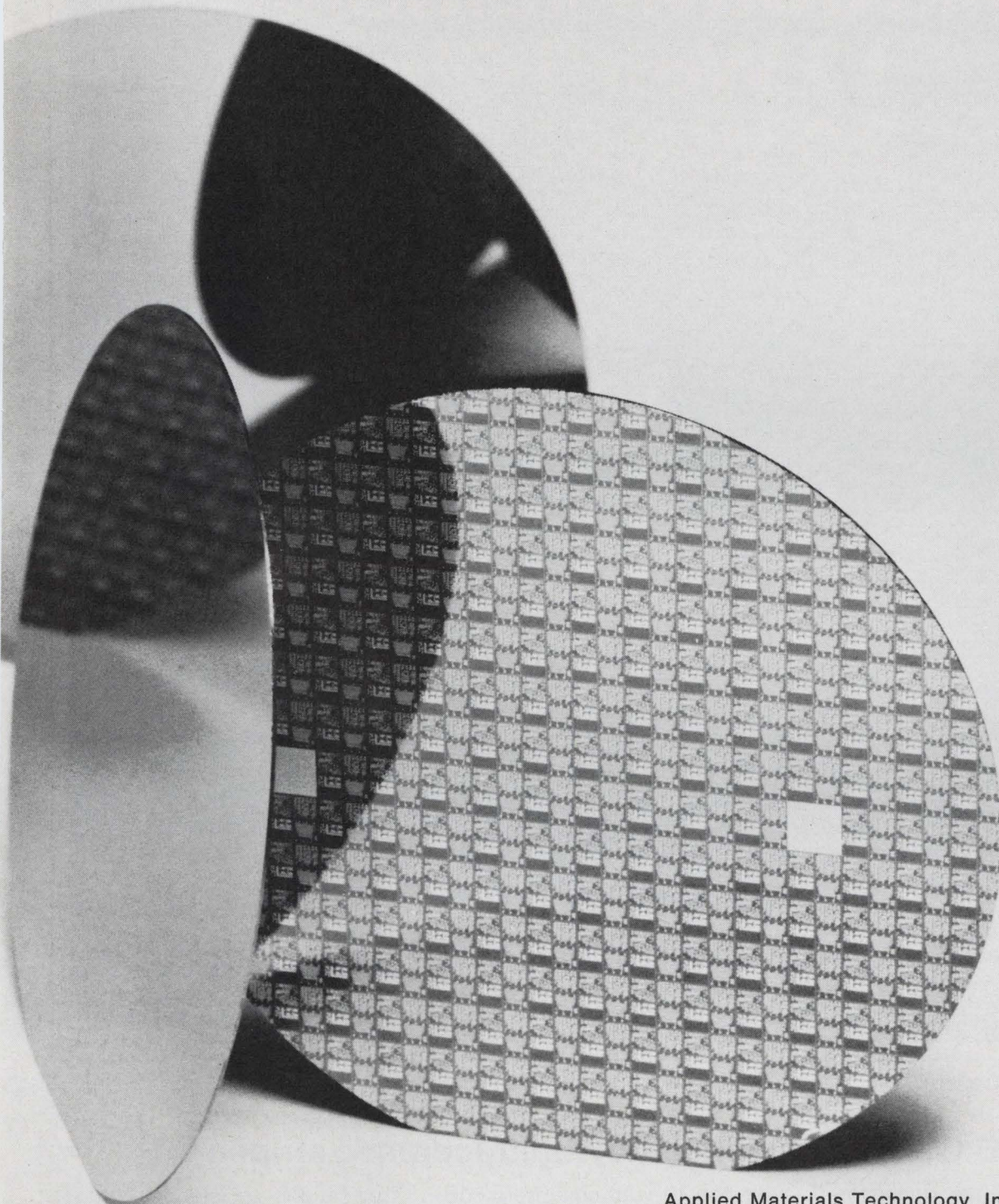

solely for exotic requirements. Backing up impressive technological accomplishments are the most rugged workhorses available for quantity production. Wafer to wafer. Run to run. You'll consistently produce better devices in thin film systems from Applied Materials Technology.

May we quote on your next purchase? Call collect for immediate requirements.

Applied Materials Technology, Inc., 2999 San Ysidro Way, Santa Clara, California 95051 (408) 738-0600 Telex: 34-6332 • 63 Route 206, Somerville, N.J. 08876, (201) 722-3300 Telex: 83-3439 • In Europe: Advanced Semi-

conductor Materials, Wokingham, U. K. Bilthoven, Netherlands; München, West Germany. In Japan: Kanematsu-Gosho, Tokyo.



applied materials

Circle 61 on reader service card

TRW Microwave Transistors 10 Watt-1 GHz 20 Watt-1 GHz

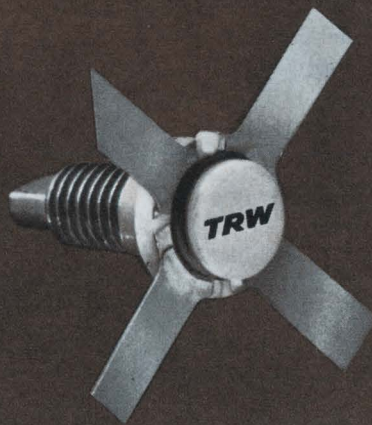

6dB Gain...50% efficiency...ultraceramic stripline

Two new microwave transistors have joined the TRW Gigahertz Family. Both the 10-watt 2N5595 and the 20-watt 2N5596 are in hermetically sealed ultraceramic stripline packages, offer excellent broadband capability, and operate from a 28 volt source. In class "C" common emitter opera-

tion, the 10-watt unit offers 6dB gain, and the 20-watt unit 5dB gain, with greater than 50% efficiency at 1 GHz.

Delivery is immediate...in production quantities. Order from the factory or any TRW distributor.

For complete information and

applications assistance contact TRW Semiconductor Division, 14520 Aviation Blvd., Lawndale, California 90260. Phone: (213) 679-4561. TWX: 910-325-6206.

TRW[®]

International Newsletter

March 2, 1970

Siemens moves toward American market...

West Germany's no. 1 electrical-electronics company, Siemens AG, is aiming for a larger share of U.S. markets. It has just concluded an agreement with the Allis-Chalmers Manufacturing Co., under which the Milwaukee-based firm will manufacture and sell a wide range of Siemens products on American markets. The actual licensing deal is expected to be signed later this year. The German firm says this is the first move towards eventual set-up of a joint Siemens-AC operation in the U.S.

Siemens, the world's second-largest exporter of electrical-electronics products—after Holland's Philips, has been only a light weight contender in U.S. markets so far. Last year's sales there amounted to slightly less than \$50 million and involved primarily medical electronics, electron microscopes, and special semiconductor devices.

... as well as toward avionics

Siemens and Britain's Ferranti Ltd. have agreed to cooperate in planning, developing, and manufacturing laser-based airborne navigational equipment for the MRCA, the multi-role combat aircraft which several West European countries intend to build for operation by the mid-1970's.

The deal brings together two top producers in their respective specialties. Ferranti is one of the foremost producers of avionics equipment, and Siemens is known for some pioneering work in lasers. A West German-British engineering team already is working out equipment proposals for various MRCA versions.

French discount goodies in Soviet's electronics bag

Judging from the larger space they've rented, the Russians will carry an even bigger bag of goodies to this year's Paris Components Show, April 3 to 8, than they brought last year, their first attempt to sell sophisticated circuitry to the West.

But, French electronics executives discount the Soviet move as propaganda. One French firm wrote Moscow after last year's show asking for quantity prices on several integrated circuits the Russians exhibited—and is still awaiting an answer. French executives say they've seen no signs that Moscow has sold advanced components in other Western European countries, though the Soviets took part in last May's London Electronics Show and then sent a components exhibit to Scandinavia.

Moscow has won minor orders for semiconductor crystals as a result of last year's Paris Show. France's Silec and Thomson-CSF have bought handfuls of Soviet silicon crystals, which their engineers call high quality. But, there have been no massive orders, at least in France. "Mainly we wanted to see if they were better than Western crystals," says a Silec spokesman. "They weren't," he adds.

GaAlAs joins GaAs in laser for British communications link

Lasers made from gallium arsenide-gallium aluminum arsenide may replace conventional gallium arsenide lasers in the optical glass-fiber-cable communications link being developed for the British Post Office [*Electronics*, Aug. 5, 1968, p. 267]. Researchers at Standard Telecommunications Laboratories Ltd. have managed to pull 8-watt pulses from 25 amps in duty cycles of 0.4% at room temperature. This compares with 6 watts from 60 amps from comparable GaAs lasers.

STL men believe that scaling down the GaAs-GaAlAs heterostructure

International Newsletter

to a 10-micron width would give 30 or 40 milliwatts in duty cycles of 25%, the level needed for a practical communications link. Degradation, which affects all GaAs-based lasers at room temperature and limits operating life to mere hours when run at duty cycles exceeding 20%, still must be overcome.

STL's heterostructure has a 2-micron p-type GaAs layer sandwiched between 3-micron layers of n-type GaAs and p-type GaAlAs. The laser action occurs at the GaAs p-n junction as in conventional GaAs lasers but the GaAlAs layer concentrates the active electrons into the thin central layer. That concentration increases gain and correspondingly decreases threshold current density to around 8,500 amps per square centimeter, which is about one-quarter of GaAs laser figures. The STL device runs cooler, is potentially capable of longer life, and shows reduced optical losses when compared to the ordinary GaAs laser's p-n junction construction.

Japan's satellite system seeks more industry money

The Japanese program to launch an experimental commercial communications satellite is slipping away from its 1974 launch date, concedes a delegate to the International Telecommunications Satellite Consortium's meeting in Washington. Funding is cited as the most critical problem for the Asian regional experiment, which envisions a system "with essentially an Early Bird capability." It's a problem which may have to be resolved by getting more financial support from industry for the satellite's organizer, the Outer Space Development Corp. Such a move would give industry a 40% participation—and possibly more—in the joint government-industry venture.

Sescosem building 2-kilowatt power transistor

France's leading French-owned semiconductor company Sescosem expects to have kilowatt power transistors ready for customers next year. The second-generation power device will go onto the market rated for 2-kilowatt operation at more than 100 volts. Cutoff frequency of the device will be some 20 megahertz.

Sescosem says that the transistor's high power-handling capabilities come mainly from a new package design that puts copper heat radiators atop emitter regions as well as next to the substrate. Also crucial is a pinhole-free solder alloy Sescosem engineers developed to join the copper radiators to the small silicon chip. The chip measures 15 by 15 millimeters.

Hawker-Siddeley and TRW conclude missile license

Hawker-Siddeley and TRW are joining forces to compete in the tactical missile business. TRW Systems Group, by signing a licensing agreement with Britain's Hawker-Siddeley Dynamics, has thus definitely thrown its hat into the tactical missile ring. The British firm has produced a number of air-to-air, air-to-ground and ship air-defense missiles, and is developing an advanced air-to-air weapon for Britain now, presumably the "taildog" missile.

The licensing agreement, under which Hawker-Siddeley Dynamics will provide TRW Systems with technical data, comes close on the heels of a request that TRW submit a proposal for the upcoming AIM-82 missile competition. The AIM-82 missile could be picked to go aboard the Air Force F-15.

French educators cast appreciative eye on sophisticated audio-visual systems

Teaching equipment represents one of France's fastest growing electronics markets; crowds at the educational electronics trade show seem to indicate there's a willingness to buy closed-circuit tv systems and problem-posing units

Until a few years ago, about the only audio-visual teaching aids used by tradition-bound schools in France were a blackboard and pointer. But things are changing fast—to the glee of electronics firms.

Thanks largely to student demands for better facilities during the May 1968 rioting, the model new university in the Paris suburb of Vincennes boasts an elaborate \$700,000 closed-circuit television system—one of the few in French schools. The system links a tv studio to 90 monitors spotted around the school.

Modern-minded educators in the Paris science faculty are experimenting with a 20-terminal computer-aided teaching system based on a big IBM machine. And an increasing number of schools are recording lectures by their eminent professors in up-to-date sound studios and sending tapes to less fortunate establishments around the country.

Growth. This new interest in sophisticated teaching equipment adds up to France's fastest-growing new markets for electronics. The market is hard to delineate and nobody knows its exact size. But everyone agrees it's growing fast—at a rate of at least 25% a year, figures Maurice Fromaget, head of the new Thomson-CSF audio-visual division. Along with the schools themselves, French audio-visual equipment makers are pushing their wares to corporate customers for factory training programs and even supermarket promotions.

Underscoring the trend toward electronics in the classroom, equip-



Closing the circuit. Viewers at the Paris show had a chance to try out a closed-circuit tv console with mixing and special effects controls.

ment makers organized France's first educational electronics trade show in Paris in February. The show attracted some 40,000 customers, double the number many exhibitors expected. The blossoming of costly and complex machinery, much of it computer-inspired, indicated electronics firms are confident French schoolmasters have reached a new level of sophistication in their teaching methods.

Sintra, for example, feels sure it can sell more than 5,000 of its new \$2,700 problem-posing machine—a complex version of the electric probe-matching game children used to play to solve a card full of riddles. Sintra, a 1,000-employee firm that's done considerable military systems work and has to its credit France's air-defense network, packs a lot of logic into

its Mitsi 2023. Two hundred Fairchild TTL integrated circuit packages sort out right and wrong answer as students work their way through a strip-film and magnetic-tape instruction program.

Because of its load of logic circuitry, Sintra's machine can cope with a variety of answer inputs. Students answer test questions after each instruction block by setting 15 slides, each of which has 140 symbols—upper and lower-case alphabets, numerals, and mathematical symbols. If the answer is wrong, it's analyzed by the logic circuitry, which then signals the film and tape where to go for the instruction segment that should guide the student to the right answer. The complexity of the repeat sequences—branching, in audio-visual jargon—depends on the

program. A single film cassette can provide up to 127 frames and the sound tape can run as long as 20 minutes.

Sintra designed the machine to be computer compatible. Up to 64 of them can be tied to a small general-purpose computer. That way, the work of as many as 1,000 students a day can be recorded, analyzed, and printed out for instructors. A system comprising eight machines and a Nixdorf 820 computer will be tried out in a Paris vocational school this year.

Right or wrong. A less ambitious teaching machine has been put together in prototype by Thomson-CSF. The unit contains a small cassette tape recorder which asks students questions over a loudspeaker or earphones. Students answer by typing on an electric keyboard. MOS memories compare the response with the right answer, and comparison develops signals that drive "right" or "wrong" indicator lamps. If mass-produced, the machine would sell for around \$600, company officials estimate. They think market soundings will reveal demand in rural schools, where a teacher handling several grades could tie some students down to the machines while he teaches others.

Despite the entry of calculators and computers into the teacher's method repertoire, Thomson-CSF closed-circuit tv is the backbone of the educational electronics business for a long time to come. To offer theatrical-minded educators the possibilities of bigtime tv studios, the company has developed a new miniaturized mixing and special-effects console. Six buttons let an operator split and merge different images, as well as point an electronic spot. The transistorized unit, which contains a few integrated circuits in its special-effects logic circuitry, measures only 10 by 30 by 6 inches in its largest version, which can handle eight video channels. An audio panel of similar size controls four audio inputs.

The company plans to offer the control console in a educational tv studio package that will include two cameras, a document reader, six 12-inch-screen tv monitors and

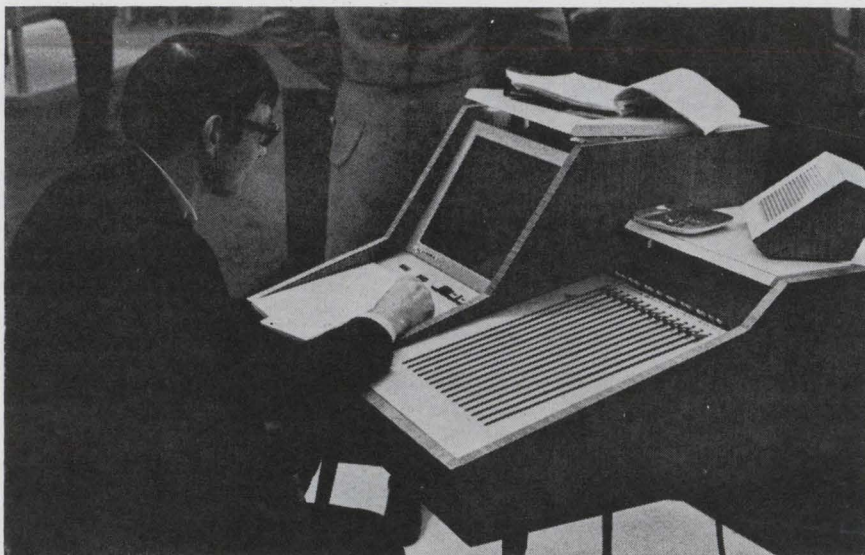

Am I right? Prospective customer ponders the merits of Sintra's machine, which, given a wrong answer, decides how many teaching steps to repeat.

the video and audio control consoles—all for a \$20,000 pricetag. The package will be marketed throughout Europe and in developing countries, where Thomson-CSF sees a big market.

To tap factory training and other adult education markets, Thomson-CSF has signed an accord with France's nationalized tv network, permitting it to tape technical courses broadcast by a government training school and then rent the tapes—with video recorders, naturally—to industrial firms for worker education programs. The company itself has started giving its production workers a wiring course cribbed from the French tv network.

Thomson-CSF has also bought rights to sell and possibly manufacture CBS's new electronic video recording system in France. "Educational television is just starting in France," beams Thomson-CSF audio-visual boss Fromaget.

Great Britain

Pewter power

Lead-tin telluride has come of age as an infrared radiation detector. Britain's Plessey Co. not only lays claim to being the first to offer detectors of the material, but is offer-

ing the semiconductor elements in six- or eight-unit arrays.

With a peak sensitivity at about 10 microns, the detectors are competitive with those made from mercury-cadmium telluride. Plessey says the new detectors already perform as well as the competitive devices, but cost about 30% less. Plessey researchers figure the new material will soon surpass photoconductive mercury-cadmium-telluride detectors in specific detectivity—the basic measure of sensitivity—because it operates in photovoltaic mode, which is inherently capable of higher specific detectivity than photoconductive detectors.

Lead-tin telluride is advantageous because diodes can be fabricated from epitaxial layers grown on single crystals. The performance of diodes from the same layer is essentially uniform and an array is easily mounted on a common substrate. Mercury-cadmium-telluride detectors, on the other hand, have to be carefully selected for uniform response from chips of the same crystal. Each detector in an array has to be treated independently, with its own output leads and bias supply.

Seeking orders. Plessey has supplied lead-tin-telluride detector samples to the military for evaluation and also to some universities and astronomers. The company is

looking for production orders in quantities of 10 to 20 at a time, and is quoting prices of something under \$2,500 for single detectors. The price will be perhaps two or three times that for 6-by-1 or 8-by-1 arrays.

The great advantages of both mercury-cadmium telluride and lead-tin telluride are that they will work at liquid nitrogen temperatures and that they have very good response at around 10 microns wavelength. This is a peak-emission wavelength for i-r radiation from buildings, vehicles, and people. The materials can also have response times down to 10 nanoseconds.

Hence, a lead-tin-telluride array can be used as a highly sensitive line-scanning detector in an aircraft, where fast response is essential for good resolution. In another application being tried out, Plessey diodes function as heterodyne detectors in communication systems based on carbon-dioxide lasers, which peak at 10.6 microns.

Varying peaks. Plessey starts with a lead telluride substrate onto which lead-tin telluride is transferred by vapor transport. John Bass, who's in charge of the work, says the proportions of lead, tin, and tellurium in the vapor remain the same in the resulting epitaxial layer, which eases the task. The peak-response wavelength can be varied between about 8 and 12 microns by varying the proportions of lead and tin. The same effect can be obtained in mercury-cadmium telluride by varying the proportions of mercury and cadmium, but, according to Bass, it is much more difficult to achieve uniform control of proportions in a growing crystal than during epitaxy.

The substrate is etched away from the epitaxial layer, which is then annealed to reduce carrier concentration. The p-n junction is formed by diffusing more lead or more tin to change the ratio of metal to tellurium. The wafer is metalized and cut up. The chips are mesa etched into discs about 20 mils in diameter and the contacts attached to the metal by hand. Then the diodes are assembled into

arrays and the array packaged in a double Dewar with a silicon window and a silicon heat sink. Thus far, the leads are all individual, but the intention is to develop integral scanning circuitry.

Bass says that any six or eight diodes from an array will not vary in response by more than 20% and in quantum efficiency by much less than 20%. Peak specific detectivities thus far achieved have been around 2.6×10^{10} cm $\text{hz}^{1/2}$ /watt at 77°K and with a 180° field of view.

Great Britain

GaAsed-up ignition

The contact breaker points are a weak link in an automotive ignition system. There have been many proposals to use electronics to cut down the work the contact points have to do, and even to eliminate them completely. So far these alternatives have not made much impression on the market because of higher cost—and the auto industry weighs every fraction of a cent.

Manufacturers and accessory companies offer electronic ignition as an option, however, at extra cost. Now, a British automotive parts wholesaler, Autocar Electrical Equipment Co., intends to enter this field with a completely breakerless ignition system. Its breaker action is provided by a mechanical chopper cutting an infrared light beam generated by a gallium arsenide diode.

Autocar's system, called Lumenition, will be offered as a \$40 replacement kit for the conventional coil, breaker points and capacitor in a standard distributor. The chopper is a disk with lobes equal to the number of cylinders in the engine, and it fits on the cam atop the distributor shaft, which is ordinarily used for opening and closing points. One of the holes in the distributor base plate, which normally takes the breaker points, holds a bracket with the GaAs light source and a phototransistor.

In addition, there is transistorized switching circuitry on a thick-film

substrate attached to the bracket. When the chopper breaks the beam the detector output ceases. Actuating the switching circuitry and cutting the power transistor current to the primary winding of the coil. Consequently, a high voltage is generated in the secondary winding, in the usual manner. The coil actually has fewer primary turns than is normal, to get a fast secondary rise time and a strong spark from a fouled plug. This is a bonus not always found in normal points, which can not take the high current required.

Pointless. Autocar's system completely eliminates contact points, and Eric Ford, managing director of Autocar, notes that as cars are built to require less and less general maintenance, the conventional points will stand out more and more as old-fashioned. The transistor-assisted points systems cut down the worst problem—pitting and corrosion—by shunting only a small current through them and feeding most of it through transistors. But they don't get over the need for frequent adjustment. The Lumenition system, like other experimental breakerless systems, is claimed to be maintenance free. Further, it's free from the limit on engine speed imposed by bouncing or sticking points. At the low-speed end it gives a faster switch and therefore can induce a spark where the standard systems cannot.

Though Britain's volume car producers have Lumenition systems for evaluation, Autocar's Ford does not expect them to come rushing yet. At current component costs, it would add something like \$15 to the price of the ignition system. Ford says the difficult components are the gallium arsenide light cell and the power transistor. If volume production could slash the price of these devices, the system cost might get to within a few dollars of conventional system. At this level the ordinary motorist might feel the benefits are worth the extra price, believes Ford. But initially, he feels the system will find applications in the high-performance replacement market.

Though basically simple, removing bugs from the system has re-

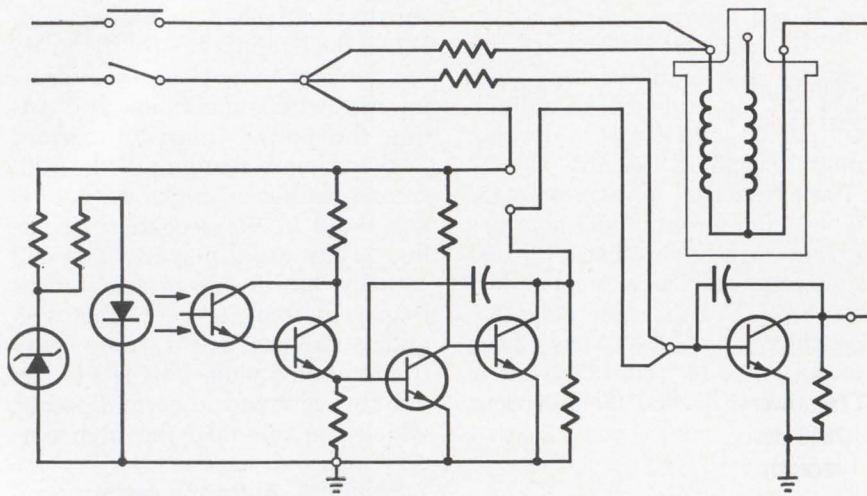

Tripping the light fantastic. Beam from GaAs light emitting diode is interrupted by chopper disk attached to car's distributor rotor.

quired some work. The GaAs i-r lamp, supplied by International General Electric Co., and the photodetector are inherently highly sensitive devices—much too sensitive on their own for an automotive environment. Unavoidable random voltage changes and stray induced currents would play havoc with control of the system if not neutralized.

Hence the lamp has had to be stabilized with a zener diode, and the photodetector is arranged as a Darlington amplifier, switching 40 milliamps instead of the few microamps characteristic of a single photo-transistor. Similarly, the power transistor is protected against the spike voltage induced in the primary coil winding immediately after switching by a resistor-capacitor circuit matched to the transistor characteristics. A feedback link in the thick-film transistor switching circuitry provides equally fast switching at all chopper speeds.

West Germany

Pulsed i-r link

Communications engineers encounter problems in designing data transmission systems for use in steel plants, foundries, mines, or similar places. Automated techniques often call for data trans-

mission between moving machinery and a fixed installation, but rough environmental conditions make conventional wire or radio-based links unreliable. Drag cables and inductive loops that sometimes are used are subject to wear and tear, and radio often is out of the running because of the small number of frequencies postal authorities in Europe set aside for industrial purposes.

One obvious way to sidestep these problems would be to use optical techniques—that's the approach engineers at the Research Institute of West Germany's Association of Foundry Workers have taken. The system they've developed can send either analog or digital data over distances of up to 500 yards. What's more, the system permits reliable communications even when heavy smoke or thick dust cuts signal strength to less than 4% of its nominal value.

To make the system work under conditions like that, its developers have resorted to pulse-frequency modulation, which hasn't been used in an optical transmission link before, according to the association's researchers. In pfm, the information to be transmitted is a function of the rate at which pulses are sent. Unlike amplitude modulation, it's independent of the amount of energy that reaches the receiver. And compared with other pulse-based modulation schemes, pfm requires a lot less circuitry

and its noise immunity is higher.

The system operates in the infrared range at wavelengths around 0.9 microns. It features a bandwidth of 11 kilohertz, allowing simultaneous transmission of 16 binary signals in frequency multiplex and permitting one-channel voice communications as well. Work is now under way to modify the system for considerable higher bandwidths—up to 5 megahertz—so that tv signals can be sent.

The key element of the transmitter is a gallium arsenide luminescence diode installed at the focal point of an 8-inch-diameter parabolic mirror. The signals to be transmitted are fed to an astable multivibrator which serves as a voltage-to-frequency converter. In the absence of modulation this converter delivers a train of pulses with a repetition rate of 50 khz. When the system is modulated, however, the rate varies between 40 and 60 khz. The amount of change depends on the amplitude of the signals fed to the converter.

The converter output is amplified, fed to a pulse transformer, and is then used to excite the GaAs diode. The transmitter's power is between 10 and 20 milliwatts.

At the receiver. The frequency-modulated pulses hit a 12-inch diameter parabolic mirror which has a silicon photodiode at its focal point. This diode acts as a radiation-dependent current generator and is part of a parallel resonant circuit which is tuned to a 50 khz center frequency. After being amplified and differentiated the signals are fed to a simple low-pass filter for demodulation.

Both the transmitter and receiver are housed in waterproof units slightly larger than headlights.

The new system, now undergoing tests in a steel plant in the Ruhr area, has been specifically designed to transmit weight information from a crane to a stationary vessel below. But its developers say that it has a much wider range of application. The system could be used, for example, in point-to-point voice communications in rough terrain with noisy environments.

No Other UJT Source Can Price This Make:

Unsurpassed unijunction transistors at unprecedented low prices . . . what could be better?

Immediate delivery from an uncommitted, million-and-a-half-unit Motorola UJT factory inventory, that's what!

2N2646 — the only available industry standard for 67¢

We have, in fact, over ¾ million of the ever-popular, industry-standard, 2N2646 devices now in scarce supply elsewhere — and all have recently been tagged with a new, low, 67¢ price. Right now, Motorola UJT's are more economical to design in than ever . . . and **right now** you can get any of these preferred Annular* types in more than ample lots to supply virtually any new and existing design — with important performance bonuses.

2N5431 — the only 4V UJT for \$2.35

For example, your requirements for ultra-low-voltage applications will be immediately satisfied with the 2N5431 furnishing 4 μ A peak point current at 4V V_{B2} , 6.0 to 8.5 R_{BB} spread and 0.72 to 0.80 eta ratio, plus 10 nanoampere I_{EB2O} .

2N4851/52 — the only "minutes-to-microseconds" UJT for 65¢

You can use the 2N4851 series in a wide range of pulse, timing and sensing applications; with 2.0 μ A peak point current and low typical leakage it's ideal in long-time delay circuits.

2N4871 — the only plastic UJT for 45¢

And the all-around 2N4871 furnishes you a wide choice of HF oscillator, time delay and SCR trigger application possibilities with a 100-up plastic price of just 45¢!



MOTOROLA Unijunction Transistors

Contact a Motorola representative today for your large quantity needs . . . write Box 20912, Phoenix, Arizona 85036 for data.

Motorola UJT's mean low price, top performance . . . and immediate delivery!

No other UJT source can make that statement.

*Patented process
All prices shown are 100-up

**Isn't the logical place to get amplifiers
for seismic monitoring systems the company
that has already delivered thousands of them?**

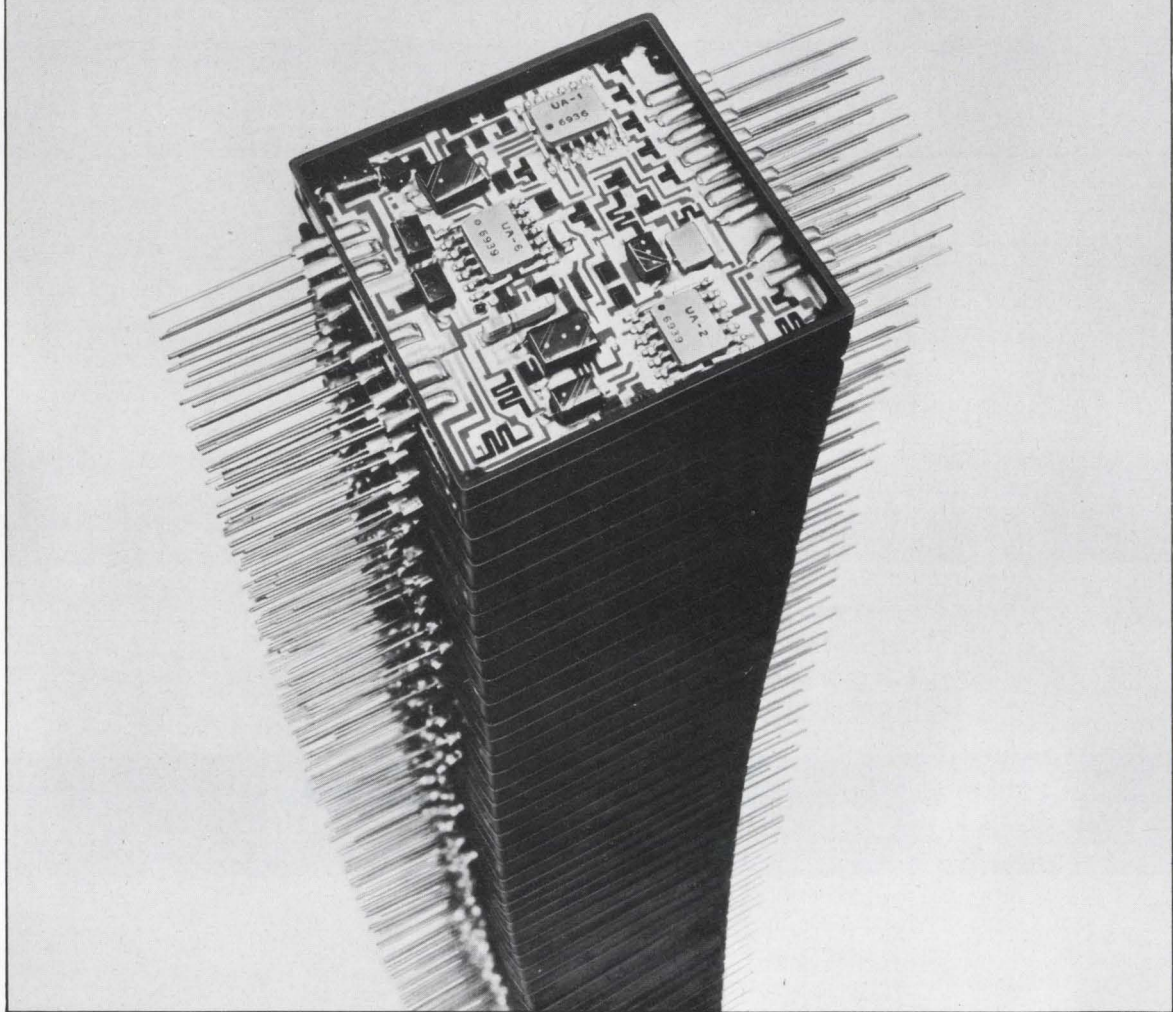

United Aircraft H2181 and H2191 Amplifier/Pulse Generators and H2105 Amplifiers are rugged, thick film hybrid microcircuits. The H2181 and H2191 are designed to work with seismic monitoring systems and produce a pulse whenever a low level signal reaches a set level. The threshold can be set over a 40 dB range in 8 dB steps. The H2105 Amplifier is designed to operate with a dynamic low impedance microphone, and its nominal gain is 100 dB at 1 KHz.

These 1.6" x 1.6" x .22" devices are designed to withstand severe shock, to have a high immunity to noise, and to draw extremely low power. The H2181 and H2191 draw less than 500 μ A on standby and 1 mA when pulsing. The H2105 draws 850 μ A.

Because they are currently being manufactured in high quantity, the H2181, H2191 and H2105 Amplifiers are available fast, and at remarkably low cost. Seismic monitoring is our business, so write for complete information.

Electronic DIVISION OF **United**
Components **Aircraft**

TREVOSE, PENNSYLVANIA Tel. 215-355-5000 TWX: 510-667-1717

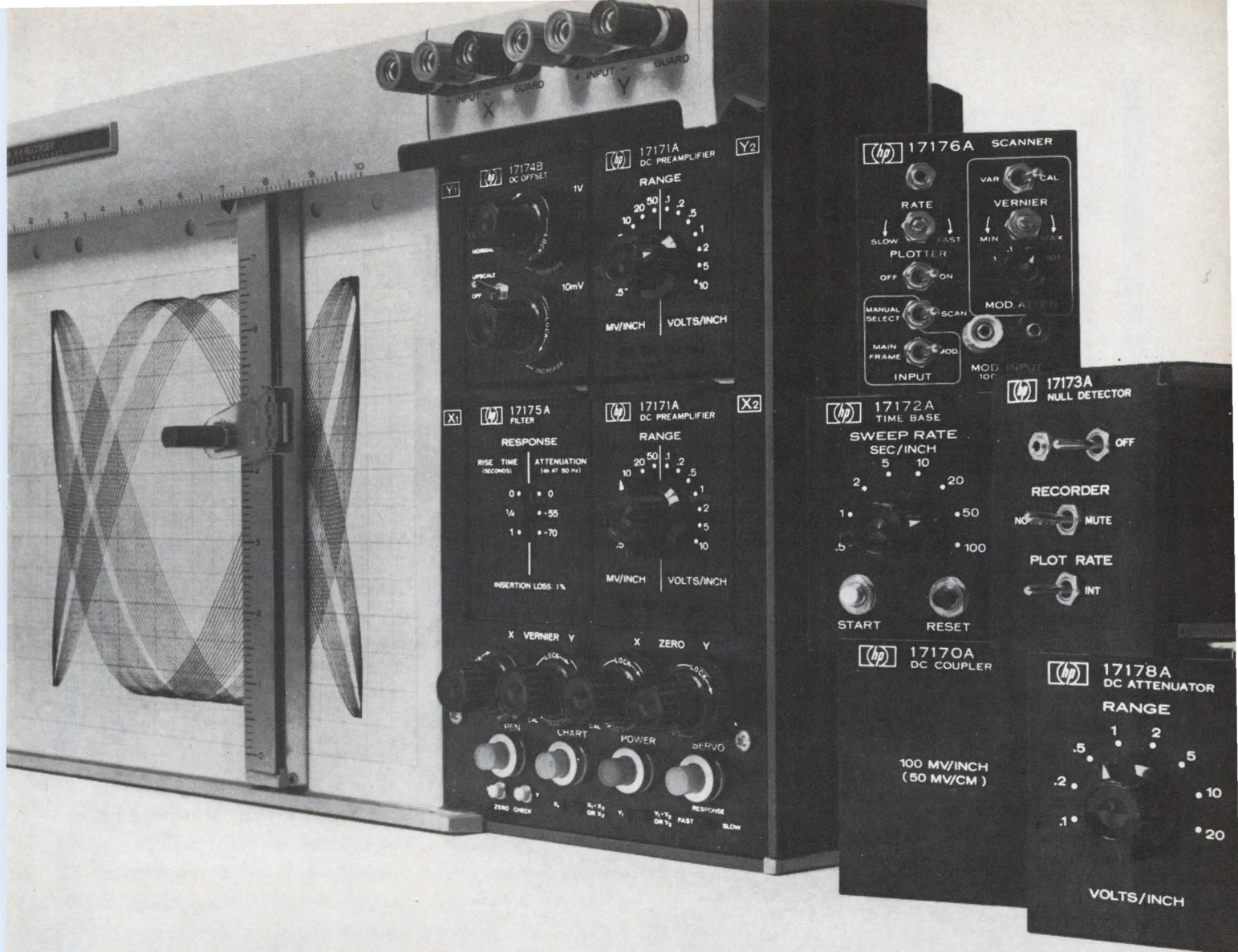

To make our new small X-Y Recorder act big, just plug in a couple of these.

HP's new 7034A is as trim as you can make an 8½" x 11" X-Y recorder. But size is the only thing small about it. The frame has all the features and versatility of our big X-Y Recorder. Such as 1500 in/sec² acceleration and 30 in/sec slewing speed, to catch transients most X-Y recorders miss. Guarded circuits to reject ac and dc common-mode signals.

Exclusive, silent electrostatic paper hold-down to eliminate slippage. Disposable ink cartridge to eliminate mess and make color changes easy. And zero set/check for fast verification of zero position without removing or shorting the input signal.

High dynamic performance is

matched by the flexibility we've achieved with our unique plug-in concept: two may be used in each axis, and can be cascaded. With eight plug-ins to choose from, you can add to your measurement capabilities as the need arises.

With the Time Base plug-in, you can capture X-T or Y-T data at ½ sec/in to 100 sec/in sweep rates. Expand low-level signals for detailed study with the DC Preamplifier. Suppress steady-state dc to reveal small-signals using the DC Offset plug-in. Plot single channel data at 50 points/sec with the Null Detector and accessory point plotter. Plot two channels independently with the Scanner.

Eliminate ac signal components over 50 Hz with the Filter plug-in. And for more run-of-the-mill recording jobs, try our low-cost DC Attenuator or DC Coupler.

You'll be glad to know that the price on this new X-Y Recorder is also small: just \$1195 for the basic instrument. Plug-in prices start at \$25. For all the big details, contact your local HP field engineer. Or write to Hewlett-Packard, Palo Alto, California 94304; Europe: 1217 Meyrin-Geneva, Switzerland.

HEWLETT  **PACKARD**

GRAPHIC RECORDERS
Circle 71 on reader service card

New S. S. White system trims microelectronic hybrid resistors at 1,000 per hour...or more



If you're into hybrid circuitry in a big way, or hope to be, our Model AT-701AR may be just what you need. It offers high capacity, accurate trims, high yield — or, just what you need to keep your customers and your comptroller happy.

Model AT-701AR is similar to our highly successful Model AT-701A, but with the addition of a rotary feeding system which lets operator load and unload substrates during the machine's trimming cycle. Capacity is limited only by the man-

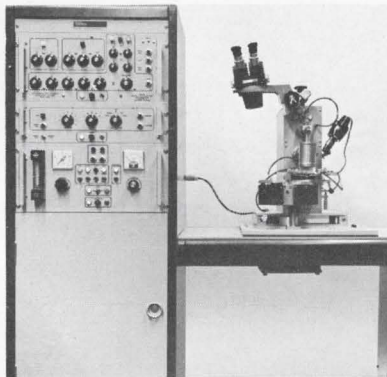

Model AT-701AR

ual dexterity of your operator.

Accuracy of the AT-701AR is guaranteed—within 0.5%. 0.1% is attainable with care and some sacrifice of speed. Trimming is monitored by a precision system of electronics featuring a four-wire Kelvin bridge, and tolerances may be programmed from $\pm 0.1\%$ through $\pm 11\%$. (No use making them better than the specs require!)

But suppose the Model AT-701AR is too big or too small for you?

Call us anyway. If you can get by with something like 600 accurate trims an hour, we can offer you our Model AT-701A, to which you can add the turntable feature later. If you're still experimenting, we have Model LAT-100 for breadboarding. It is accurate to 1% better, takes substrates up to 4 x 4 inches and sells for only \$5,950. If you're *really* big, there's the Model AT-704A, a rotary-feed

machine that trims four resistors simultaneously, monitors, and inspects them at the breathtaking rate of 4,000 per hour. And if *that's* not fast enough for you, buy two.

All the S. S. White resistor trimming systems are based on the proven Airbrasive[®] method of removing resistance material which produces neither heat nor shock, does not alter the substrate.

Call 212-661-3320 to arrange for a live demonstration. Speak to Hal Skurnick or Nick LaCourt. These same gentlemen will be demonstrating the Model AT-701AR and the Model LAT-100 at major electronics trade shows around the country, and if that's not quick enough for you, we will arrange for you to visit our factory. We have also prepared an extensive technical bulletin on this equipment, called, rather cryptically, the "RT-14", a copy of which is yours for the asking.

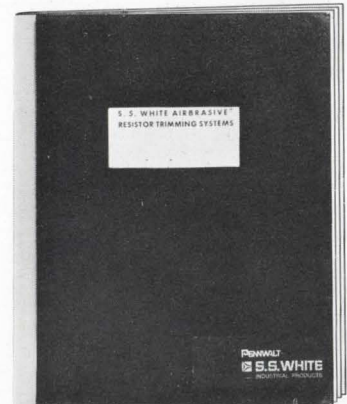

RT-14

Write to S. S. White Division, Pennwalt Corporation, Dept. R, 201 East 42nd Street, N.Y., N.Y. Tel.: 212-661-3320

SEE US AT IEEE
SHOW BOOTHS IC-32-34

PENWALT
S.S. WHITE
INDUSTRIAL PRODUCTS

Full performance at a price you can afford



You don't have to be a Scotsman to know that you pay more for top performance. So if we told you this new 3-digit DPM was made to sell for less than \$115 in OEM quantities, you'd figure its performance at something less than that delivered by our higher priced models.

But you'd be wrong. And here's why. First of all, our initial objective was to develop an instrument for OEM measurement needs of the scientific and medical community. Obviously, price was an important factor. But so was performance. The happy solution

was to eliminate a few of the more exotic functions that these users normally don't require. For example, 100% overrange and standard BCD output (an option available on Model 1261).

Secondly, instead of compromising performance, we've actually *improved* it! Model 1261 is a basic 0-99.9 millivolt DC meter with 50% overrange capability, 100 microvolt resolution, long-term stability, 50 megohm input impedance, high rejection characteristics, and Weston's patented dual slope* circuitry. It's packaged in the plug-in case that's common to all our

DPM's, giving you Weston front panel serviceability.

This latest addition to our DPM family brings .1% accuracy within range of practically everyone's budget. Make your own comparisons, spec for spec, with other digital compacts on the market. Write today for complete data and ranges available.

WESTON INSTRUMENTS DIVISION,
Weston Instruments, Inc., Newark, N.J.
07114, a Schlumberger company

WESTON®

*U.S. Pat. #3,051,939

circuit problems?



ultra-high leakage resistance

Devices with leakage resistance in excess of 10^{12} ohms are available for circuits requiring this property. Such applications would include sample and hold for A to D conversion, and capacitor memory systems. See Signalite Application News for typical applications.



voltage regulators better than 1% accuracy

These subminiature voltage regulators are used in regulated power supplies, as reference sources, photomultiplier regulators, oscilloscopes, calibrators, etc. They are available in voltages from 82 to 143 V. They are used in multiples as regulators in KV ranges. See Signalite Application News for typical applications.



photo-cell applications

The A074 and A083 have been designed for use with Cadmium Sulfide or Cadmium Selenide photo-cells. Applications include photo choppers, modulators, demodulators, low noise switching devices, isolated overload protector circuits, etc. Speed of operation is limited only by the photo-cells. See Signalite Application News for typical applications.



neon timers

The bi-stable characteristics and high leakage resistance of Signalite's special glow lamps make them ideal as a component for timing circuits. The basic circuit resembles a relaxation oscillator network. See Signalite Application News for typical applications.

Signalite

glow lamps have solved problems in these areas:

- Voltage Regulation & References
- Photo-Cell Drivers
- SCR Triggering
- Timing
- Photo Choppers
- Oscillators
- Indicator Lights
- Counters
- Voltage Dividers
- Surge Protectors
- Logic Circuits
- Flip-Flops
- Memory
- Switching
- Digital Readouts

Signalite glow lamps combine long life, close tolerance and economy, and are manufactured with a broad range of characteristics to meet individual application requirements. For a creative approach to your design problem . . . contact Signalite's Application Engineering Department.

SIGNALITE APPLICATION NEWS —



is used to communicate new and proven techniques and applications of Signalite's neon lamps and gas discharge tubes. Signalite Application News provides a forum for an exchange of ideas to keep the design engineer aware of the versatility of neon lamps and their many applications. Copies are available from your Signalite representative or contact Signalite.

Circle 513 on reader service card

A GENERAL INSTRUMENT COMPANY



Signalite

INCORPORATED
1933 HECK AVE., NEPTUNE, N.J. 07753
(201) 775-2490

317

With due respect to Hewlett-Packard, General Radio, and other "biggies"



LogiMetrics audaciously introduces the world's most accurate RF signal generator with continuously viewable (non-ambiguous) display.

- Unprecedented stability and resolution ● No separate counter or accessory equipment required
- A true combination of improved performance and reduction in cost!

Until now, a signal generator with an accuracy of 10,000 parts per million was considered acceptable. LogiMetrics' new 920A RF signal generator automatically, directly, and continuously measures the frequency to an accuracy of 60 parts per million (0.006% of full scale)! Think about that. Accuracy to 10,000 parts per million now improved to 60 parts per million, taking into account error due to all causes.

PATENTED IMPROVEMENTS AND EXCLUSIVES The 920A provides a significant improvement in accuracy, resolution, and repeatability due primarily to a patented new feature, ddc™—direct digital calibration. (There's no dial at all.) The frequency generated is displayed visually—to four significant digits. The frequency you see is the frequency you're getting—continuously! In addition, leveling is accurate to $\pm 1/2$ dB across the complete spectrum of the generator and at all output levels. Modulation capability provides unmatched AM performance with both internal 400/1000 Hz modulation or external.

CLEANER AND MORE FLEXIBLE Unwanted spurious by-products are practically non-existent. For example: hum and noise, 70 dB down; residual or incidental FM, 1PPM; RFI leakage, better than MIL-I-6181D. That's performance! The unique design (primarily integrated circuit), makes calibration a snap. It also facilitates a range of options including computer and/or printer compatible read-out of frequency and narrow band frequency programming.

ASK US! If accuracy counts in your laboratory, write or call for catalog data describing LogiMetrics' "ddc" signal generators from 100 kHz to 80 MHz. Or use reader service number below.

Comparative Costs:

Conventional signal generator	
plus separate counter (typical)	\$3,500.00
LogiMetrics Model 920A	\$1,975.00



LogiMetrics INC.

A Subsidiary of Slant/Fin Corp.
100 Forest Drive, Greenvale, New York 11548
Phone: (516) 484-2222

Circle 75 on reader service card

FACT!

UTC HAS MORE TRANSFORMERS & FILTERS LISTED ON THE QPL* THAN ALL OTHER MANUFACTURERS COMBINED

Here's proof that United Transformer is Number One.

Exactly 53.73% of all transformers, inductors, and filters on the Qualified Products Listings are made by UTC.

This extensive listing enables you to meet most requirements for qualified inductive devices. It also helps you to avoid the high costs and long delays in establishing qualification.

UTC is also Number One, with the widest selection of catalog parts in the industry. All UTC parts are made in the same facility and with manufacturing procedures similar to those used in making QPL parts—substantiating our claim to the highest quality in the industry.

To fill your present or next requirement, check your distributor for off-the-shelf delivery. Or, contact United Transformer Company, Division of TRW, INC., 150 Varick Street, New York, N.Y. 10013.

TRW
UNITED TRANSFORMER COMPANY

*Reference to the total items listed on Qualified Products Lists: (1) MIL-T-27, QPL-27-48 (transformers and inductors—audio, power, and pulse); (2) MIL-F-18327, QPL-18327-20 (filters: high pass, low pass, band pass, band suppression, and dual functioning); (3) MIL-T-21038, QPL-21038-13 (transformers, pulse, low power).

Washington Newsletter

March 2, 1970

Impossible dream: Comsat, AT&T in bed

Communications Satellite Corp. sources say the company is talking with AT&T about "a joint effort" in the launch and operation of a domestic satellite system. At the same time, Comsat is talking about a similar venture for tv transmission with the three commercial broadcast networks. However, Comsat says it will have to choose soon which partnership to pursue, since "we obviously can't have it both ways." Comsat clearly indicates it tends to favor the AT&T relationship—a surprising development in view of the running battle over such issues as division of communications services between satellites and cables. However, capital communications specialists say Comsat is going to have to make a deal with someone on domestic satellites if it expects to remain in competition after the recent White House recommendation to the FCC that anyone with knowhow and the money can launch a domestic system [*Electronics*, Feb. 2, p. 125].

U.S. optimism rises at Intelsat parley

Watch for the United States to hold its ground on the sticky issue of the management role to be played by the Communications Satellite Corp. in the International Telecommunications Satellite Consortium now meeting in Washington. The conference, scheduled to conclude March 17, is trying to reach a permanent agreement on the structure and operation of the Intelsat system. The U.S. delegation, supported by many Latin American and some African countries plus a few in Europe, favors retention of Comsat on a permanent basis while others, led by France, West Germany, Britain, and Switzerland, are bitterly opposed.

Though the U.S. is willing to accept some compromise, it is becoming more firm in its support of Comsat. Says one U.S. delegate, "The other side, as Dean Rusk used to put it, is having increasing difficulty convincing people that we're the bad guys." The possibility still exists that the meeting will wind up without an agreement. But, since the American delegation sees another standoff as damaging to U.S. interests in the long term, pressure is building on the American side for a permanent agreement.

Laird plans new communications post

Defense Secretary Melvin Laird is pulling together all military communications responsibility under a new civilian post to be titled either Assistant to the Secretary of Defense for Communications or Deputy Assistant Secretary of Defense (Communications). The only reason why the new job will not have the status of Assistant Secretary of Defense is a legal one—the Pentagon is limited by law to the seven assistant secretaries it now has. An appointment to the new job is expected soon.

ATA, Arinc to carry frequency fight to world group . . .

Look for the Air Transportation Association of America and Aeronautical Radio Inc. to continue their fight to develop an exclusive space communications system for satellite-relayed, over-the-ocean navigation and air traffic control, despite an adverse ruling by the FCC. Overriding ATA-Arinc objections, the FCC unanimously decided that the airlines must share a portion of the uhf space techniques bands (1,535-1,537.5 and 1,637.5-1,660 Mhz) with maritime mobile radio. The ruling is effective April 1. Airline industry arguments lacked both persuasion and

Washington Newsletter

technical justification, the FCC said.

Both the ATA and Arinc said they will "continue to press industry objectives" until the issue is settled at the International Telecommunication Union's World Administrative Radio Conference on space services in 1971. However, one airline spokesman pointed out that shared development and use of such a system would mean lower costs, perhaps a closer operational system, and a unified front before Congress and government agencies.

... and doubt FCC will reconsider

The airlines discount the FCC's sweetener—"When viable space systems have been developed and sufficient experience has been gained, further subdivision may be reconsidered." The airlines, however, support the FCC's suballocation of the 1535-1660-Mhz aeronautical radionavigation band to accommodate exclusive airline development of an aircraft collision-avoidance system at 1592.5-1622.5 Mhz and for glide slope operations in the 1557.5-1567.5-Mhz band.

Since the International Civil Aviation Organization already has proposed sharing the space techniques frequencies, the decision was not expected to become an issue at the Paris meeting Feb. 23-March 4 on the application of satellite techniques. The panel is discussing the problem whether a uhf, vhf, or hybrid navigation-ATC satellite should be flown over the Atlantic or Pacific or both.

Raytheon's 'burr': Sanders to get FAA display backup job

The Federal Aviation Agency will fund a development contract with Sanders Associates of Nashua, N.H., for a data display system for possible use in the en-route portion of the advanced National Airspace System [*Electronics*, Jan. 19, p. 33]. FAA administrator John H. Shaffer characterizes the Sanders effort a "burr under the saddle" of the Raytheon Co., which so far has failed to produce a satisfactory computer display.

Despite FAA's threat to cancel the Raytheon contract, the agency signed an agreement with the Massachusetts firm Feb. 13 to develop a new prototype display "within the terms of the existing contract." During recent Congressional hearings, the FAA said it had seen "very little improvement from November" and that the Raytheon displays were "still far short of meeting Government quality standards."

In reply, a Raytheon spokesman said that "very significant progress" toward reliable operation of the displays has been made in the last several months and that the company fully expects to meet what it describes as "the true needs" of the FAA. The company said that the digital equipment portion of the work—representing 85 per cent of the contract—"is proceeding well."

Buck-passing 1970: 'computer error'

If the computer industry expects to maintain a favorable image on Capitol Hill, it should fight back when the Pentagon blames human errors on its computers, warns the Joint Economic Committee's defense economist Richard Kaufman. The Defense Department is a classic example of the "growing tendency among bureaucrats to blame their own mistakes" on a computer, Kaufman says, and the industry is making a mistake by letting itself become the Pentagon's new "whipping boy." What about the Congress? Kaufman doubts it will make a legislative whipping boy of its computer system [*Electronics*, Dec. 8, 1969, p. 41].

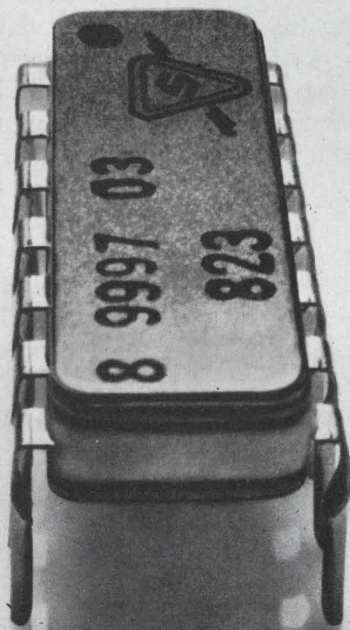
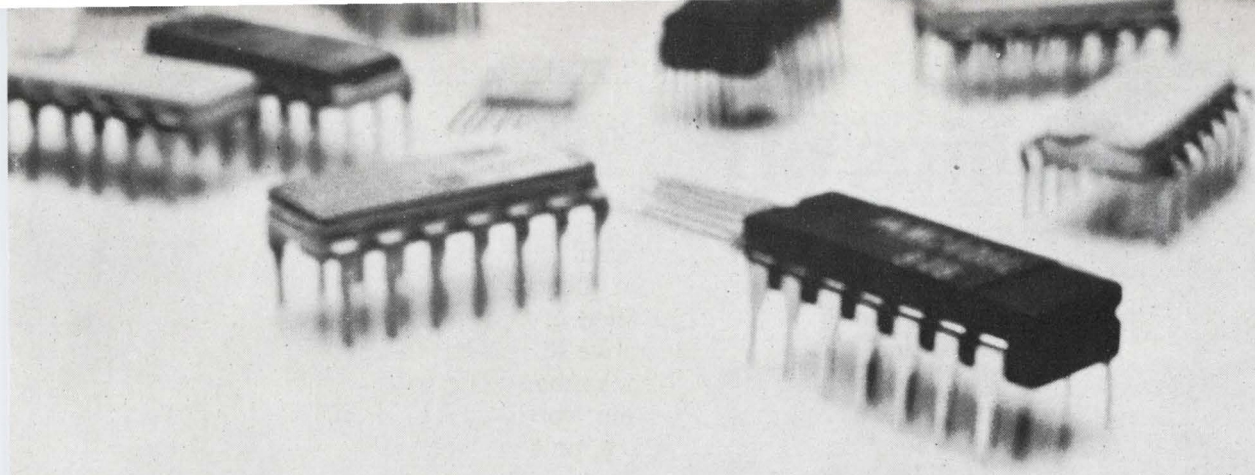

Our arrays aren't proud. They'll talk to any TTL family.

To most DTL families, too.

Because Sylvania functional arrays are designed to be compatible.

They use the same 5-volt power supply common to TTL circuitry. Their input-output levels are the same as SUHL I, SUHL II, 5400 and 7400N.

In short, you can use Sylvania functional arrays without interface problems.

And you get other advantages by using our arrays.

You get input/output buffering and the high noise immunity common to TTL circuitry.

You get the highest functional density at the lowest possible cost.

And you also get your choice from one of the largest lines of arrays available in the industry.

Sylvania functional arrays are avail-

able in military and commercial temperature ranges.

If you want to talk to TTL systems, talk to Sylvania first.

Sylvania Electronic Components, Semiconductor Division, Woburn, Massachusetts 01801.

SYLVANIA
GENERAL TELEPHONE & ELECTRONICS

Any chips off the new IC?

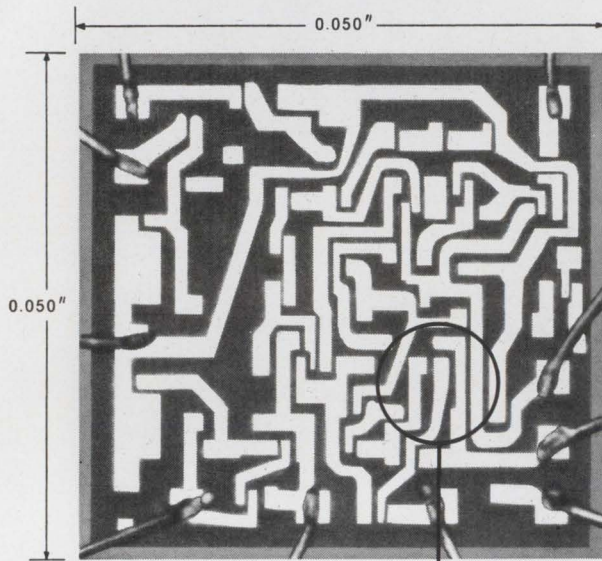

See the Surfalyzer at the IEEE show, March 23-26 • booths 25-35

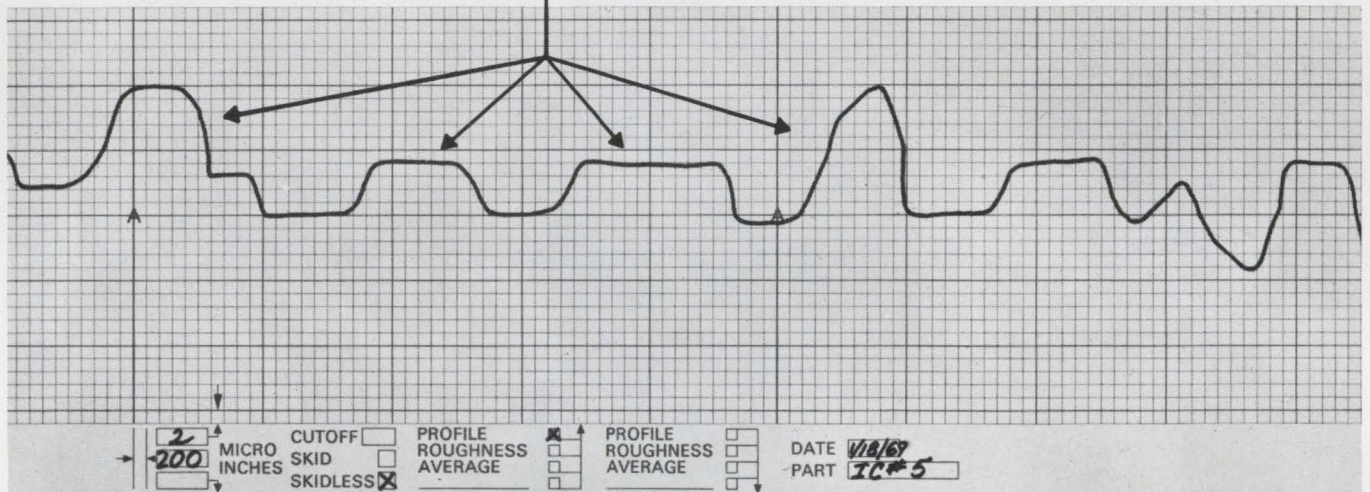

Non-destructive Clevite Surfalyzer tells you for sure. Shows deposit thickness, steps and true surface profile of a 0.050" diameter IC on a chart 3 feet long! And we haven't scratched the surface!

Never will either.

The stylus of the Surfalyzer adds the required light touch to surface measurement—glides across delicate circuit deposits at just 0.05 grams. Picks up the slightest imperfection . . . provides an undistorted view of the IC surface.

Note the extra-wide rectilinear channel. And the engineered chart paper that allows actual dimensional measurement of deposit on substrate. And the razor-sharp smudge-

proof trace. It's all part of our plan to provide IC manufacturers and suppliers with the most accurate, easy-to-read, easy-to-use surface recording system.

Have we done it? You be the judge. Write for complete details and the name of your nearest distributor. There's one close by waiting to demonstrate this extraordinary test equipment. Gaging and Control Division, Gould Inc., 4601 N. Arden Drive, El Monte, California 91731. Tel. (213) 442-7755.

Clevite Surfalyzer 150 Surface Measurement System

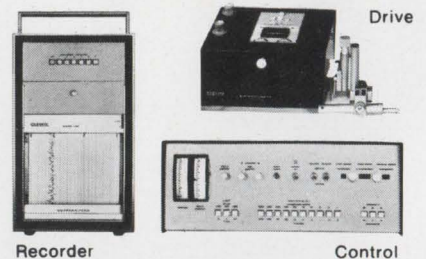

GOULD CLEVITE

Asking Mars the right questions.

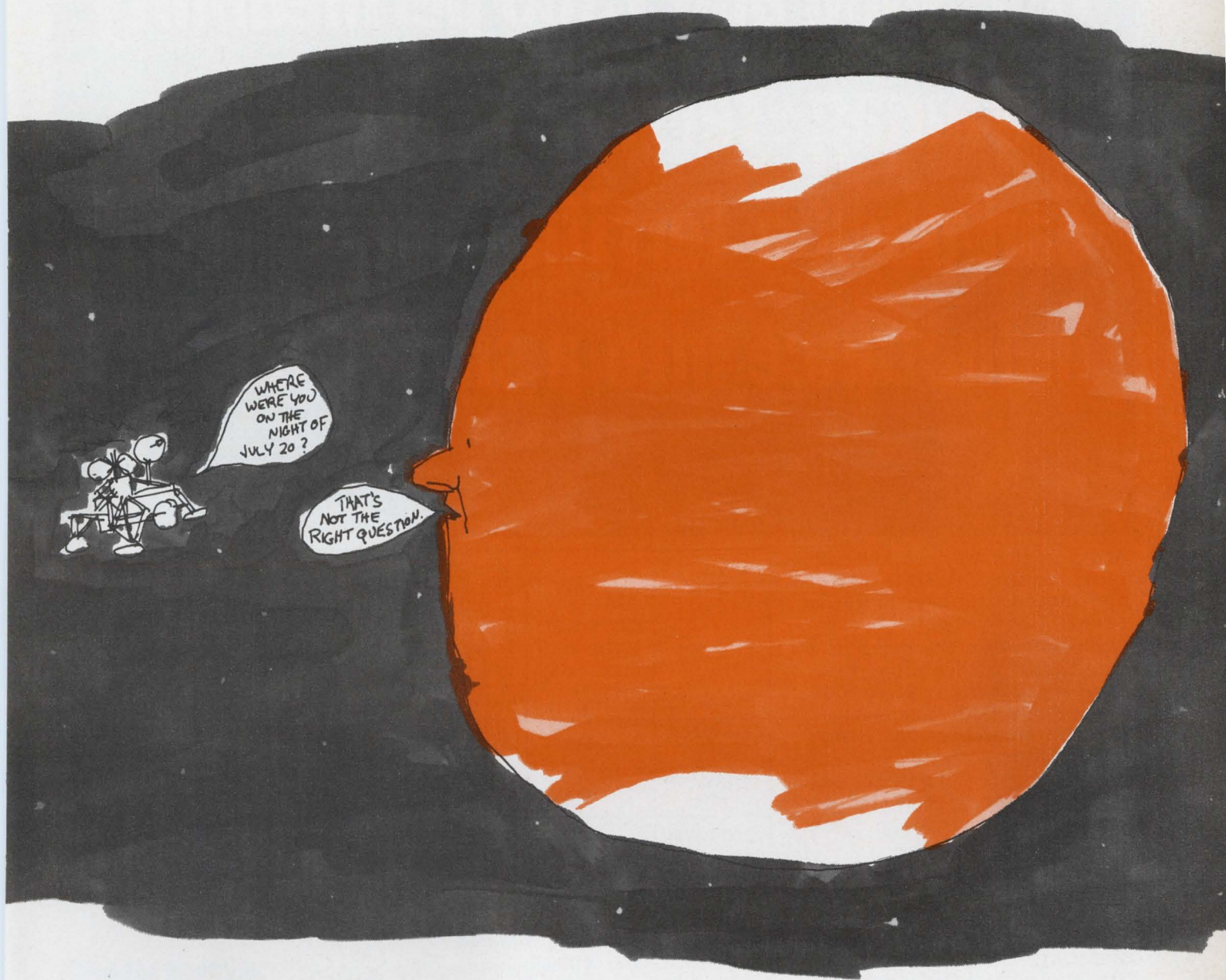

Our people are busy helping to plan and integrate the experiments Viking will carry to the surface of Mars in 1975. One of the knottiest problems is thinking up the right questions to ask the reticent red planet. The objective is to get the *maximum* amount of *pertinent* and *useful* information. Scientists, including ours, all over the nation are burning plenty of the midnight oil to achieve just that. Nobody wants to go 280-million miles and ask the wrong questions. *Martin Marietta Aerospace Group. Headquarters: Friendship International Airport, Maryland.*

MARTIN MARIETTA

Our 5000 and 7500 permeability Ceramag[®] ferrite materials can pack a terrific amount of inductance into a small size.

And the higher the perm, the fewer turns required. Results. Lower distributed capacity. Material savings. Improved performance.

Ceramag[®] offers the designer a true 5000 permeability. New, Ceramag[®] 24K is also a true 7500 permeability. Both materials hold their permeability over a wide range of sizes.

Ceramag[®] 24H and 24K are production materials, ready for immediate use in your design. Stock available in some sizes.

Precisely engineered, Stackpole ferrite materials are produced by exact processing, density checks, rigid kiln controls and accurate sintering. You get more out of Stackpole Ceramag[®] materials simply because we put more into them.

Study the characteristics of 24H

	$\frac{L}{N^2}$ (nh) TOROID SIZE: 0.230" O.D. 0.120" I.D. 0.060" L.	MAXIMUM PERMEABILITY	SATURATION FLUX DENSITY @ 1.5 OERSTED	RESIDUAL MAGNETISM	COERCIVE FORCE	CURIE POINT	TEMPERATURE COEFFICIENT OF μ_0	
							-25° to 25° C.	25° C. to 75° C.
CERAMAG [®] 24K	1485	9700	4100	700	0.05	175	+1.000	-0.450
CERAMAG [®] 24H	990	6900	3800	850	0.1	175	+0.700	-0.450
2500 PERM REFERENCE	495							

and 24K, then consider how you might use these ferrites.

For more information, samples and applications, contact:

Stackpole Carbon Company,
Electronic Components Division,
St. Marys, Pa. 15857 Ph: 814-834-1521. TWX: 510-693-4511.

Disaccommodation factor for both materials is 1.4×10^{-6} , typical.



STACKPOLE
Electronic Components Division

Producing high quality Ceramag[®] ferrite components for the home entertainment, industrial electronics and computer industries for over twenty-two years.



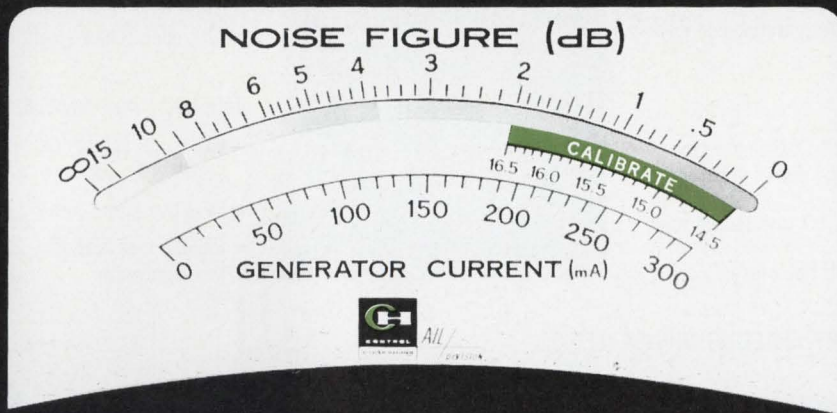

This expanded scale means unmatched accuracy and resolution on ALL's Type 75 Precision Automatic Noise Figure Indicator.



ALL's Type-75 provides automatic noise figure indication from 0 to 33 dB in the RF range from 10MHz to 40 GHz. Price less cabinet: \$1500.

Check our meter scale. You won't find another one like it on an automatic noise figure indicator.

Its expanded readout provides accuracy to ± 0.15 dB, with a resolution of a few hundredths of a dB over the critical lower half of the meter range. And a unique range switch puts any noise figure reading within this expanded portion of the scale.

It's a fact. No other automatic noise figure indicator even approaches this accuracy and resolution.

And here's another exclusive and time-saving feature: only with the Type 75 PANFI can you calibrate to the exact excess noise ratio of the noise generator being used. This means direct indication of actual noise figure without use of correction curves.

Exclusive solid-state design. Unique front-panel light that confirms a sufficient signal level for proper operation. Manual and remote control, too.

All of these features make the Type 75 the only automatic noise figure indicator really suitable for measuring the low-noise receivers of today and tomorrow. See for yourself. Call our "hot line" now to arrange for a demonstration. Just dial 516-595-3216 during East Coast business hours. Or



write for our full line catalog of Microwave Instruments, including the Type 75 Precision Automatic Noise Figure Indicator.

AIL a division of **CUTLER-HAMMER**



DEER PARK, LONG ISLAND, NEW YORK 11729

SILICON PHOTODIODES

Types 663, 671

- Large-area 5 and 10 mm diameter detectors
- High sensitivity, low capacitance, fast response
- Guard-ring structure assures low leakage current and low noise
- 10 ns response time, .3 to 1.1 micron sensitivity
- Suited for 1.06 μ radiation detection
- Hermetically sealed packages. Also available in monolithic four quadrant arrays.

Type 622 (3.0 ns response time)

- Totally depleted PIN structure
- Response time, 3.0 ns; sensitivity, 0.5 amp/watt
- High reverse breakdown voltage allows high optical background operation
- Available in 1 mm diameter or 1.7 mm square sensitive area
- Packaged in TO-46 housing with flat window

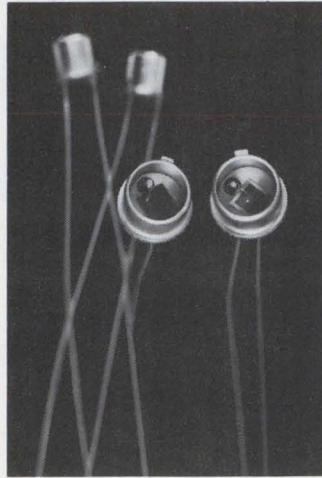

Special Photodiode Products

- Enhanced blue response photodiodes with greater than 90% quantum efficiency at 4000A
- High density mosaic photodiodes with active area arranged in binary form
- Staggered 2-line arrays with 0.003 x 0.003 inch areas, 0.006 inch center-to-center, completely integrated with operational amplifiers

Detector-Op Amp (Model 682)

- Low-noise silicon detector with hybrid operational amp in TO-5 package
- Sensitive area 2 mm x 2 mm
- Typical peak response 2.5 x 10⁴ volts/watt with 400 KHz bandwidth

VISIBLE AND INFRARED LIGHT EMITTING DIODES (LEDs)

GaP

- Designed to emit in the green region of visible spectrum (5600A) coincidental with peak response wavelength of the human eye
- Desirable for visual display and optical film writing
- Packaged in glass diode (DO-7) or molded epoxy lens (TO-18)

GaAs

- Designed to complement the high density application phototransistor line
- 0.9 micron emission matches peak silicon response
- Package selection provides highly directional or divergent output beams
- Also available for military or space applications

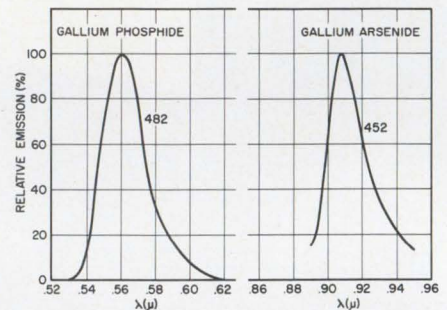

PHOTOTRANSISTORS

The industry's most complete phototransistor line designed to economically and flexibly fill most industrial and commercial optoelectronic sensing applications from single units to high density uses. Models 916L and W offer maximum sensitivity in hermetically sealed can with lens.

Molded epoxy encapsulated units give lowest cost for high volume applications.

Flat window units with wide field of view accommodate fiber optics interfacing. All devices are silicon, npn, planar, high gain phototransistors.

Applications in industrial control, intrusion detection, punched card or tape readers, position sensors, industrial counting, photo choppers, and shaft encoders.

Optically Coupled Isolators (Model 3N 903)

- Specially combined high gain phototransistor and GaAs LED
- Provides signal transfer where electrical isolation is necessary
- Current transfer ratio typically greater than 1.0 due to high sensitivity and efficient optical coupling
- Packaged in single-ended 4-lead TO-18 housing

ENL Offers a Complete Line of Photosensors and LEDs

Complete product literature and price information on request.

Also available: Germanium, Indium Antimonide, Indium Arsenide infrared detectors to provide response to 7 μ .



ELECTRO-NUCLEAR LABORATORIES, INC.

SUBSIDIARY OF INFRARED INDUSTRIES

115 Independence Drive, Menlo Park, Calif. 94025 • Phone (415) 322-8451

how to pick the right automatic measurement system when you have 14 choices

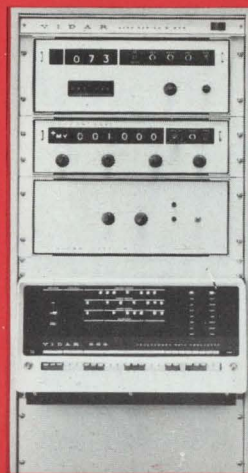
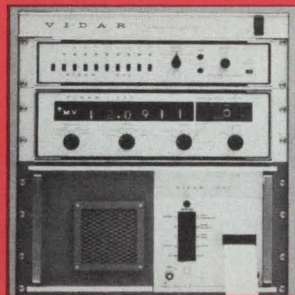

Automatic measurement with a VIDAR digital data acquisition system can make a dramatic difference in your operation. You can record data more precisely, in computer-compatible form. You can speed up data acquisition/reduction, so that the information you need is instantly available during and at the end of the test. You can reduce your data-handling costs and get a rapid payout on your instrumentation investment.

But *which* digital acquisition system should you consider when VIDAR gives you all these choices? Among the features of the fourteen standard systems are:

Automatic measurements: Vidar systems measure 1 to 1,000 data points . . . resistances from 1 milliohm to 12 megohms . . . frequencies from 10 to 2,000,000 Hz . . . 5 to 1,000 AC volts, and 5 microvolts to 300 volts DC.

Output: You get visual numerical display *and* a permanent record — on printed tape, punched tape, magnetic tape, Teletype, punched card . . . or processor-controlled with built-in mini-computer for real-time reports, and test or process control from basic physical measurements.

Scanning modes: Single scan, continuous scan, manual, single-channel monitor, or remote random access.

Interfaces: Any BCD output from shaft encoders, counters, other digital voltmeters, digital clocks.

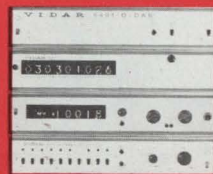

It's easy to select an automatic measurement system. That's the time to call in a VIDAR instrumentation engineer: he will help you select the best system, with off-the-shelf delivery. The system he helps you select is sure to save valuable engineering time and help you to improve your products or processes. Call or write today.

VIDAR[®]

77 Ortega Avenue, Mountain View, California 94040 (415) 961-1000

Circle 85 on reader service card

the automatic measurement people

Why NIXIE[®] tubes when we just developed SELF-SCAN[™] panel displays?

Now from Burroughs - two great digital readouts, NIXIE tubes and SELF-SCAN panel displays form a bright new team in digital readouts.

NIXIE tubes are your only logical choice for digital readouts containing up to 8 digits. Their long life, uniform brightness (200 ft. lamberts with no chance of partial fadeout) and the wide choice of configurations available help make NIXIE tubes the most economical, reliable, and readable digital readouts on the market for most panel displays.

BUT

When your display requires 8 to 10 or more digits, turn to Burroughs' amazing new SELF-SCAN panel displays.

Designed for larger displays, SELF-SCAN panel displays reduce drive circuitry up to 90%, thereby eliminating a major cost of readout systems. And

you can specify SELF-SCAN panel display systems with or without memory. Flicker-free, comfortably readable in the brightest light or darkest shadows, SELF-SCAN panel displays provide unparalleled savings for readouts with 8 to 400 digits of alphanumeric display.

Regardless of your readout requirements, one of Burroughs team of digital displays - industry standard NIXIE tubes or the outstanding state-of-the-art advance, SELF-SCAN panel display systems - will meet your needs.

For additional information write to Burroughs Corporation, Electronic Components Division, P.O. Box 1226, Plainfield, N.J. 07061. Tel: (201) 757-3400.

It's a matter of

DOLLARS AND DIGITS



More than 8 digits? Choose the new Burroughs SELF-SCAN panel display.



For 8 digits or less, NIXIE tubes are still your most profitable answer for readout displays.

See Us at IEEE Booth #2D39-45.

Circle 86 on reader service card

Burroughs



Technical Articles

**A new boss
cuts a new groove
at RCA
page 88**



Robert Sarnoff, RCA Corp.'s new chief, has embarked on more substantive changes after discarding the venerable Radio Corp. of America corporate title. Among these are a reorganization and an extensive realignment of priorities, with emphasis on communications and computers, and greater harmony among scientists and corporate marketing strategists. Clearly, the pioneering era of David Sarnoff has ended, but his son Robert has ambitious plans for a new era of his own.

**Backward step
opens up road
to new markets
page 108**

One step backward can mean two steps forward—especially at Ferroxcube, where a multidiscipline design team built an advanced memory that swapped speed for drastically reduced costs. The result: a dramatic opening to new industrial markets for core memories.

**Product planning
at the IEEE Show
page 112**

Product planning—judging a product's market and relating customer needs to a company's capabilities—is becoming more and more important. *Electronics* offers six examples of product planning—six new products to be introduced at the IEEE Show later this month.

**Dot matrix display
features inherent
scanning ability
page 120**

Familiar, to say the least, with the glow-discharge tube, Burroughs Corp. has adapted it to a multicell dot-matrix alphanumeric array. Burroughs' new display uses glow-transfer and glow-priming effects to provide automatic scanning with only a minimum of costly external circuitry.

**Strobing is key
to longer LED
alphanumeric display
page 126**

Another alphanumeric display design, this time using light-emitting diodes, reduces external circuitry through strobing. Hewlett-Packard's strobing drives the diode array one column or one row at a time instead of all together, so that costly IC functions can be shared by all characters.

**Segmented array
simplifies external
address circuitry
page 132**

Yet another display approach is the seven-segment light-emitting diode array. Though limited to numerics, Monsanto's display offers simplicity and economy—only seven elements must be driven, instead of the 27 or 35 in a dot matrix.

Coming

**Optic communicator
uses pulse position
modulation technique**

Laser communications usually brings to mind large, fixed systems with very large bandwidth capabilities. Now there's a laser communicator that handles just a single, two-way voice channel. Small enough to fit on a hat, it offers secure, high-quality transmission.



A new boss cuts a new groove

An era ended when the reins passed from father to son; now Robert Sarnoff is diversifying and assembling a strong marketing team to seek out new customers for RCA's new thrust—computers and communications



at RCA

By Roger Kenneth Field
Electronics staff

Color photographs by the author

● Perhaps the real founder of the Radio Corp. of America was an acting Secretary of the Navy named Franklin Delano Roosevelt, who decided that international wireless telegraphy was too important to leave in the hands of a foreign-based company. With that decision, British-owned Marconi Wireless Telegraph Co. of America in 1919 became the Radio Corp. of America, which was owned by a U.S. trio comprised of General Electric, Westinghouse, and a silent partner—AT&T.

RCA's original *raison d'être* was to run the wireless telegraph outposts it inherited, but within a couple of years the company plunged into radio broadcasting, and then became the exclusive merchandising agency for radio sets and vacuum tubes made by GE and Westinghouse. Under the pressure of a consent decree, GE and Westinghouse divested themselves of their holdings in the company (AT&T had been forced to do so several years earlier), and RCA began manufacturing its own merchandise.

Now, with sales of more than \$3 billion and over 12,000 products, RCA again is in transition. The first clues were the change in the corporation's name—from Radio Corp. of America to RCA Corp.—and the demise of Nipper, the fox terrier who listened to "his master's voice" with one ear cocked to the horn of a talking machine. But beyond these, RCA has changed its internal organization, its overall emphasis and direction for future growth, and its pattern of acquisitions.

Under the new plan, RCA is basically organized into five operating groups: broadcasting, consumer electronics and components, defense and commercial systems, information systems, and services, which includes such diverse endeavors as Hertz, Random House, RCA Institute, Global Communications, and a recently acquired frozen food operation, the F.M. Stamper Co. The shift is most pronounced in the movement away from the defense sector, which has slipped from 30% to 15% of RCA's sales, and toward information systems and services, which are high-priority areas for the 1970's. To maintain its traditional strength in consumer electronics, RCA is counting on its holographic video playback system; to bolster its position in components, the corporate marketing effort is being brought closer to the labs.

The man behind this new strategy is Robert Sarnoff, son of RCA's long-time leader, David Sarnoff. Four years ago he became president of RCA; two years ago, chief executive officer; recently, at 52, chairman of the board. Save the perpetual Sarnoff cigar, Robert shares with his father but a single trait: an almost reverential respect for meticulous, logical analysis, which both inherit from Grandfather Sarnoff who passed an ascetic life as a Talmudic student.

Robert Sarnoff quickly came to the conclusion that RCA must get as good at marketing as it is at technology. He believes RCA must start producing things that people can not only use, but also pay for: "We've got to stop looking for users, and start looking for customers," he asserts.

Sarnoff realized that a company the size of RCA could not get along without either marketing or planning staffs at the corporate level. His father had been a kind of one-man marketing and planning section, but that, clearly, was not Robert's *modus operandi*. So he set out to find someone to develop a strong marketing operation.

Sarnoff alerted his staff to look for well-qualified candidates and, after a time, he was introduced to Chase Morse Jr., a man who insiders say is likely to become RCA's next president. Morse, a former Ford executive, had been semi-retired, running an automobile dealership in Scottsdale, Ariz. He had no special expertise in electronics or communications. And he had come to New York not to seek employment, but to visit his mother.

But Sarnoff found Morse's experience extremely attractive. "He had been working in various responsible marketing positions at the Ford Motor Co. for 16 years, prior to running his dealership," says Sarnoff, "and he was a key member of the executive team that introduced the Thunderbird and the Mustang. Morse had experience with distributor relations from both sides of the fence—as a Ford executive and as a dealer—and, as you can imagine, that experience would be extremely valuable at RCA. So I took him up here on the mountain and let him look around."

Morse liked what he saw—so much so, in fact, that he started work on New Year's Day, 1968. He is modest about his new responsibilities: "Some people think all those guys are working for me," he says, "but I don't look at it that way. I just act as coordinator for everything that doesn't report to Bob."

With Morse aboard and corporate planning and marketing teams assembled, RCA now is in a position to implement Sarnoff's overall strategy for profitable growth. This strategy calls for:

- ▶ Acquiring smaller firms that are either highly profitable or likely to grow, preferably both, like Hertz.
- ▶ Integrating vertically wherever possible. For example, in Memphis RCA is set up to manufacture tv and f-m antennas it once purchased from outside suppliers and sold through dealers to the public.
- ▶ Striving for a commanding position in information systems, with special emphasis on data processing and interactive computing. Hence RCA's recent emphasis on its "octoputer."
- ▶ Diversifying geographically, as well as functionally. That's why RCA set up new plants recently in Belgium, Taiwan, Mexico, Canada, and Great Britain; dropped the word "America" from its name; stuck the word Global into what used to be RCA Communications Co.; and paid \$27 million for rights to run a telephone service in Alaska.
- ▶ Pruning away endeavors that show no signs of either profit or growth. RCA recently divested itself of its marine radio operations, its line of electron microscopes, and a medical electronics activity it started with Hoffman-LaRoche.
- ▶ Shifting emphasis away from areas that are shrinking or, at best, are not expanding as fast as the economy itself—defense, for example.

How do Morse and his team fit into this strategy? They are supposed to figure out what RCA should get into, and how.

The first big problem facing Morse and his men was whether the company should go to market with an untested and unannounced technique for holographically prerecording video signals on clear vinyl tape, or with Homefax, a system for broadcasting facsimile of printed matter that had been announced.

Morse's team opined that Homefax was still premature, but that the holographic video tape should be given a strong development push in the traditional RCA

style. Morse believes this market research on what later was announced as "SelectaVision" and is now called the VPS program (for Video Playback System) was valuable, and he calls it the first clear example of the company's systematic, formal approach to making corporate decisions of this kind. But the effort didn't end with the go-ahead. "Once we decided to go with prerecorded video tapes," says Morse, "we built a fence around it. We did a tremendous amount of in-depth interviews out in the field, and that's costly. But when we analyzed all the data, we knew what we were shooting for—and we also knew there was no consumer market for a system (a reference to CBS's EVR) that had a \$700 adapter, and tapes costing from \$20 to \$30 an hour."

Morse and his team determined what price people would be willing to pay for the adapter (\$400), what they would pay for the tapes (\$10), the size and shape of the adapter, and what kind of program to put on the tape.

VPS is only part of RCA's major thrust for the future—a thrust that goes beyond RCA's traditional emphasis on consumer electronics. "Now we are poised for the decade of information," says Sarnoff, who believes that information systems, especially data processing, will be as important to RCA in the 1970's as was color tv in the '60's, monochrome tv in the '50's, defense in the '40's, radio in the '30's, and wireless in the '20's.

To accomplish this, RCA hired away from IBM Ed

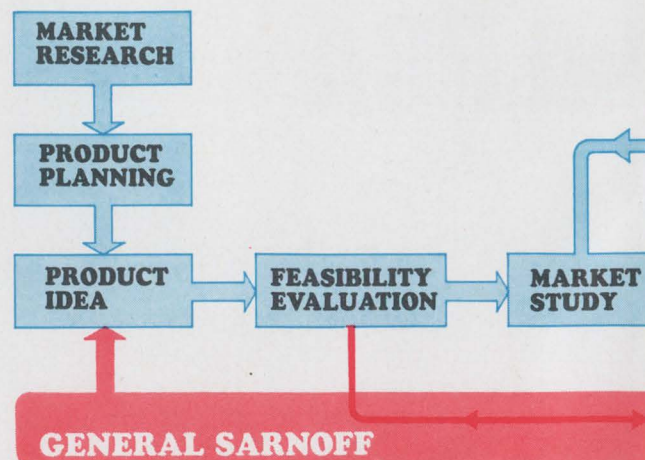

Visiting New York to see his mother, Chase Morsey Jr. ended up as RCA's executive vice president, operations staff. Insiders say he will become the company's president in January, 1972, when Robert Sarnoff is expected to relinquish one of his three titles. Meanwhile, Morsey is building a 40-man corporate marketing team and coordinating the president's policy committee, which meets once a month to evaluate new opportunities.

Donnegan, a marketing strategist who did the original analysis for IBM of time-sharing, then headed up that company's entry into the field. Now, as vice president and general manager of RCA's Computer Systems division, Donnegan has primary responsibility for fulfilling top management's mandate. "Mr. Sarnoff says he wants us to be a solid number two with 10% of the market by the mid-1970s, and we take that seriously," he says.

The goal is a bold one, and so is Donnegan's strategy for attaining it. "Most non-computer companies have tried to bite off some piece of the market that IBM has left uncovered," he says. "Honeywell, NCR and Univac have tried to take out small computers: SDS and CDC have concentrated on scientific computers. But RCA is going to hit IBM across the board. We're going for the middle spectrum of commercial computers—those leasing for \$10,000 to \$30,000 a month."

The ace up Donnegan's sleeve is RCA's expertise in communications, and the company's strongest effort is in remote computing. "In 1968, only 13% of all computers were communicating with remote terminals," Donnegan says, "but by 1975 we expect communicative computers to account for 50% of those installed." In 1968, 27% of the machines RCA installed were communicative, compared to 13% for the industry.

Basically, Donnegan's position might best be described as a front-row seat behind the eight ball. On

RCA's overall marketing strategy is essentially what other large corporations have been using for years. It eliminates, in essence, a number of "short circuits" used by General David Sarnoff to get technology to the marketplace.

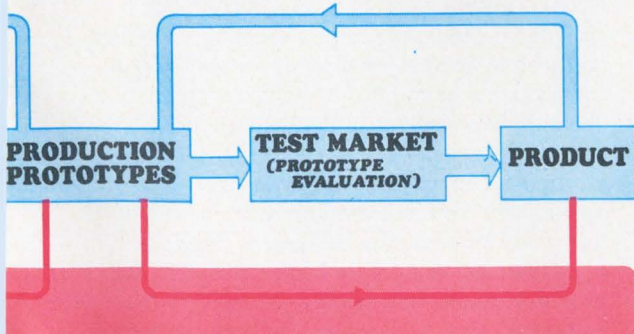



Marketing strategist Ed Donnegan reflects RCA's new aggressiveness in computers. Hired away from IBM, Donnegan heads up RCA's campaign to gather in 10% of the computer market—most of which will come from his former employer.



Trying to keep the tiger in the defense electronics group, Irving Kessler makes "tiger awards" to engineers who think up new defense markets for RCA's products. An award consists of a set of tiger cufflinks, a laminated paperweight with a stalking tiger captured in plastic, a bottle of Tigress perfume for the engineer's wife and, finally, a new suit from a local haberdasher. "Kind of corny," says one engineer, but he admits that the point—to encourage a marketing awareness among technical personnel—does come across. Along other corporate marketing lines, Kessler has instituted a great variety of marketing strategies designed to harvest the most desirable Federal contracts. For example, he keeps a running chart on the strategies of the defense group year by year with parallel entries for Pentagon moves. And he maintains what he calls "the Kessler kitty" to fund research in areas where the armed services may be likely to need expertise from its primary contractors. Groups of teams at each defense division sift through target contracts, pinpointing high-priority targets.

the one hand, he has a mandate to bring into RCA 10% of the computer action when no firm except IBM has yet managed to get and keep more than 7%. RCA is presently number five with 4%. Additionally, with over 70% of the market now in the hands of IBM, RCA is at the same point in sales that IBM had reached in 1951.

On the other hand, Donnegan recognized a tremendous opportunity when he came to RCA. He has the total support of Robert Sarnoff and Chase Morsey. The computer division already is building a strong base in remote computing. The technology, too, is working on RCA's side: with faster hardware, mostly due to increased use of high-speed monolithic circuits in 1970 models, Donnegan feels he can span nine IBM machines with only four or five Spectras. Then, too, there are a number of tactical advantages associated with the division's small size. IBM spent years educating computer users not to look at hardware alone, but rather to look at total service, a benefit that now accrues to RCA, since last year's consent decree required IBM to unbundle—to sell hardware and software separately. So RCA can walk into a ready-made market with total service. And the division's small size allows it to write flexible contracts that better suit the needs of small- and medium-size customers. "We have one contract," says Donnegan, "that allows the economy of outright purchase and the flexibility of lease. We lease the machine for 15% less than a similar one for IBM, and we let the customer keep it for nothing after six years. He pays the difference on a pro-rata basis if he wishes to bail out early, but we waive the penalty if he upgrades with RCA equipment."

Nor did IBM's increase in service costs, estimated at 10% to 12%, hurt RCA one bit. And finally, history may come full circle—in RCA's direction. If computers do move into the household, then home computers will be RCA's field the way office equipment was IBM's.

Donnegan, with a key sector of RCA's future resting on his shoulders, moves confidently ahead. He has assembled a product-planning team of 80 people, and this year he expects to hire 1,100 people from college campuses to train as systems analysts and programmers—roughly the same number IBM's recruiting campaign is expected to produce. "From 1950 to 1960, IBM was an exciting company that went from where our division is now to \$1 billion sales," says Donnegan. "I believe RCA

Computer Systems division will be just as exciting during the 1970's, and that it, too, will reach \$1 billion sales at the end of its decade."

Except for RCA's bold effort into computers, a plunge that is now costing the company about \$2 million a year in cash, the Sarnoff-Morsey marketing strategy is basically conservative—hardly the sort of stuff disasters are made of. But one element of daring is implicit in RCA's approach: RCA is gradually developing a dependence on widespread availability of wideband cable. Many projects and aspirations depend on the ultimate stringing together of homes and offices with coaxial cable on a scale comparable to that of the telephone.

For example, sophisticated remote computing that involves the manipulation of visual data requires wideband connection. So does efficient computer-to-computer communication. The company's plans for success in manufacturing cable tv equipment—at this point, and on any scale that RCA could view as successful—would require evolution of a huge cable network.

Indicative of RCA's anticipation of the ubiquitous coax is the work in progress at the David Sarnoff Research Center at Princeton. There, the cable has implications for three out of five major projects. The one that is most intimately tied to the cable is the development of a home information center. If that is to go beyond a slick collection of receivers and playback devices, it must be capable of passing audio and video signals in and out of the home.

The implicit dependence on cable points up a fundamental difference in corporate style between David and Robert Sarnoff. The former was a pioneer, who set sail on the electromagnetic spectrum with confidence only in his own capacities.

Robert Sarnoff is much more the modern corporate executive, confident of his industry, but understanding that how he and his company fare is at least partially subject to the caprices of the economy and other circumstances over which he has little or no control. In such a context, corporate growth and profit must be pursued in an entirely different way.

Ironically, many elements of the new thrust at RCA bear a striking resemblance to the condition of the company's birth. Global communication, for example, was precisely the reason that caused the Navy Department to create RCA. The desire for vertical integration had its origin back in the Twenties, when RCA engineers weren't satisfied with the vacuum tubes made by General Electric's Lamp division. Finally, even the recent marketing decision to go ahead with VPS had predecessor in the conceptual framework of the Radio Corp. of America. As one RCA old-timer puts it: "The modern analog to David Sarnoff's radio-phonograph of 1922 will appear in 1972 as the television-holograph."

What is truly new at RCA is not so much the goals as their respective emphasis and the corporate style with which they are to be attained. This new emphasis was perhaps best captured by one recent moment in Robert Sarnoff's office. He was trying to recall the names of the operating groups that report directly to him, and he easily rattled off information systems, NBC, services, and defense—in that order. But he rubbed his chin and looked toward the ceiling as he tried to recall the last one: "I know there are five," he said . . . "Oh, consumer electronics and components."

To market, to market is RCA labs' new motto

● The David Sarnoff Research Center in Princeton, N.J., unquestionably has fashioned many successes for its namesake. But paradoxically, the General's reverence and admiration for men whose technical education surpassed his own night-school engineering degree were largely responsible for some missed opportunities, too. For by leaving the scientists largely on their own Sarnoff also left the technological side without the crucial market guidance that was needed to get ideas out of the laboratory and on to the sales charts.

In the relationship that developed between the General and his scientists, he drove them to produce commercial systems he believed would have tremendous impact on society—for example, easily-tuned radio, television and color television, and the video tape recorder. Thus the lab primarily attracted scientists who hankered to hitch their wagons to such undertakings. "The guys here don't get their kicks by determining the magnetic moment of the electron to 13 significant places," says one scientist who has spent many years at the lab.

"Although it was nice to be left to our own judgment, we were kind of lonely," says Bill Webster, now vice president of RCA Laboratories. "And in our loneliness, many of us tried to figure out what technology would be marketable, and we proceeded to try and develop it."

It's understandable that scientists would take such an attitude. Requests for guidance could well be answered

with "shopping lists" of tedious short-range problems. However, the entrepreneurial initiative of the Princeton scientists that blossomed forth to fill the void was blunted in two ways:

▶ Scientists who worked long hours on enjoyable ideas felt frustrated when headquarters couldn't market the results.

▶ On the other hand, a number of marketable ideas developed by the lab weren't picked up by headquarters simply because they didn't fit in especially well with corporate goals.

Energy conversion fell into the former category. Aware of the growing need for electrical power, scientists at the lab got fired up about basic research and developmental work on batteries, thermoelectric devices and solar cells. They successfully developed several devices, including self-healing solar cells, a 500-watt thermionic tube, and advanced thermocouples made of a germanium-silicon alloy. But headquarters believed RCA could not compete with battery manufacturers like Union Carbide.

The most striking example of a demonstrably marketable technology opportunity overlooked was RCA's early effort in computers. An RCA scientist, Jan Rajchman, working in parallel with a group from MIT, invented the core memory and made a working prototype by Christmas of 1949, then tried to get a corporate division to

1

Researchers in Princeton, N.J., were long on freedom but short on guidance from corporate headquarters; hence, technology and markets didn't always meet

pursue it. "They told me at Camden that a million cores would saturate the entire U.S. market, so production wouldn't pay," says Rajchman, smiling. "Now, one big machine uses a million cores."

A number of firms did jump in and were making cores by 1952. In 1956, RCA finally opened a plant to make them at Needham, Mass., but by then the company was limited to specializing in high-temperature cores.

RCA's first opportunity to get into computer manufacturing came in 1942 when the Army Ordnance Department offered the company the ENIAC program to build the first all-electronic computer. Headquarters turned it down because the project didn't seem to have commercial potential. But in the end, RCA scientists, including Rajchman, cooperated on the program, which ended up at the Moore School of Engineering. There, the men from Princeton, with several years of experience in digital gun controls, found themselves the reigning experts.

Another opportunity knocked right after the war when

2 Now, applications-oriented scientists like Jim Hillier and Bill Webster are in charge



IBM approached RCA to collaborate on a line of electronic computers for office use. The idea was that RCA would supply the electronic expertise; IBM, the knowledge of business machines. But RCA turned that down, too, and IBM had to go it alone—with great success.

To be sure, there was a case for avoiding the office-machine field at the time. As one scientist at the lab says: "In retrospect, we can see that it was easier for IBM to learn electronics than for RCA to understand business machines." A Xerox executive, observing that both RCA and Kodak turned down the Carlson process that later became Xerography, puts it this way: "Kodak put its money in Kodachrome; RCA went into color television. Who's to say those were bad decisions?"

No case, however, can be made for RCA's myopia in electronic components—an area in which the lab always excelled, and with which the corporation is thoroughly familiar, both as manufacturer and user. Yet in components, marketing misjudgments have become such a

regular occurrence that RCA has even developed a strategy to handle it. It's called the "venture-big-capital-and-leapfrog-the-technology" method.

Technological leapfrogging salvages a late start. With prices dropping rapidly in an established technology area, competing against those already strongly entrenched doesn't pay. So the alternative is to anticipate the next area to which the industry will flock, and carve out a leadership position there.

There are two tricks to successful leapfrogging. First, you have to guess the direction of technology and contribute viable innovation. Second, you have to hustle goods to the marketplace, maintaining as much of a lead as you can, to insure that you are still the leader when the rest of the pack comes panting along.

But there are plenty of pitfalls. You can leapfrog into an innovative area that simply doesn't yield marketable products, while the rest of the industry slowly pushes on in conservative, but fruitful endeavors. You can come up with developments that your corporation isn't in a position to sell. Or you can come up with marketable developments so sophisticated that corporate executives simply can't grasp their importance, and the ideas die on the vine.

At RCA labs, in the past, almost every possible combination of these mishaps occurred. They came to haunt the company's reaction to the one postwar development

3 Lab research is coordinated with marketing goals... and the scientists love it

that most seriously affected its position in components: the transistor.

The company's first reaction to the Bell Labs development was that the feeble amplification of the current-driven device could never compete with the then well-refined vacuum tube. Later, as transistors proved useful for amplifying small signals, RCA, convinced that semiconductors could never handle power levels and voltages needed to drive loudspeakers and cathode-ray tubes, kept mapping out areas for tube design that semiconductors were least likely to encroach upon. Belatedly, the company got into the production of germanium transistors, but by that time the semiconductor houses had started looking toward silicon devices, since its easily oxidized surface facilitated passivation.

When silicon was quite clearly established RCA leapt-frogged into gallium arsenide, which has a higher electron mobility than either silicon or germanium and seemed destined to succeed them as the industry sought transistors with higher and higher performance. For years, scientists at Princeton struggled to make superior transistors with gallium arsenide, but a marketable bipolar device never emerged.

In 1963, two young scientists fresh out of college, Fred Heiman and Steve Hofstein, invented the metal oxide semiconductor. Although the device offered small size and high input impedance, MOS didn't fit into RCA's semiconductor outlook at the time. The Heiman-Hofstein transistor was fabricated on silicon, not gallium arsenide. And its analog characteristics were worse than bipolar devices, not better. So RCA didn't put it into production. Later, after a number of firms started making and selling MOS transistors and arrays, RCA attempted the bizarre maneuver of trying to leapfrog a technology that had been created right in its own laboratories. The company staked out a market in complementary MOS arrays, which contain both n- and p-channel MOS transistors on a single silicon chip. This market has grown to \$1 million compared to the present \$35 million market for p-channel MOS arrays.

Meanwhile, the company realized that gallium arsenide probably would never be able to compete with silicon for bipolar transistors and arrays. Fortunately, however, before the lab dropped its efforts, scientists determined that the virtues of materials made up of the III-V compounds, like gallium arsenide, relate to their bulk properties, not to surface effects or to transistor action at junctions near the surface. So now Princeton has a jump on most industrial laboratories in bulk-effect semiconductors like injection lasers, Gunn-effect devices, and electroluminescent diodes.

The new RCA corporate marketing approach is intended to take much of the guesswork out of innovations that come out of the Labs. But Chase Morsey Jr., executive vice president, operations staff, has no intention of forcing scientists to devise products for which his staff believes a market exists. "What we hope to do," he says, "is to move research closer to marketing in two ways. First, we will make decisions at headquarters that will help implement faster the development programs in the labs. And second, we hope that our own market research efforts will turn up missing things that users would like to have. I believe marketing has an obligation to transmit the needs of the people to scientists." Will such mild encouragement suffice to supplant the

General's direction for important crusades, and to improve on his record? Robert Sarnoff believes this is entirely appropriate: "I'm a great believer in environment," he says.

What do the scientists at the labs think of this approach from headquarters? Not surprisingly, they love it. Many of them already have met some of Morsey's 40-odd marketing men, whom they find bright, enthusiastic, and interested. Says one scientist: "What's happening at the labs is nothing more than what should have been happening all along. The company has taken an approach to product planning and marketing similar to that of many other companies of comparable size. I feel the change was long overdue both as a researcher and as a shareholder. I just wish RCA would stop declaring a dividend and plow all its profits into the new strategy. Then you would see this place take off!"

Another puts his finger on the new mechanism that RCA hopes to exploit: "Look at it this way. SelectaVision came about not because a guy was playing around with holograms, but rather because some guy was looking at new products that were needed—keeping in mind the pool of available technology—and he found a match."

What follows is some of today's technology at the David Sarnoff Research Center, and its creators—the scientists who are looking for those "matches" that will build RCA's future.

Ed Ramberg is making a match simply by being at the Sarnoff Research Center. The shy, diligent scientist with a Ph.D. in physics from the University of Munich joined RCA as a junior engineer in 1935. Since then, his interest in electron optics earned him an enviable reputation in development of both television and electron microscopy. In recent years Ramberg has been working on coherent optics, specifically sources of noise in holograms. This is a convenient endeavor when a major company goal is to remove noise from its VPS (Video Playback System, formerly SelectaVision) which depends for both sound and images on a series of holographs embossed on a strip of thin, clear vinyl. With Ramberg behind them, scientists working on the VPS project have started to isolate and eliminate holographic noise, and three sources have been identified: a multiple beam interaction; dirt on optics; and a moire pattern, that originated when a master tape failed to align as it passed through a pair of pressure rollers.

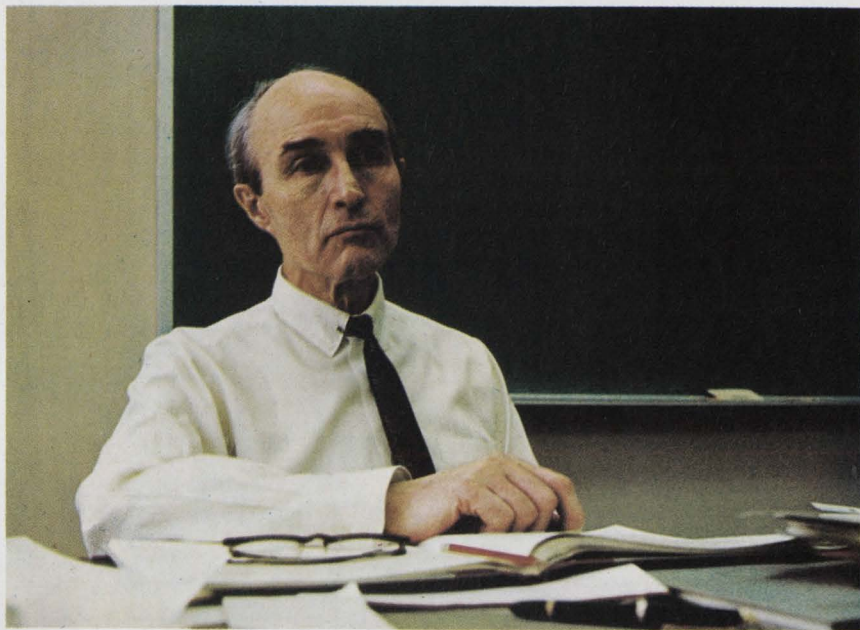

A new breed of scientist comes to RCA: Matchmaker

By pairing technology
with future product needs,
RCA seeks perfect matches

Paul Weimer is matching thin-film technology to the problem of making a cheap, tiny vidicon that may someday change the entire nature of broadcast journalism. The sought-after development is a thin-film vidicon on a wafer. Weimer and his colleagues already have made an image-sensing array of 256 by 256 elements and installed it in a tv camera a little bigger than a cigarette package. Now Weimer is shooting for a 512-by-512 array, which he hopes will be ready by year-end. If Weimer is successful, tv news reporting could be freed from large crews and bulky equipment. But first Weimer must eliminate vertical streaks in array-produced images—a defect caused by nonuniformities in the light-sensing array and its scan circuitry—and show that working 512 by 512 arrays can be produced with reasonable yields. Then, RCA must figure out how to handle the roughly 8 million bits a second that will spew forth from the miniature camera.

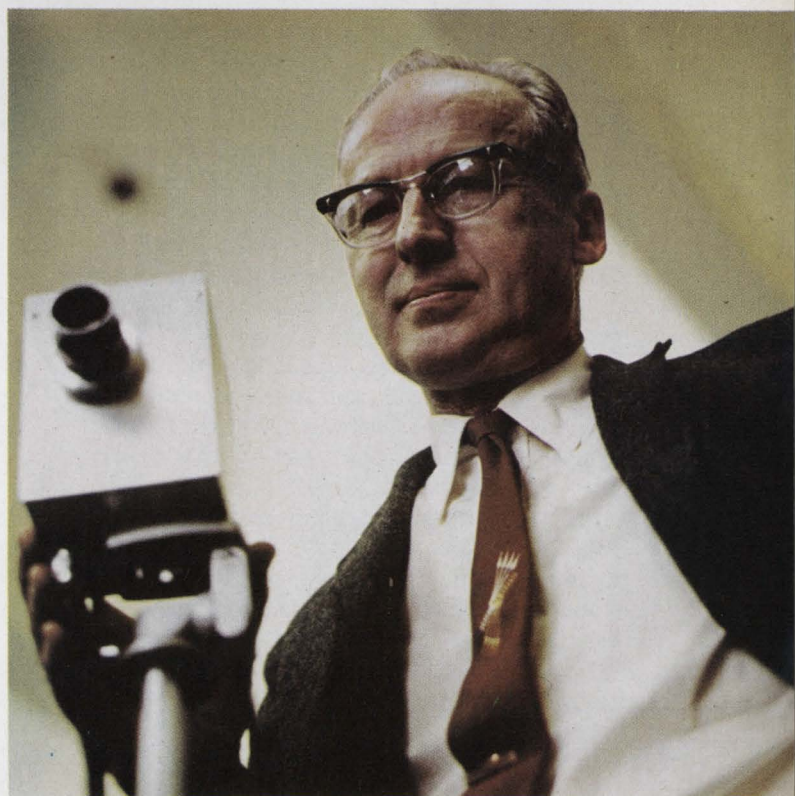

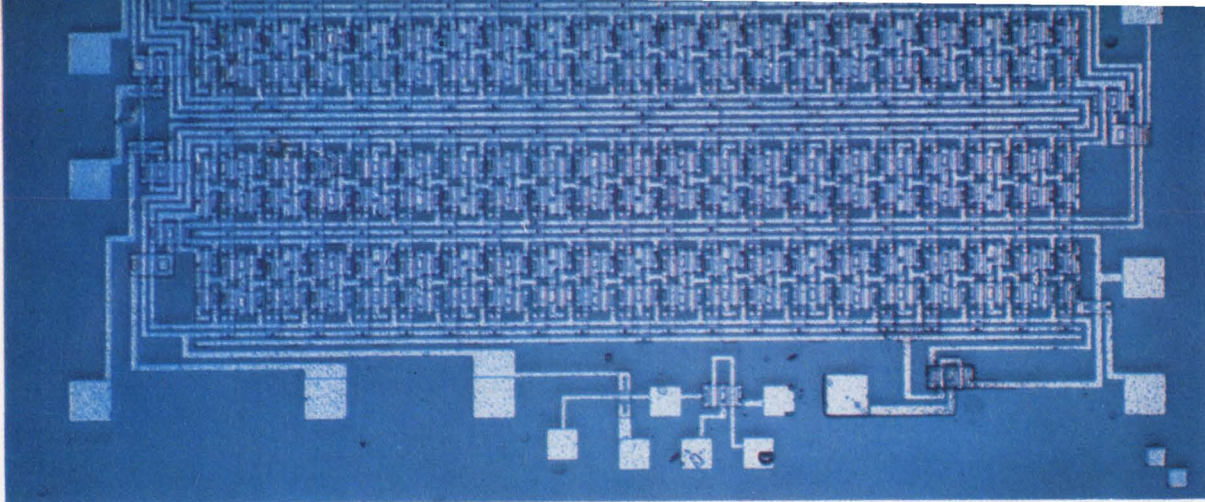

Joe Scott and Joe Burns have matched silicon to sapphire in order to outperform MOS arrays. The team predicts silicon-on-sapphire arrays of one-nanosecond gates. With both a 50-bit dynamic shift register operating at 100 Mhz (above) and a content-addressable 16-bit memory under their belts, Scott and Burns are ready to attempt a 256-bit random-access memory with full x and y decoding on a silicon-on-sapphire chip. The 110-mil chip will have 1,900 devices, 15 nsec access time and quiescent power consumption measured in microwatts. Scott and Burns are achieving surprising SOS specs and yield—better than 60% for the 80-mil, 50-bit shift register from wafer through testing and bonding. Still, they admit to disadvantages: silicon technology can't be transferred to SOS on a one-to-one basis; contaminants can't be dissipated into the substrate; and the doping is extremely light ("you almost can count the number of dopant atoms," says Burns). But the two have great faith in SOS—they believe it offers the speed of bipolar and complexity of MOS.

Jan Rajchman is making his sixth match by blending lasers into mass memory. He joined RCA in 1935 and unleashed a stream of developments that included the electron multiplier tube; the betatron, a particle accelerator he helped develop; the first read-only memory, which he fashioned from a resistor matrix in 1939 for an electronic gun control; the magnetic core memory, which he made first from permalloy and then from ferrite; and finally the transfluxor, a multi-holed ferrite device that serves as the key element in magnetic logic circuits. Now Rajchman is fired up over optical memories, and he and his colleagues are trying to develop one that will store 10 billion bits in a package no larger than a color tv console. The key to Rajchman's optical memory is a device he calls a "latrix," for light accessible transistor matrix, which must simultaneously control about 10^5 channels of information, interface with the computer's central processor, and detect the same number of light channels to facilitate readout of stored information. "Optical memories," says Rajchman, "could eliminate tapes, disks and cores in one fell swoop by offering advantages in cost per bit, density and speed. I'm personally convinced of 100% success—it's in the air! Even if this were somebody else's project, I'd give it at least a 50% chance of success."

Bernard Hershenov's group made a match by establishing a base of expertise in microwave integrated circuits at RCA, which prides itself on its technological strength in communications. As head of the "Blue-Chip" program, Hershenov steered his people to develop designs for an S-band amplifier, an i-f amplifier (1 to 10 gigahertz), and a circulator. To do this, the Blue-Chip group had to put the tiny signals through their paces. For example, an amplifier (shown) required a high-power transistor, so the group rose to the occasion with a Schottky-barrier junction FET in gallium arsenide—source-to-gate

and gate-to-drain gaps measured about half a micron—and the device put out 5.6 watts with a 6.5-decibel gain at 2.2 Ghz. The group's present goal is a 60-Ghz transmitter and receiver, each on a chip, for secure communications between satellites or at extremely close range. To do that, Hershenov expects to use a distributed Gunn-effect device, laid down as a thin epitaxial layer of gallium arsenide. "We've already run a 20-Ghz feasibility test," says Hershenov, "and we expect to come up with a device that'll put out 50 to 100 milliwatts in the 60-Ghz frequency range."

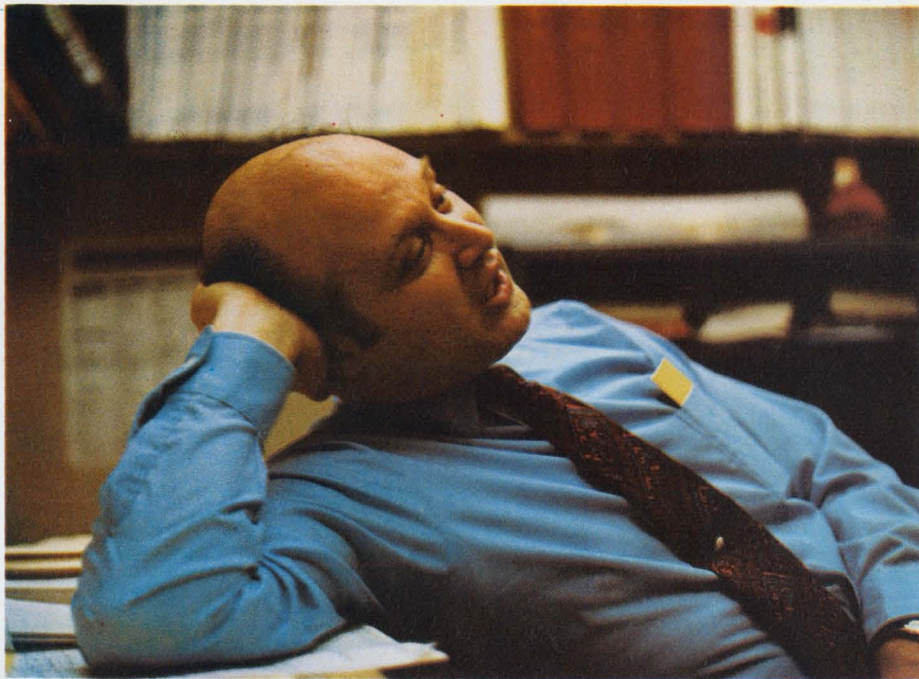



Henry Kressel made a match by using dislocation-free alloys of gallium arsenide—fabricated through a “vapor-phase growth” technique developed at the labs—in constructing injection laser diodes. These lasers, with their special doping, are especially handy because they lase at room temperature in a “close-confinement” mode that Kressel pioneered. The scientist now stores the semiconductor laser and other spontaneous diodes in rows of little drawers in his office, but he believes that mass production and widespread use are not far away. “Where infinite life, compactness, efficiency, compatibility with IC’s or low power consumption are important,” says Kressel, “spontaneous diodes are a cute, novel way to do things with light.” Now, for example, they are used in card readers, obstacle detectors, bomb fuses, and light-triggering of silicon-controlled rectifiers, he says. In the future, applications could include short-range communications, rangefinders, panel lights, holograms, and intrusion alarms.



George Heilmeier has made a match by blending his knowledge of chemistry with an investigation of relatively weak electric fields in nematic liquid crystals. By doing so, he produced a liquid crystal that exhibits “dynamic scattering”—the otherwise clear liquid turns milky when an electric field of a few volts is applied, causing a movement of ions that disrupt the liquid’s ordered molecules. The liquid returns to a clear state upon removal of the small voltage. This effect could be useful for displays or it could make its mark simply as an optical shutter. Just how liquid crystal will eventually be applied is uncertain, but switching in most cases is fast enough to qualify for use in flat-screen tv, displays for instruments that operate in bright light, and optical memories. All that’s needed to see the effect clearly is a pair of parallel plates separated by about 1/1000 of an inch and filled with the liquid crystal; a pattern of tin oxide deposited on the two inside surfaces; and a small battery. Connect the latter to the two oxide patterns and presto!



Nipper belonged to London artist Francis Barraud, whose painting was so popularized on Victor records that he spent his life painting copies. RCA recently kicked the dog out of everything except its Red Seal recording albums

The highly personal corporate style of David Sarnoff



● When the Radio Corp. of America, inherited the assets of the Marconi Wireless Telegraph Co. of America, it found among them what turned out to be its all-time most valuable asset—the unselfish, unassailable, and unyielding devotion of one David Sarnoff, commercial manager.

Sarnoff often has been heralded as a genius or a visionary. But one thing is certain: he was a man for his time, with mental capabilities flawlessly matched to the pursuits he chose.

His greatest asset by far was an uncanny ability to isolate and identify human wants. His capacity to make a decision and stick to it pulled him through a period of turmoil when weaker men fell by the wayside. And, his showmanship helped him stake out a claim in a field in which showmanship counts heavily.

Sarnoff's insight into people's wants was evident at an early age and, in the earliest days of radio, this sense was to steer him into a major success. Dr. Alfred Goldsmith, then a professor of electrical engineering at City College, invited Sarnoff and RCA's sales engineer to his downtown home for dinner. The purpose was to show the visitors a simple radio that Goldsmith had installed to pick up music from the transmitter at a nearby Wanamaker Department Store.

"At that time," says Goldsmith, "radio nuts kept a kind of scorecard each day of how many distant stations they could hear. The engineer with David was obviously in that league, and he went on and on about how my set was no fun because you couldn't twiddle lots of knobs and reach distant stations. And he insisted that nobody would buy a radio that could pick up only local stations when there were already several sets on the market that could do better than that. David just sat there, then he finally turned to him and said, 'Will you shut up. I'm thinking!' Then he turned to me and said, 'Alfred, this is the radio music box I have been dreaming about for years.'" Soon after, the Radiola 4 was introduced and became an immediate success. Tuning was done with one knob that set capacitors in the LC and antenna circuits.

Perhaps the most striking example of the Sarnoff insight was his plunge into television. Most entrepreneurs with Sarnoff's success in radio would have fought anything—like television—that appeared to threaten their position. On the contrary, David Sarnoff

A 1921 tourist group at RCA's wireless station at New Brunswick, N.J. included (front, left to right) host David Sarnoff, E.J. Berg, Albert Einstein, Charles Steinmetz. The tall man (extreme right rear) is Alfred Goldsmith, a founder of the IRE and a lab chief and consultant to RCA for over 50 years. He holds many patents, including one on the tri-phosphor color tv picture tube presently in use.



Modest, to say the least, was the first RCA lab (1920) which was pitched in a field at Riverhead, L.I.

not only refrained from any such fight, but he picked up the new technology when it seemed about to expire and brought it back to life. The rescue occurred when Vladimir Zworykin, a scientist at Westinghouse, found himself without a job after his company lost confidence in the commercial possibilities of television. But Sarnoff took Zworykin aboard and told him to get started.

Sarnoff's subsequent commitment to television points up another quality of the man—his ability to make decisions and then stick with them, for years if necessary. In that sense, Sarnoff was unshakeable.

His determination didn't always bring joy, even to those within RCA. Color tv is a good example, for not everyone at RCA was convinced that it was anything more than a meaningless embellishment of black-and-white tv, and some were dragging their feet in development. But Sarnoff had made up his mind, and he was determined to see it through. He called a meeting in his office and asked the principal figures involved in the color project how long he could expect to wait for demonstration of a working color tv system. Reportedly, after cursory analysis they opined that such a demonstration would require three to five years. "Come back here in three months with a working, electronic color tv system," said Sarnoff. "And if you don't have it, don't bother coming back at all."

Sarnoff's decisions had their human side, too. In fact,

he tried to be as kind as a highly competitive industry in turbulent times would allow. When one RCA employee showed unusual skill in handling some especially intricate matters with the Federal Government, Sarnoff discovered it and asked for complete details, which were assembled and supplied quickly. Upon reading the report, Sarnoff summoned the man and told him that he was completely familiar with what he had done. "I called you here because I wanted to tell you personally that your action on behalf of this company will not be forgotten," Sarnoff said. "I am pleased to tell you that no matter what the future brings, your continued employment is assured as long as you live."

And David Sarnoff never went back on his word. Decades later, the man was given notice along with other employees in his group. When word of this lay-off reached Sarnoff, he quickly reinstated the employee.

Sarnoff learned to appreciate the value of showmanship only when his well-developed skills for verbal combat didn't carry him far enough. One such occasion was a private meeting in the mid-Twenties with several executives from the Victor Talking Machine Co, who came to New York at Sarnoff's request to witness the demonstration of an electrically amplified phonograph. The unit sported a radically different magnetic pickup, instead of the mechanical type then in use.

The trio from Victor included the company's resident musician, Walter Clark, whose critical ear was responsible for talent selection. They brought with them two identical copies of a Victor record to use in the comparison of the new electrically powered and amplified RCA machine with a standard Victrola. "The difference was like that between a Rolls-Royce and a kiddy car," says Goldsmith, who by this time headed up the RCA lab at Van Cortlandt Park that spawned the new phonograph. "The three people from Victor discussed the matter, while David and I stood by confident that laurels were about to descend upon our heads. Nothing of the kind ensued. The Victor executives said flatly that our machine was no good. 'Why?' David asked. We were absolutely astonished when they said: 'Victor would have absolutely no use for your machine. It doesn't sound like a phonograph.'"

Sarnoff never forgot the lesson he learned from the Victor people. From that day on, all demonstrations of new technology were carried out on his terms, and he absolutely insisted on flawless command performances. For his demonstration of color tv before the FCC many years later, for example, he had Nanette Fabray in a colorful miniskirt sing "That's what makes Paris, Paree." "Nobody noticed the details of color," says Goldsmith. "Miss Fabray really sold the system for us and David knew that."

But during David Sarnoff's reign at RCA, perhaps his most important attribute was his ability to pick the brains of brilliant men, but never take any of them as gospel. He carefully weighed the advice of all who offered or were asked—be they greats or near-greats in technology—and in the end made up his own mind. The process took time and involved phenomenal concentration. But he almost invariably turned up the right conclusion—the right conclusion for RCA at the time.

With Brig. Gen. David Sarnoff's retirement, an era ended—an era of problems and promises that were largely conquered and fulfilled. ●



"Birth of an Industry" was the title of a speech given by David Sarnoff at the 1939 New York World's Fair. The speech was the first news event televised by a broadcasting company. In it, Sarnoff made the bold prediction that television would someday become "an important industry."

lev-er-wheel

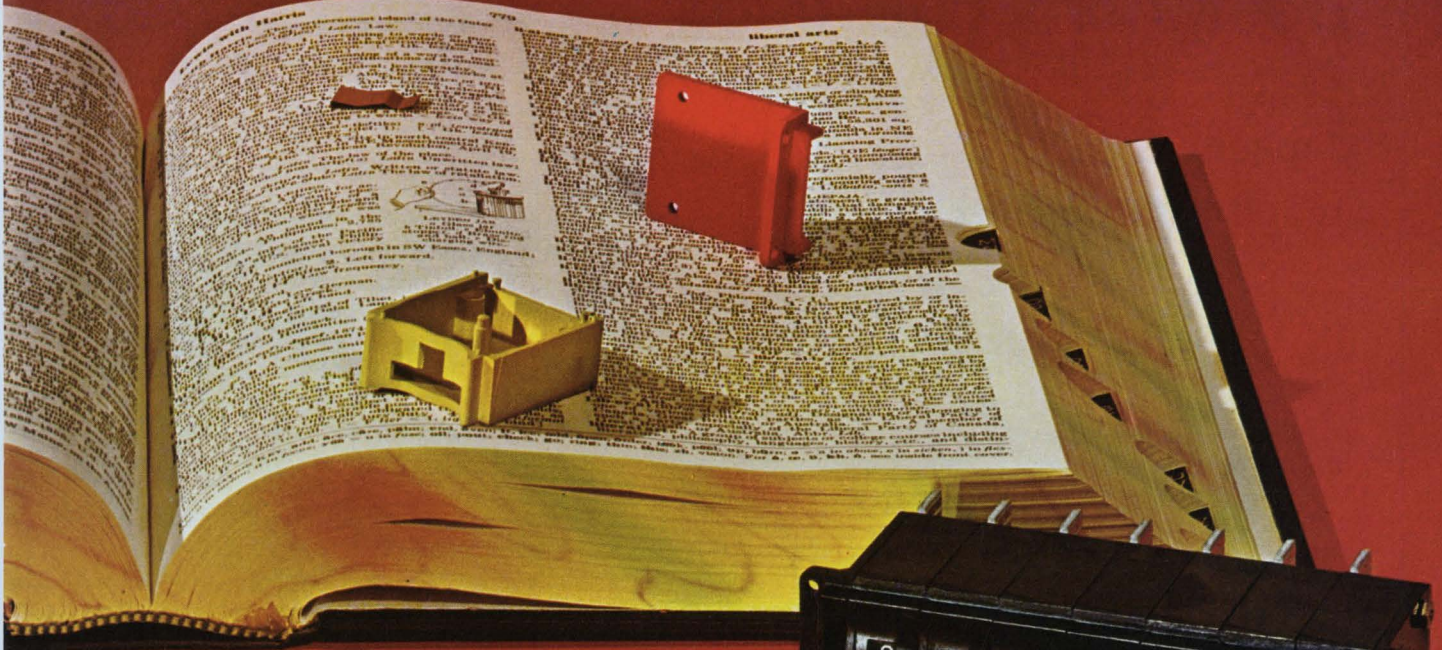

... so new
you can't look it up
in your Funk & Wagnalls

LEVERWHEEL SWITCH ... a brand new concept ... Thumbwheel Lever-Action by CHERRY

FASTER SETTING: A single movement of the Leverwheel setting lever through its 60° arc is all that's necessary for a complete 10-Position cycle. (Compare *that* to plunking through the 360° rotation on conventional thumbwheel!!)

Instant reset at no extra cost: A simple sweep with the hand and all levers return to home position with every switch in the bank returned to "zero."

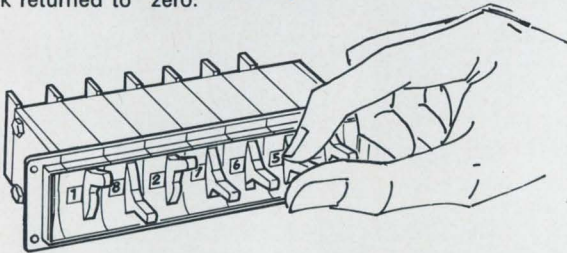

Cherry has new standard thumbwheel switches, too! Like the unique new Leverwheel, Cherry thumbwheel switches are available in miniature and subminiature sizes, totally-interchangeable with other leading thumbwheels.

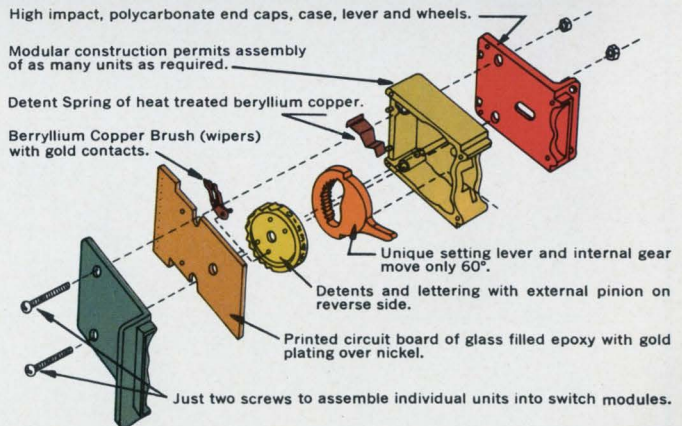

See Cherry New Products at
IEEE Show Booth 4C20

CHERRY

CHERRY ELECTRICAL PRODUCTS CORPORATION • 1656 Old Deerfield Road, Highland Park, Illinois 60035
Circle 103 on reader service card

Designer's casebook

Designer's casebook is a regular feature in Electronics. Readers are invited to submit novel circuit ideas and unusual solutions to design problems. Descriptions should be clear. We'll pay \$50 for each item published.

Capacitors add up in voltage multiplier

By H.R. Mallory

Mallory Battery Co., Tarrytown, N. Y.

By charging several capacitors in parallel and then discharging them in series, an output capacitor can be charged to essentially a multiple of the supply voltage. The circuit is useful in building transformerless d-c to d-c converters, where any number of stages can be added to produce a desired voltage ratio. Using a transformer may require custom-tailoring for a special turns ratio.

The circuit produces an output voltage almost triple the supply voltage. Transistor Q_2 , which is part of a free-running multivibrator, switches off and on at a frequency determined by the component values of the multivibrator. When Q_2 is off, the three 0.1-microfarad capacitors charge to the supply voltage less the forward drop of the diodes through the 1-kilohm resistors and the

diodes. Transistors Q_3 and Q_4 also remain off—they are reverse-biased by the diodes' forward voltage drops.

On the next half-cycle of the multivibrator, Q_2 turns on, and the capacitors forward-bias Q_3 and Q_4 into conduction. The capacitors are connected in series-aiding as their charge is transferred through diode D_4 to the 120- μ f output capacitor. The voltage to which an unloaded output capacitor charges is about three times the supply voltage minus the voltage drops of diodes D_1 through D_4 , and the saturated voltage drops of transistors Q_2 through Q_4 .

Diode D_4 prevents the output capacitor's charge from leaking when transistor Q_4 is off and the last multiplier capacitor again is charging to the supply voltage.

By referencing the output capacitor voltage to the positive side of the supply line, an extra stage of multiplication is gained. A multivibrator frequency of 1,350 hertz was used to provide 31 or 43 volts across the 120- μ f capacitor. With a different number of multiplication stages, other multiples of the supply voltage will be obtained. And the circuit can be tailored to operate at other supply voltages as well as at different switching frequencies.

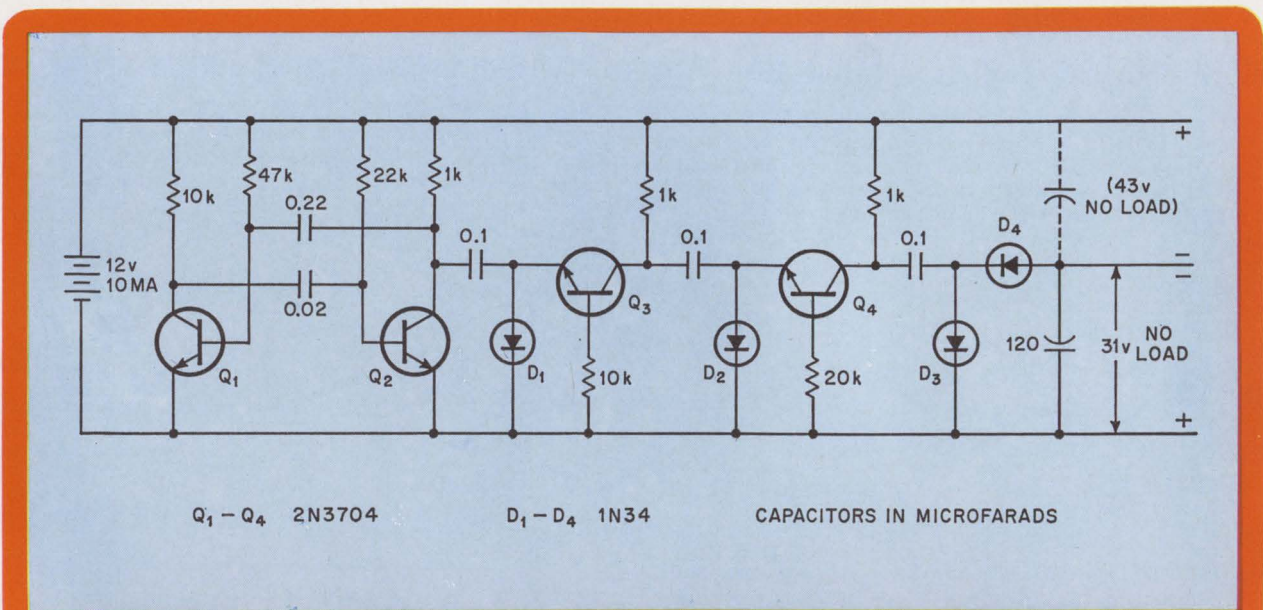

Series-aiding. When transistor Q_2 is off, the three 0.1-microfarad capacitors charge to the supply voltage. On the next multivibrator cycle, Q_2 turns on, also turning on transistors Q_3 and Q_4 . The three capacitors, now in series, unload their charge on the 120- μ f output capacitor which charges to triple the supply voltage.

A staircase and a ramp yield multiple sawtooths

By Eric G. Breeze

Fairchild Semiconductor, Mountain View, Calif.

Sawtooth waveforms are used for character generators in cathode-ray tube displays and for sweep circuits in oscilloscopes. Several waveforms generated in synchronism and occurring sequentially can be made with a combined analog and digital circuit. The digital segment generates a staircase whose equal-amplitude steps are added algebraically to the ramps of a sawtooth generator—the analog portion. The sum adds up to a sawtooth whose period is the length of the staircase.

Many applications have to resort to motor-driven potentiometers to generate long, sequential sawtooths. However, these potentiometers are not always reliable. This circuit generates sawtooths with long periods (in seconds) where the amplitudes track over large temperature variations.

The circuit can be divided into four functional parts: a unijunction transistor sawtooth generator, a divide-by-three counter, a staircase generator, and a resistive summing network.

a divide-by-three flip-flop circuit, a transistor staircase generator, and a resistive summing network.

Transistor Q_1 acts as a constant-current source which linearly charges the capacitor C to the unijunction transistor Q_3 's firing voltage. Transistor Q_2 functions as a quick discharge path during the sawtooth's flyback time. The sawtooth generated at the unijunction's gate is transmitted to the resistor summing network through the emitter-follower, Q_4 , which provides a low output impedance.

When the unijunction fires, the divide-by-three counter, 9020, is clocked, and the decoded counter outputs sequentially switch on transistors Q_5 , Q_6 , and Q_7 of the staircase network. The transistors' load resistors are connected in series as three equal resistances. When any of the three switching transistors conduct, a different voltage is generated at each of the three resistor nodes. The voltages are 0 , $\frac{1}{3}$, and $\frac{2}{3}$ of the supply voltage, V_s .

By connecting the summing resistors with the transistor loads, sequential staircase waveforms are generated. And when the sawtooth is summed with the staircase, long sawtooths are generated with periods equal to the length of the staircase.

Only three sequential sawtooths are shown here, but the number can easily be extended through the same techniques. Transients occurring in the output due to switching can be easily filtered.

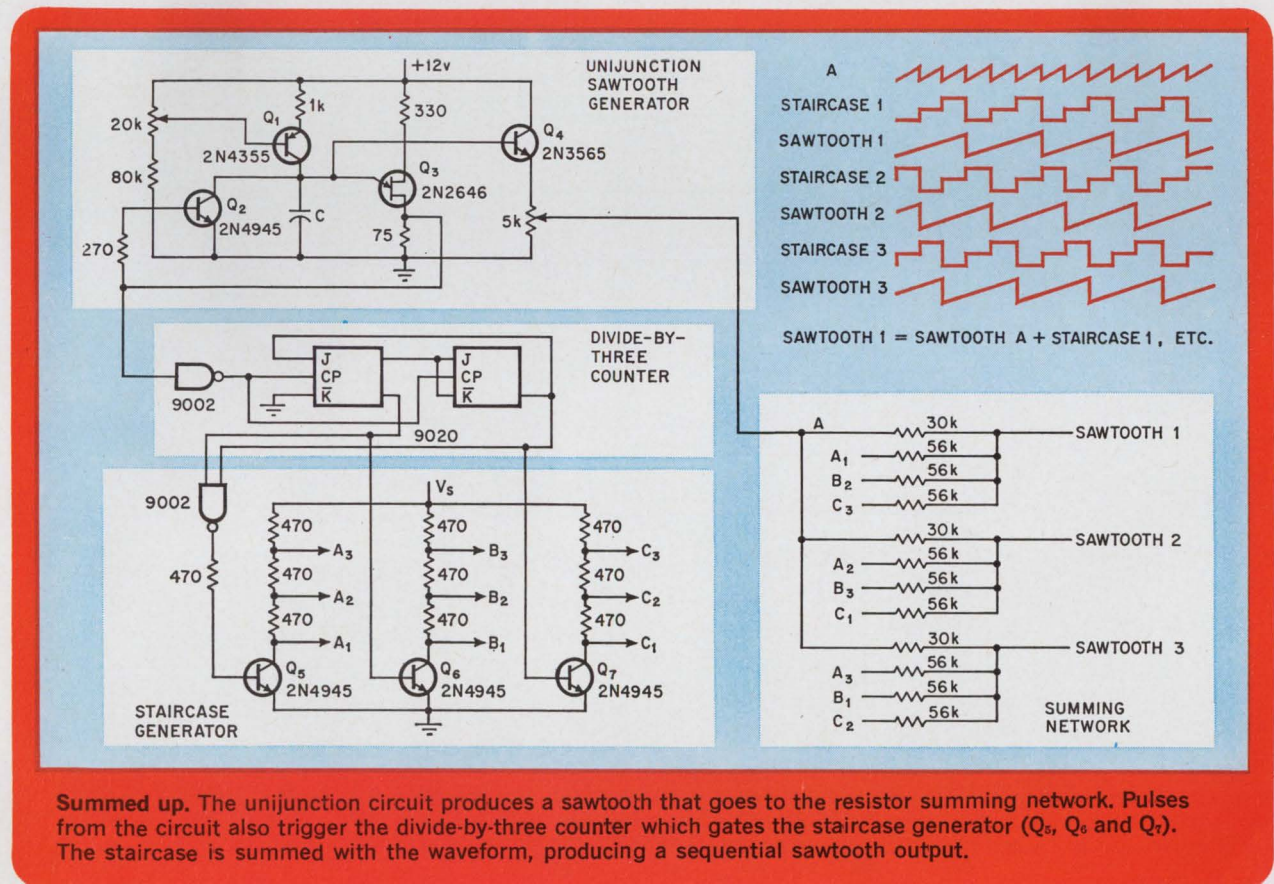

Summed up. The unijunction circuit produces a sawtooth that goes to the resistor summing network. Pulses from the circuit also trigger the divide-by-three counter which gates the staircase generator (Q_5 , Q_6 and Q_7). The staircase is summed with the waveform, producing a sequential sawtooth output.

Variable d-c input adjusts pulse width over wide range

By S. Nagarajan

Hindustan Aeronautics Limited, Hyderabad, India

A triangular-wave generator connected to one of the differential inputs of a comparator forms the basis for a simple pulse-width modulator. When a modulating signal is applied to the comparator's other input, the circuit will develop a train of output pulses with widths proportional to the amplitude of the modulating signal.

The simplest case uses a d-c voltage as the modulating signal. The mark-space ratio of the pulse train can be varied by varying the d-c input voltage.

The triangular wave is generated during the linear charging and discharging of capacitor C. The capacitor is shunted by transistor Q₂, which is turned on and off by an input square wave. When the transistor is off, the constant-current generator Q₁, charges the capacitor; when the switch is turned on, the capacitor discharges through Q₂. If the collector load of Q₂, which

establishes the discharge time constant, is properly chosen, the discharge can be made almost linear; the result will be a triangular wave. The emitter follower, Q₃, delivers the wave to one input of the comparator.

The magnitude of the control voltage or modulating signal is adjusted by the 10-kilohm potentiometer and is applied at the other input of the comparator. If the voltage set by the potentiometer at the base of Q₇ is less than the voltage generated by the triangular wave at Q₅'s base, current from the constant-current generator, Q₄, flows through Q₅ and Q₆, lowering Q₉'s base voltage relative to Q₁₀. Hence, Q₁₀ conducts while Q₉ remains off. The current flowing in the collector load of Q₁₀ causes Q₁₁ to saturate, producing a 12-volt output pulse for the time that the voltage of the triangular wave is greater than the d-c control signal.

When the triangular wave drops below the modulating signal, the reverse procedure occurs. Q₇ and Q₈ conduct, lowering the base voltage of Q₁₀, which shuts off while Q₉ conducts. With Q₁₀ off, Q₁₁ also is biased off, and the output across the 5.6-kilohm resistor drops to ground.

The circuit was designed to operate at a frequency of 100 hertz, but scaling the integrating capacitor's value will produce lower or higher frequencies.

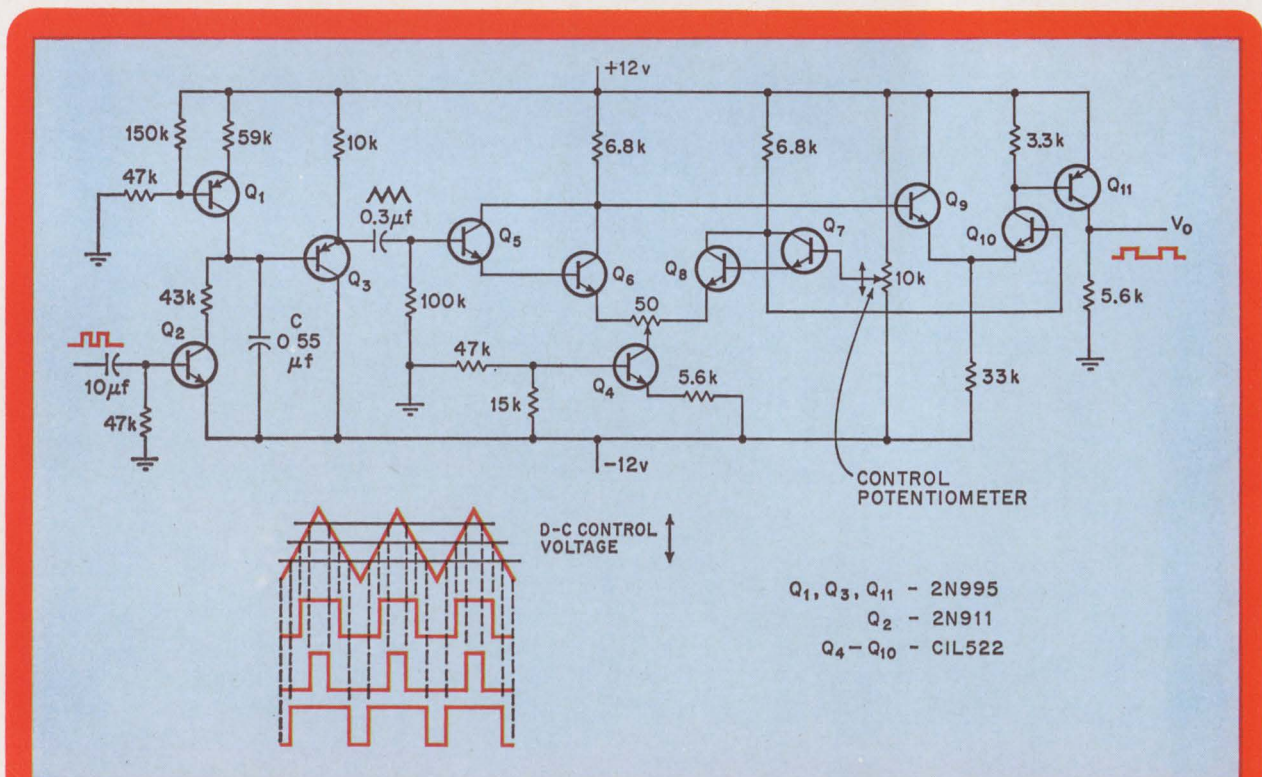

Modulator. A triangular waveform feeds one input of comparator Q₅-Q₈ while a d-c voltage adjusted by the 10-kilohm pot feeds the other. When the d-c voltage exceeds the triangular voltage, Q₁₀ and Q₁₁ are off and the output is 0 volts. When the reverse occurs, Q₁₀ and Q₁₁ conduct and the output rises to 12 volts.



we goofed.



This Howard Cyclohm Fan was engineered to run 10 years. So far it's been running 12 years, 6 months, 21 days.

Our modest 5-year guarantee on Cyclohm Fans and Blowers is based on an engineered lifespan of 10 years. So, what do we tell our customers when they report the fans are still blowing strong 12 or even 14 years after installation? We tell them we goofed—and they benefit.

There's more to the Howard Cyclohm Fans and

Blowers success story than just long life. There's the high reliability of Howard's unit bearing motor that never needs maintenance or re-lubrication. And all metal construction. Indestructible nylon blades. Standard mounting on 4-1/8" centers. UL yellow card listing. All units are off-the-shelf . . . available for immediate delivery from Standard Motor Product Sales. All the facts are in the newly-published, 14-page Cyclohm Fans and Blowers Catalog EL370 From Howard.



HOWARD

HOWARD INDUSTRIES
MSL INDUSTRIES, INC./MOTOR GROUP
2420 18th STREET, RACINE, WISCONSIN 53403
414-632-2731 TWX 910-271-2387

Backward step opens up route to new products and new markets

Product planning has some definite lessons to offer the industry, says Ferroxcube's *Jack Buckwalter*; by modifying core size to slow a memory and reduce cost, task force achieved mass production and wide sales appeal

● In their race for speed and miniaturization, manufacturers of computers and associated equipment often overlook a potentially vast market of commercial and industrial users. Caught in the backwash of the on-rushing state-of-the-art technology, these would-be users neither require nor can they afford highly sophisticated hardware. What they need are products planned specifically for their needs—both in performance and in price.

Such an approach was taken by the Ferroxcube Corp., a manufacturer of memories. In essence, Ferroxcube started by backing away from the leading edge of technology in developing a core memory. By sacrificing one feature—speed in this case—designers were able to develop new low-cost systems that are opening new markets. This approach permitted further cost reductions in manufacturing and synergistically came up with techniques for mass producing and marketing advanced technology products.

Ferroxcube's one step backward, two steps forward approach called for a multidiscipline redesign team to systematically question market, development, application, and manufacturing assumptions about memories. After three successive redesign efforts, the team came up with a magnetic-core memory that could be mass produced for only one-third the cost of the original computer-oriented memory.

A similar backward step can be profitable in a wide range of products—especially those sophisticated electronic products that currently are not widely accepted in industrial markets. A few obvious ones are tape transports that could be redesigned for applications requiring only low data rate and small physical volume; line printers for applications that overtax a strip printer, but don't need full page-printout capacity or speed; and alphanumeric displays.

The evolution of Ferroxcube's product line to fit fresh marketing objectives reflects the value of close cooperation among market research, product development, and manufacturing engineers. This cooperation spawned several valuable lessons:

- ▶ Product development must be a team effort, without rank, and the team must represent the views of customer, factory, and internal and external technology.
- ▶ Cost effectiveness is best achieved by a multiple-pass design, in which the team successively tests the fundamental premises, the fundamental techniques, and the evolved refinements. In memory redesign, these correspond respectively to the premise that slower speed will cost less, interboard wiring can be reduced, and the subassemblies of the finished product can be reorganized for lower cost.

The chief aim of the redesign was to bring down the cost per bit of storage in the memory devices that

FIRST PASS COST REDUCTION

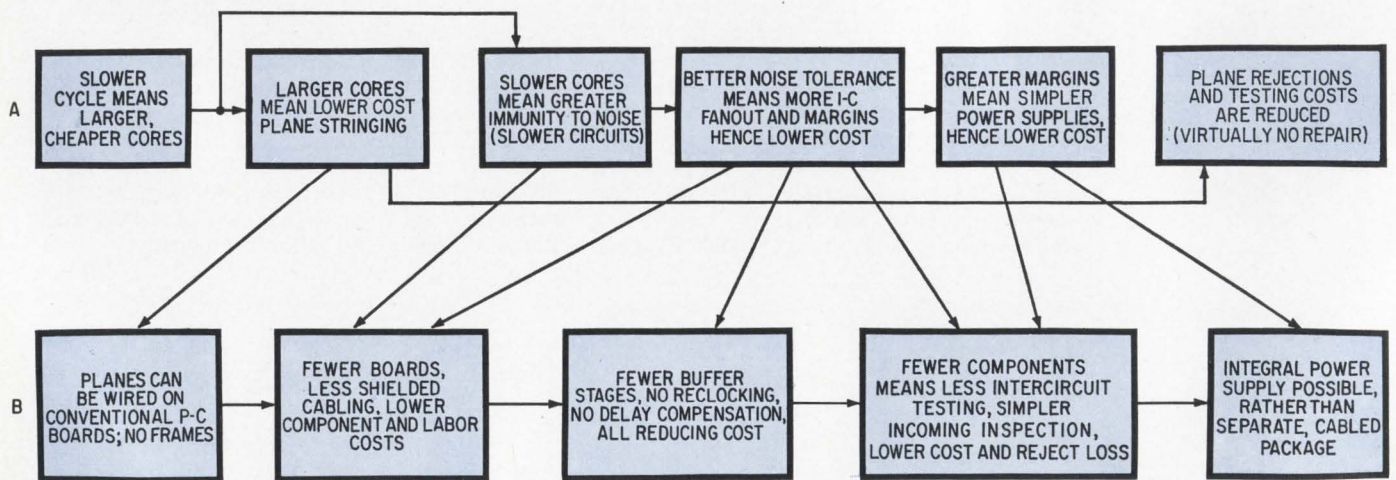

SECOND PASS COST REDUCTION

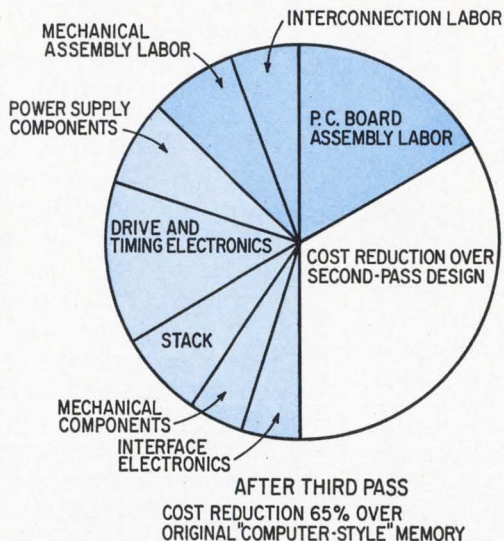
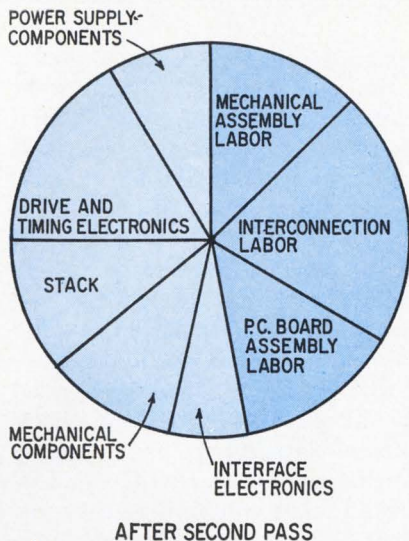

Third pass. Following the design and manufacturing cost reductions, new modules, which could be combined into memories of almost any size, were defined within this framework. They cut the two-pass cost by another third and the original cost of a fast memory by about two-thirds.

were offered to the noncomputer market at the time. The initial purchase price is the most persuasive factor to a designer when he selects components for industrial process controls, instrumentation, small business machines, and automated machinery. Sales to these designers never developed into the kind of market that memory manufacturers had hoped for. Designers continued to find enough reliability for their purposes in relays, crossbars, and other electromechanical memories.

Not even the electronic memories' vaunted qualities such as data volatility, nondissipative storage, data-handling versatility, and nondestructive readout could overcome a reluctance to pay more per bit and more per function. Designers also refused to be swayed by the fact that maintenance costs per bit over 5,000 hours for an electronic memory are negligible. Over the same period, the maintenance cost for an electromechanical memory, though considerable, still didn't bring its cost up to the level of electronic memories.

While these facts were generally known, their implications were not clear when the Ferroxcube team began its study in 1966. The study produced a fundamental set of observations:

- ▶ Computer-grade memory systems are always much faster than industrial and commercial users require.
- ▶ Faster memories cost more to build.
- ▶ Faster memories cost more to use, because, for

example, the system to which they are connected must have faster rise times and better noise immunity.

▶ Industrial and commercial users are generally not interested in memories with cycle times faster than about 2 to 10 microseconds. But, within that speed range, they would be interested in memories that were as easy to buy as conventional relays, crossbars or tape and card devices—provided the memories cost much less than the conventional devices.

In examining these initial observations, the task force, which comprised a marketing expert, an applications engineer, a digital circuit designer, and a manufacturing specialist, drew on its combined expertise. The group raised the question: Would the costs for slower memories—much slower, maybe 10 times slower than the standard 1 to 2 μsec designs that were then offered—actually be low enough to bring them into line with those of other storage devices?

To answer the question, the researchers first tested basic design assumptions. They selected a conventional 2- μsec computer memory, and tried redesigns that would cut cost without affecting reliability or function, with the exception of cycle times, which were allowed to be anything up to 20 μsec . Changing one parameter, such as increasing core size, gave a pyramid of economies, ranging from less expense for stringing the cores to fewer profit-robbing rejects. So, after the first

Two passes. In cutting the cost of a ferrite core memory, the first task was to simplify design, in the steps at top. This simple design then permitted cost reductions in manufacturing (bottom).

This is the 16th installment, and the 37th article, in *Electronics'* continuing series on memory technology, which began in the Oct. 28, 1968, issue.

A look over the shoulder

When the coincident-current magnetic-core memory was first produced commercially, about 15 years ago, the computer market was the only market for it.

About 10 years ago, independent core-memory manufacturers—that is, those who did not also build computers—were saying that the cost of core memories could be reduced only by developing mass markets other than the computer market. Everyone spoke bravely of the widespread potential use of core memories in industrial process systems, in small business machines, in numerical-controlled machines, in instrumentation and data-acquisition systems, in telemetry, and so on; but, no one manufacturer was able to develop and sustain a demand large enough to justify mass production.

About five years ago, a number of independent memory-system manufacturers introduced large catalogs of moderately priced memory systems, in which the sizes, performance characteristics and prices of hundreds or even thousands of models were given. But none of the units in their catalogs were available off the shelf; indeed, most manufacturers had never built more than one out of 100 of the many basic sizes and types specified in their catalogs. Prices were still high, because they were geared to short runs.

This is where the Ferroxcube team came in.

And of course, where anyone is successful in a venture, competitors are sure to follow; Ferroxcube's success with low-cost memory systems has been no exception. In the two or three years that these systems have been on the market, swarms of other manufacturers have followed suit—notably the Standard Memories Corp., Datacraft, Sanders, and Fabri-tek. In fact, Fabri-tek is reported to have begun a second round in the cost-cutting effort. Varian Data Machines has aimed at the same market, but with the Cadillac among memories—a good but expensive design.

Nevertheless, Ferroxcube is still shipping something like a thousand systems a month, and expects to see a seller's market that will grow for some time—with no lack of competition.

design pass, the team had an 8- μ sec memory, with costs gratifyingly reduced.

In the second design pass, the manufacturing engineer introduced techniques and configurations that further reduced the cost of the system, as shown on the bottom of the diagram on page 108. These changes required somewhat different circuits, and allowed some component reduction. They brought the cost down even more, but the group saw ways to reduce costs even further.

In the third and final pass, the team members analyzed the final package. They found that a large proportion of the cost was for cable installation and mechanical assembly—labor that cannot readily be automated. On the basis of this finding, they recommended a change from functional modularity to aggregate modularity. Subassemblies containing many single-function circuits, such as drivers and decoders, would be dropped in favor of subassemblies containing an almost complete memory system. They should be made in such a way as to allow the number of bits per word, the number of words, or both, to be extended almost indefinitely, by stacking the subassemblies together.

This approach not only cut costs quite sharply, as shown on page 109, but also increased reliability greatly because it drastically reduced the number of interconnections. It was, of course, ideal for mass production because these "memory slices" could be manufactured almost continuously. The particular bit-word combinations in which they would ultimately be packaged and sold could be left for later. Certain other modules, that needn't be produced in the same quantities as the memory "slices," were designed as separate entities. These include timing generators; only one is needed for many "slices" of memory.

Marketing experts found the cost per bit of this new design to be acceptably low, and applications engineers found that its compatibility with existing industrial systems was pronounced. For example, many users were able to use the memory without any experience with core memories or dynamic logic.

The catalog that was first issued for these new memory systems listed over 300 standard designs, all based on only nine modules, combined in various bit-word formats.

The market acceptance of this new class of memories—by all groups, from nonelectronic machine-tool designers to logic specialists who plan small data processors—was everything the company could have hoped for. Less than a year after their introduction, production of all modules was continuous, at rates exceeding the minimums needed for economical production.

Having achieved the major objective—a degree of market acceptance that would sustain large-scale production—the same marketing/engineering/production task force sought to extend the benefits of this volume to faster memories. The resulting new generation attains full-cycle speeds of 2 to 3 μ sec, and split-cycle speeds of 1 to 2 μ sec, and can be modified to operate even faster. The principle changes in design are integrated logic circuits for most of the control and decoding electronics, improved sense amplifiers, and faster cores. These faster memories are now produced at about the same low prices as were the original 8- μ sec first-generation designs—thus opening still wider markets for the small memory system. ●

Economy Transistors

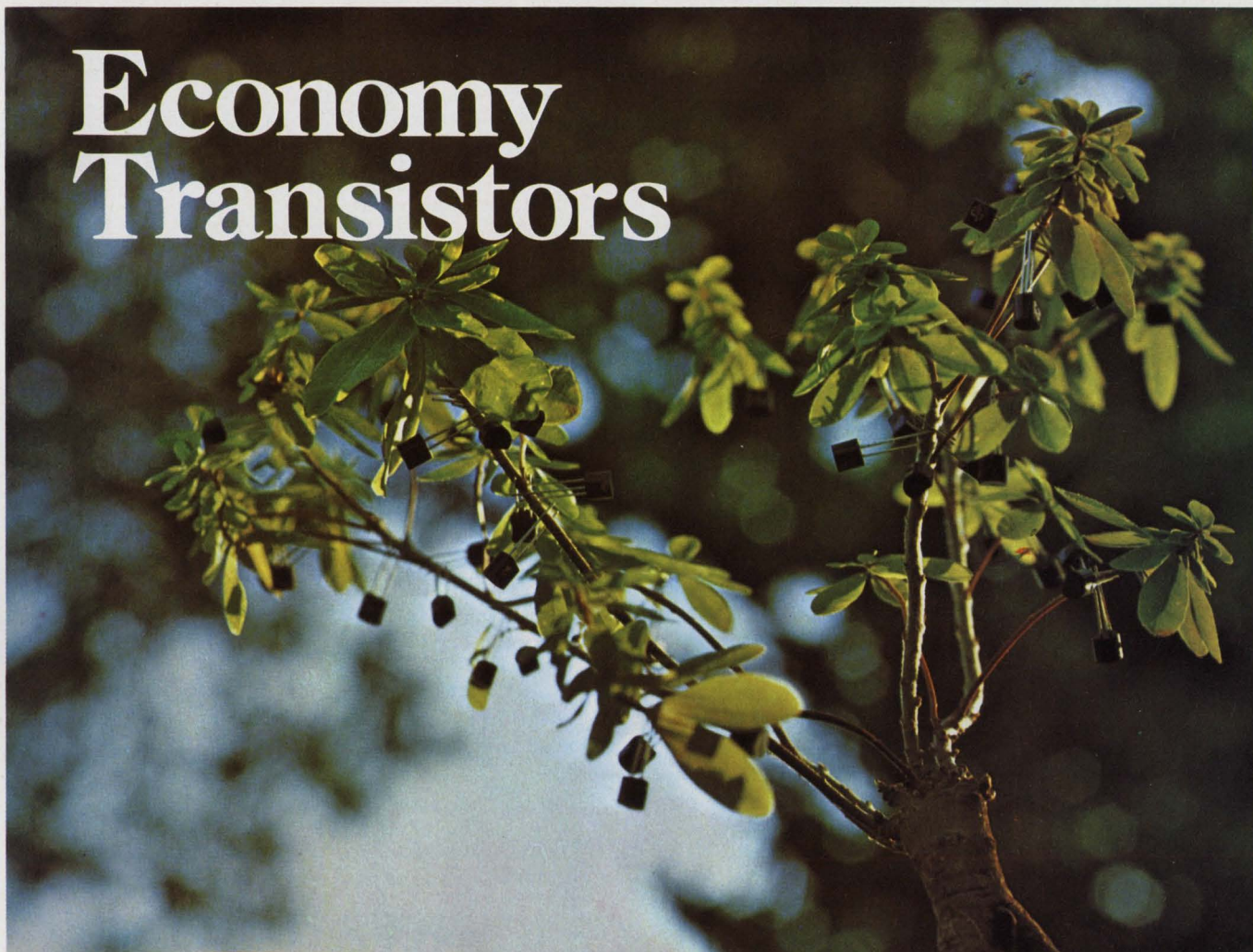

The money tree

Shake it and watch your transistor costs fall 50% and more! Below equivalent metal-can devices.

TI's exclusive pin-circle, as well as in-line, plastic packages now let you replace all equivalent TO-18 metal-can transistors with Silect* bipolars and FETs.

Why not switch and save on small signal and low noise amplifiers, oscillators, mixers and converters.

Reliability?

It's there. TI put Silect samples through 33-million hours of 17 tough MIL-STD tests. They proved just as reliable as their metal-can counterparts when tested under normal use conditions.

Now TI shakes the tree.



To save you time and money in specifying devices, TI has selected 52 Silect transistors as part of its preferred semiconductor line. Months of computer demand analysis show that the 52 meet 90% of cost-critical circuit requirements.

All 52 are popular, proven and readily available from TI distribu-

Preferred Silect Transistors

NPN BIPOLAR		PNP BIPOLAR		FET			
TIS 63	TIS 97	2N3705	2N4994	TIS 37	2N4059	TIS 58	2N5245
TIS 73	TIS 98	2N3706	2N4995	TIS 38	2N4060	TIS 59	2N5246
TIS 84	TIS 99	2N3707	2N4996	TIS 93	2N4061	TIS 73	2N5247
TIS 86	TIS 100	2N3708	2N4997	TIS 93M	2N4062	TIS 74	2N5248
TIS 87	TIS 101	2N3709	2N5449	2N3702	2N5447	TIS 75	
TIS 92	TIS 108	2N3710	2N5450	2N3703	2N5448	2N3819	
TIS 92M	2N3704	2N3711	2N5451	2N4058		2N3820	

tor and factory stocks.

Write for TI's brand new 1970 *Preferred Semiconductors and Components* catalog: Texas Instruments Incorporated, P.O. Box 5012, MS 308, Dallas, Texas 75222. Or just circle reader service card number 169.



*Trademark of Texas Instruments Incorporated

TEXAS INSTRUMENTS
INCORPORATED

In-depth product-planning bears fruit

Companies find that technical capability alone doesn't guarantee profits;

● Each year, March brings many old friends back to New York—spring, the New York Mets, and, for electronics fans, the exhibitors at the IEEE Show. After packing the samples, hauling them, and setting them up in the giant New York Coliseum, the vendors brace themselves for their 70,000 visitors.

It's then that product planners are put to the test. Turning an idea into a product that sells and makes a profit is an intricate procedure, and in many instances it demands a greater technical effort than building the product itself. How well have they judged the customers' needs, and how well have they been able to relay this information back to their own product development laboratories?

Being first with an innovation is not necessarily a guarantee of success in the marketplace. The history of the electronics industry abounds with cases of companies which although first in a technology are now only marginal participants. What counts is the degree of success in matching technology with what the customer wants. And, even following a recognized leader isn't always a sure route because the leader's plans may sometimes be either wide of the mark or incompatible with the follower's capabilities.

Here are six new products appearing at this year's show. Each exemplifies the strategies involved in planning new products.

▶ The digital IC tester from Tektronix shows how flexibility is built into a product to cover the user's needs for at least the foreseeable future.

▶ Fairchild's LSI tester shows how the steadily increasing complexity of LSI circuits was factored into a new approach to the application of test signals to the devices.

▶ The Teradyne large-scale integration test system illustrates how user's needs in software were merged with optimum use of computer memory and parameter test ranges.

▶ The programable pulse generator from the Datapulse division of the Systron-Donner Corp., illustrates that sometimes a good idea has had to wait for the applications to develop for it.

▶ The hybrid thick-film digital-to-analog converter built by the Dattel Corp., shows how a small company must get a jump on competition with factors beyond the simple performance specifications.

▶ Finally, the pulse-code modulation communications

transmitter from the Canadian Marconi Co. indicates how a new market, opening up because of recent rulings of a regulatory agency, can be served with a flexible design approach.

These are, of course, no more than a sampling of the many new products that will be introduced at the 1970 IEEE International Convention and Exhibition. Some other new products are covered in the New Products section of this issue, beginning on page 159.

Digital tester handles 23 IC's on one test set

● Two years ago planners at Tektronix pondered the idea of building a digital IC tester that could test every specification on almost every type of integrated circuit available. Users wanted a system that could be programmed via digital computer, and could do dynamic tests such as rise and fall times, as well as d-c measurements, load tests, and functional tests. And, the system had to be flexible enough to accommodate different types of packages such as dual-in-line,

Load board. As many as 23 separate socket boards can be inserted into the center of the load board enabling the user to test most of the digital IC's on the market. With this scheme only one test fixture is necessary.

in electronics bowing at the IEEE Show

it's knowing who to sell to, what to sell, and when to sell it that counts

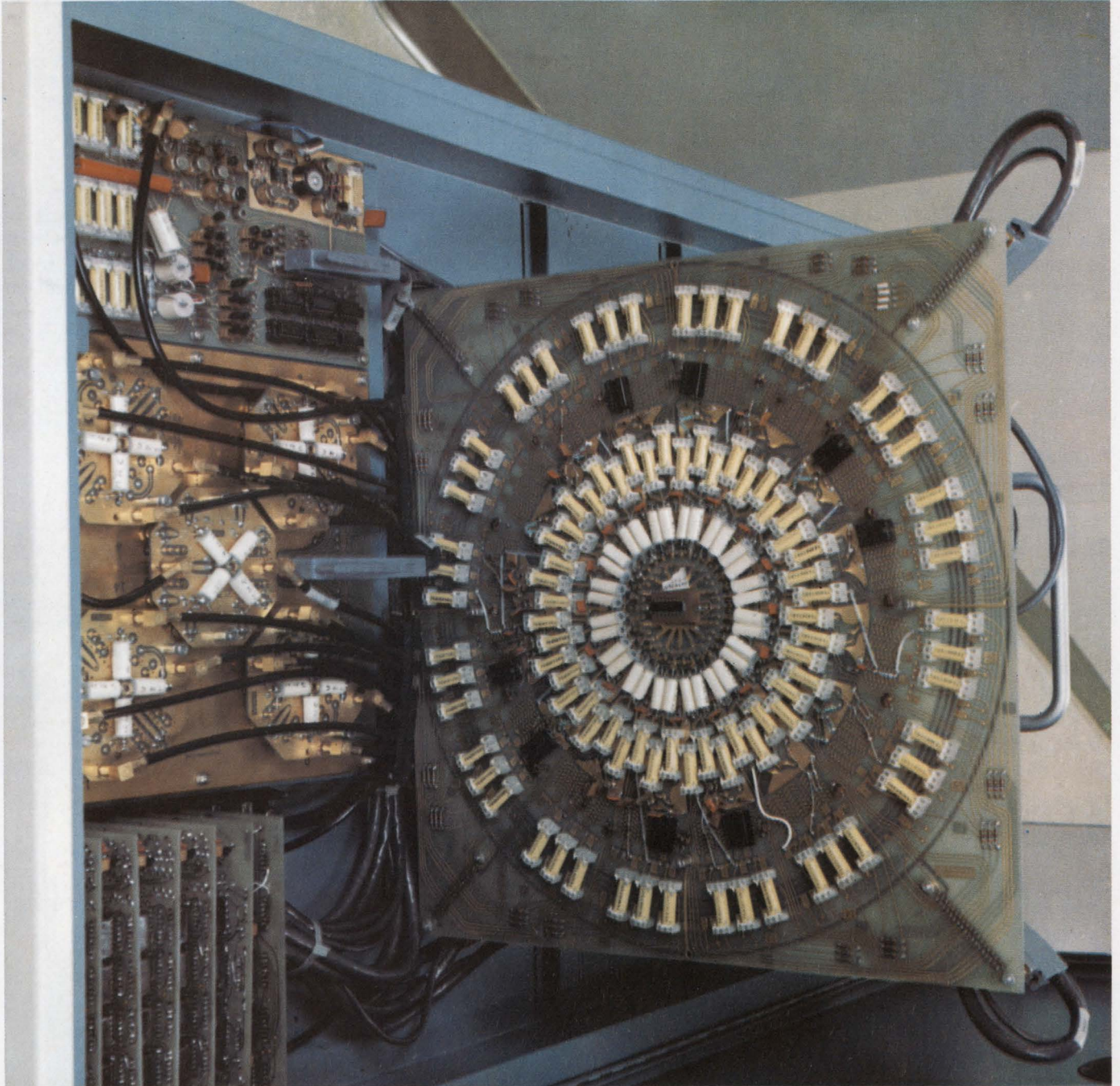

flat packs or TO cans.

The system, the S-3150, comprises a PDP-8 computer with a disk memory, two tape transports, a tape control unit, an ASR 33 input, and the test fixture. Tests can be performed on a go/no-go basis or on a diagnostic basis at rates up to 100 measurements per second to an accuracy of 1%. Higher accuracies can be obtained with an optional digital voltmeter. The computer's memory has the capability of storing 1,080 measurements and can be programmed to stop on each measurement. Data on each measurement can be logged during the test or just on an error indication.

The system's risetime of less than 1 nanosecond assures it of accurate dynamic measurements for most IC devices on the market over the next few years. Its d-c measurement capabilities span a range from ± 10 millivolts to ± 100 volts and current measurements down to 5 nanoamperes. The system measures voltage and current outputs in the logic 1 and 0 state, clock pulses, clear pulses, propagation delays and does these on logic types such as transistor-transistor, diode-transistor, and multi-emitter-coupled logic.

The problem of the multiple test fixtures was solved with a circular load board divided into 16 segments, each containing two IC sockets as load terminals, reed relays, load networks, and power supply lines. Underneath this board is a probe board. Sixteen sampling probes are switched through a multiplexing system to pulse generators, drive circuits, loads and power supply lines. The probes can sample voltages on any combination of two pins at a given time for the digital circuit under test. In all, 23 separate socket boards, 2 inches in diameter, can be inserted into the center of the load card.

The software package comprises a translator program which simplifies the writing of test programs. The translator program asks the operator which test parameters around the socket he wishes to change. From these answers, a test program with the parameters is compiled. This is subsequently stored on the magnetic disk memory which controls all the measurement instruments. A collection of more than a thousand different programs can be stored on the disk each automatically called up in sequence. The operator needs only to dial in the starting address of the program. Each pin of the IC socket is automatically

programmed by the instructions on the disk.

The test instruments such as the programable scope, the programable power supplies, and pulse generators are automatically set for a certain range of readings by the operator's response to a programmed selection stored in the computer such as the setting of a power supply. However, the value of the parameters can be changed at any time by the operator.

The price of the Tektronix S-3150 digital IC tester is \$120,000 with delivery expected to be in the third quarter of 1970.

Tektronix Inc., P.O. Box 500, Beaverton, Ore. 97005 [Booth 2G25] [491]

Direct tie to output pins speeds up LSI tester

● The design philosophy behind LSI testers was re-evaluated by product planners at Fairchild Systems Technology. One basic method is the matrix approach. This uses programmed power supplies and measurement sources which are connected to one side of the matrix to produce the desired stimulus or input excitation while the other side of the matrix consists of the output pins of the large-scale integrated package where the response is observed. Fairchild planners feel that the matrix approach slows down the speed of the system as the number of pins increases; large stray capacitance and leakage occur which tend to degrade the electrical performance of the system.

What Fairchild has done in their new LSI test system, the Sentry 400, has been to tie the electronics—the drivers and detectors—directly to the pins. The tie eliminates the matrix, and the system can then be run strictly with functional tests and d-c measurements. Dynamic testing such as measuring rise and fall times has been done away with. If dynamic tests were made, they would have to be made on each pin and for each internal state that the logic function undergoes. This adds up to an enormous number of measurements. With the steadily increasing complexity of LSI circuits, this will mean



Expandable. The Fairchild system's modular approach to testing LSI circuits allows packages containing any number of pins up to 240 to be tested. And several stations can be multiplexed giving the user the capacity to test circuits at different stations simultaneously.

added time and money spent on this phase of testing.

"Our approach," says Adam Mentis, program manager, "is to make a high-speed functional test on the unit at the speed for which the device was designed. The output can then be checked for the proper logic states."

In designing its system for maximum flexibility, Fairchild has incorporated two other features. One is a modular approach that allows LSI packages containing various numbers of pins up to 240 to be tested depending on the size of the package; the other is the addition of multiplexing. The system is capable of multiplexing four stations, thus giving the user the capacity to test different types of circuits at different stations simultaneously.

Mentis anticipates that the typical system configuration of the future will contain three or four test stations. This allows the customer to use one or two stations for production purposes such as wafer probing while the remaining stations can be doing engineering evaluation or new program debugging. Right now, says Mentis, customers don't have high enough volumes to warrant multiple stations, but unquestionably they will be the thing of the future.

Another significant feature of the Sentry 400 is its built-in self-checking capability. As LSI circuits get increasingly complex, so will the testers, and, therefore, it is important that bugs in the test system can be solved when and if they come up. Since the system has a computer—built by Fairchild—the computer can be programmed to run checks on the LSI tester.

The system has the capability of performing as many as 100,000 tests on one logic array if need be. The system performs the functional tests at a rate that can vary from 20,000 to 286,000 functional tests per second and 250 d-c tests per pin per second.

The computer is the primary controller, and test instructions are stored on a disk or magnetic tape to be transmitted to the computer memory when required. The test head, power supplies, and timing controls receive their instructions from core memory under the computer's control. In functional tests, the tester applies logic levels representing forcing functions to the input pins of the array under examination and compares actual outputs to the predicted responses on a go/no go basis. Expected output thresholds are programmable, as

are input logic levels. The computer controls the device handler so that wafer indexing and class sorting is done automatically.

The system can be used in any of three modes depending on the type of testing. In the automatic mode, the operation is handled under program control intended for production environment. The manual mode is a single-step execution where the operator needs to check through the program for verification or changes. In the monitor mode the operator has a variety of options such as modifying programmed voltages, or requesting a teletypewriter printout of the voltage on a specific pin.

The price for the system will run anywhere from \$150,000 to \$300,000 or more depending on the peripheral equipment desired and the number of stations needed.

Fairchild Systems Technology, 974 E. Arques Ave., Sunnyvale, Calif. 94086 [First mezzanine] [492]

Analysis sets guidelines for new 'SLOT' machine

● Product planning on Teradyne's J283 sequential logic tester, the so-called SLOT machine started two years ago, and may have begun in earnest with the hiring of T. Peter Sylvan [*Electronics*, March 4, 1968, p. 8].

Sylvan became project leader of J283, and as he tells it, planning began with a survey of anticipated large integrated circuit products, with special emphasis on families, functional complexity, pinning, and test requirements.

It soon became apparent to the planners that any large-scale integration test system would have to be able to check not only transistor-transistor/diode-transistor logic-type devices, but also the growing numbers of metal oxide semiconductor arrays.

This LSI forecast gave Sylvan and his team a grasp of what the new system would have to cope with, and from there they began development. However, some major characteristics already had been decided. Teradyne was committed to computer control and to func-

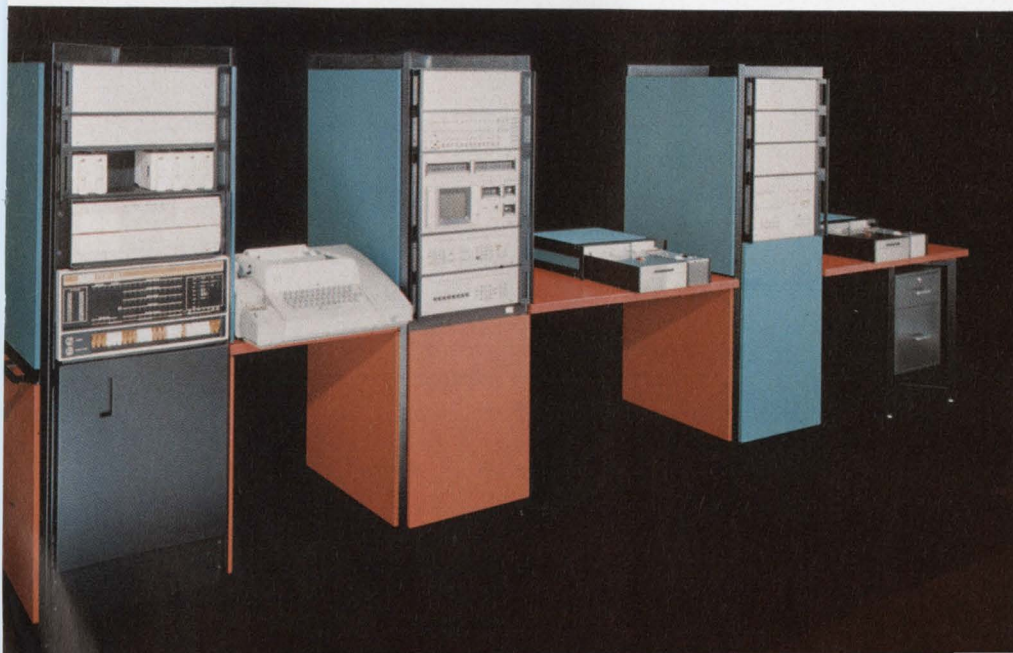

Reverse drive. Teradyne's J283 is capable of driving output pins on LSI packages and then examining the inputs for any flaws. Fanout characteristics are tested by using the drivers to load the output pins.

tional and parametric analog testing. Thus, the Teradyne team set out to design a computer-operated, functional LSI tester. Immediately a three-pronged tradeoff arose. The system's design had to take best advantage of the computer while using the least memory. The team also had to pick the best range of test rates. Furthermore, the software had to be designed to mesh with the first two requirements while making it easily understood (and partly alterable) by the user.

The major elements in the SLOT machine are split between a computer-controlled mainframe and one or two satellite stations. Each satellite can work with up to four multiplexed test stations. And, each station can do different tests concurrently at 20,000 to 50,000 tests per second.

Any test station can be used manually or connected to automatic handling equipment, prober or environmental chamber as long as test activities fall within the bounds of the software.

J283's can test LSI devices with up to either 40- or 64-pin packages.

Software allows the user to select either or both of the drivers and either or both detectors at any given pin. As a result, any combination of inputs or outputs can be tested. Teradyne has included a patch panel in the test fixture. This makes it possible to install a jumper among pin locations to test a circuit type without making any changes in the software.

The J283 "drives output and listens to inputs," according to Sylvan. The idea is to spot, for example, input flaws that, but for the J283's capabilities, might go undetected. When driving the outputs, the J283 uses its drivers to load the output pins, thereby testing fanout characteristics. According to Sylvan, this feature was so attractive to customers that it was made a standard feature on the J283.

Sylvan says the J283 uses a proprietary passive driver instead of the op amp within some sort of feedback loop that would normally be used. There are no active devices between the voltage reference and the pin that is driven.

This immediately solves three problems, notes Sylvan: "First, it's possible to drive devices which normally would oscillate in combination with typical drivers. Second, we can place capacitive loads at outputs without triggering driver oscillation. Third, we're able to achieve current limiting in well under ten nanoseconds."

This third point is especially important to users testing MOS circuitry as it guards against the possibility of ruining the MOS device while testing it.

Since "it's easy to be careless in any computer-controlled system," according to Sylvan, Teradyne has taken extra care to protect devices under test. Kelvin contacts are used throughout; stray current which might otherwise destroy an MOS device is bled to ground.

While initial units will be tailored to either 40- or 64-pin packages, the package size and pin number available on special order is arbitrary. Teradyne spokesmen call the boards "bricks," and to add pins, the user adds bricks up to the limits of available rack space.

Software features like data logging, dating, life data taking, and the other forms of information collection all are available. Some sections of the software package can be adapted to test a particular LSI device.

Deliveries are set for March. For a 40-pin LSI capability a user will pay approximately \$123,000; for a 60 pin tester, the price will rise to about \$143,000, depending on the degree of customization.

Teradyne Inc., 183 Essex St., Boston, Mass. 02111 [Booth 2B03] [493]

Pulse generator fits in where time is money

● "Don't sell automatic test equipment to the automatic-test-system market; sell it to the manual-test-system market." Howard Mette, marketing manager at the Datapulse division of the Systron-Donner Corp., speaks from experience.

About two years ago, Mette made a study of how engineers used pulse generators and found that about a third of the general-purpose manually controlled generators go into some sort of manual test system. "We noted that the pulse generator was the most difficult instrument in those systems to set up because it had seven major parameters (delay, repetition rate, pulse and baseline amplitude, width, and rise and fall time) to set. Each time a given test is run, it typically



Easy setup. Datapulse's programmable pulse generator can be setup with printed-circuit cards containing interconnected discrete resistors. Up to 15 cards fit into the generator, and any one of them can be selected by front-panel pushbuttons.

takes an operator, even a good operator, 10 to 15 minutes.”

It was this setup time that Datapulse engineers set out to eliminate. The new generator's output parameters can be set with printed-circuit cards containing interconnected discrete resistors, plugged into the back of the unit. Up to 16 cards fit into the generator, called the model 150, and any one of them can be selected with front-panel pushbuttons. The programable pulse generator has about the same specifications as Datapulse's older models. Repetition rate goes up to 50 megahertz; amplitude to 10 volts; pulse width to 10 milliseconds; and rise and fall time down to 5 nanoseconds.

After looking at a lot of ways to program a pulse generator, Datapulse engineers decided on a p-c card approach. Recalls Mette: “The idea of a programable pulse generator has certainly been with all manufacturers since the late 1950's; everybody has thought of it as something that was going to happen tomorrow.” But, he says it didn't begin to materialize until a year or so ago. The company's engineers analyzed the situation and saw that the delay was due to the inherently high cost of the initial equipment as compared to manually-controlled generators. “On top of that,” he says, “you have the cost of software. So it boiled down to unless you had a pretty high-volume item to be tested, a truly automatic test system wasn't feasible. So for this reason, not only programable pulse generators, but programable anything, haven't taken off over the last 10 years as had been predicted.”

Besides being faster, Mette feels that the model 150 is also more accurate because it eliminates the dial twiddling. “Manually-controlled pulse generators are inherently inaccurate instruments,” he points out. “They're calibrated at the end of their ranges. In between you have to use an oscilloscope or a counter to adjust the parameters.”

The 150 is just one part of a 16-member family of pulsers, set apart from each other by their specifications and the means used to control them. Besides program cards, the new generators can also be controlled manually or externally. Some of them also have sequencers that step the generators through as many as 16 different outputs.

The pushbutton model will go for \$1,500, \$1,100 more

than an older one. But that price difference doesn't upset Mette. “It will be easy to show that in about 90 days this instrument is going to make up the \$1,100 in operator time,” he says.

Datapulse Division, Systron-Donner Corp., 10150 W. Jefferson Blvd., Culver City, Calif. 90231. [Booth 2811] [494]

New, small d-a converter is entirely self-contained

● A new firm generally regards product planning in a different light than does an older, established company. This is especially so if the product, like the Datel Corp.'s new Hybridac digital-to-analog converter, represents one of the firm's first efforts in this direction.

The Hybridac is billed as the industry's smallest self-contained d-a converter—2 by 2 by 0.4 inches with pins arranged to allow it to plug into wire-wrap boards now popular with users of dual-in-line packaged integrated circuits. The \$69 eight-bit version is also billed as the least costly of present d-a converters.

Datel's sales manager, James Zaros, says that the company, being brand new and having to compete with established firms, had to have selling points like price, package size, and convenience to attract customers at the start. “After making a name for ourselves,” he says, “we could afford to sell on merit.”

But, good specs alone might not have been enough to make Datel succeed. In the studies of customer needs, Datel's planners found that most p-c mounted converters were larger than customers liked. Also, though very small, the modular converters usually required out-boarded voltage references or other components. Thus, it seemed good strategy to design one small package with everything needed inside.

To conserve space in racks, a thickness of 0.4 inch was needed: if the converter were any thicker, a printed circuit board mounting slot would be wasted, and the effort spent on miniaturizing the Hybridac would be only an exercise in futility.

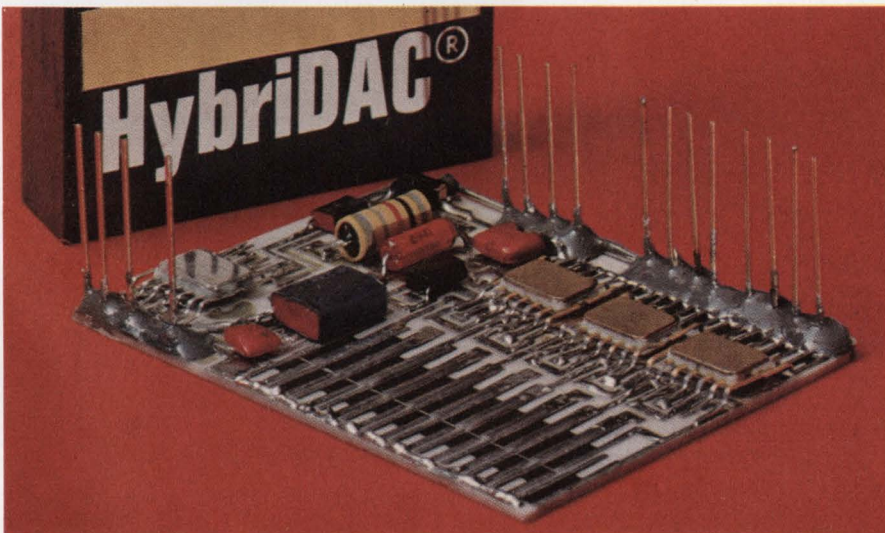

Hybrid. The digital-to-analog converter from Datel offers everything in one small package. Included are input interfacing logic, switches, ladder network, reference voltage source, and output amplifier.

Datel wound up building the converter in hybrid circuit form. "Although our cost analysis showed that we could buy a p-c board of the same size for about one third the cost of an alumina-hybrid substrate," says Zaros, "the p-c approach actually cost more because we would have had to mount and match ladder network resistors and other components which would be delivered to us on the alumina." Zaros estimates that 40% less labor time is needed to assemble the hybrid than would be the case with a p-c card.

Also, he adds, the resistors in the ladder network came pretrimmed, and, because of alumina's good heat conducting characteristics, the relative values of the resistors tracked one another closely. The close thermal tracking eventually led to a temperature coefficient of only 30 parts per million per °C for the whole converter—figures of from 200 up to 2,000 parts per million were common for competitively priced units. Also, the Hybridac achieves an accuracy of $\pm 0.025\%$ of full scale and a very fast slew rate of 100 nanoseconds per volt.

So, Datel offers in a 1.6 cubic inch package, a complete d-a converter including input interfacing logic, switches, ladder network, reference voltage source (highly controlled by a combination of an operational amplifier and a temperature compensated zener diode), and output amplifier.

Three models are offered, the DAC-HB8B, HB10B, and HB12B for 8-, 10-, and 12-bit conversion respectively. These ranges also result from market research. Zaros estimates that 10- and 12-bit converters account for 50 to 60% of the market, with eight-bit devices adding another 30%. Higher and lower resolution devices battle for the remaining 10% or so, and are poor markets for a fledgling company.

Designed for compatibility with diode-transistor/transistor-transistor logic levels, the Hybridac's also can be programmed to supply either a bipolar or unipolar output code—a simple jumper or switch is the programmer.

Prices for single units in the series are: 8-bit, \$69; 10-bit, \$99; 12-bit, \$119. OEM discounts of 5% are available on lots of 10 to 24, 7% on 25 to 49 unit lots, and 10% for lots of 50 to 99. Delivery time for the units is now about one week, with engineering lots coming from stock.

Datel Corp., 943 Turnpike St., Canton, Mass. 02021 [Booth 3B29] [495]

Pcm setup is designed for the commercial user

● In the past, the users of pulse-code modulation communications systems have been the military, the space agencies, and the large telephone companies. However, recent rulings by the Federal Communications Commission, such as the Microwave Communications Inc. decision, have opened the way for private carriers to use pcm. And, Canadian Marconi feels that the time is right for the introduction of a commercial pcm system operating at microwave frequencies. In fact, the product planners at the Canadian communications company envision \$12 million in sales in the first two years of production.

The Marconi system, the MCS 6900, is a medium haul pcm system designed to operate at 960 megahertz, 2 gigahertz, and 12 Ghz and provide either voice, data or teletypewriter, high speed data, program sound channels, or tv. These requirements are tailored to the needs of the majority of commercial users such as small telephone companies, railroads, and oil companies. All were surveyed by Marconi during their planning program.

Even after the decision to go ahead was made, the planning still went on. Changes were made, such as a decision to abandon the use of a 6 Ghz carrier and substitute 12 Ghz; and, the development of the 2 Ghz system was pushed ahead based on anticipated sales projections.

Potential system cost can be estimated from the following example: five stations are required to operate over 100 miles with two 10-channel drops and 60 working channels. The cost for such a system, not including installation, would be about \$13.31 per channel mile. Individual channels can be added to each station at \$300 each to yield a system with 24, 48, or 120 channel capacity.

The system is designed to the standards of the Bell System's T1 channel bank. The MCS 6900 uses the $\mu=100$ companding law and a 1,544 kilobit/second bit rate, while the basic multiplex group consists of 24

"... it boiled down to unless you had a pretty high volume item to be tested, a truly automatic test system wasn't feasible."

channels of eight bits each sampled at 8 khz.

The system can be operated as a terminal installation, a straight repeater station, or as a spur link repeater. The repeaters have drop-and-insert facilities for any number of telephone channels up to the normal system capacity of 120. These repeater stations regenerate the pcm signal making the drop-and-insert and spur-link facilities possible. The system also can drop-and-insert any number of voice channels at the cost of a channel unit only.

The 12 Ghz transmitter uses a Gunn oscillator whose output is 150 milliwatts; the 960 Mhz and 2 Ghz transmitters use frequency-multiplier chains. The microwave signal is directly modulated by the pcm pulse train and fed to the antenna, a 2-foot diameter parabolic reflector mounted on a 35 or 50-foot mast. The receiver is superheterodyne with a Gunn-diode local oscillator and has a noise figure of 9.5 decibels.

The station-control unit of the MCS 6900 contains the signal and routing-control circuits whose functions include pcm clock and synchronizer, pcm channel synchronizer, delay circuitry to combine pcm pulse streams at the repeaters, and group combiners/decombiners to combine or separate up to five pcm groups of 24 channels. The channel units contain the modem submodules required to pulse-code modulate the input audio and to demodulate incoming pulse code modulation signals. A service-telephone unit provides a party-line telephone facility between all stations in the system.

A data and teletypewriter unit provides facilities for asynchronous digital transmission and reception of a maximum of 9,600 bits/second, which is the capacity of one voice channel. The system can accommodate up to 63 separate teletypewriter channels or a mixture of teletypewriter and data channels. For example, the MCS 6900 can be programmed to process three 2,400 bit/second data channels and 15 teletypewriter channels at 150 bits/second. Full data traffic access at one station is not necessary, and in the case of a multihop link, a few teletypewriter channels can be added at each repeater for up to a total of 63 for any one voice channel on the system.

Canadian Marconi Co., 2442 Trenton Ave., Montreal 301 P.Q., Canada [Booth 4A29] [496]

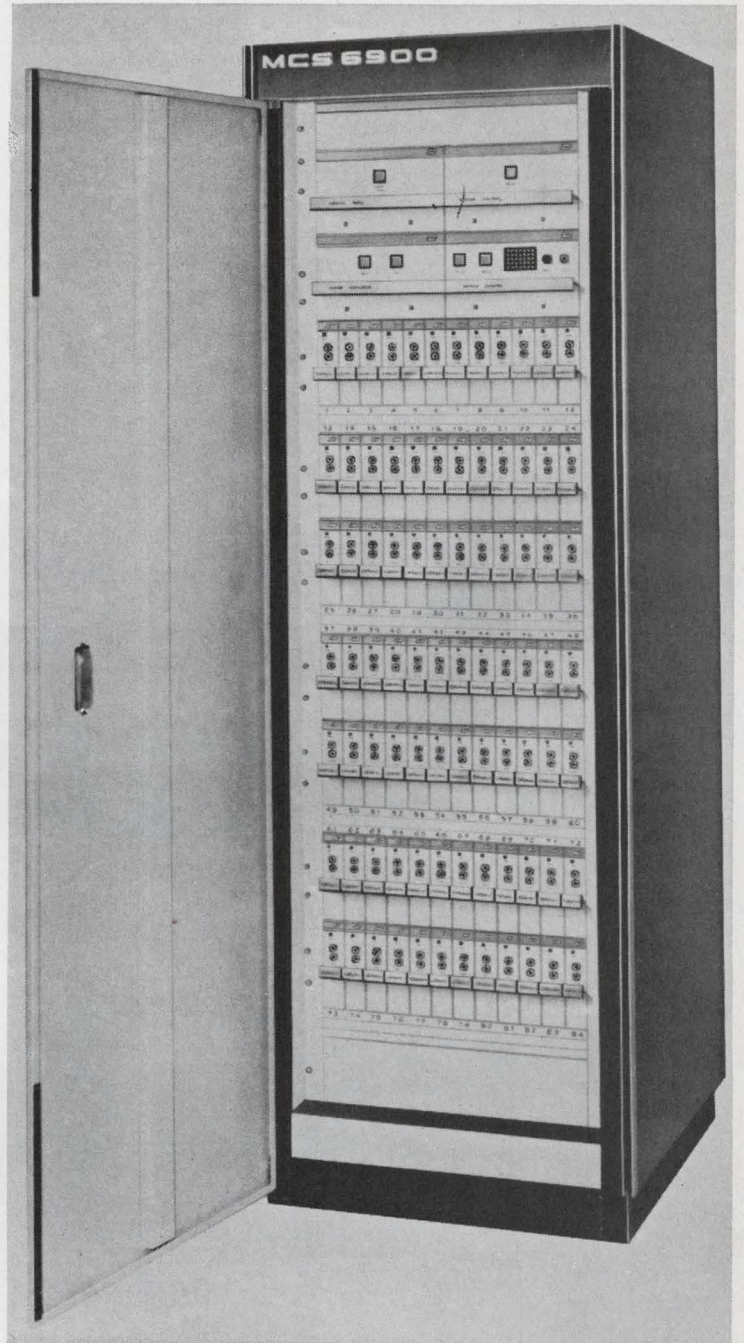

Private carrier. Canadian Marconi is marketing its MCS 6900 for the commercial user. The system is a medium haul pcm system designed to provide either voice, data, program sound channels, or tv.



Dot matrix display features inherent scanning ability

By propagating glow discharge from cell to cell,
'self scanning' effects sharp reductions
in addressing and drive circuitry,
says *William J. Harmon Jr.*
of Burroughs Electronic Components

Close up. Time-exposure photomicrograph of Self-Scan panel display shows net effect of strobed display of the letter E. Tiny points of light are the rear glow discharges. Large circles of light are the front glow discharges; blurred lines across these are the front anodes.

● Alphanumeric displays using tiny glow-discharge cells offer several virtues—among them high legibility and compactness. But up to now the door to commercial feasibility has been blocked by the costly address and drive circuits required in the glow-discharge matrix arrays. The Burroughs Corp. however, has devised a way to propagate the glow discharge from cell to cell that reduces the amount of external components by 90%, and along with this has come the price reduction needed to put the displays on the market.

Each of the new Self-Scan panels can display 18 characters in the standard ASCII five-by-seven matrix format; longer displays are possible with no increase in drive circuitry. The package is cheaper than a Nixie-tube arrangement for lengths greater than 10 characters. It's even less expensive than a cathode-ray tube display for lengths up to about 400 characters.

Unlike other multicell glow-discharge displays, the Self-Scan panel requires only d-c power (other versions, such as the University of Illinois and Owens-Illinois displays require a-c at a relatively high voltage, which is more difficult to generate and handle). And Self-Scan displays operate entirely from digital signals, and interface easily with standard MOS integrated circuits.

The Self-Scan display is constructed on an insulating sheet containing 0.036-inch-diameter holes with centers spaced 0.060 inch apart, and is sandwiched between

two parallel glass sheets, as shown on next page. Anode wires pass over both ends of the holes, and cathode strips are interspersed between the bottom anode wires and the matrix sheet. At the panel's edges, the conductors pass to the outside through a glass seal.

The assembly is filled with a mixture of gases, mostly neon, under low pressure. Each hole with its anode wires and cathode strip acts as a small gas-discharge cell. The back anode wires help propagate the scan across the matrix, while the front anode wires perform data-entry: they determine which cells light up.

With the brute-force method of scanning a gas-discharge cell matrix—unlike the new technique—each column in the matrix under external control would be energized in sequence by switching on a cathode driver. In synchronization, and still under external control, the proper cells in each column would be lighted up by switching on the anode drivers for the appropriate rows. To write the characters BR, for instance, as shown on next page, the external circuitry would turn on cathode drivers 1 through 11 one by one. When column 1 is on, the external circuitry would turn on the anode drivers for all the rows. When column 2 is on, the drivers for rows 1, 4, and 7 would be on; the same would be true for column 3. For column 4, rows 2, 3, 4, and 7 would be on. This procedure would continue until the characters were written.

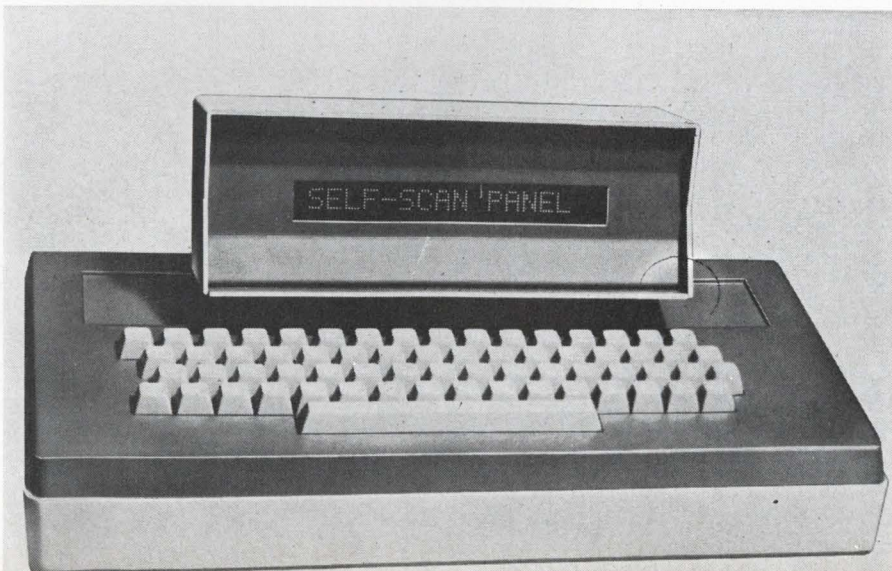

Hardware. So far, Burroughs has built Self-Scan panel displays in 16- or 18-character lengths. Longer arrays are practical, and would require no increase in external circuitry.

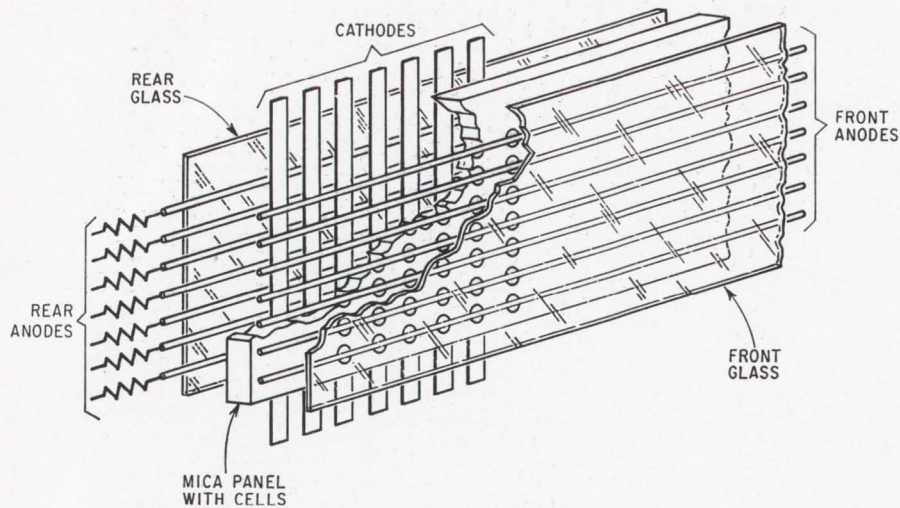

Multiglow. Self-Scan display panel consists of mica panel matrix of holes sandwiched between glass sheets. Cutaway view shows relation of conducting grids: horizontal rear anode wires, vertical cathode strips, and horizontal front anode wires. Assembly is only one-half-inch thick, and is hermetically sealed.

In addition to the required decoding and row- and column-addressing circuits, each row and column would need a separate driver transistor. A 20-character display, for example, would require two 1-out-of-10 decoders, two decade counters and 10 logic inverters to scan the columns, as well as seven anode-driver transistors and 100 high-voltage cathode-driver transistors. The number of cathode drivers always would be five times the number of characters in the display; these are expensive transistors because of their high voltage rating.

In the Self-Scan panel the same 20-character display would require seven anode-driver transistors, a dual flip-flop, a quad gate, five resistors, four diodes, one zener diode—and only four high-voltage transistors. This is the total complement, regardless of the display's length.

The panel employs two gas-discharge effects—glow transfer and glow priming—and three-phase pulsing of the cathode. To start the character-writing process, a pulse is applied to a reset cathode, as shown opposite, reducing the voltage on that cathode from 110 volts to 0 volts. All other cathodes are held at 110 volts.

During the reset pulse, the gas surrounding the reset cathode ionizes and glows as a result of the large voltage between the rear anode and the cathode—approximately 250 volts before ionization occurs and 170 volts after ionization. There is no ionization on the other cathodes—their voltage difference with respect to the

rear anode isn't large enough.

The other cathodes are connected so that every third one after the reset cathode has a common line, as shown in the diagram opposite, and pulses are applied to each line in sequence.

As the system is clocked, the reset pulse is removed from the reset cathode and returned to 110 volts, while a pulse applied to the phase-1 line reduces it from 110 volts to 0 volts. Now cathodes 1, 4, 7, 10, etc. have a 250-volt potential difference with respect to the back anode. The ionization on the reset cathode stops. But some of the charged particles surrounding the reset cathode are swept to the adjacent cathode 1, through slots in the panel, by the ground potential provided by the phase 1 line.

These charged particles, along with metastables, form a nucleus for ionization, and a glow discharge between the rear anode and cathode 1 is established very rapidly. The metastables diffuse from the reset cathode, during ionization, to the first cathode. (Metastables are gas atoms that have been raised to intermediate energy levels; they can't return to the ground state without interacting with other particles. Since they're not charged, they're not affected by electric fields.)

But nothing happens at cathodes 4, 7, 10, etc. Though they are at the same potential as column 1, they are too far from the reset cathode to receive any metastables or

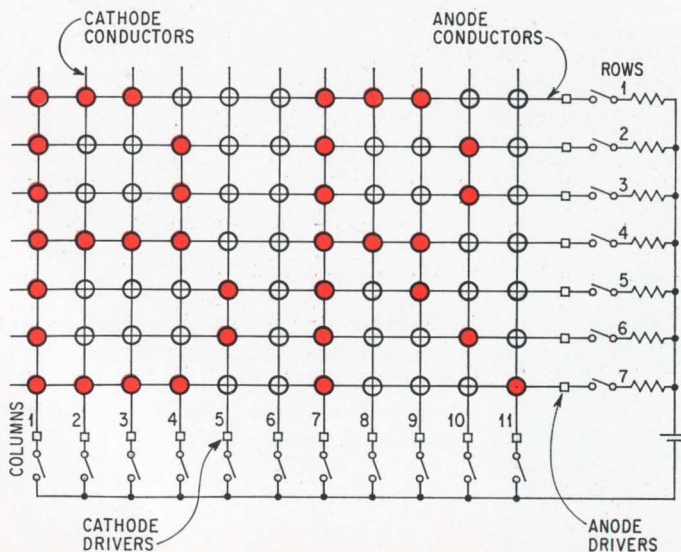

Brute force. In other displays, the display must be written by coordinated addressing of the anode and cathode grids. This requires many discrete components and integrated circuits.

charged particles. Column 1 ionizes before they have a chance to, and once ionization has started, the anode sustaining voltage drops below the breakdown voltage of columns 4, 7, 10, etc.

When the system is clocked to period t_2 , the phase 2 line drops to ground potential and phases 1 and 3 are held at 110 volts. Again, ionization occurs on the cathode adjacent to the extinguished cathode—cathode 2 ionizes in this case—because of the metastables and charged particles. And other cathodes on the same line—cathodes 5, 9, 11, etc.—won't ionize because the anode sustaining voltage is below their breakdown voltage.

During period t_3 , phase 3 is at ground and phases 1 and 2 are at 110 volts. Ionization occurs at cathode 3, and cathodes 6, 9, 12, etc., are prevented from ionizing.

In this way ionization is transferred to the last cathode in the display. Then, at the next clock pulse, the reset cathode is brought to ground potential, it ionizes, and the whole sequence repeats. The process of preferential ionization by means of metastables and charged particles from an extinguished cathode is called glow transfer. The glow discharge between the rear anode and the cathodes doesn't interfere with the display, since it's barely visible from the front of the display panel.

To light a particular cell in the matrix, the voltage on its front anode is increased—from 110 to 250 volts—at the same time that a glow exists between the cathode

Automatic. Self-scan functions by phased driving of the cathodes controlled by a system clock. First, voltage on reset cathode is dropped to zero to establish glow discharge between reset cathode and rear anodes (A).

When ϕ_1 voltage is dropped to zero, ionized particles and metastables (small arrows) from reset cathode quickly establish a glow discharge between cathode 1 and the rear anodes (B). Ionized particles and metastables also assure a rapid glow discharge between cathode 2 and the rear anodes when ϕ_2 is dropped to zero. This process repeats until all cathodes are scanned. The front anodes provide the data signals. To write the third column of the letter B, for instance, the voltages on front anodes 1, 4, and 7 are raised to 250v as ϕ_3 is dropped to zero (D). Metastables from the glow discharge between cathode 3 and the rear anodes ensure a quick—and visible—glow discharge in cells 1, 4, and 7 of column 3.

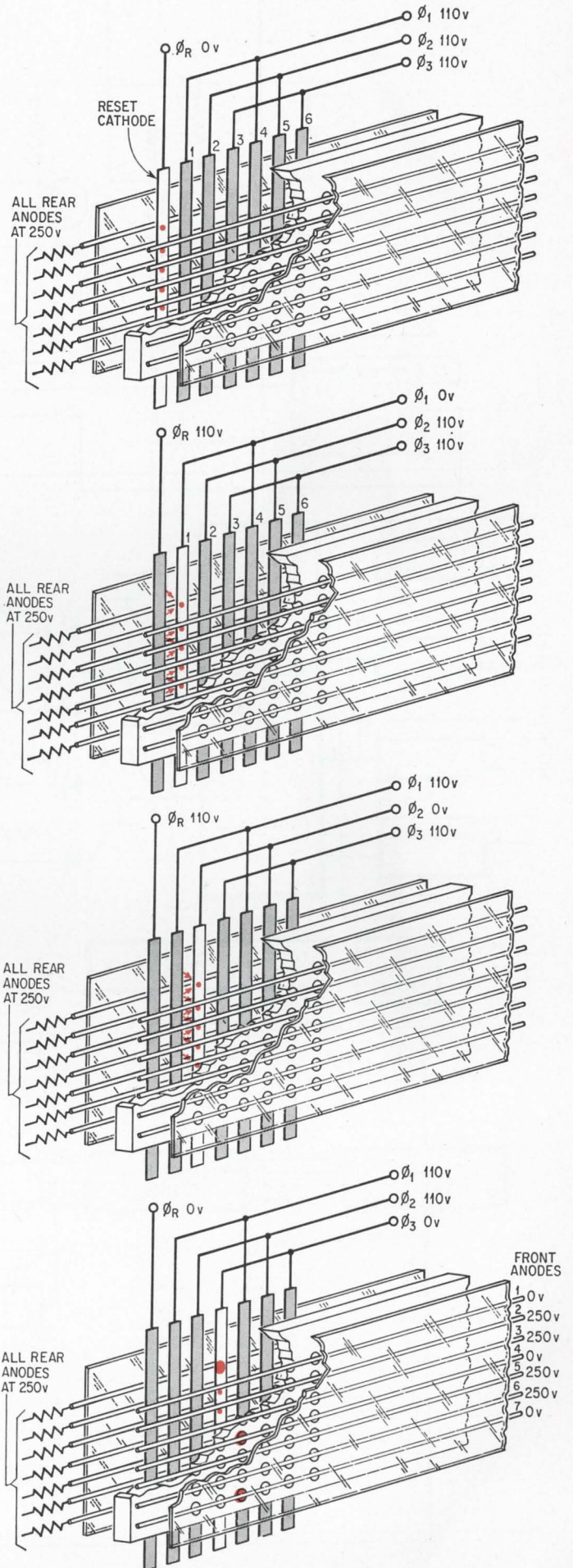

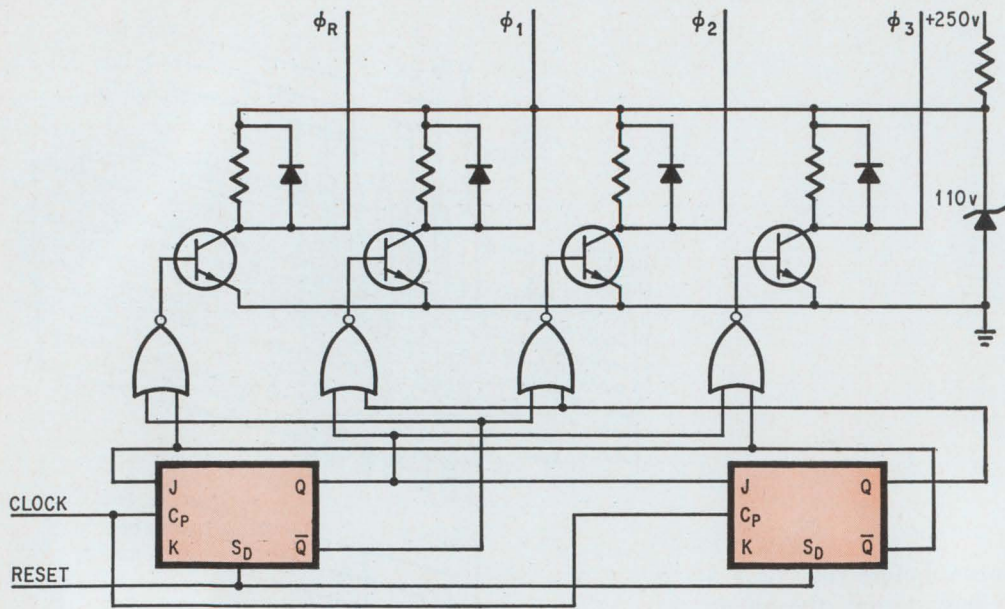

Simple. In the Self-Scan panel the circuits and components indicated by the shaded areas can be replaced by the much simpler configuration of flip-flops, gates, transistors, and passive components shown at top.

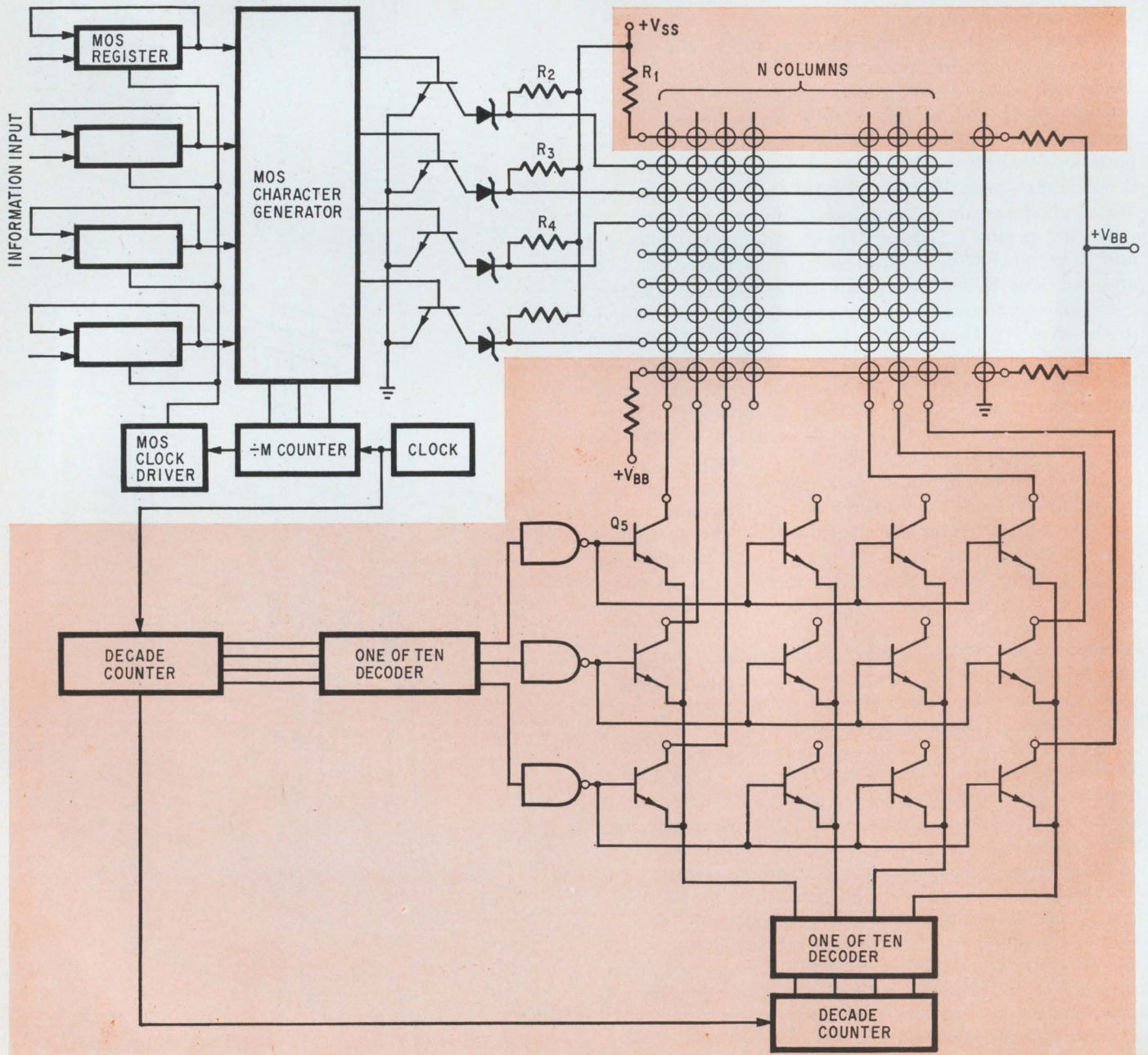

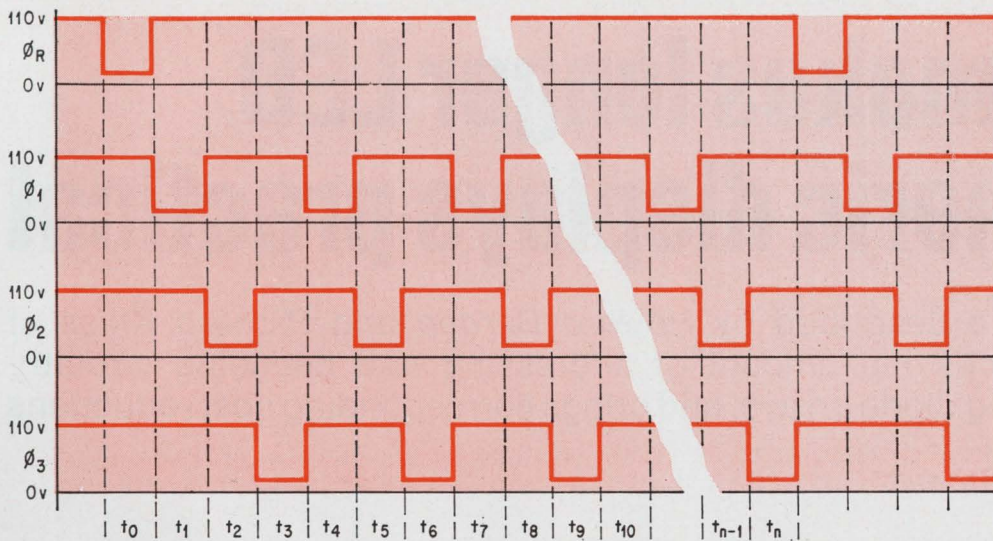

In step. Phased pulses help move the glow discharge between cathode and rear anode across the display panel. The ϕ_R waveform is applied to the reset cathode; ϕ_1 is applied to cathodes 1, 4, 7, etc.; ϕ_2 to cathodes 2, 5, 8, etc.; ϕ_3 to cathodes 3, 6, 9, etc.

and rear anode of the cell. Metastables from the back discharge diffuse through the cell and initiate a glow-discharge between the cathode and the front anode. This glow, of course, is visible from the front of the Self-scan display panel.

Since every third column has a common-phase line, every third column crossed by the front anode has a potential difference sufficient for breakdown. But front breakdown occurs only where there is a back breakdown in the same cell. This is because metastables emanate from only one column—the one with back breakdown—and thus insure that ionization occurs first in the cell connecting the cathode of that column with an energized front anode. Once the ionization is established there, the front-anode potential drops to the sustaining voltage, and no other cells for that anode can ionize. Thus, metastables assure preferential ionization in response to data signals, an effect called glow priming.

The cell glow is extinguished when the system clocks to the next cathode, at which time the front-anode voltage simultaneously drops back to its normal low level of 110 volts.

The display panel can be made in any desired size. It can be made longer by adding more cathodes in a longer matrix sheet, and it can be made higher by adding front and rear anodes and a taller matrix sheet. The scanning method doesn't change as the display is en-

larged. However, as the display is made larger, an additional number of phases are required to insure sufficient time for the gas to deionize before the same bus is re-energized.

One major difference in external circuitry between the Self-Scan display and one without automatic scanning is that a cathode-drive switch matrix is replaced by a simple three-phase clock, as shown opposite. Another important difference lies in the counter that drives the decoding circuit. Ordinary externally controlled scanning doesn't depend on glow transfer, so there is no need to drive the character-separation columns between characters. But since glow transfer across these columns must be provided in the Self-scan display for a five-by-seven matrix with two spaces between characters, the divide-by-5 counter must be changed to a divide-by-7.

In a complete Self-Scan display system, the master clock supplies pulses at a fixed rate. Each clock pulse advances the glow on the back of the panel to the adjacent cathode, thus selecting the next column. To eliminate observable flicker, the entire panel must be scanned 60 times a second. So the longer the display is, the faster the clock must be. The decoder provides seven output words per character, each word consisting of seven bits. An MOS memory is used for refreshing; after every seven clock-pulses, it is updated to provide a new input word to the character generator.

A multicell glow-discharge display can be designed with more than one row of characters. For example, if 14 anodes and 14 rows of cells were incorporated in the panel, two rows of five-by-seven characters would be provided. If the number of characters were small, the top row could be scanned first, then the bottom row. But since each row must be scanned 60 times each second to prevent flicker, each cathode would have to be scanned 120 times per second. This technique could reduce the duty cycle and cause light output to be below an acceptable level.

For the longer displays, then, it's better to scan both rows of characters simultaneously by providing 14 anode drivers and driving them all at the same time. For economy, the character generator can be multiplexed among the rows of characters; while the information for one column is being displayed, the data for the next column of both registers can be processed through the character generator and put into the storage register. ●

Strobing makes longer LED alphanumeric displays practical

Time-sharing technique described by *Howard Borden* and *Richard Kniss* of Hewlett-Packard reduces the amount of addressing and decoding circuitry needed for light-emitting diode arrays, and brings corresponding cost reductions

● Ironically, the major hindrance in implementing advanced types of alphanumeric displays hasn't been the display device itself. The decoding and driving circuitry has been the culprit. The sheer quantity of circuitry and interconnections needed to operate the displays can make them costly and awkward.

The problem is knottier for alphanumeric displays than for pure numeric. Here, thirty-five light-emitting diodes are combined in a five-by-seven matrix to form a single alphanumeric character. The decoding logic for converting the six-line input (in ASCII code, for example) into the driving signals for the 35 dots is quite complex, and, therefore, it would not be economical to provide a separate IC for each character. When LED arrays displayed only numeric characters [*Electronics*, Sept. 2, 1968, p. 74], there were only 10 symbols to decode and 27 dots per character to be lighted. The integrated circuit for decoding the 10 symbols could be incorporated in the same package as the LED array.

Fortunately, a solution for alphanumeric displays has come to light in the guise of a strobing technique developed at Hewlett-Packard for its LED arrays. Although the technique requires a few additional integrated circuits for timing and buffer storage, it eliminates the individual read-only memory decoders for each character; instead, all the characters share a single ROM. Interconnections are also minimized by strobing. The Hewlett-Packard

technique will permit a five-character display with only 32 leads. (For a strobed display of any size, the number of leads can be found from $N_L = 7 + 2N_C$, where N_C is the number of characters.)

However, with alphanumeric capability and with the convenience and economy of the strobing technique, LED displays should find wider acceptance in computer terminals, data handling terminals (in banks, for instance), instruments, and aerospace equipment. LED's are an attractive alternative to glow-discharge types of display primarily because LED's operate at low voltage and power (about 1.6 volts and 8 milliwatts per diode), and have an extremely long life expectancy. The latest reliability data shows that it takes 500,000 hours—perhaps longer—for the brightness to drop to half its initial level. An additional advantage is that the brightness of the display can be adjusted for different ambient light levels by varying the voltage.

Each LED is a gallium-arsenide-phosphide chip that emits red light when current is passed through it. A single character consists of 35 such chips mounted in a five-by-seven array on a ceramic substrate, and as many as five such characters can be mounted on a common substrate in a single dual-in-line-pin package. Characters are $\frac{1}{4}$ inch high and on $\frac{1}{2}$ inch centers. For displays more than five characters, the multicharacter assemblies are placed end-to-end with the same center spacing.

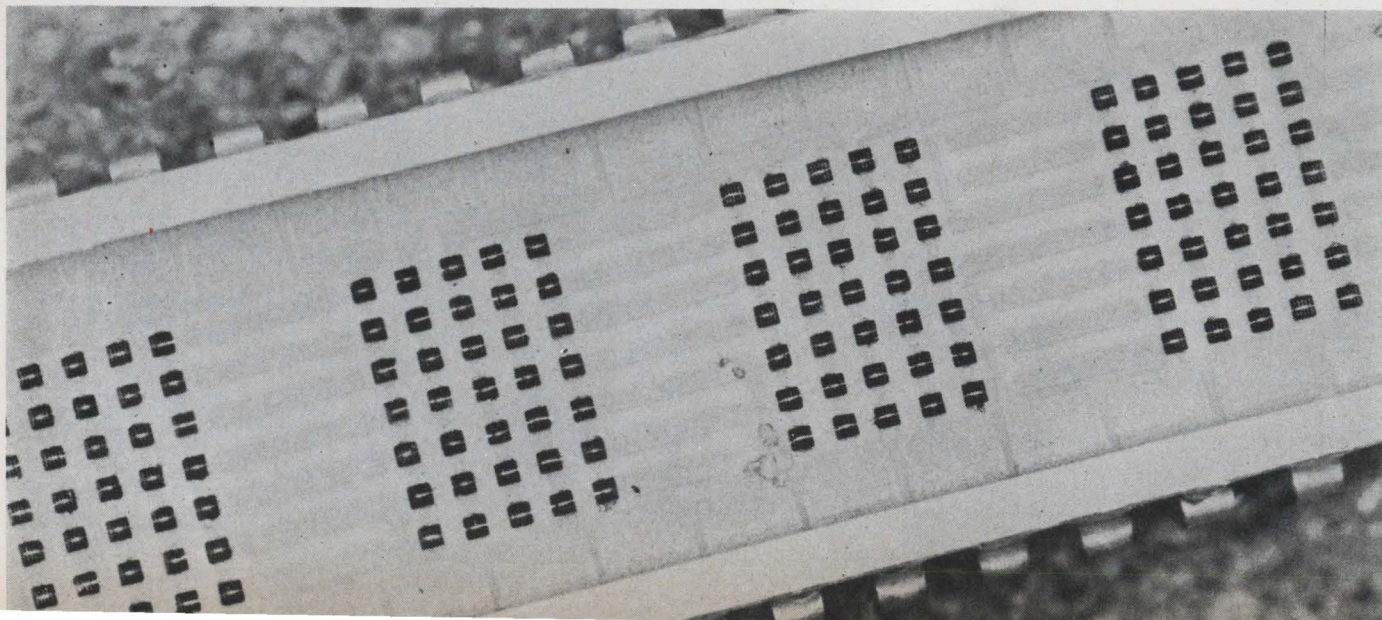

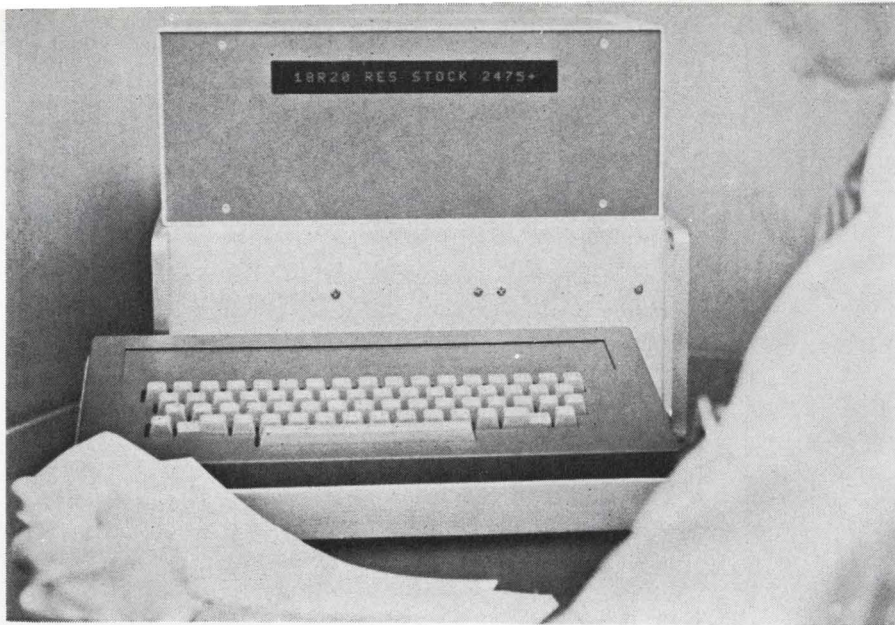

Taking stock. With the strobing technique, the cost of LED alphanumeric displays is low enough to open up applications in data terminal equipment for business and engineering.

Essentially, strobing is a technique for transforming input data into the electrical drive signals required to activate a matrix of light-emitting points. The activating signals are provided to either the rows or the columns of the matrix, in sequence. When the signals are applied to the rows, for instance, each column is lit briefly to trace out the character, the appropriate points in a particular column turning on simultaneously. As in a television raster, the sequence is repeated rapidly enough that the viewer doesn't perceive any flicker.

Consider the letter H. To write this character using horizontal strobing (vertical strobing will be explained later), all seven LED's in the first vertical column (1C in the diagram shown at top of next page) are connected to ground by a clock pulse. At the same time, a read-only memory, which has the ASCII code for the letter H at its input, determines that all seven LED's in column 1C should be turned on. The ROM, therefore, supplies current to each of these diodes through the seven lines leading to matrix rows 1R through 7R. A LED will light, of course, only when the circuit for its particular row and column is completed.

With the next pulse from a clock, the ground for the column 2C LED's is energized, and the ROM determines which LED's in that column should be turned on. For the letter H, the ROM would supply current only to row 4R to light up one LED.

Package. LED's form alphanumeric characters in a five-by-seven array. They are mounted on a ceramic substrate with dual-in-line pins and a glass cover. Arrays come in three, four, and five-character lengths that can be placed end-to-end for longer displays. Character height is $\frac{1}{4}$ inch; package height is 0.6 inch. Gold pattern on ceramic substrate connects to anodes of the LED's, wires on top of LED's connect to the cathodes.

The subsequent steps for completing the letter are similar: the steering counter indexes to the next column, and the ROM decides which LED's to turn on and drives the appropriate horizontal lines.

Writing several characters by horizontal strobing is just an extension of writing one character. A three-character display operated from a keyboard, as shown at bottom of next page, will illustrate the principle and the circuitry that's needed.

Several different ROM's are available for driving Hewlett-Packard's horizontally strobed display, for example American Microsystems' S8161, National Semiconductor's SK0002, and Texas Instruments' TMS-2A4842-MH. Similarly, many types of core drivers and counters, both metal oxide semiconductor and bipolar, are available for the rest of the circuit.

In the system shown, the keyboard feeds six lines of ASCII alphanumeric code in bit-parallel, word-serial form to three buffer-storage registers—one register for each character. The storage registers are sequentially reloaded; when register 3 has been loaded, steering counter 1 returns to register 1 and repeats the loading sequence. The strobing technique isn't limited to this method of data entry, of course; it was chosen merely to illustrate keyboard entry. The data could also be clocked into each buffer in bit-serial, character-serial form, for example, which is a standard output format.

The three registers connect in parallel to the read-only memory through a buffer, which provides an interface between the bipolar access circuits and the MOS ROM. Under the control of steering counter 2, the output of one register at a time is switched in sequence into the ROM.

After the characters have been typed on the keyboard, steering counter 2 enables storage register 1 to supply ASCII signals to the ROM. Simultaneously, steering counter 3 connects column 1 of character 1 of the display to ground. At the same time, steering counter 4 instructs the ROM to interpret the six-line ASCII code at the ROM input and provide the proper outputs on the seven horizontal lines of the LED display to write the first column of the character. If H is the first character, the ROM would provide outputs on all seven lines, and these would be transmitted via transistor drivers to the LED matrix.

This action continues through columns 3, 4, and 5,

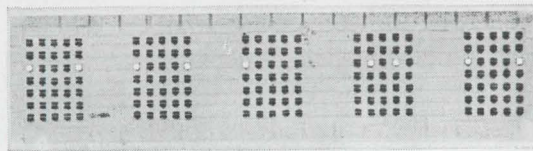
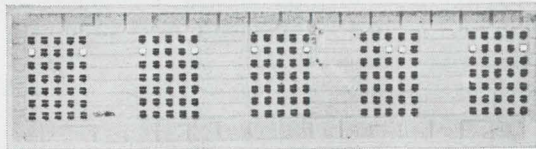
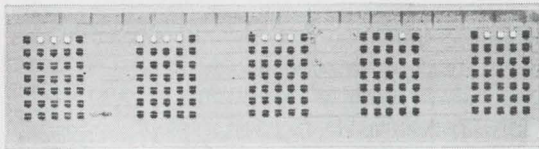
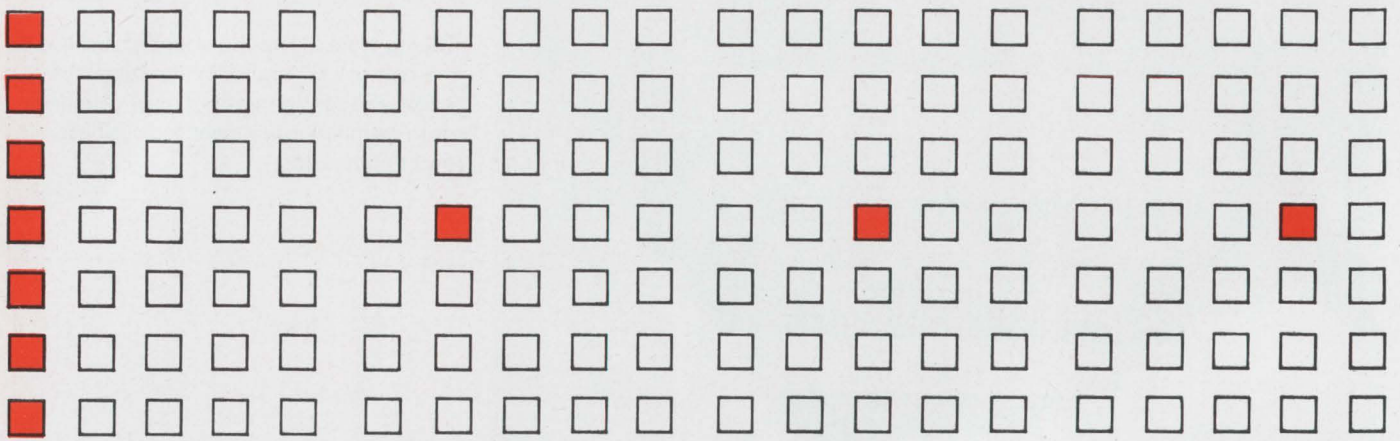

Vertical. When display is longer than about six characters, vertical strobing is preferable to horizontal. In vertical strobing, an entire row of the display is energized as data signals are applied to the columns. Photos here show a complete vertical scan and the result as seen by the viewer: the characters ABC48.

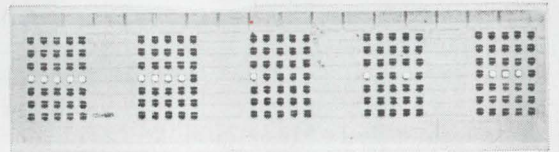

Externals. System for horizontal strobing uses standard IC's. Data from keyboard is stored in registers, released to read-only-memory for decoding, and finally transferred to the LED's; all this is done under clock control.

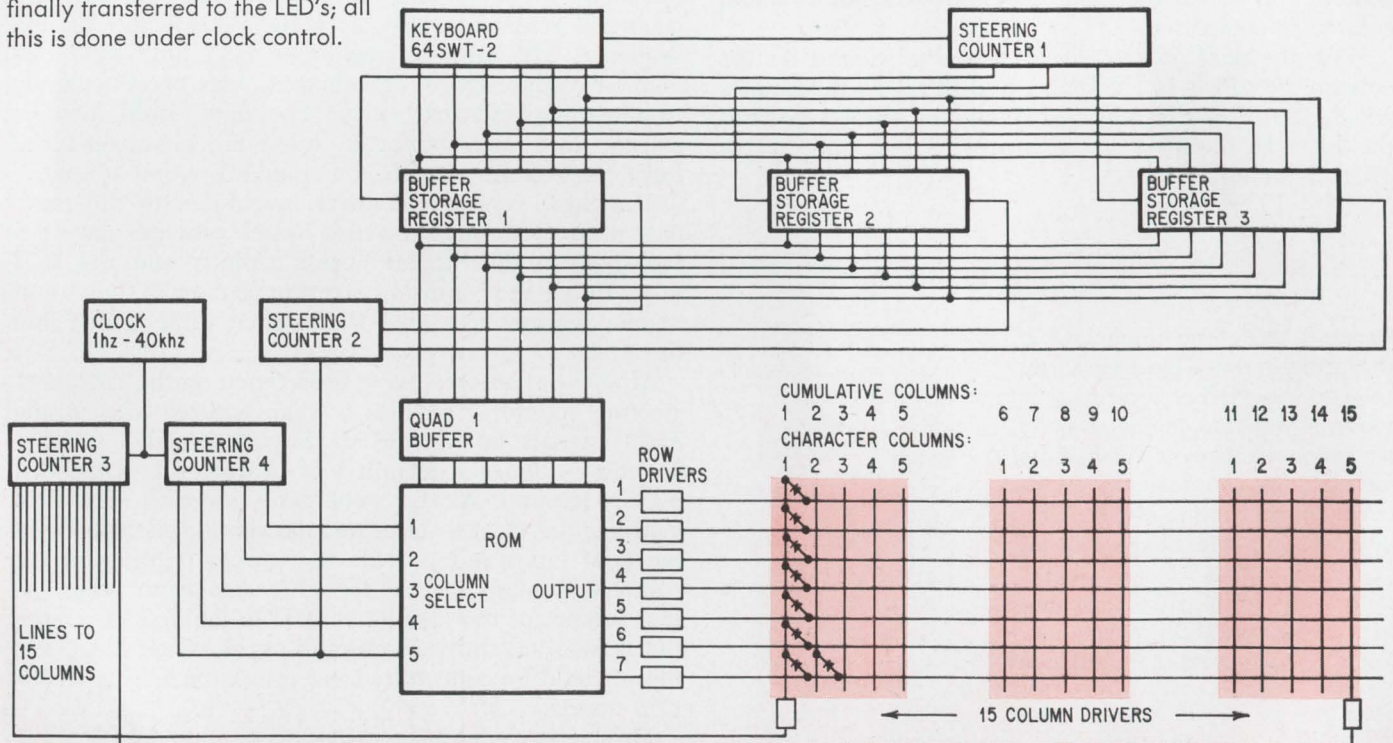

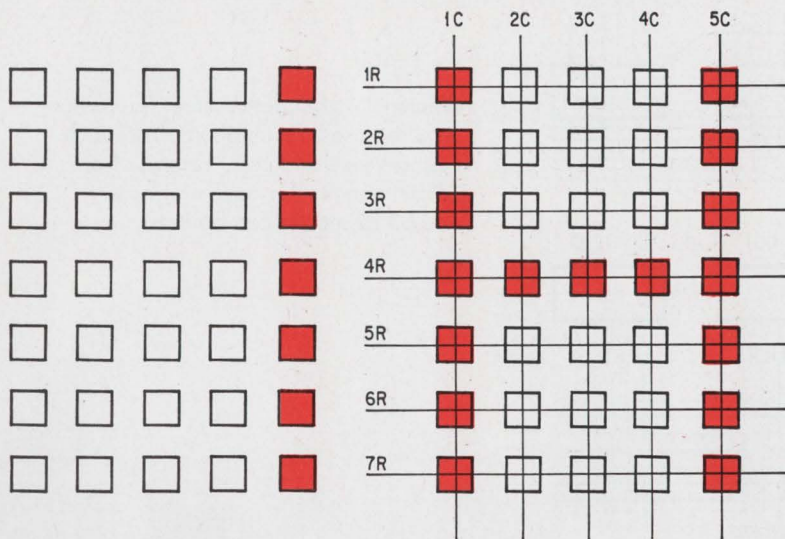

Horizontal. In the simplest form of strobing, columns of LED's are energized in sequence from left to right as the appropriate rows are energized in synchronism. Diagrams show sequence for one character as columns 1, 2, 3, 4, and 5 are strobed. Diagram at far right shows the composite effect observed by the viewer: the letter H.

thereby writing the rest of the H. Then, without delay, counter 3 moves to column 6 of the matrix—the first column of the second character. At this point, counter 4 recycles; it triggers counter 2 to select the next storage register as the input to the ROM, and returns to the interpret-first-column instruction. The ROM then provides the outputs for lighting the proper LED's in column 6 of the matrix. This procedure continues through column 15—the last column of the matrix. Counter 3 returns to column 1 and the routine starts again.

The ROM decodes instructions for punctuation in addition to alphanumerics. It can also skip characters to provide spacing.

The number of characters in the horizontally strobed display operated by a single ROM is limited by the peak current requirement of each diode. This is because the on time, or duty cycle, of a single diode is set by the number of columns, or characters, in the display. There is no provision for local storage in the display, and unlike cathode-ray tube phosphors, the diode has no persistence (rise and fall times are only a few nano-seconds); light is emitted from the diode only during the electrically activated interval. Thus the peak current is nearly equal to the average current per diode needed for the desired light level times the number of columns; for the three-character display, this might be 5 milliamperes times 15 columns or 75 ma.

Two factors operate to lessen this peak current by about one third: the eye tends to see pulsed light as brighter than a constant light source of equivalent power, and the luminous efficiency of LED's is higher at higher drive currents. A practical upper limit to peak LED current is about 100 ma as a result of the current crowding phenomenon: the high current tends to crowd under the metal anode contact of the diode, and the emitted light is therefore concentrated there too, where the opaque metal shields it from the viewer's eye. It follows, then, that only five or six characters can be driven effectively by the horizontal strobing method. In the future, as LED's are improved, this number of characters will increase as the luminous efficiency increases (and the peak current decreases).

When the display must be longer than half a dozen characters, Hewlett-Packard recommends vertical, or row-sequential, strobing. Here, the number of rows stays constant at seven (for a five-by-seven array), therefore the duty cycle remains fixed at $\frac{1}{7}$ regardless of the number of characters to be displayed. With the available speeds of ROM's and current-steering circuits, as many as 1,000 characters can be driven from a single ROM. The diagram at bottom of next page is representative of several available vertical strobing schemes; each 35-bit (five-by-seven) display uses a 35-bit memory.

As with all dynamic display methods, a clock is used

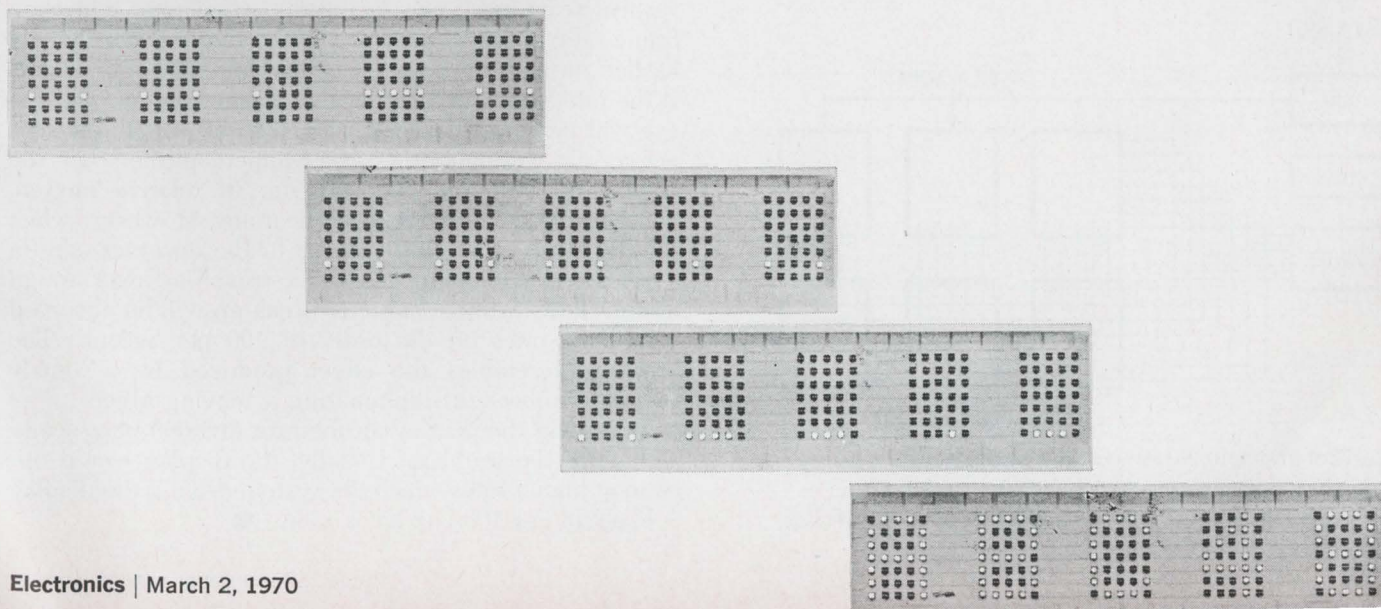

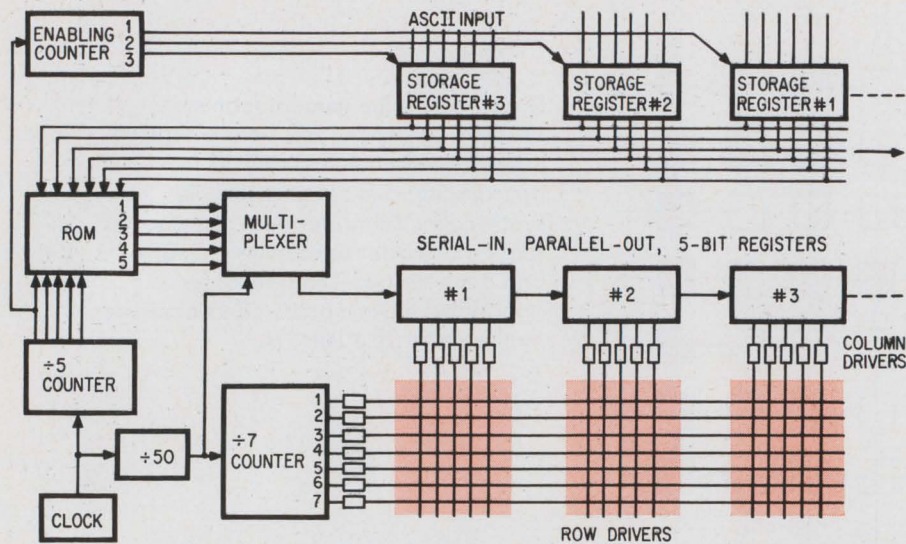

Efficient. A complete system for vertical strobing uses a multiplexer to reduce memory size and cost. Instead of a 35-bit memory for each character, five-bit memories can be used.

to synchronize the operation. The ASCII-code input to the ROM selects the character. The ROM can then load the memory cells, either bit-sequentially or row-sequentially. As in the horizontal case, the ROM converts the code format at the input to the character format at the memory. After each memory cell has been loaded the counter rolls the information in the memory into the columns of the display, row by row. The memory-stored characters are repetitively circulated to refresh the display.

From this basic operational mode, one can develop a large number of driving schemes, all with the valuable features of a constant duty cycle of about 15%. The system shown above has been implemented at Hewlett-Packard. Again, all of the circuitry is commercially available. The ROM's used by H-P were National Semiconductor's SK0001 and American Microsystems' S8163. The extensive development and manufacturing activity in memory-IC technology promises very low prices for the components. At present, the circuits for a five-character display run about \$30 per character in reasonable volume.

The basic timing in the vertically strobed system shown is provided by the system clock and may be as high as 100 kilohertz. Character storage efficiency is obtained by storing the characters in ASCII code form in the input storage registers. A steering counter syn-

chronizes the availability of a storage register with the incoming character signal. Since the rate of sampling of the storage registers is very fast compared with the rate of keyboard-entered data, the next available register will become available while the character input signal is still on the lines. (The circuitry for storage register synchronization with the keyboard pulses isn't shown.) The divide-by-five counter slaves the steering counter to the clock.

As in the horizontal strobing case, the storage registers are sequentially sampled to provide an input to the ROM. However, a difference does exist; the ROM output is multiplexed to exploit its speed relative to that of the human eye to load all of a single row of information into the serial-in, parallel-out five-bit character registers. Note that the five-bit register has been used to replace a 35-bit register in the basic version shown below. With the completion of the associated row-access circuitry through the row driver and the simultaneous output of all of the five-bit registers, a row is lighted. At this time the storage register again provides a bit-parallel, character-sequential input to the ROM; the ROM bit serially, character serially loads row 2 information into the five-bit registers; the five-bit registers are dumped in parallel into the display synchronous to the row 2 driver excitation; row 2 lights, and the sequence continues to write a complete character.

An important consideration in both horizontal and vertical scanning is the strobe rate, similar to television frame rate, of the display. A lighted diode is continually flashed on and off, once every display strobe, or frame. If the rate is low, say less than 50 flashes per second, the eye will perceive flicker. An increase to, say 100 flashes per second will make the flicker imperceptible when the display and the observer are not in relative motion, which holds true for most applications. However, when the display is in motion relative to the observer—say in a vehicle that is vibrating or is travelling over rough terrain—a disturbing character break-up will be observed with flash rates on the order of 100 per second. The break-up resembles the effect produced by a slowly flashing strobe light illuminating a moving object.

Increasing the display strobe rate to 1,000 per second eliminates the problem. Usually, the display would operate at higher rates, since the system driving the display is likely to use 100-khz clock rates. ●

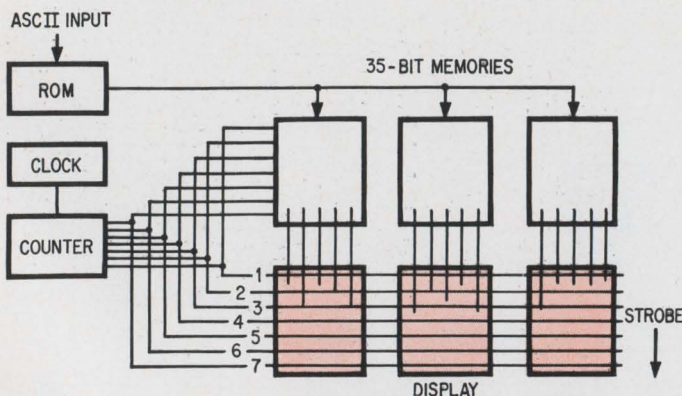

Vertical principle. In vertical strobing, decoded information from the read-only memory is stored and released to columns of the display on a row-by-row basis.

DAMON ANNOUNCES...

A new 7-pole monolithic crystal filter line that surpasses those previously available in shape factor and spurious mode suppression. Provides performance comparable to the highest state-of-the-art currently available with discrete filters - yet incorporates all of the inherent advantages monolithics have over conventional multi-component configurations. Now Damon provides the best of both worlds: critical performance, superior temperature characteristics, improved aging, small size, and significantly lower price. All are available in hermetically-sealed metal cases within miniature rectangular packages ranging in size from 0.080 cu. in. to 0.274 cu. in. Immediate off-the-shelf delivery of evaluation quantities. Damon also offers a wide variety of computer-assisted designs, but these take a little longer. Damon/Electronics Division, 115 Fourth Ave., Needham, Mass. 02194, Tel: (617) 449-0800.

The second generation in Monolithic Crystal Filters.



"STANDARD" 7-POLE MONOLITHIC CRYSTAL FILTERS					CASE "A" 0.274 cu. in.	CASE "B" 0.080 cu. in.
Model No.	6457MA	6457MB	6458MA	6458MB		
Center Frequency:	10.7 MHz ± .7 KHz	10.7 MHz ± 1 KHz	21.4 MHz ± 0.7 KHz	21.4 MHz ± 1 KHz		
Bandwidth, 3 dB:	6 KHz min.	15 KHz min.	6 KHz min.	15 KHz min.		
Bandwidth, 60 dB:	18 KHz max.	40 KHz max.	18 KHz max.	45 KHz max.		
Ripple, Max.:	1 dB	1 dB	1 dB	1 dB		
Insertion Loss, Max.:	6 dB	6 dB	6 dB	6 dB		
Spurious Returns:	> 55 dB down	> 50 dB down	> 55 dB down	> 50 dB down		
Terminations (Resistive):	2.0 kilohms	5.1 kilohms	0.38 kilohms	1.3 kilohms		
Ultimate Atten.:	80 dB	70 dB	80 dB	70 dB		
Op. Temp. Range:	0°-60° C	0°-60° C	0°-60° C	0°-60° C		
Case Size:	"A"	"A"	"A"	"B"		



Segmented array simplifies external address circuitry required for numeric display, strobing permits time-sharing of logic and drive

Solid state display operates at low voltage and power; *R. T. Gill* of Monsanto finds the LED array's capabilities and readability make it highly suitable for counting applications

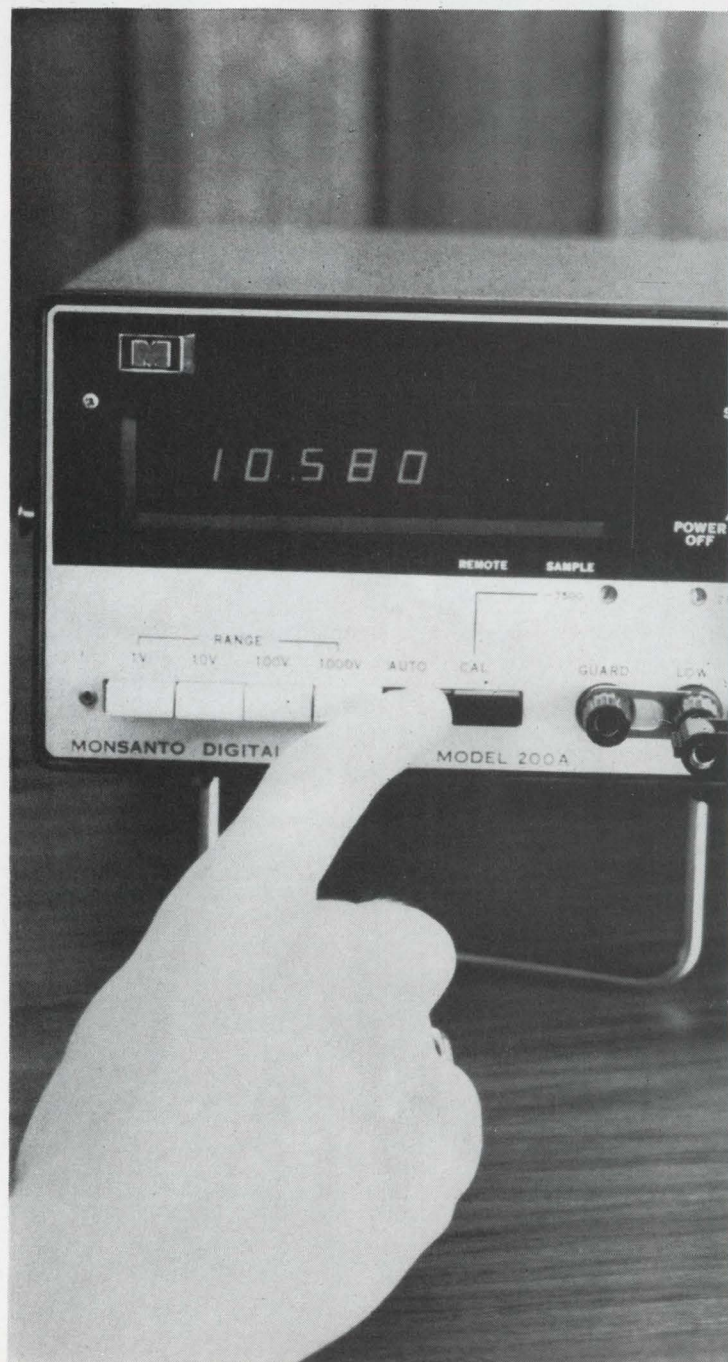

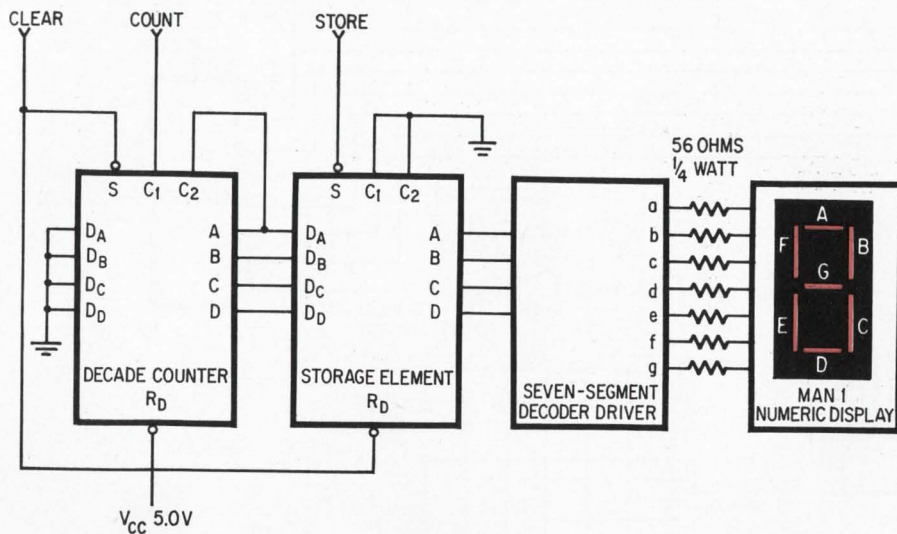

No strobe. When seven-segment LED numeric characters are controlled individually, each numeric requires these external IC's and resistors.

● One way to ease the information traffic jam that usually surrounds data displays is to simplify the display itself. This is the tack Monsanto has taken with its segmented light-emitting diode (LED) numeric display. By using only seven elements to describe the numeric character, both the pin connections and the circuitry for external character generation, addressing, and driving can be greatly simplified and, hence, reduced in cost. By contrast, the circuitry for a 27- or 35-element dot-matrix numeric display, whether it's composed of LED's or glow-discharge cells, would be more complex and expensive.

Monsanto's MAN 1 seven-segment LED display can be strobed. Thus, the numerics in a multicharacter display share the external circuitry—a further reduction. This external circuitry consists of readily available integrated circuits and discrete transistors.

In the MAN 1 the segments are separate gallium arsenide phosphate diodes mounted on a substrate with a common anode. The numeric character is 0.27 inch high and 0.187 inch wide. Each numeric is packaged individually with a dual in-line pin configuration.

Under development is a monolithic numeric character generator—all seven segments share the same GaAsP substrate. It should, therefore, require less power than the discrete-segmented MAN 1. Consequently, more digits can be strobed using the same power required

for the MAN 1. In fact, approximately eight times the number of monolithic digits can be strobed.

The hitch to the seven-segment format for LED's, of course, is that it's not readily adaptable to displaying letters as well as numbers. The ends of the segments would have to be tapered so that they more or less blend into each other, and it would be extremely difficult to cut brittle GaAsP in this shape. In the case of alphanumeric, then, Monsanto concurs with advocates of the dot-matrix approach. In fact, the company recently introduced the MAN 2, a five-by-seven matrix of LED's for use in displays that require alphabetic as well as numeric capability.

Nevertheless, in the many applications that need only a pure numeric display—in instruments such as counters—the segmented characters are well suited.

When the MAN 1 seven-segment light-emitting diode display is operated individually, it usually requires a decoder-driver, storage element, and decade counter for each character in the display, as shown above. The decade counter converts the binary data signals into four-line binary-coded-decimal signals, the required input code for the decoder-driver.

But, employing a separate decade counter, storage element, and decoder-driver for each character can be expensive as the display get longer. At present IC prices, it's more economical to use a strobing technique to time-share the control, addressing, and decoding circuits when the display is six characters or more.

For a multicharacter segment LED display, for example, the anode of each character can be energized in sequence as the cathodes of the proper segments of each character are energized, as shown at top of following page. To write the numerals 320, for instance, the BCD code for numeral three would be applied to the cathode-segment decoder at the same time as the anode decoder is instructed to start scanning. The proper anode driver then energizes the anode of the first character. Although the cathode segments for the numeral three (segments A, B, C, D, and G) are energized for all characters in parallel, only the first character lights because only its anode is energized. Then, the anode decoder switches to the second character, and the cathode decoder simultaneously supplies current to cathode segments A, B, D, E, and G and the numeral two appears on the second character. For the numeral zero, the anode decoder

Segmented. Primary application of seven-segment light-emitting diode display will be in counters and similar instruments in which a purely numeric display is needed.

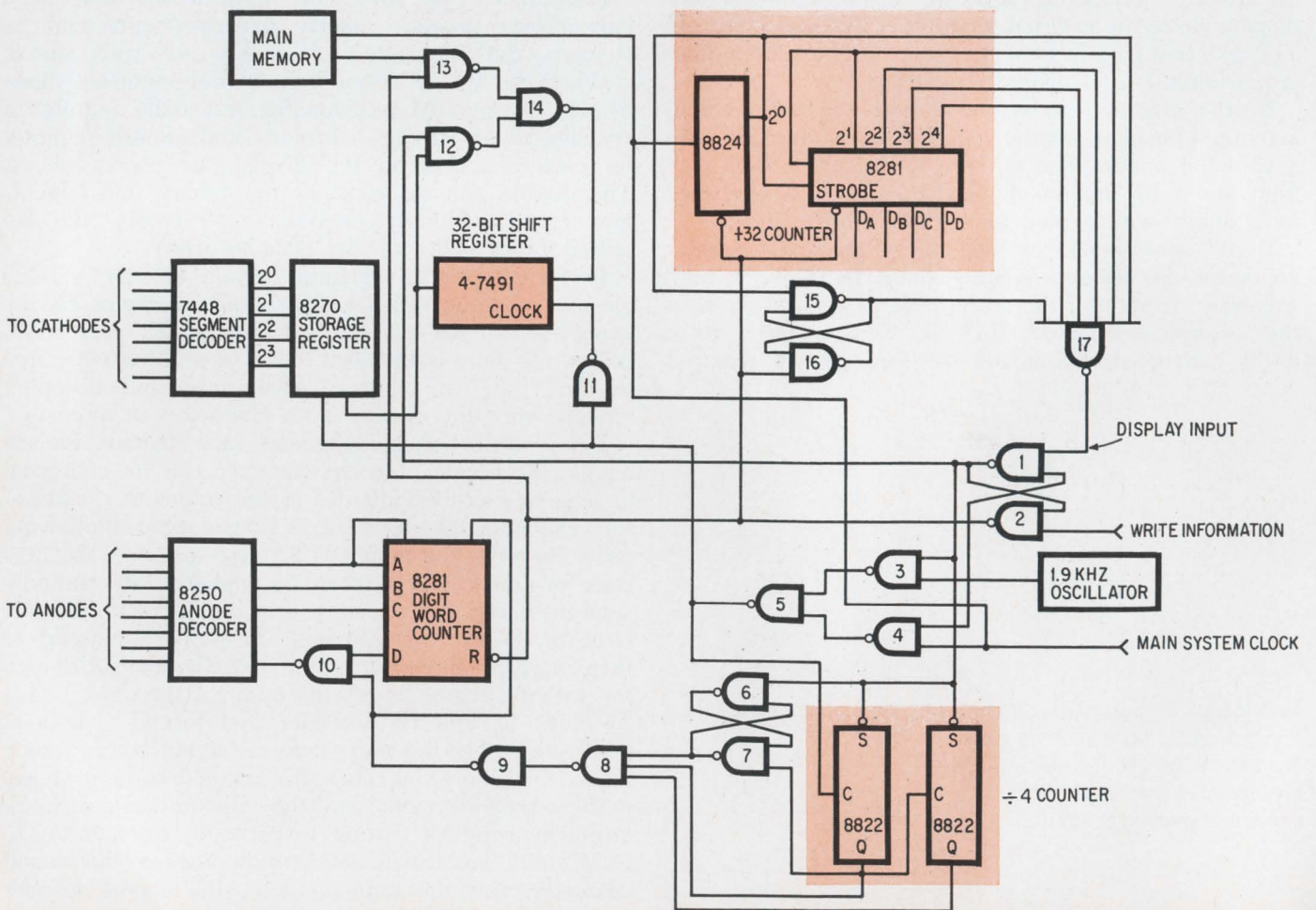
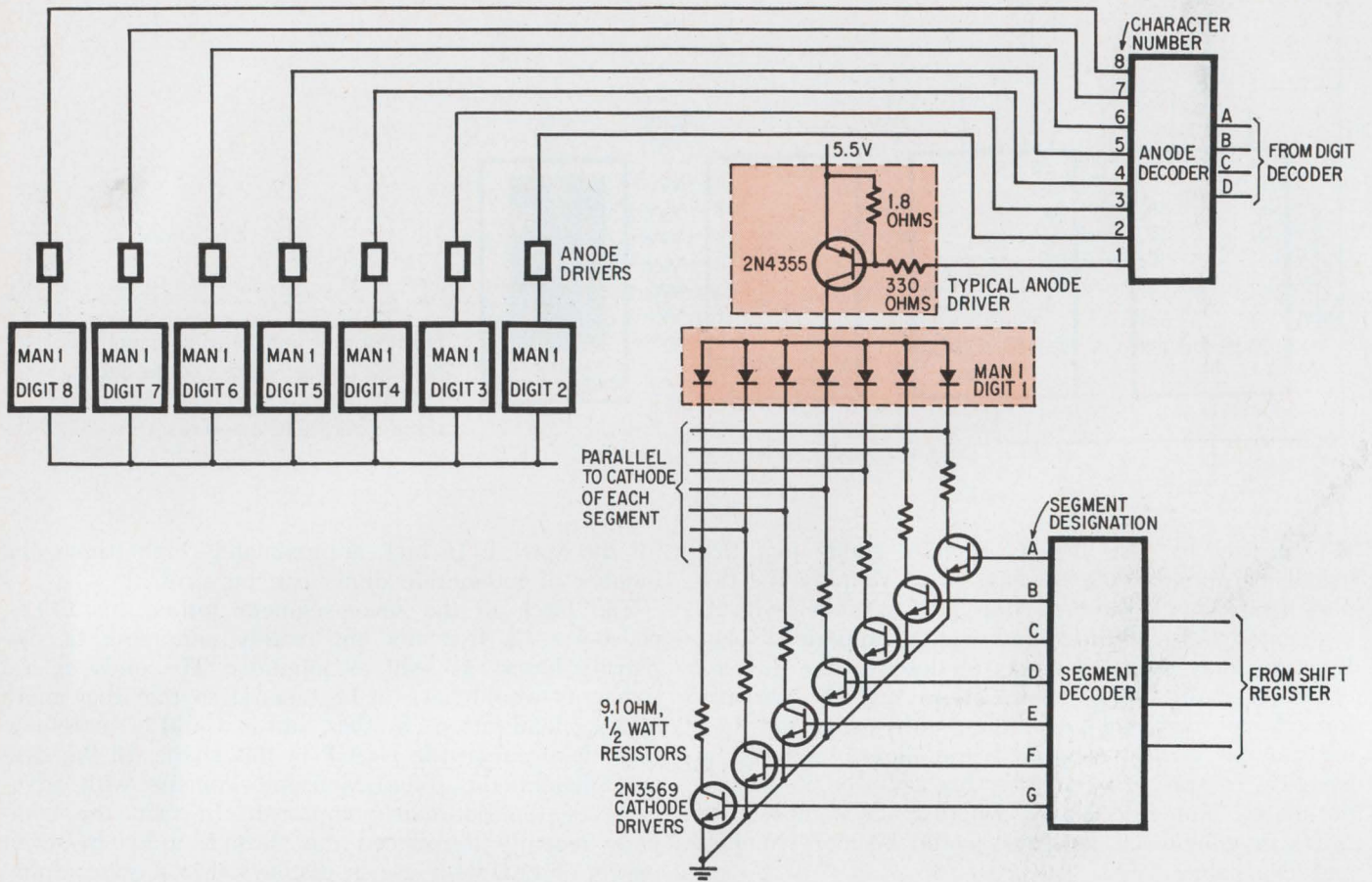

Share alike. Strobing technique shares external circuitry among the characters for greater economy. Anodes are energized in sequence as cathodes are energized in parallel.

switches to the third character, and the cathode decoder energizes cathode segments A, B, C, D, E, and F. To provide a flicker-free display, each character must be scanned at least 60 times per second. In general, the strobing rate for a particular display is n times 60, where n is the number of digits in the display and 60 is the frequency just above the eye's flicker rate. An internal clocking oscillator in the strobing circuit must operate four times faster than the above frequency because the cathode interrogating pulse must be four times faster for the four-line binary-coded decimal input.

Strobing necessitates discrete-transistor drivers to handle the high peak currents. Seven transistors are needed for the paralleled cathode segments, and one anode driver transistor is required for each character. For n characters, the peak current must be about n times the d-c current that would produce the desired brightness, since the human eye perceives the time-averaged brightness.

The diagram shown at top of the opposite page indicates how an eight-character display can be strobed. This system, incidentally, is derived from a scheme for strobing cold-cathode tubes developed by the Signetics Corp. Each numeric has its own anode driver, for a total of eight 2N4355 transistors. These transistors are turned on in sequence by the anode decoder for example, a Signetics 8250. The anode drivers must be able to handle the

Overall control. Anodes and cathodes of strobed system are operated by a combination of IC's that allows information to be loaded from the main memory of the instrument, and, then, transferred to the decoders.

peak current through all seven segments, which can total 480 milliamperes.

The cathodes of similar segments are connected in parallel to a cathode-driver transistor, type 2N3569. That is, all segments A have a common transistor driver, all segments B have another driver, and so forth, for a total of seven cathode drivers. The cathode-driver transistors must be able to handle the peak current for a segment, which is 80 ma for eight characters.

The character-writing procedure has essentially two phases: first, the display information is transferred from the main memory into the display circuitry; then, the display is scanned and addressed to write the numbers.

The anode decoder is operated by a digit-word counter, as shown at bottom of the opposite page. This counter counts pulses from the clock and, with every fourth pulse, sends a signal to the anode decoder, causing it to advance to the next character. Meanwhile, the four bits for the cathodes have been clocked into the storage register for the segment decoder in preparation for character writing.

A logic 0 at the write-information terminal starts the whole operation by allowing the four-bit words describing the characters to be transferred from the main memory of the instrument into the 32-bit shift register. Each character is described by a four-bit word.

Simultaneously, the write-information signal has started a plus-32 counter, which counts the main system clock pulses up to 32. When this count is reached, the display input (the input to gate 1) is set to 0, inhibiting any further counter advancement or shift-register loading. The count of 32 also turns gate 3 on, permitting the 1.9 kilohertz oscillator to activate the segment-decoder storage register. The register then can accept data from the 32-bit storage register and, thus, drive the segments. At the same time the oscillator also activates the divide-by-four counter so that the word counter and anode counter can drive the anodes.

The oscillator frequency of 1.9 khz was selected to give the necessary 60 times-per-second scan of the eight-character display. Doubling the length of the display to 16 characters is an easy matter, incidentally. It's done by adding another decoder and another set of drivers for the anodes. Also, in this case, the oscillator frequency must be doubled—to 3.8 khz—so that all 16 characters can be scanned 60 times per second. ●

Our new KBM-7 Koldweld® Machine is really fine. It cold welds wire from .0025" to .0126" . . . is hand-operated, with no other power required . . . and is easy loading. It butt-welds, to themselves and each other, practically all non-ferrous metals . . . copper, aluminum, nickel, etc. Like all Koldweld Machines, the KBM-7 produces a perfect metallurgical and mechanical butt weld in non-ferrous metals in seconds—with pressure

alone. No end preparation is necessary and exact end-to-end alignment is assured. With the KBM-7 joining the Koldweld line, there's now a Koldweld unit designed to butt-weld virtually all sizes of wire and rod stock up to half-inch diameter. For further information, write: KOLDWELD, Heintz Division, Kelsey-Hayes Company, Front Street and Olney Avenue, Philadelphia, Pa. 19120.

1. KBM-9
Range #30 AWG (.010")
—#15 AWG (.057")
2. KBM-5
Range #18 AWG (.040")
—#8 AWG (.1285")
3. KIH
Range—up to .187" dia. copper
—up to .25" dia. aluminum
Strip —Min. thickness .020"
—Max. width .750"
4. HRB
Range—up to .375" dia. copper
—up to .500" dia. aluminum
Strip —Min. thickness .030"
—Max. width 1.25"

Our newest Koldweld machine is the finest we've ever built.

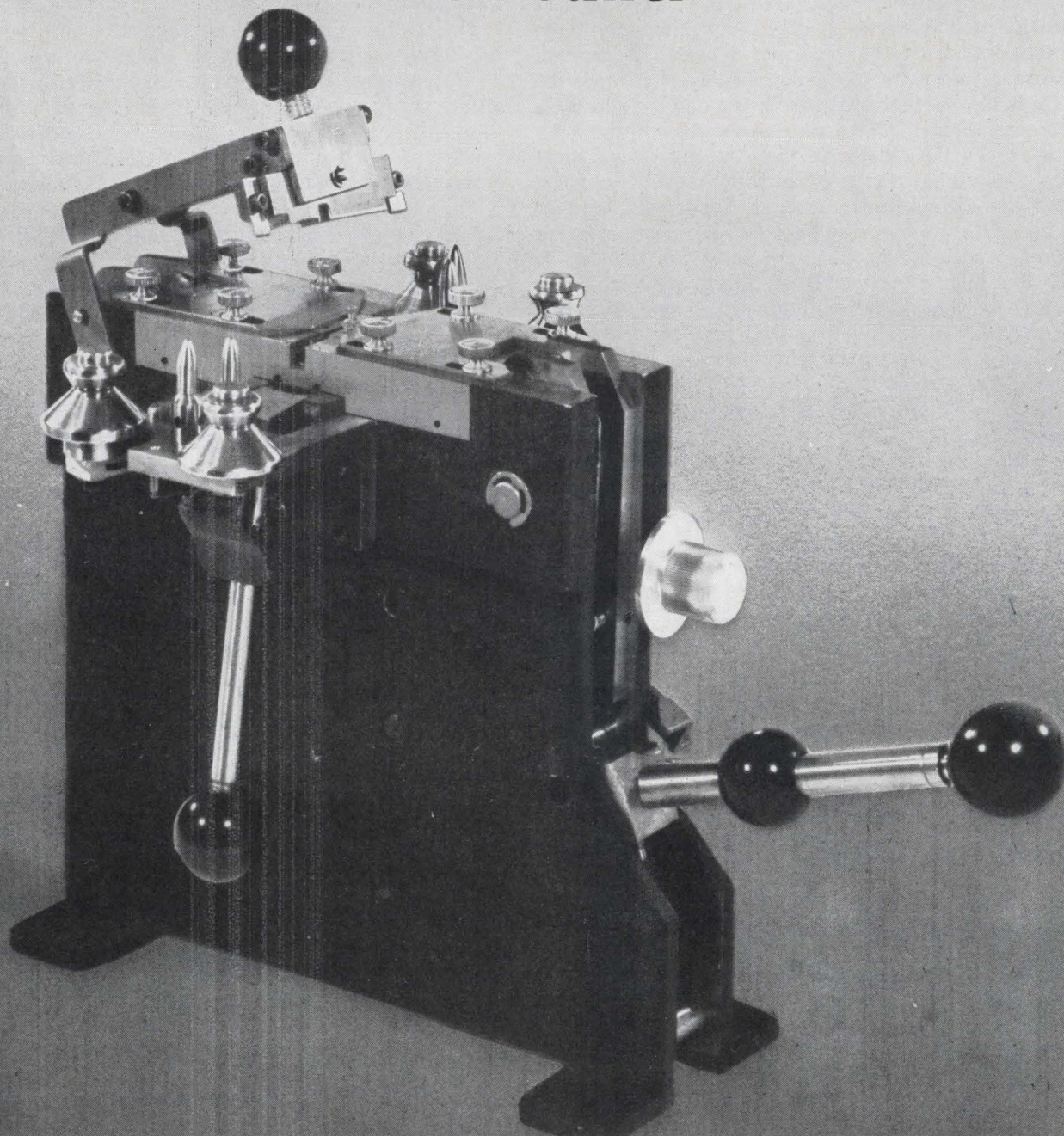

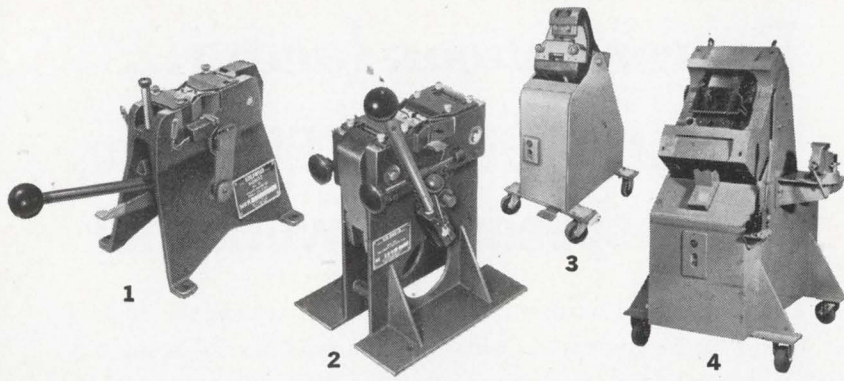

Lapwelding: We also supply lapwelders for welding a wide range of non-ferrous sheet and strip materials. Write for further information.

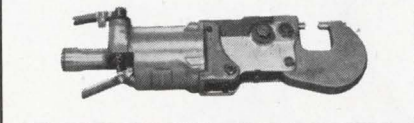

.0025" fine.

KH
HEINTZ DIVISION KELSEY-HAYES

For continuous lacing...

* that **CABLE-LACER** brake speeds the work too!

The experienced harness worker can quickly guide the hooked needle of the Gudebrod Cable-Lacer* across narrow break-out points between pins to grasp the loop. This is where work is speeded first. But then, the pressure of four fingers on the lacing break allows a swift, single pull for firm knot setting—further speeding the job. No need for wrapping around the fist—no need for a second pull. It all becomes a naturally fast procedure. What's more, the special Gudebrod lacing tape bobbins are helpful when all-hand tying seems required! Use Gudebrod Cable-Lacer, Gudebrod's Bobbins for improved accuracy and time saving.

*T.M. Union Special Machine Co.

Save money & time with **GUDEBROD SYSTEM "C"**

For continuous lacing Gudebrod offers a four part system to reduce your harnessing costs. The Cable-Lacer and Bobbins are the first two parts. Add to them Gudebrod's specially made, case hardened, extra long, wire holding pins and the Gudebrod Swivel-Tilt Harness Board Mount. The pins make wire threading easier and sharply reduce the need for re-dressing. The Gudebrod Mount brings any part of the harness within easy reach. Gudebrod System "C" makes harnessing go faster, cost less. Write for details. (For spot ties, ask about System "S")

Gudebrod Swivel-Tilt
Harness Board Mounts
available in several sizes

GUDEBROD
Electronics Division

1870—100 Years of Quality—1970

GUDEBROD BROS. SILK CO., INC. Founded 1870, 12 South 12th Street, Philadelphia, Pa. 19107



SAVE expediting expenses on small-signal transistor shipments

ITT Semiconductors, longtime manufacturer of popular small-signal transistor types, maintains a shelf inventory of reliable, metal-can units for most existing production designs. Our distributor stocks, together with our West Palm Beach backup, can give you "Next flight out" delivery on popular 2N numbers including 2369A, 706, 3724, 2222, 2906, and 929. Need JAN parts? We have them. Want a choice of TO-18, TO-52, or TO-5 packages? Easy. And when you take advantage of the ITT mixed-type quantity discounts, you'll never again settle for less than metal-can reliability. Let your expeditor worry about something else. We'll deliver the transistors.

We can save
you something!

semiconductors **ITT**

ITT Semiconductors is a division of International Telephone and Telegraph Corporation, 3301 Electronics Way, West Palm Beach, Florida 33407, Phone 305/842-2411. Factories in Florida • Massachusetts • England • France • Germany • Portugal • Australia

Just about everything you need for ordering wafers or dice

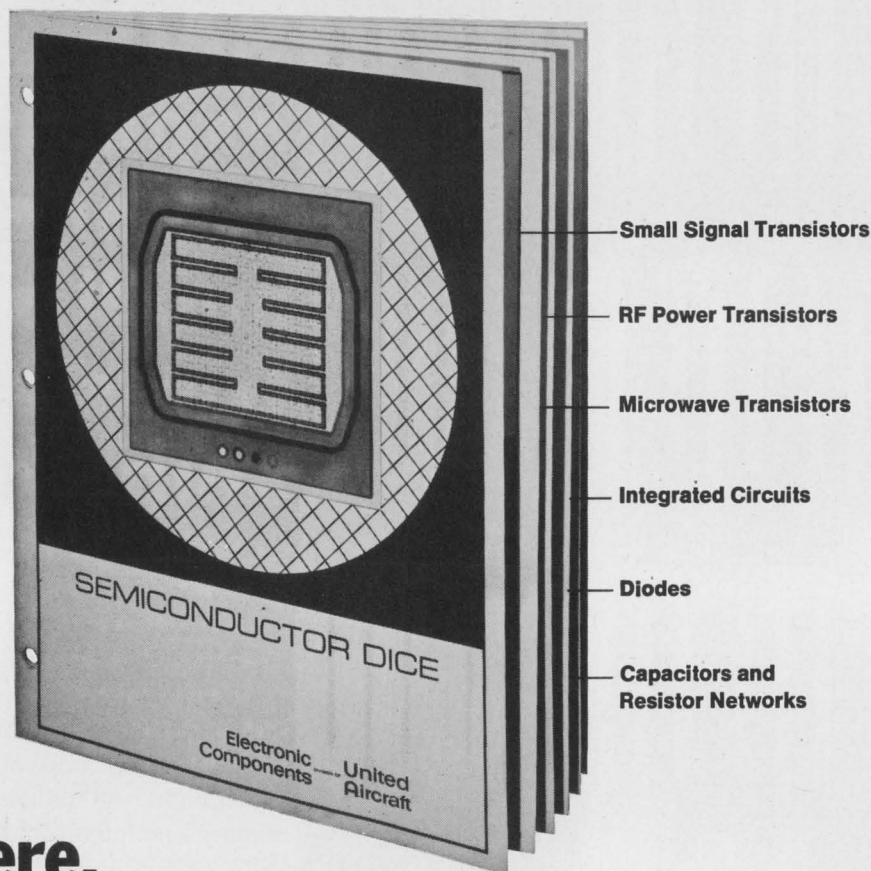

is in here.

In the new United Aircraft Semiconductor Dice catalog you will find complete information about all UA small signal transistors, RF and Microwave transistors, diodes, capacitors, and resistor networks. Complete specifications and geometries are given for all categories, and they are cross-referenced with regard to device types. Geometries of SUHL II Type and 5400/7400 Series integrated circuits are also given.

You can obtain a copy of the United Aircraft Semiconductor Dice catalog from any of the distributors or sales representatives listed below, or by writing directly to Don Tabbut, Marketing Dept.

Electronic Components DIVISION OF **United Aircraft**

TREVOSE, PENNSYLVANIA Tel. 215-355-5000 TWX: 510-667-1717

SALES REPRESENTATIVES

ALABAMA: Atlantic Component Corporation, Largo, Florida, (813) 584-8257
ARIZONA, Scottsdale: Engineering Sales Associates, (602) 945-5781
ARKANSAS: Hugh J. Daly Company, Tulsa, Okla., (918) 627-4159
CALIFORNIA, Los Angeles: Halbar Associates, (213) 387-8283
CALIFORNIA, San Mateo: Halbar Associates, (415) 349-4700
DELAWARE: Schibley Associates, Inc., Fairfax, Virginia, (703) 591-3008
DISTRICT OF COLUMBIA: Schibley Associates, Inc., Fairfax, Virginia, (703) 591-3008
FLORIDA, Largo: Atlantic Component Corporation, (813) 584-8257
FLORIDA, Plantation Isles: Atlantic Component Corporation, (305) 522-0306
GEORGIA: Atlantic Component Corporation, Largo, Florida, (813) 584-8257
ILLINOIS, Chicago: Carlson Electronic Sales, Inc., (312) 774-4812
INDIANA: Carlson Electronic Sales, Inc., Chicago, Ill., (312) 774-4812
IOWA: Carlson Electronic Sales, Inc., Chicago, Ill., (312) 774-4812

LOUISIANA: Evans & McDowell Associates, Dallas, Tex., (214) 351-9936
MARYLAND: Schibley Associates, Inc., Fairfax, Virginia, (703) 591-3008
MASSACHUSETTS, Winchester: Blake Associates, (617) 729-7890
MICHIGAN, Birmingham: J. C. Hofstetter Company, (313) 642-0590
MINNESOTA, St. Paul: Northport Engineering, Inc., (612) 698-3841
MISSOURI, St. Louis: Carlson Electronic Sales, Inc., (314) 991-0262
NEW JERSEY, Cherry Hill: Electro Component Sales, Cherry Hill, N.J., (609) 667-1894
NEW MEXICO, Albuquerque: Telemetry Sales Corporation, (505) 255-9192
NEW YORK, Fayetteville: Graydon-Sherman, Inc., (315) 637-9861
NORTH DAKOTA: Northport Engineering, Inc., St. Paul, Minnesota, (612) 698-3841
OHIO, Brecksville: Allen Nace Co., Inc., (216) 526-4323
OHIO, Dayton: Allen Nace Co., Inc., (513) 277-8215
OHIO, Galion: Allen Nace Co., Inc., (419) 468-7641

OKLAHOMA, Tulsa: Hugh J. Daly Company, (918) 627-4159
OREGON: Mr. Jon B. Jolly, Seattle, Washington, (206) 624-2152
PENNSYLVANIA, Pittsburgh: Allen Nace Co., Inc., (412) 561-3544
PENNSYLVANIA: Electro Component Sales, Cherry Hill, N.J., (609) 667-1894
SOUTH DAKOTA: Northport Engineering, Inc., St. Paul, Minnesota, (612) 698-3841
TEXAS, Dallas: Evans & McDowell Associates, (214) 351-9936
VIRGINIA, Fairfax: Schibley Associates, Inc., (703) 591-3008
WASHINGTON, Seattle: Mr. Jon B. Jolly, (206) 624-2152
WEST VIRGINIA: Allen Nace Co., Inc., Brecksville, Ohio, (216) 526-4323
WISCONSIN: Northport Engineering, Inc., St. Paul, Minnesota, (612) 698-3841
BRITISH COLUMBIA: Mr. Jon B. Jolly, Seattle, Washington, (206) 624-2152
CANADA, Longueuil, Quebec: John Barnes, United Aircraft of Canada, Ltd., (514) 677-9411

DISTRIBUTORS

ARIZONA, Phoenix: R. V. Weatherford, (602) 272-7144
CALIFORNIA, Anaheim: R. V. Weatherford, (714) 532-6741
CALIFORNIA, Glendale: R. V. Weatherford, (213) 849-3451
CALIFORNIA, Palo Alto: R. V. Weatherford, (415) 321-5373
CALIFORNIA, Pomona: R. V. Weatherford, (714) 623-1261
CALIFORNIA, San Diego: R. V. Weatherford, (714) 278-7400
FLORIDA, Palm Beach Garden: Industrial Electronics Assoc., Inc., (305) 848-8686
ILLINOIS, Chicago: Bodelle Company, Inc., (312) 468-1016
MASSACHUSETTS, Cambridge: R & D Electronics, (617) 868-6644
NEW YORK, Rockville Centre: All American Transistor Corp., (516) 536-7141
PENNSYLVANIA, Philadelphia: MIL-GRAY/Delaware Valley, Inc., (215) 228-2000
TEXAS, Richardson: R. V. Weatherford, (214) 231-6051
WASHINGTON, Seattle: R. V. Weatherford, (206) 762-4200

Plug Hewlett-Packard's 8699B solid-state RF unit into an 8690B Sweeper and you have the greatest octave-per-dollar value on the market. Like \$5200 for a sweeper package that covers five octaves with the flick of a switch. Instead of up to \$3000 more for a sweeper that requires as many as four plug-ins to do the same job. You also eliminate the usual \$1000 per tube cost of replacing BWOs. Result: a wide-range, high-performance source at a real cost saving.

A YIG-tuned transistor oscillator and fixed oscillator heterodyne at low level to minimize spurious signals and produce a highly stable, spectrally pure output in the 0.1 to 2 GHz range. HP's new wideband power amplifier,

a breakthrough in thin-film micro-circuitry, then boosts this heterodyne output to a working power of 20 mW. The YIG oscillator furnishes 10 mW output over the 2 to 4 GHz range. Harmonic content of the output is low and nonharmonics are typically more than 40 dB down. Residual FM is extremely low — less than 3 kHz, and sweep linearity is 0.5%.

This ultra broadband solid-state unit is the newest addition to a sweeper line that operates from 400 kHz to 40 GHz. The user-oriented 8690B mainframe provides start-stop, calibrated ΔF and marker sweeps which can be triggered or manually controlled, plus simple push-button selection of sweep and modulation

functions. Output leveling and modulation are PIN-diode controlled for optimum signal dependability.

Try the 8699B RF unit or any of the 22 other economical plug-ins in the 8690B. Owners of the 8690 can add the 8699B for \$3600. Your nearby Hewlett-Packard field engineer has complete information on this pace-setter for sweeper value. Or write Hewlett-Packard, Palo Alto, California 94304; Europe: 1217 Meyrin-Geneva, Switzerland.

HEWLETT  PACKARD

S W E E P O S C I L L A T O R S
04003

Sweep from 0.1 to 4 GHz with a single solid-state plug-in.

You'll save up to \$3000 now and another \$1000 on BWO replacement.

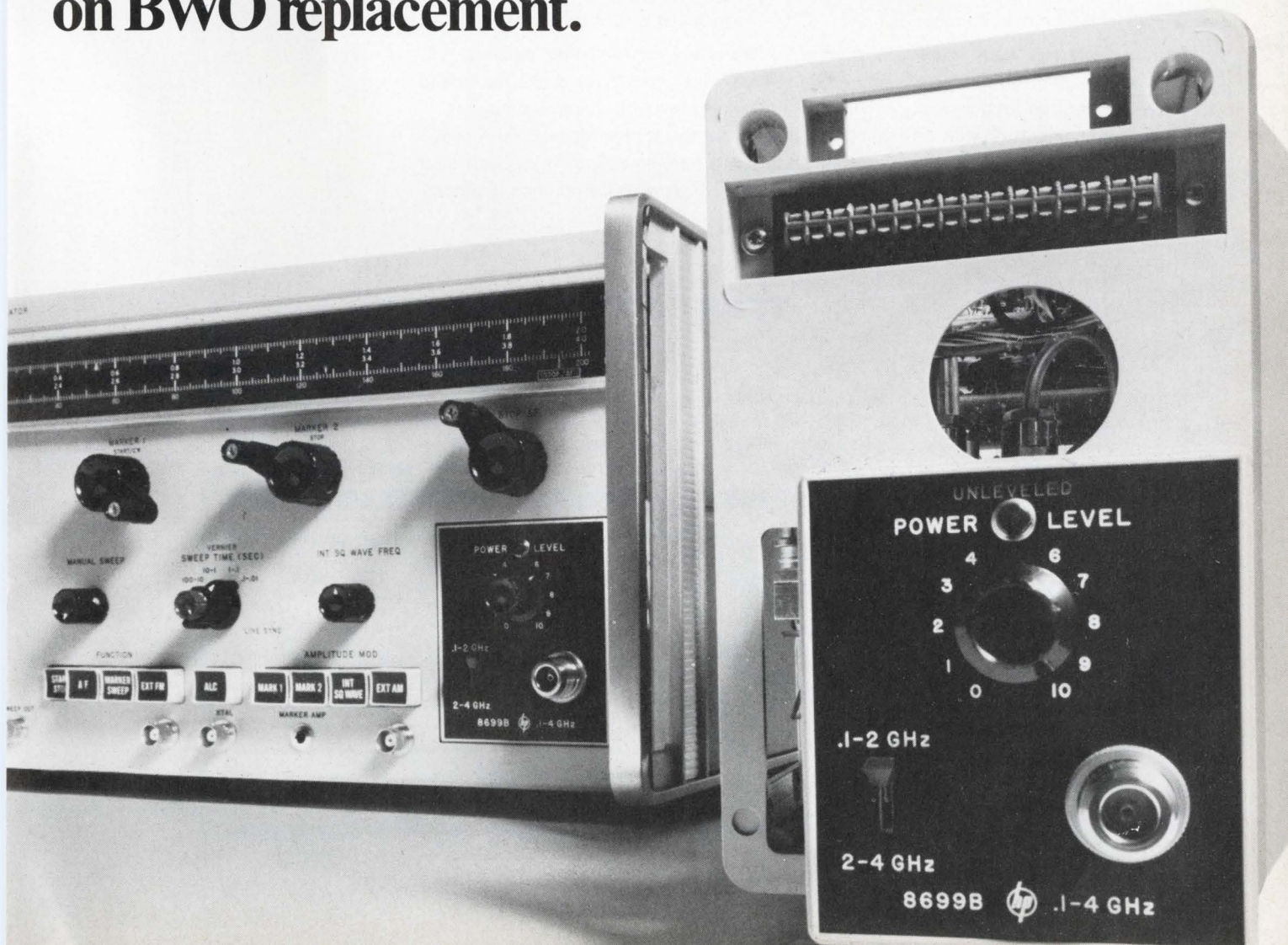

HERE'S HOW THE V-O-M SPECIALISTS GO DIGITAL

The principal problem with digital V-O-M's is that circuitry (rather than readability) limits their accuracy. Triplett has attacked that problem with characteristic thoroughness. The result . . . a totally new circuit (patent pending) in which there is virtually no internally-generated current from the V-O-M input circuit to affect measuring accuracy.

Triplett's Model 8000 digital V-O-M . . . the only V-O-M with this newly-developed circuit . . . offers a true DC accuracy of 0.1% of the reading ± 1 digit and an AC accuracy of 0.2% ± 1 digit. Triplett calls this "true accuracy" because it's the same accuracy you can achieve day-in and day-out, test-after-test, on any kind of circuit.

Quality-minded buyers will appreciate, too, the other job-matching features of Triplett's new digital V-O-M. Like . . . AC and DC voltage measurements from 1 mV to 1000 V in 5 ranges at 10 megohms input resistance; AC and DC currents from 0.1 μ A to 1000 mA in 6 ranges; 0.1 ohm to 100 megohms in 6 ranges.

Sounds like it was worth waiting for, doesn't it? It's ready for immediate delivery from your Triplett distributor at \$575 suggested USA user net. If you'd like the added convenience of an instant replay circuit that displays a previously-stored reading for on-demand comparison with an existing reading, ask for the Triplett Model 8000-A at \$630 suggested USA user net. For more information, or for a free, no-obligation demonstration, call your local Triplett distributor or sales representative. Triplett Corporation, Bluffton, Ohio 45817.



The World's most complete line of V-O-M's . . . choose the one that's just right for you

1. True 0.1% DC accuracy. Virtually no kickback current*. Allows voltage measurements in high resistance circuits at stated accuracy.
2. High AC accuracy with nearly perfect AC linearity and 10 megohm input resistance.
3. Low profile design in shielded case with modular construction for ease in use and maintenance.

*There is virtually no internally generated current from the V-O-M input circuit to affect measuring accuracy. (Patent pending on this feature).

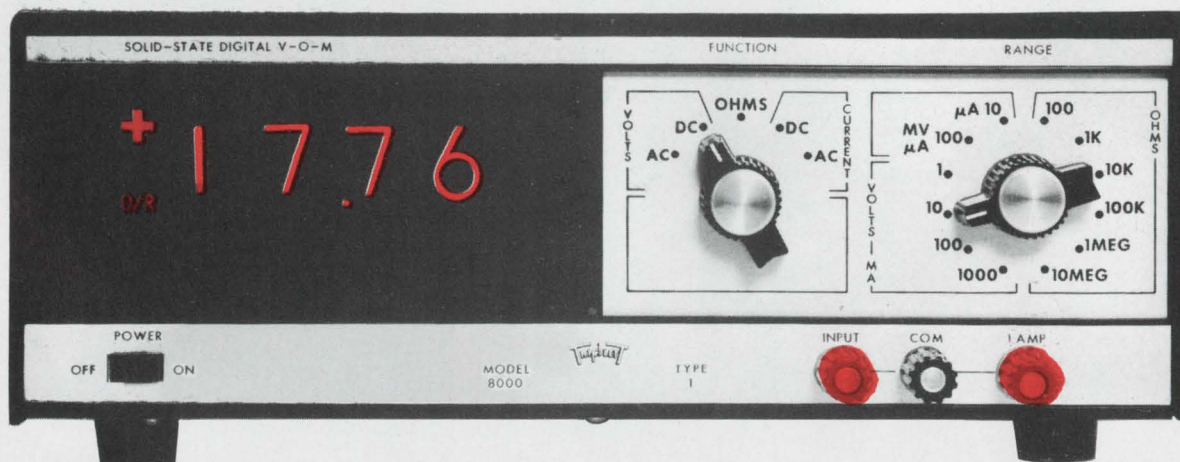

Semiconductor memories at a glance: What's here now, what's on the way

Claims and counterclaims are put in perspective to help you choose the best kind of semiconductor memory for your specific application

By Stephen Wm. Fields

Electronics staff

Proliferation is the word for semiconductor memories. Every integrated circuit manufacturer, it seems, wants to get into the act; lured by the prospect of a vast computer-age market, they announce new memory IC's almost daily. To complicate the situation, as the large companies like Texas Instruments, Motorola, and Fairchild have been developing memory product lines, many of their engineers and marketing people have seen their chance to grab a piece of the action. They've struck out on their own, establishing small companies to produce semiconductor memories exclusively.

So today there are no less than 18 companies making or planning to make some form of semiconductor memory. This active and competitive situation has led to an unending stream of claims and counterclaims of the biggest or fastest or most inexpensive memory.

The equipment or system designer who will use these products is understandably in a state of confusion. Should he go with metal oxide semiconductor bipolar technology, multichip or completely monolithic? When will these devices be available in quantity? What will access time and cost per bit be at the time the system is ready for production?

In spite of the confusion, it's possible to put things in order and draw some conclusions. Most semiconductor memory houses will agree on these points:

▶ An acceptable semiconductor re-

placement for the large mainframe computer core memory hasn't yet arrived, and won't until 1971 at the earliest. Although devices that could be used in mainframes do exist, they are not available in volume and at a price where they would become a serious contender for the mass memory market.

▶ Nevertheless, semiconductor memories are already replacing cores in smaller computers—those with 10,000-bit capacity or less—and in peripheral equipment.

▶ Bipolar circuits will be used when access time of 100 nanoseconds or less is needed. MOS circuits will be used for access time of 300 nsec or more. The best device for the middle range is anyone's guess.

Summing up the view of most manufacturers, Jerry Moffitt, manager of semiconductor memory programs at Texas Instruments, doesn't look for much large equipment to be introduced this year or next with semiconductor memories; there will be only "a few" systems in 1971 with semiconductor random-access mainframe memories. He doesn't expect any big influx until 1974 or 1975 "because the bulk of the market is at 1 to 2 microseconds. This is the speed at which cores go best—they're not pushing the state of the art. We have to offer something besides technology for people to change."

On the other hand, the overall feeling in the industry is that semi-

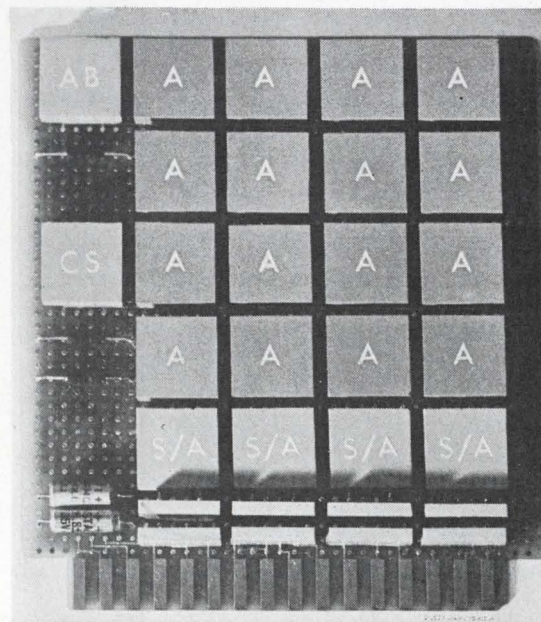

Modular. Cogar's "Mind Jogger" memory subsystem has a highly modular organization. Modules labeled A contain the memory arrays. AB represents an address buffer, CS is the chip-select module, and S/A indicates sense amplifiers. Capacitors and terminating resistors are located at the bottom of the card.

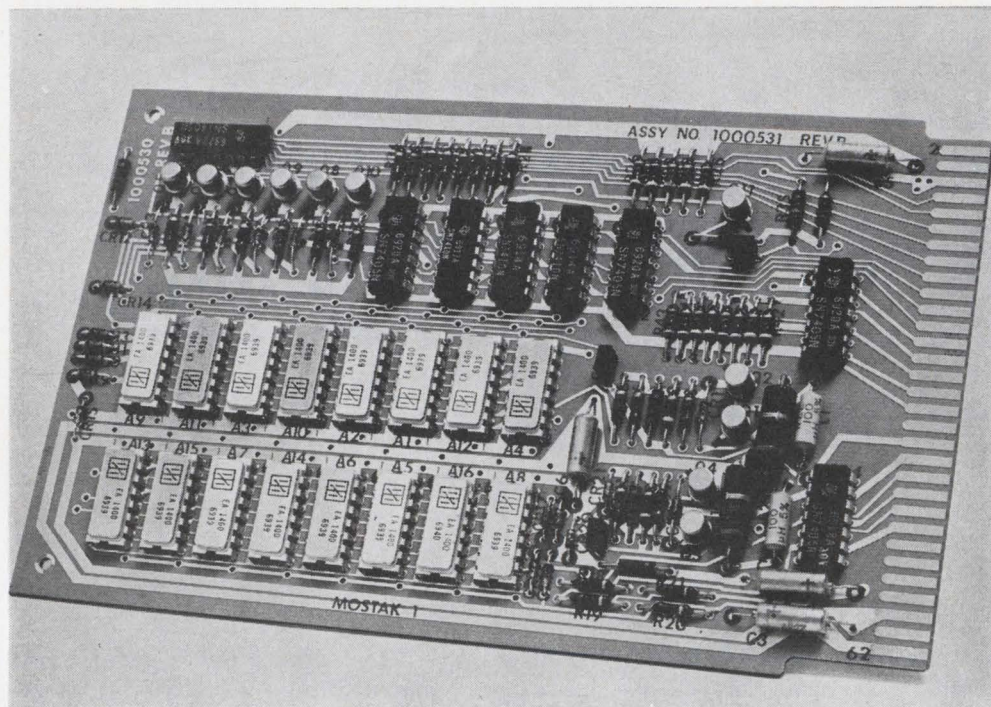

Subsystem. A popular approach to the semiconductor memory market is to manufacture a complete memory subsystem on a card, suitable for use as a scratchpad or buffer memory. The Mostak I random-access read-write memory, for example, manufactured by Electronic Arrays Inc., employs 16 MOS chips, each with 128 bit capacity.

conductor memories should soon, if they haven't already, start replacing cores in smaller systems, those that require 10,000 bits or less. Gordon Hoffman, who has responsibility for Mostek's applications and device characterization, is looking for semiconductor random-access memories in computer peripheral equipment in the next year. Hoffman includes terminals, data sets, and information retrieval systems requiring a small amount of memory—say 1,000 bits—in this category. The latter is a region where cores can't compete, Hoffman says, because a 1,000-bit core memory might cost \$500 to \$600, but a semiconductor RAM costs less. For example, the Intel Corp. is selling its model 1101 fully decoded 256-bit RAM with an access time of one μ sec for \$40 in unit quantities. Thus, a 1,024-bit semiconductor RAM can be bought today for \$160, and in quantity the price drops to \$94.

Semiconductor RAM's won't start making a dent as a core replacement in the minicomputer market until 1973, Hoffman predicts. However, the dissociation of bulk storage and mainframes of computers could hasten the onset of semiconductor RAM's. Although Hoffman hasn't yet seen any machines being designed this way, he expects the mainframes and bulk-storage units to be "spread around the machine,"

and this could trigger a faster introduction of semiconductor RAM's—first in the mainframes and then in the bulk-storage section.

Source of confusion. Much of the confusion that memory users face is due to the fact that, in general, semiconductor memories are available in three speed categories: high speed (10 to 60 nsec), medium speed (100 to 400 nsec) and slow speed (500 nsec to 2 μ sec). And, because all of the semiconductor memory manufacturers don't agree on what is fast and what is slow, there is a gray area surrounding each category. Further complicating the problem is the packaging terminology. Memories can be bought as individually packaged chips or memory elements, as multichip modules, or as complete systems or cards.

There are three companies—at the present time—who are sticking to memory systems only. These are the Cogar Corp., Advanced Memory Systems Inc., and Semiconductor Electronic Memories Inc., (SEMI). For its first memory product, Advanced Memory Systems has staked out a narrow sector of the memory market: very high-speed memory cards.

AMS's ECL memory cards are probably the fastest units available, with an access time of 15 nsec. The cards contain two types of devices—a 16-bit bipolar ECL memory

element and a storage-support chip that contains the buffers and card and chip selection circuits. Four types of cards are available—a 32-word-by-eight-bit and a 32-word-by-nine-bit memory, each of which is either transistor-transistor logic or ECL compatible. According to Jerry Larkin, vice president of marketing at AMS, the market for these high-speed memories is not as a replacement for mainframe cores, but rather for replacement of scratchpad, small buffers, and discrete registers.

Complete and competitive. Presently, high-speed bipolar registers, says Larkin, cost about \$1.50 to \$2.00 per bit, not including the support circuits. AMS's units are complete and are competitive at about \$2.00 per bit in quantities of 100, he says. Also included on the card are termination resistors and bypass capacitors. By the end of March, AMS expects to have a 4,096-bit memory card on the market. This will also be a high-speed ECL memory, but will use 64-bit chips instead of the 16-bit chips. Also in the works is a 256-bit chip for even larger systems.

Cogar is also sticking to memory systems, but, unlike AMS, is using multichip modules rather than cards to make up the system. Cogar's basic memory line will include a system for each of the three types of memory markets—

slow, medium, and high speed. The high-speed line will employ bipolar chips—to interface with ECL circuitry—and have an access time of 40 nsec. Each card will contain about 9,000 bits. William Taren, Cogar's marketing manager, says that sample cards will be available in April and expects to be able to deliver in quantity by July.

The medium-speed line also uses bipolar chips and interfaces with diode-transistor logic or TTL circuits, and up to 18,000 bits are available on a card. Access time is 125 nsec, and these too will be available in quantity by July. The slow speed, or "cost/performance" line as Taren prefers to call it, employs MOS chips, has an access time of 250 nsec, and interfaces with DTL or TTL circuits. With this system, up to 144,000 bits can be put on one card. Volume production for the MOS system won't begin until November. The price, including decoding circuits, but not the power supply, is 30 cents per bit for the high speed, 12 cents per bit for the medium speed, and 5 cents per bit for the cost-performance line.

Use two active modules

SEMI's approach is to use two active modules: a storage module with two bipolar 64-bit by two-word memory chips and a support module with two bipolar chips that contain the decoder, sense amplifiers, memory-address register, and eight current drivers. All memory systems, which SEMI will begin shipping in August, consist of different arrangements of these two types of modules on a printed circuit card. The systems will range in size from 1,000 to 9,000 bits and will have an access time of 200 nsec. Prices will range from about 20 cents per bit for a 128-bit-by-eight-word system to 10 cents per bit for a 1,024-by-nine unit.

SEMI's storage element is now bipolar; but a 256-bit MOS storage chip is in the works. According to Don Winstead, marketing vice-president, "The prime reason for going to MOS is to double the bit capacity and keep the chip size the same—so we can cut our costs." But, he stresses that bipolar is a known technology, and SEMI, being in a start-up situation, doesn't want to take many risks, so the

initial thrust will be in bipolar.

SEMI, like Cogar, is using a flip-chip bonding technique to attach the chips to a substrate, making up a module. The technique, called liquid-phase joining, is based on IBM's solid-logic technology. And, again like Cogar's, the assembly process is entirely automated.

Beam-lead bonding. Companies that make memory modules include Motorola and Computer Microtechnology Inc.; both employ beam-lead bonding as opposed to the system makers who use flip-chips. Motorola's memory is an 8,192-bit module employing 256-bit MOS storage arrays, ECL bipolar driver chips, and a laminated beam-lead interconnect scheme. The module consists of six packages; four contain eight each of the 256-bit memory chips, plus one bipolar array-selection circuit. One of the other packages contains the bipolar sense amplifier and the digit driver arrays, and the sixth package holds two chips that make up the bipolar decoding circuit. Access time is about 125 nsec.

The unit will be available about mid-year in evaluation quantities. Volume production is slated for late 1970 or early 1971. Roger Helmick, manager of digital IC planning at Motorola, projects a price of about 15 cents per bit in 1971, which, he believes will make it competitive with cores in buffers and scratchpads. Further down the road, Helmick expects the price to drop close to 5 cents per bit in 1972 and close to 2 cents in 1974, prices that should compete with those of mainframe core memories.

Computer Microtechnology's module is a 4,094-bit unit on a ceramic substrate that is about 1.5 inches square and has an access time of 150 nsec. It incorporates 22 chips—four bipolar 1-out-of-8 decoders, three bipolar dual-sense amplifiers, and 16 MOS storage arrays of 256 bits with partial decoding. Sample quantities are available now, and the price is about 50 cents per bit. But, Dave Conrad, vice president of marketing at CMI, says that the price should drop to about 1.5 cents per bit by mid 1972. Conrad doesn't see high volume for his memory in mainframes until 1972 or 1973, although a market exists now in computer peripherals and instruments.

Motorola has introduced three memory elements to date. One is in the ECL family (MC1036, 1037), with a 17-nsec access time; the other is a TTL unit (MC4004, 4005) with an access time of 35 nsec. Both of these bipolar components are coincident-select 16-bit read-write devices. The third product is a 64-bit (16 by 4) MOS unit designated the MC1170, which includes all decoding and read/write circuitry on the chip. Motorola is also working on a 64-bit TTL memory component, estimated to be a few months away from production.

Helmick maintains that any or all of these smaller components are applicable to minicomputers and computer peripheral equipment, and could challenge cores in small systems because the price is in the 15-cent to 25-cent per bit range for buffers and scratchpads, essentially the same as core memory cost for similarly sized systems. In addition, Helmick points out, semiconductor memory speed is five times faster than cores and their readout is nondestructive vs. a destructive readout from cores.

Without decoding. To date, TI has introduced a 256-bit MOS RAM without decoding on the chip but with two-dimensional address—a product that has been on the market more than a year. Its sole TTL memory component is a 16-bit-by-one-word unit that has been available for about a year. There's also one memory component in the firm's ECL 2500 family—a four-word-by-two-bit device. For these one-chip-per-package components, semiconductor-memory manager Moffitt says TI can deliver possibly a couple of orders of 10,000 to 100,000 units per month. But, it will be 1971 before TI has a significant capacity in multichip packages. These will range in size from 4,000 to 8,000 bits.

For the future, Moffitt sees integration of bipolar and MOS components as the way to go rather than pursue these as individual technologies. TI's moves in this direction are not unlike Motorola's in that the firm is using MOS storage elements, bipolar drivers, and beam-lead interconnects. TI forms beam leads using an approach that is slightly altered from that of Bell Labs, but more conventional than the beam-lead laminate used in Mo-

torola's 8,192-bit memory module.

Mostek has preliminary data sheets on seven products after being in business just about eight months. One of these is the MK4001P, a 256-bit-by-one-word MOS RAM without decoding, much like the TI chip. Mostek was scheduled to deliver its first parts in January or early February, and by the end of the year, Hoffman predicts the firm will be able to ship 100,000 parts per month. This is an aggregate figure for all lines.

Fairchild Semiconductor's announced devices include a 16-bit TTL RAM, a 64-bit TTL RAM, a 64-bit MOS device, and a 128-bit memory module that is made up of eight 16-bit chips bonded face down to a 1-inch-square ceramic substrate, and has an access time of 25 nsec. According to Fran Krch, marketing manager for standard MOS and memory products, other devices to be shortly introduced are a 256-bit MOS unit and the other is a 256-bit bipolar RAM that Fairchild has been supplying to Burroughs for Illiac 4. Called the 4100, it is organized as 256 by one and has an access time of 70 nsec. Pricing for the 4100, according to Krch, will be in the "10 cent-a-bit area in 1970; but, this should drop to below 5 cents as soon as volume production—around 100,000 units—allows."

Exotic isn't final word

Krch says that large, exotic chips are not necessarily the answer. The winner in the memory market will be "the guy who is building the big one at a high price, but who also has a smaller device that he can sell in volume to compete with cores—the most economical chip is one level down from the top." In the bipolar area, the top might be a 1,024-bit unit, and for MOS, it might be 2,048, Krch says, but it is still too early to tell.

Intel is another company that is playing it close. Its present products are a 64-bit bipolar RAM with an access time of 60 nsec, and a 256-bit MOS RAM with an access time of one nsec. Both units are priced at \$40 in unit quantities. Intel will soon introduce a 256-bit bipolar unit that will have an access time of about 70 nsec and will be half the price per bit of the 64-bit unit. Also down the road

is a 1,024-bit MOS memory that will come in two versions; 1,024 by one with an access time of 150 nsec, and 512 by two with a 300 nsec time.

Against multichip. Robert Graham, Intel's marketing vice president, is predicting a cost of 1 cent per bit for the 1,024-bit MOS RAM by 1971. Graham doesn't favor the multichip approach. There is no cost advantage; he says it would be cheaper, for example, to put the 1,024-bit unit in a plastic package—"and this is not far away," he adds.

Raytheon, on the other hand, is counting on beam-lead multichips to produce large arrays. Presently, Raytheon has two bipolar random-access memory chips—a 16-bit and a 64-bit chip. Raytheon's scheme is to beam-lead 16 memory chips to a ceramic substrate. Thus, a 1,024-bit array can be fabricated now, and when the company's next device—a 256-bit bipolar unit with an access time of 25 nsec—becomes available in July, a 4,096-bit array will be tops. Marketing manager Marshall Cox points out that beam-lead chips offer several advantages in building memory arrays. First, because the chips are etched apart instead of being scribed, die yield is higher and so the cost per chip is lower. Secondly, beam-leading lends itself to automatic assembly of arrays, and this also will help reduce costs. And the costs, Cox says, will be on the order of 8 cents per bit in 1971, 4 cents in 1972, and 1.5 cents in 1973, in large quantity.

Cost not sole factor

But, Cox is quick to point out that cost won't be the sole factor. "Computer architecture is changing," Cox says, "and the memory is being dispersed throughout the main frame so that instead of finding 50,000 bits in one place, you'll find 4,000 here and 4,000 there—memory elements will be replacing some logic circuits. With this change, it won't matter if memory costs 2 cents, or 5 cents, or 10 cents per bit because it will still be cheaper than logic."

Among the companies that manufacture MOS memories, Electronic Arrays is taking two approaches: MOS elements and MOS cards. EA now has 128-bit and 64-bit memories on the market, and a 256-bit unit with an access time of 300

nsec will be introduced soon. A memory card that will employ 16 units of 128-bits—organized as 512 words by four bits—with an access time of 800 nsec will also be introduced soon. The memory elements provide flexibility to the memory system designer while the cards offer a package—complete with clock and interface circuits—for the small (under 10,000 bits) memory.

Signetics, American Micro-Systems Inc., and Intersil are also in the MOS random-access memory field. Signetics has a 256-bit, 700-nsec memory that it is supplying to National Cash Register. AMI has a 512-bit unit with an access time of 150 nsec, and a forthcoming 128-bit device that can be electrically altered to form a 128-by-one, or 64-by-two, or 32-by-four memory. Intersil's memory is a 256-bit unit with a 350-nsec access time.

RCA currently has two semiconductor memories on the market. One is a 16-bit complementary MOS device with an access time of 15 nsec and features a quiescent power dissipation of 100 nanowatts. Regular 16-bit p-channel MOS devices dissipate about 50 microwatts. The other is a 16-bit bipolar ECL circuit which has an access time of 6.5 nsec. Both devices have been in production for about a year. According to Frank Rohr, market planner for digital IC's, RCA intends to concentrate on what it calls performance-type-memories—either low power dissipation or high speed. Next on RCA's list is a 64-bit complementary MOS memory with an access time of 50 nsec and 150 nanowatts of power dissipation for August introduction.

It appears that the newcomers to the memory business have a more advanced product line than the "old guard" IC houses. Companies like Cogar, AMS, Mostek, SEMI, Intel, AMI, and EA, have concentrated their efforts in the memory area. Still, the largest contracts to supply semiconductor random-access memories for computer mainframes are the Fairchild-Burroughs and NCR-Signetics deals—although NCR is reportedly evaluating other firms and is also developing its own 256-bit RAM in an effort to qualify more suppliers. A question remains, however; who does the market belong to? The answer: there's enough for everyone.

Photomechanical reproduction of precision parts is our business

We invented it!

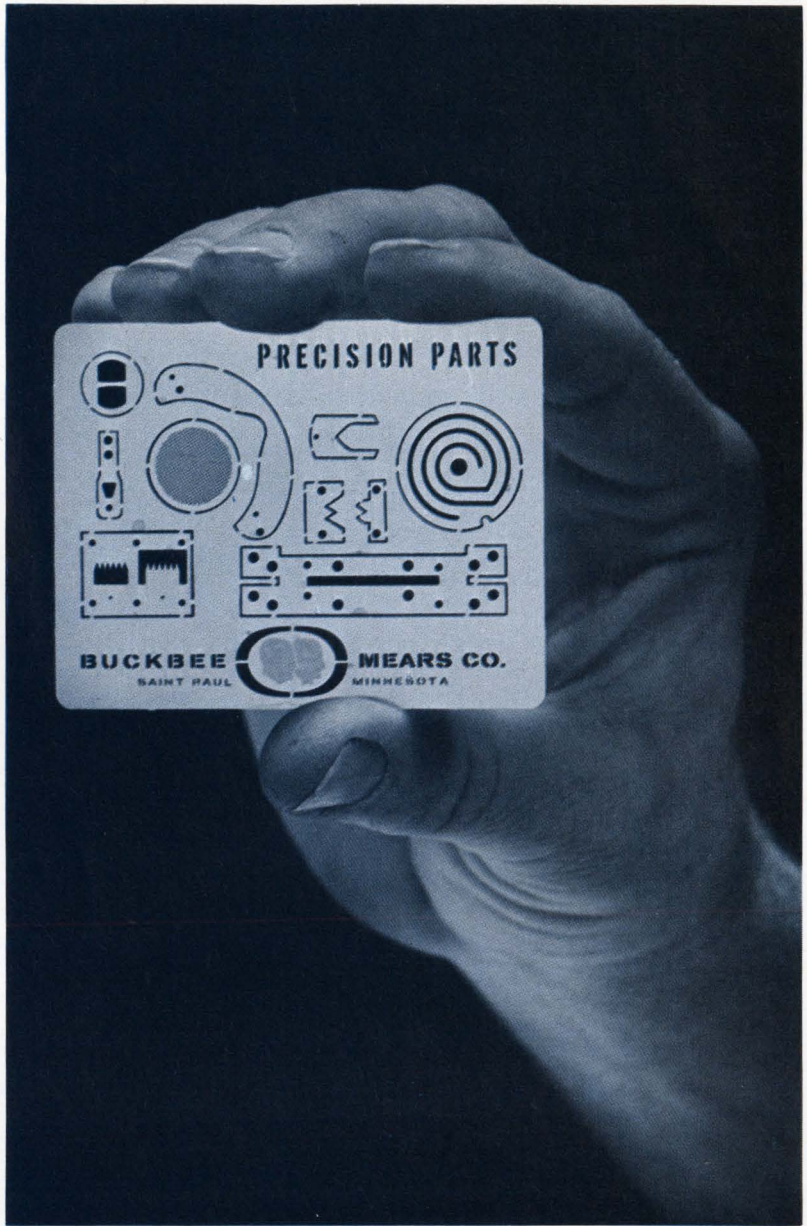

We began precision etching of metal and glass parts for the military during World War II. Today we're the world's largest producer of photo etched metal, glass and electroformed parts. Our new computer-directed automatic plotter is accurate to .001" or better, and it can draw in an hour what would take a draftsman days to do. It's economical, too, because there are no costly dies to make.

METAL ETCHING: We etch round, square, oval or straight holes or lines to tolerances of $\pm .0001$. Currently we are producing shaver grills, hemispheric domes, springs, micro component parts and curved surfaces too complicated for die stamping. We etch mesh, precision circuitry, core loading mats and print out rollers. More than 70 materials have been etched in our plant.

ELECTROFORMING: Our mesh screens go down to four million holes per square inch with accuracy.

Line width tolerances of ± 2 microns are common. Typical production ranges from five to 2,000 lines per linear inch. We electroform copper, nickel, silver and gold. A few standard products include evaporation masks, pin hole apertures, micro-mesh sieves, electron microscope grids, optical wedges, zone plates and a variety of micro-miniature parts.

GLASS ETCHING: We use the same photomechanical techniques in glass etching to provide calibrations and other configurations to tolerances of $\pm .0001$. Straight and cross rulings, calibrated dials, concave and convex reticles, scales, prisms and encoder discs are some of the items we produce in volume.

FREE SAMPLE CARD: The metal card shown on the illustration above contains samples of etched parts we can produce. If you would like one, drop a note to Bill Amundson, Industrial Sales Manager, on your letterhead.

PRECISION METAL AND GLASS ETCHING • ELECTRO FORMING • AUTOMATED DESIGN



BUCKBEE-MEARS COMPANY

SAINT PAUL, MINNESOTA 55101

Vehicle locator systems are set to find a strong new market

Electronics firms are readying systems for precise tracking of 'lost' police, taxi fleet, and transit authority vehicles; in some units, 'canned' digital messages free up voice channels

By Leon M. Magill and Peter Schuyten

Electronics staff

What's it worth to a police department, commercial trucker, taxi fleet owner, or transit authority to keep constant tabs on where each of its vehicles is and what it is doing? More than a dozen U.S. electronics companies and several consulting firms are betting that this kind of information soon will be considered indispensable to law enforcement, urban transit, public utility and commercial users. And they are developing vehicle locator systems (VLS) to meet this demand.

There are basically two types of VLS, or automatic vehicle monitoring systems as they are sometimes called: a proximity, or fixed-route approach, where buses, for example, travel on predetermined paths; and area surveillance, in which vehicles travel random paths.

Typically, fixed-route systems, such as that developed by Motorola's Communications division for the Chicago Transit Authority, employ electronic signposts, or roadside transmitters, that interrogate vehicles as they pass along the route (see panel p. 150).

Area surveillance, on the other hand, is more complex, and as such there are almost as many approaches to providing area surveillance VLS as there are companies in the field.

One of the most advanced techniques—now in the testing and hardware design stages—is the automatic vehicle monitoring system of the Hazeltine Corp. Based

on Hazeltine's pulse-ranging experience in radar beacon transponders for air traffic control and its work in identification - friend - or - foe (IFF) equipment, the Hazeltine VLS uses a transponder installed on each vehicle that automatically responds to an electronic "roll call" initiated by a control center. The center's transmitter radiates a periodic synchronizing pulse (every 1 to 5 seconds), and each vehicle transponder automatically responds in a preassigned time slot that can be as short as 1 millisecond. The roll call can be run off in as little as one second for 1,000 vehicles. A computer determines a vehicle's location by solving hyperbolic equations based on signals received at three or more

fixed stations—thus, trilateration.

The Hazeltine system, however, is designed to do more than provide a location fix—hence the name automatic vehicle monitoring. The coded pulse train from the transponder can contain additional information: the passenger count or a report on mechanical problems in a bus, for example, or a police car's availability for emergency calls. The 12 pulse positions in a time slot in Hazeltine's system permit use of 4,096 binary-coded messages, or 1,000 bcd messages.

The pulse patterns and pulse groupings used by Hazeltine in tests to date are considered proprietary. Says systems engineer Jack Cohen: "When you're receiving sig-

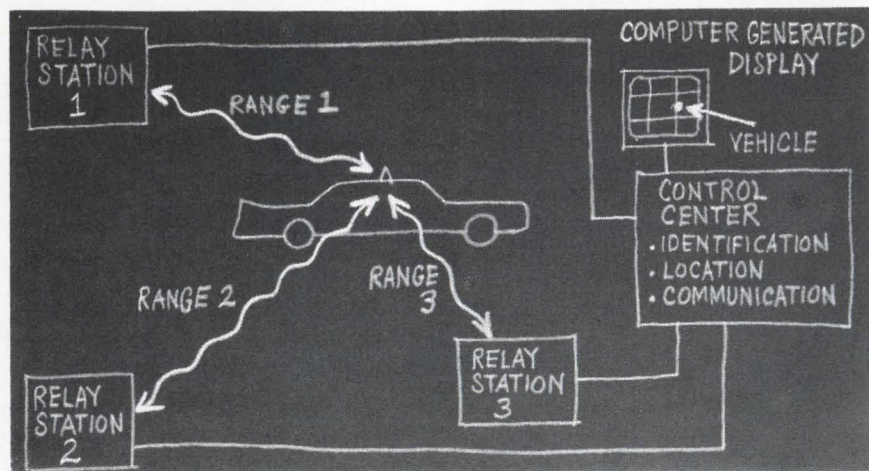

Auto finder. Trilateration is the key to vehicle location; station interrogation, auto response, and computer control sees that the job is done.

not just another calibrator... an AC voltage standard

(the first to 110 kHz)

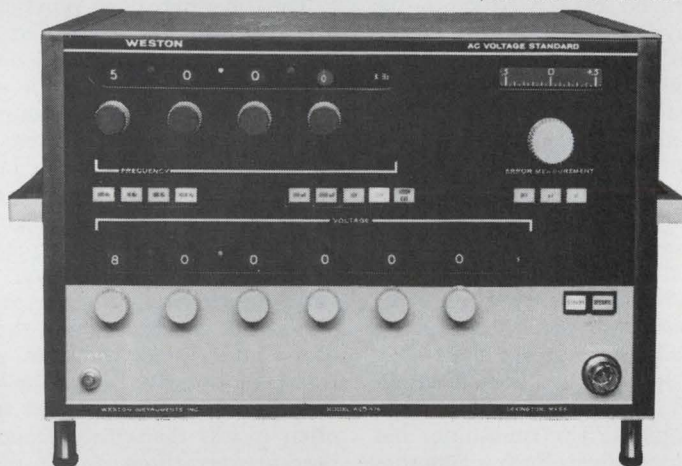

The **WESTON-LEXINGTON ACS-176 AC Voltage Standard** is the most accurate, most stable AC Voltage Standard produced.

Here, at last, is a laboratory instrument that combines the accuracy and stability of a primary standard with versatility and operating simplicity needed for the rapid, precision calibration of AC test instruments without external monitoring equipment. Wide voltage (0.1 μ V to 121 volts) and frequency (10 Hz to 110 kHz) ranges with in-line digital display provide broad test flexibility for use in production and incoming inspection. Direct indication of voltage, frequency, and % error simplify and speed operation while eliminating human error. Remote programming is available, including voltage and error measurement ranges, together with an error measurement output for data recording.

- 10 Hz to 110 kHz
- 0.02% + 2 μ V absolute accuracy of setting from 0.1 mV to 121 V (no need to worry about or look for additional adders or uncertainties; there are none)
- Direct indication of % error
- 0.01%/year amplitude stability
- Remotely Programmable
- Many other advanced features

Send for complete data and specifications on this extraordinary new instrument.

Weston Instruments Division,
Weston Instruments, Inc.
17 Hartwell Avenue, Lexington, Mass. 02173
Tel: (617) 861-9000; TWX (710) 326-0596

a Schlumberger company

WESTON®

COMPARE!

Check the features below against any other 100kHz AC voltage standard.

Unparalleled performance

The ACS-176 offers the best overall accuracy available (0.02% + 2 μ V to 20kHz over its full voltage range) and the best frequency temperature-coefficient characteristic in its field. An important plus is its capability for calibrating phase-angle voltmeters with 0.1° accuracy to 10kHz. And it is available with a data acquisition system (Series 710).

Unique features:

From its human-engineered panel design to its exclusive convenience and safety features, the ACS-176 offers:

- Transient-free, rapid-settling voltage selection.
- Large in-line numerical read-out for repeatable, accurate, frequency selection.
- In-phase and quadrature phase reference outputs for calibrating phase meters.
- Overload-memory circuit for safety.
- Totally fail-safe operation.
- Remote programming of ranges.

For the first time:

Now you can rely on a meaningful and useful *total* accuracy specification. Absolute Amplitude Accuracy, including: 90 day stability; all calibration uncertainties in traceability to NBS; all effects of noise, cycle-to-cycle instability, and distortion in calibrating average or rms-responding instruments; 0.1mV to 121V, all effects of line-voltage variation within the stated temperature limits.

1000 volt amplifier

Also available to expand these outstanding calibration capabilities to high voltage levels is the KVA-121 kilovolt amplifier. This all-solid-state add-on unit simply and conveniently extends the versatility of the basic instrument, providing full-range calibration voltages to 1000 volts from the *same* output connector.

See Us at IEEE Booth 2c 39-50

STABILITY & QUALITY

High quality capacitors unrivalled in the precision, dependability and compactness. Quality is recognized by ever wider use in measurement equipment, computers, and automatic controllers. "LEAF" the matter of capacitors to MATSUO ELECTRIC CO.

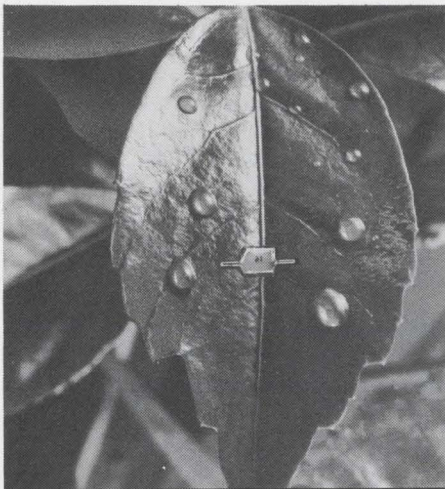

MATSUO

SOLID TANTALUM CAPACITORS FOR HYBRID ICs - "MICROCAP".

Specifications:

Operating Temperature Range: -55°C to $+85^{\circ}\text{C}$
Standard Voltage Rating: 6.3, 10, 16, 20, 25, 35 VDC
Standard Capacitance Value: .001 to 22MFD (E6 series)
Standard Capacitance Tolerance: $\pm 20\%$ (M)

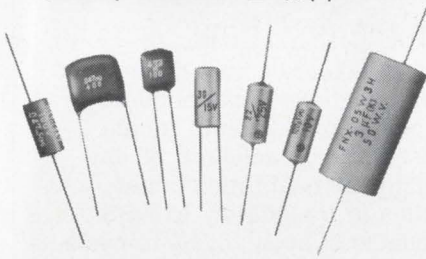

MATSUO'S other capacitors include:

Metallized Polyester Film Capacitor: Type FNX-H mylar wrapped.
Solid Tantalum Capacitors: Type TAX hermetically sealed in metallic case, Type TSX encased in metallic case and sealed with epoxy resin, Type TSL encased in metallic case and sealed with epoxy resin. **Polyester Film Capacitors:** Type MFL epoxy dipped, Type MFK epoxy dipped, non inductive, Type MXT encased in plastic tube, non inductive.

For further information, Please write to
Manufacturers and Exporters

MATSUO ELECTRIC CO., LTD.

Head Office: 3-5, 3-chome, Sennari-cho, Toyonaka-shi, Osaka, Japan
Cable: "NCCMATSUO" OSAKA Telex: 523-4164 OSA
Tokyo Office: 7, 3-chome, Nishi-Gotanda, Shinagawa-ku, Tokyo

nals in a jungle of concrete buildings, extensive testing—and only testing—can show the optimum pulse patterns in the face of multipath. Spread spectrum techniques and similar methods help, but you have to learn about multipath effects through experience."

Multipath can be desirable and, at the same time—a major source of

errors in the system. Without the multipath effect, the signals could not get down into the "valleys" between tall buildings in a city like New York. In one test conducted by the firm in New York City using three fixed stations, a van stopped at 10 checkpoints over a period of little more than an hour. The errors in location averaged 225 feet.

Ready to roll

Perhaps the closest thing to an operational vehicle locator system is one being built for the Chicago Transit Authority by Motorola's Communications division. Two months behind schedule because of a delay in the delivery of the CEPAC 4020 computer, the CTA system is expected to finally get rolling on March 12. The system is of the so-called proximity type, and as such, is restricted to a fixed route—the one traveled by CTA buses.

With this system, a dispatcher can immediately locate any bus equipped with the Motorola gear, and if need be, contact it by voice. In addition, each bus is equipped with an alarm system that overrides all other signals in case of an emergency.

Initially, 500 buses—those on the "owl," or night runs, will be equipped with the system. Along those selected routes will be electronic signposts—roadside transmitters—which send out 153-megahertz signals. The transmitter has a 300-foot range. Each signpost is assigned a discrete identification number—a 10-bit binary code that is stored in the signpost's location information generator. The continuously repeated coded message is converted into analog form, modulated onto the 153-Mhz carrier, and transmitted. Because the short signal requires little bandwidth, it can be sandwiched in between voice channels in the uhf band.

The receiver on the bus picks up the signal from the roadside transmitter. The receiver demodulates and converts it to a series of analog signals, or messages. These are then reconverted into pulses and fed into a circuit that determines whether the bus's location has changed. If so, the new signal is placed into the bus's location information register, which then releases the previous signpost number; the new number then is stored until the bus passes another sign-

post, and the cycle is repeated.

The buses are interrogated from a control center sequentially at the rate of 12 per second. The computer, via a vehicle address generator, sends out an interrogation signal to the bus. The transmission, coding, decoding, and reception at the bus are carried out in a manner similar to that used in the location process.

The identification number of each bus again is stored and then fed into a comparator, which checks the number of the bus to be interrogated against its route number, which the driver has set into the onboard equipment at the beginning of his run. If the numbers compare, a data transmission signal is sent back to central headquarters.

This done, the location and status information (the last signpost passed and elapsed time) then is coded into a series of pulses, processed, and transmitted by the bus's data transmitter. Because its range often is less than the distance to headquarters, three satellite receivers, or relay stations, are located throughout the city.

The rest is relatively simple. The computer reads the reply from the bus and checks it against stored information on the bus's schedule. Any deviations from the schedule are calculated. Schedules, stored in the computer, are flexible depending on traffic conditions, passenger load, and weather conditions.

If the dispatcher wants to talk to the driver, he simply dials the bus via a radio telephone. A selective call generator codes the identification number of the bus and places the call message between the interrogation messages being transmitted by the signposts. The signal is received by all buses, like a party line, but the comparator lets the message through only in the bus called by the dispatcher. Then the driver can speak to the dispatcher through a headset.

Errors found during tests of the Hazeltine system indicate that a fourth fixed station may be necessary in order to further refine the signal-location process. Most of the error comes from the multipath phenomenon. The signal processing in the Hazeltine system takes multipath error into consideration by feeding the first multipath signal received at each fixed station into the computer.

In its tests, Hazeltine is using an APX-6 IFF transponder in the van, but this old military-type gear will be replaced by a solid state unit being designed that will be smaller than an attache case. The first operating system is expected to be ready later this year.

Raytheon's entry into VLS also uses trilateration. But unlike the Hazeltine system which uses pulse timing at X-band, Raytheon employs a phase-ranging system operating at uhf. Raytheon feels that its system is more effective because uhf should suffer less from propagation problems. And in addition, it uses allocated ground mobile radio frequencies which make it possible to retrofit items to the existing system.

Like the Hazeltine VLS, the Raytheon system will not only locate vehicles, but it also will allow predetermined coded messages to pass to and from the vehicles. Voice communications would be saved for emergencies. In addition the Raytheon system can be adapted for use with in-car Teletype systems, thus conserving bandwidth.

The problems associated with VLS in urban areas, such as band crowding and control, control of signal-to-noise ratio, and multipath effects, have been weighed by Raytheon over the last 30 months in more than 8,000 propagation studies. The results of these studies, which were concerned with the physics of the problems and their control, were plugged into the design of the Raytheon automatic vehicle monitor.

The system operates as follows: stations are scattered throughout an urban area and are regarded as either slaves or masters—a central control designates the master. To locate a vehicle, the master transmits a message containing the vehicle identity code, ranging tones, and other pertinent information to



Simpson's new 2725.

Compare it with the electronic counter you were going to buy:

SPECIFICATIONS	SIMPSON 2725	YOUR COMPARISON
Wide frequency range?	YES. 5 Hz to 20 MHz.	
Measures frequency ratios?	YES. 1 to 1.99999 x 10 ⁵ .	
Measures time periods?	YES. 300 μ seconds to 0.2 second.	
Measures time intervals?	YES. 300 μ seconds to 1.99999 x 10 ⁵ seconds.	
Totalizes?	YES. 0 to 1.99999 x 10 ⁵ counts.	
Crystal controlled time bases?	YES. 6 xtal-controlled bases, switch selected.	
Self-test circuitry?	YES. Front panel switch tests logic circuitry.	
Dependable solid state design?	YES. Integrated circuits.	
Number of full time digits	5. Plus automatic overrange indication.	
Accuracy	±0.01% ±1 digit	
Price	\$525. complete with probe and operator's manual.	\$

4-digit Model 2724 also available: \$450.

GET "OFF-THE-SHELF" DELIVERY OF THE NEW SIMPSON DIGITAL ELECTRONIC COUNTERS AT DISTRIBUTORS STOCKING SIMPSON INSTRUMENTATION PRODUCTS

Simpson

ELECTRIC COMPANY



5200 W. Kinzie Street, Chicago, Illinois 60644 • Phone (312) 379-1121
 Export Dept: 400 W. Madison Street, Chicago, Illinois 60606. Cable Simelco
 IN CANADA: Bach-Simpson Ltd., London, Ontario • IN INDIA: Ruttonsha-Simpson Private Ltd., International House, Bombay-Agra Road, Vikhroli, Bombay

JFD MICROMINIATURE MODUTRIM

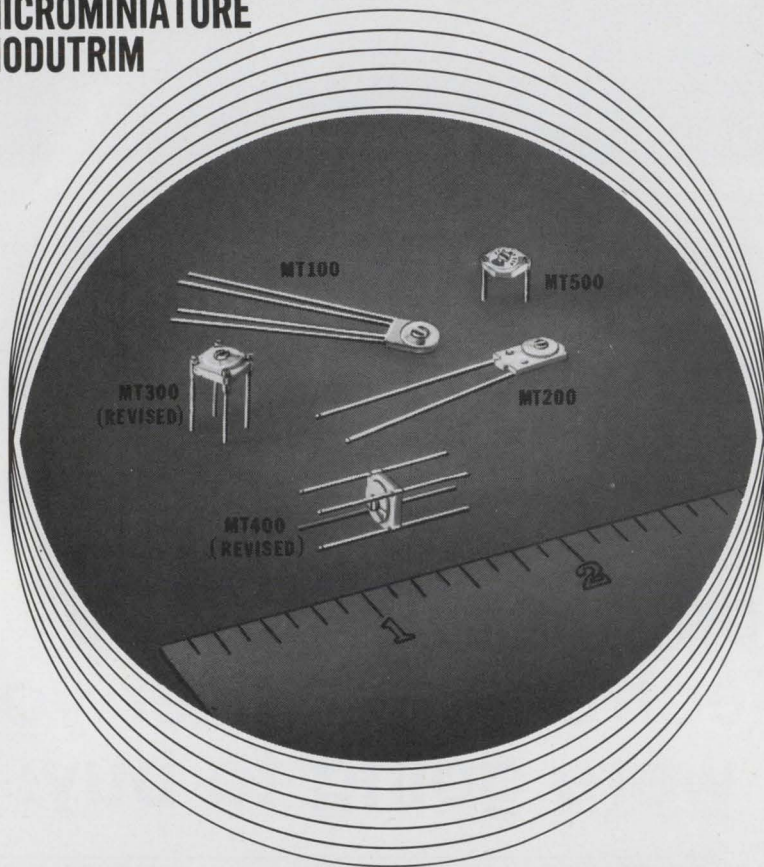

A UNIQUE CERAMIC VARIABLE CAPACITOR

Unique is the word that best defines the Modutrim—microminiature capacitor series. The MT series offers the design engineer superlative stability due to a special rotor designed by JFD. The rotor stability is due to a special proprietary ceramic material in a monolithic structure.

Especially designed for micromodule and hybrid applications, Modutrim is available in a wide range of Δ Cs with electrical characteristics that are outstanding for components of this exceptional small size.

Offered in 5 basic mounting configurations the Modutrim (MT100, 200, 300, 400 and 500) provides an optimum choice for your design applications.

In addition, JFD has modified its MT300 and MT400 series to provide added strength without affecting the mechanical or electrical parameters.

MT capacitors meet or exceed MIL-C-81.
JFD engineers are available to meet your design requirements.

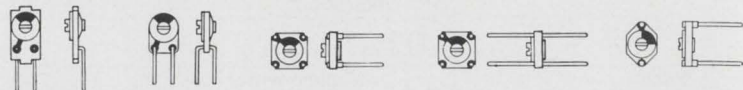

MT 100 MT 200 MT 300 MT 400 MT 500

Write for catalog.

Illustrations actual size.



"TODAY'S COMPONENTS BUILT FOR TOMORROW'S CHALLENGES"

JFD ELECTRONICS CORP. / COMPONENTS DIVISION

15th Avenue at 62nd Street / Brooklyn, New York 11219 / Phone 212-331-1000

SUBSIDIARY OF RIKER-MAXSON CORPORATION

See Us At The IEEE Show, Riker-Maxson Components Group Booth #'s 4E03 and 4E05
also the Paris Components Show April 3rd—8th Allée L Stand #53.

the car on the car's assigned frequency—the standard uhf police communication channel is 20 kilohertz wide. At the same time, this signal is sent to the other stations in the area of the particular master. But only the vehicle identified will respond with a signal, which is transmitted at a frequency 5 mhz higher than that received.

Both signals are broadcast omnidirectionally and all slaves measure the phase difference between the demodulated master and vehicle signals. Since the transponded range tone runs for several cycles, multipath and other bad effects can be averaged out through zero crossing counters. Multipath also can be cut by selecting only stations to process phase data with the best vehicle-master-slave links.

The master's signal consists of a synchronization bit, a digital code for vehicle identification, a digitally encoded message, if any, and a ranging tone. The entire signal is 30 milliseconds long, with 20 msec allocated for the message.

Returns from the master/slave stations and the transmissions to them are carried by 1,200-bit-per-second phone lines into a bank of commercial modems. A small computer, like the Raytheon 704, handles the buffering, multiplexing, and modem control tasks. The transmissions just as easily could be fed directly to a dispatcher control station consisting of a cathode-ray tube display console and teletypewriter, or a large map display with its own controls.

The Raytheon system can handle as many as 16,000 vehicles, but it is intended for fleets of up to 3,000 cars now. By reducing voice communications through prerecorded, encoded messages, Raytheon feels voice channel demand may be cut by as much as 80%.

Raytheon's design goal seeks a system operating with a fixed number of stations (one of which is a master) to determine a vehicle's location to within 600 feet. The fix is a circle with a diameter of 600 feet and a 95% probability that the car is in the circle. Shifting of the master function changes the multipath conditions each time the new master comes on the air; it should shorten the circle diameter to 300 feet without altering probability.

Other firms, both large and small,

A two-day seminar for the professional

Semiconductor Packaging in the 70's

April 16-17, 1970 . . . at Park Sheraton Hotel, New York City

Presented by Office of Special Programs Polytechnic Institute of Brooklyn.

Objectives: Engineers, designers and managers from a broad range of industries are called on to choose between various types and configurations of semiconductor devices. The choice of a single component in a complex system can spell the difference between success and failure.

One of the most pressing problems in semiconductor design, manufacture and use is the choice of packaging to be utilized. Many types of packages are currently available, and this conference is designed to separate and clarify the reasons why hermetically sealed packages can be useful for some environments, but are not necessary for others. This very complex issue will be separated into its important facets for clarity. The subjects to be specifically discussed include:

1. Current methods of packaging and chip joining;
2. Hermeticity;
3. Cost;
4. Corrosion;
5. Reliability; and,
6. Design decisions and consequences

This conference will present a comprehensive up-to-date series of talks specifically aimed at designers, materials engineers and management who are responsible for the various functions of supplying and using micro-electronic circuits. About 3½ hours per day will be devoted to discussion periods which will enable participants to exchange ideas with the authorities participating on the panels. The talks before each panel session will provide sufficient background for significant communication at the panel sessions.

Registration and Fees:

Registration will be limited to 350 and must be made in advance by mail. The registration fee will be \$100.00 for each participant. The cost of the luncheons and the cocktail hour during the conference is included in the registration fee.* Fill out and mail the registration form below before April 7, 1970. Checks should be made payable to Polytechnic Institute of Brooklyn.

Thursday: April 16, 1970

Program:

9:00 A.M. **Welcome and Introductions**
George J. Fischer, Polytechnic Institute of Brooklyn, Program Director

Session 1: Chip Interconnections

9:05 A.M. **Introductory Remarks**
Raymond D. Speer, Microelectronics Editor, Hayden Publishing Co., Moderator
9:30 A.M. **A Critique of Chip Interconnections**

Lewis F. Miller, Advisory Chemist, International Business Machines Corp.

11:00 A.M. Panel Discussion

David Angel, Engineer, National Semiconductor Corporation.

Frank Howland, Head, Applied Mechanics Dept., Bell Telephone Laboratories.
E. David Metz, Director, Integrated Circuit Applications Research Laboratory, Motorola, Inc.

Stanley Stuhlberg, Manager, Circuits Department, Raytheon-Bedford Laboratories.

12:30 P.M. **Luncheon**

Session 2: Hermeticity — Why and Where?

1:30 P.M. **Introductory Remarks**

Kenneth G. Niebling, Application Engineer — Electronics, International Nickel Co., Inc., Moderator

1:40 P.M. **The "Why" of It**

Stephen S. Baird, Plastic Reliability & Technology Consultant, Texas Instruments, Inc.

2:30 P.M. **The "Where" of It**

Arnold Lesk, Director, Central Research Laboratories, Motorola Semiconductor Products Division.

3:30 P.M. **Panel Discussion**

Edwin A. Cori, Senior Engineer, International Business Machines Corporation.

Vincent Lukach, Manager, Quality and Reliability Engineering, Radio Corporation of America.

5:00 P.M. **Cocktail Hour**

Friday, April 17, 1970

Session 3: Hermeticity — How? At What Cost?

9:00 A.M. **Introductory Remarks**

C. Robert Isleib, Application Engineer—In Charge Electronics, International Nickel Co., Inc., Moderator

9:10 A.M. **Hermetic Packaging Ceramic/Metal**

Joseph Marcello, Vice President-Marketing, Metalized Ceramics Corporation.

Glass/Metal

Ross Schraeder, Networks Manager, Texas Instruments Inc.

10:15 A.M. **Non-Hermetic Packaging**
Pawan Mehra, Product Manager, Encapsulation Equipment, Hull Corporation.

11:00 A.M. **Panel Discussion**

Gust J. Kookootsedes, Group Supervisor Dow Corning Corporation.

David Lansittle, Chief Engineer, Electrical Industries.

12:00 **Noon Luncheon**

Session 4: Reliability

1:00 P.M. **Introductory Remarks**

Alfred Tamburrino, Group Leader, Device Analysis Group, Rome Air Development Center, Griffis Air Force Base.

1:10 P.M. **Acceptance Testing & Quality Assurance**

John Lombardi, Supervisor, Electronics Evaluation Laboratory, Grumman Aircraft Corporation.

1:40 P.M. **Corrosion Caused by Service Environments**

Roger A. Covert, In Charge Corrosion Engineering, Product Research & Development, International Nickel Co., Inc.

2:10 P.M. **Panel Discussion**

Edward B. Hakim, Physicist, Electronics Component Laboratory, Fort Monmouth.
D. Stewart Peck, Department Head, Device Reliability, Bell Telephone Laboratories.

3:15 P.M. **Decisions and Consequences**

Bryant C. Rogers, General Manager, Fairchild Semiconductor Division.

4:00 P.M. **Adjournment**

Steering Committee

Director: GEORGE J. FISCHER
Professor of Metallurgical Engineering
Polytechnic Institute of Brooklyn
Co-Director: ROBERT J. MACIAG
Associate Professor of Metallurgical Engineering
Polytechnic Institute of Brooklyn

C. ROBERT ISLEIB
International Nickel Co., Inc.

JOSEPH W. MARCELLO
Metalized Ceramics Corporation

LEWIS F. MILLER
International Business Machines Corporation

KENNETH G. NIEBLING
International Nickel Co., Inc.

RAYMOND D. SPEER
Hayden Publishing Co.



POLYTECHNIC INSTITUTE OF BROOKLYN
333 Jay Street, Brooklyn, N.Y. 11201

Registration must be mailed no later than April 7, 1970

Advanced Registration Form

Mail to: Prof. George J. Fischer, Polytechnic Institute of Brooklyn
333 Jay Street, Brooklyn, N.Y. 11201 Telephone: (212) 643-2196

Enclosed is a check* for \$_____ to register the persons listed below for the conference on **Semiconductor Packaging in the 70's**, to be held April 16-17, 1970.

Please send me information on hotel accommodations.

*Registration Fee is \$100.00 per person. Make checks payable to:
Polytechnic Institute of Brooklyn.

Name _____
Other Attendee's Name _____
Company Name _____
Company Address _____ City _____
State _____ Zip Code _____



no lower
price.
no higher
performance.
anywhere.

Texscan's LA Series Rotary Attenuators.

KEY SPECIFICATIONS

ATTENUATION: Model LA-50, 0 to 10db in 1db steps; Model LA-51, 0 to 70db in 10db steps; Model LA-53, 0 to 1.0db in 0.1db steps; Model LA-54, 0 to 60db in 1db steps

FREQUENCY RANGE: DC-500 MHz

ACCURACY: LA-50, ± 0.3 db; LA-51, ± 0.5 db; LA-53, ± 0.05 db; LA-54, ± 0.5 db

DELIVERY: From Stock for Quantities of 10 or less

PRICES: Models LA-50, 51 and 53 — \$60.00, \$67.50 and \$65.00
Model LA-54 — \$120.00

All four models offer a variety of attenuation steps, connector options. Choice of 50 or 75 ohm impedance. Circle the reader service number below for descriptive literature containing complete technical details.



Texscan CORPORATION

2446 NORTH SHADELAND AVENUE
INDIANAPOLIS, INDIANA 46219
Phone: 317-357-8781 TWX: 810-341-3184

also have entered the vehicle location sweepstakes. Among them is Computer Systems Engineering of North Billerica, Mass., with system that uses tachometer input data. In Computer Systems' approach, an onboard navigation package reports to a central computer via modified radio equipment.

In Washington, D.C., Capital Scientific Corp. has devised a system that uses a low-power radio transmitter—similar to an electronic garage-door opener—with a range of a few hundred feet, that sends analog coded messages to modified police call boxes, where they are relayed over telephone lines to a central location for processing. The call box supplies the vehicle's location while the vehicle's analog signal identifies the vehicle.

On the West Coast, the Cubic Corp. of San Diego has performed limited tests on what it calls an inverted loran locator system. It uses a small transmitter in the 100-to-500-Mhz range which sends signals from the vehicle to three or more fixed slave stations. The signals are relayed from the slaves to a master computer site, where the vehicle's position is determined by using hyperbolic lines of position.

Though it's admittedly not in the VLS development business, Sylvania's Sociosystems Laboratory, a new group set up to develop systems relating to urban problems, is under contract to the San Francisco Police Department to develop a complete command and control system with vehicle location capabilities to be included later. Sylvania's effort covers two fronts. One, police car status reporting, is accomplished through the Digicom 100 system, whose primary function is to provide a digital communication link between the car and the dispatcher, eliminating channel crowding through prerecorded messages. The other system, the computer-run DC 1100, consists of a color crt displaying area maps and overlay information such as location of a complaint and a police car's proximity to it. Overlay matter is entered via a keyboard.

Along the same line as Hazeltine's VLS, Urban Scientific of Greenvale, N.Y., uses what is basically an IFF transponder-interrogator to trigger other transponders, both vehicular and stationary. The

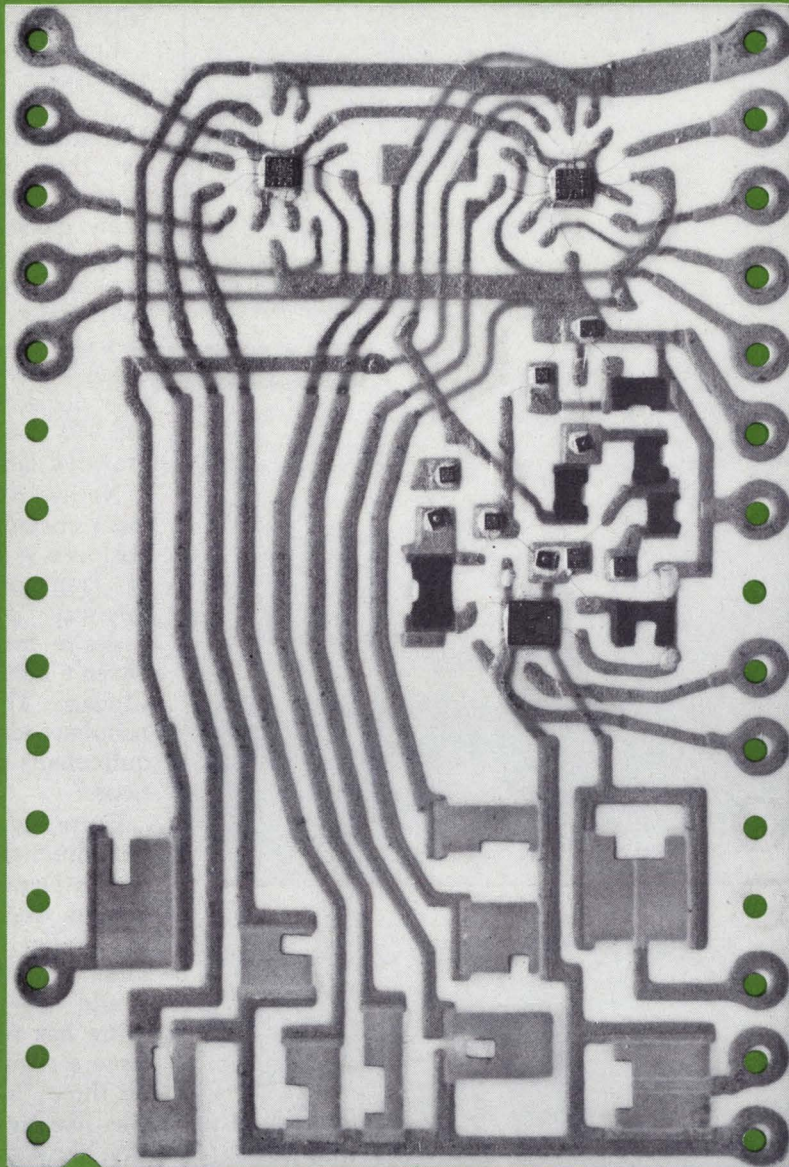

4X Actual Size.

A complete 8-bit Digital-to-Analog Converter for \$75!

The new Helipot Model 845 is a thick-film, miniaturized hybrid digital-to-analog converter (DAC) that converts an 8-bit binary word into an analog output. The input gates, switches, resistor network, reference voltage, and output amplifier are all in the hybrid module.

Because of its operating temperature range (-20°C to $+85^{\circ}\text{C}$), Model 845 can be used for any industrial digital-to-analog conversion, process control being a typical application. Price is \$75/unit in 1-9

quantities (less in greater numbers). The package size is 1.0 inch x 1.5 inches x 0.170 inch. The unit accepts an 8-bit, parallel, binary word that is TTL- and DTL-compatible, and an enable gate is provided. Four different output-voltage ranges are available as standard models: two unipolar (0 to +5 v, 0 to +10 v) and two bipolar (-5 to +5 v, -10 to +10 v). Power-supply requirements are +15 v at 60 ma and -15 v at 10 ma. The output accuracy is $\pm 1/2$ least-significant bit at $25^{\circ}\text{C} \pm 1$ mv

per percent of supply-voltage variation. The output-current range is 0 to ± 2.5 ma, and the output slew rate is 0.3 v/ μsec .

And, it's available from stock.

Beckman[®]

INSTRUMENTS, INC.

HELIPOT DIVISION

2500 HARBOR BOULEVARD

FULLERTON, CALIFORNIA 92634

INTERNATIONAL SUBSIDIARIES: AMSTERDAM; CAPE TOWN; GENEVA; GLENROTHES, SCOTLAND; LONDON; MEXICO CITY; MUNICH; PARIS; STOCKHOLM; TOKYO; VIENNA

Circle 155 on reader service card

SAVE space... weight... money...

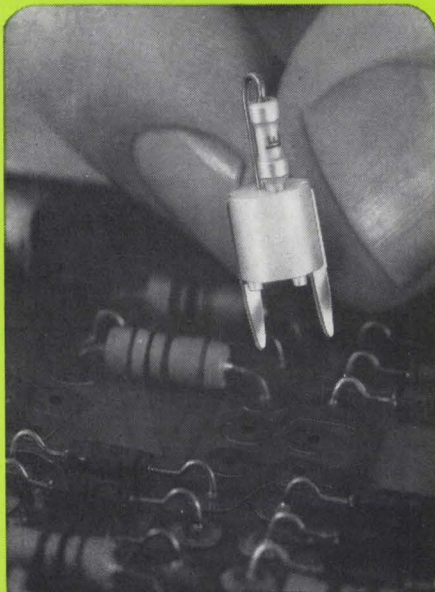

NEW PLUG-IN HOLDER . . . for Littelfuse subminiature fast acting picofuse, is designed for P. C. board installation. Accepts regular or high reliability picofuses with ratings from 1/16 to 10 amps. Picofuse . . . the world's smallest fuse . . . weighs only 1/5 gram. Ideal for computers, sophisticated airborne instruments and other subminiature circuits.

Write, wire or call today for full technical data.

LITTELFUSE

SUBSIDIARY OF TRACOR

800 E. Northwest Highway, Des Plaines, Ill. 60016
Phone 312-824-1188 • TWX 910-233-3598

Circle 245 on reader service card

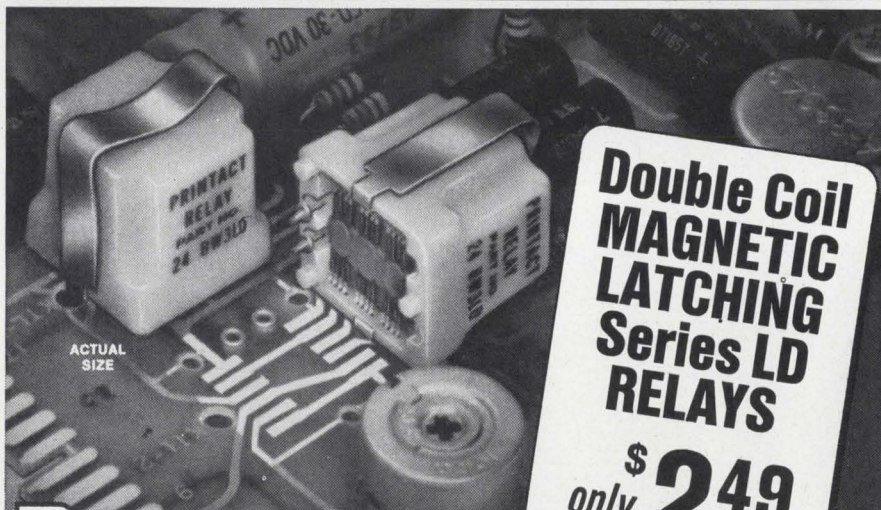

**Double Coil
MAGNETIC
LATCHING
Series LD
RELAYS**

\$249
EACH
(IN LOTS OF 5,000)

Printact®

Plugs into your PC board . . . mates with plated conductors

Where memory without power is a requirement in the design of control circuitry, the use of the "LD" relay results in a compact-low cost module. Reliability is assured by the unique design which includes, as standard, many features not generally available in commercial relays.

Encapsulated coil, bifurcated gold or palladium contacts, low thermal EMF, plug-in without sockets or soldering, low bounce and chatter, series-break switching eliminates pig-

tails, permanent magnet avoids return spring and mechanical linkage—all of which assures continuous performance for many millions of cycles.

Available with 6, 12 or 24 VDC 1 watt coil (AC operation with series diode) in 2, 3 and 4 pole configuration. Series break swingers permit each pair of fixed contacts to be etched with common (Form C) or isolated (Form A plus Form B) switching between make and break circuits.

For data write or call 212-EX 2-4800.

Printact Relay Division, Executone, Inc., Box 1430, Long Island City, N.Y. 11101

vehicles are identified through codes; location is effected through trilateration.

From the governmental agency standpoint, VLS still has a long way to go. Despite the claims made by Hazeltine, Raytheon and the others for their systems, the Federal Communications Commission feels many questions concerning operational frequencies and requirements remain unanswered. At present, the commission would prefer frequencies above 2,400 Mhz (S-band) and those below uhf for VLS. However, most developers prefer to operate in the 450-to-470-Mhz band—the very crowded land-mobile spectrum.

Notwithstanding the FCC, the main obstacle confronting VLS developers is money. A Department of Transportation official puts it this way: "Many cities have voiced a desire for VLS, but so far they haven't done their homework like Chicago. They just come up with nebulous ideas, but no specific requirements and no proposed solutions."

Currently, the Urban Mass Transit Administration (UMTA), an arm of the Department of Transportation, is working with Mitre Corp. to develop a cost-matrix to determine how much a given system would cost for a given-size city. Mitre has recommended that DOT issue a request for proposal to bid on three "abstract" cities: a large one, like New York, a medium-size city, like Atlanta, and a smaller one, such as Syracuse. The cities would deliberately not be named by UMTA in order to prevent contractors from rushing in with proposals formulated under specific city conditions such as tall buildings or severe electronic interference. Such action, according to Mitre's associate technical director William Mason, would defeat the concept of a cost-matrix goal.

In addition, Mitre is recommending that UMTA award a "token" sum of money to at least three and as many as six contractors to build a sample VLS station. According to Mason, these would be "working breadboards" to test the transmission problems in each type of city—small, medium, and large. The awards, if approved by UMTA, probably would be made within the next 12 months, according to an UMTA spokesman. ●



BETTER QUALITY AND RELIABILITY THROUGH CONTROL

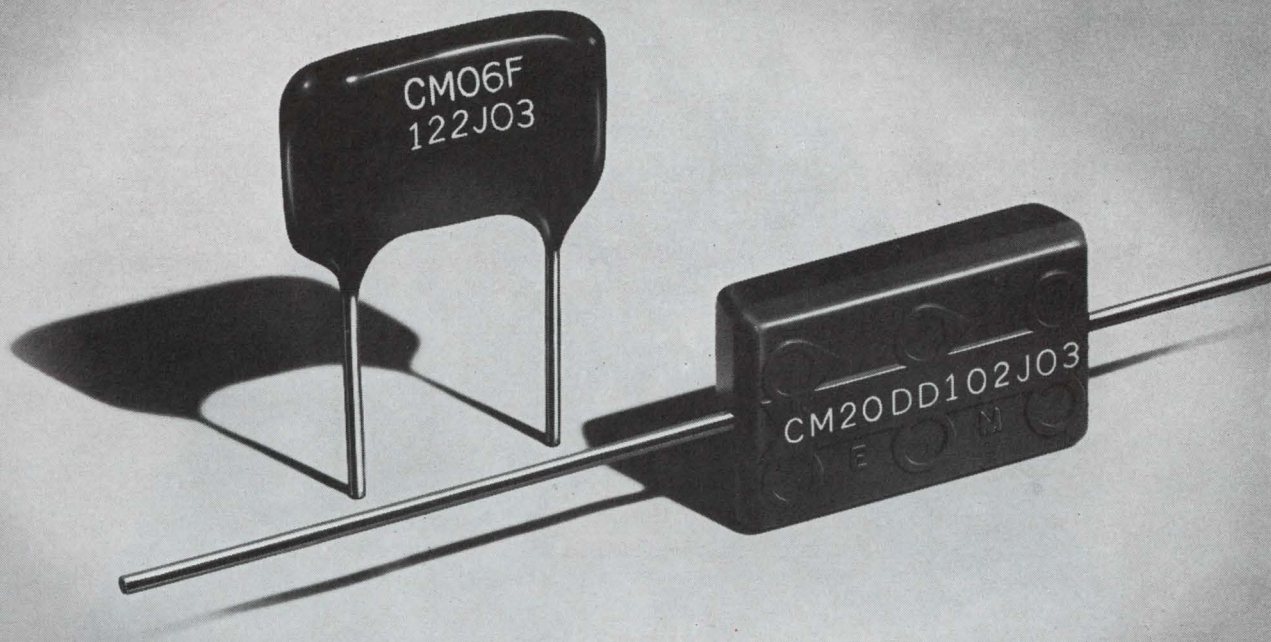

Shown 2½ x Actual Size

Capacitor Problems That Require A Lot Of Self-Control...Chemically Speaking

Problem 1: How to make sure the silver paste composition used for electrodes provides the best results for each electrical parameter in a given capacitor design?

Problem 2: How to improve the recognized moisture reliability of our dipped mica capacitors without adversely affecting life reliability?

Problem 3: How to upgrade the reliability of molded mica capacitors to equal that of dipped mica capacitors so designers can take advantage of body uniformity and axial lead design?

Solution: Chemical self-control! To do this we operate our own chemical manufacturing plant where we formulate silver pastes, phenolic dipping compounds, and epoxy molding compounds — all under strict controls.

Result: Dipped mica capacitors and molded mica capacitors of equally high reliability that operate up to 150°C. Send for technical literature and always insist on El-Menco brand capacitors . . . your assurance of better quality and reliability through control.

THE ELECTRO MOTIVE MFG. CO., INC.

WILLIMANTIC, CONNECTICUT 06226

Dipped Mica • Molded Mica • Silvered Mica Films • Mica Trimmers & Padders
Mylar-Paper Dipped • Paper Dipped • Mylar Dipped • Tubular Paper

West Coast Manufacturers contact: COLLINS & HYDE CO., 900 N. San Antonio Rd., Los Altos, California 94022
5380 Whittier Blvd., Los Angeles, California 90022

ALSO SOLD NATIONALLY THROUGH ELECTRONIC PARTS DISTRIBUTORS

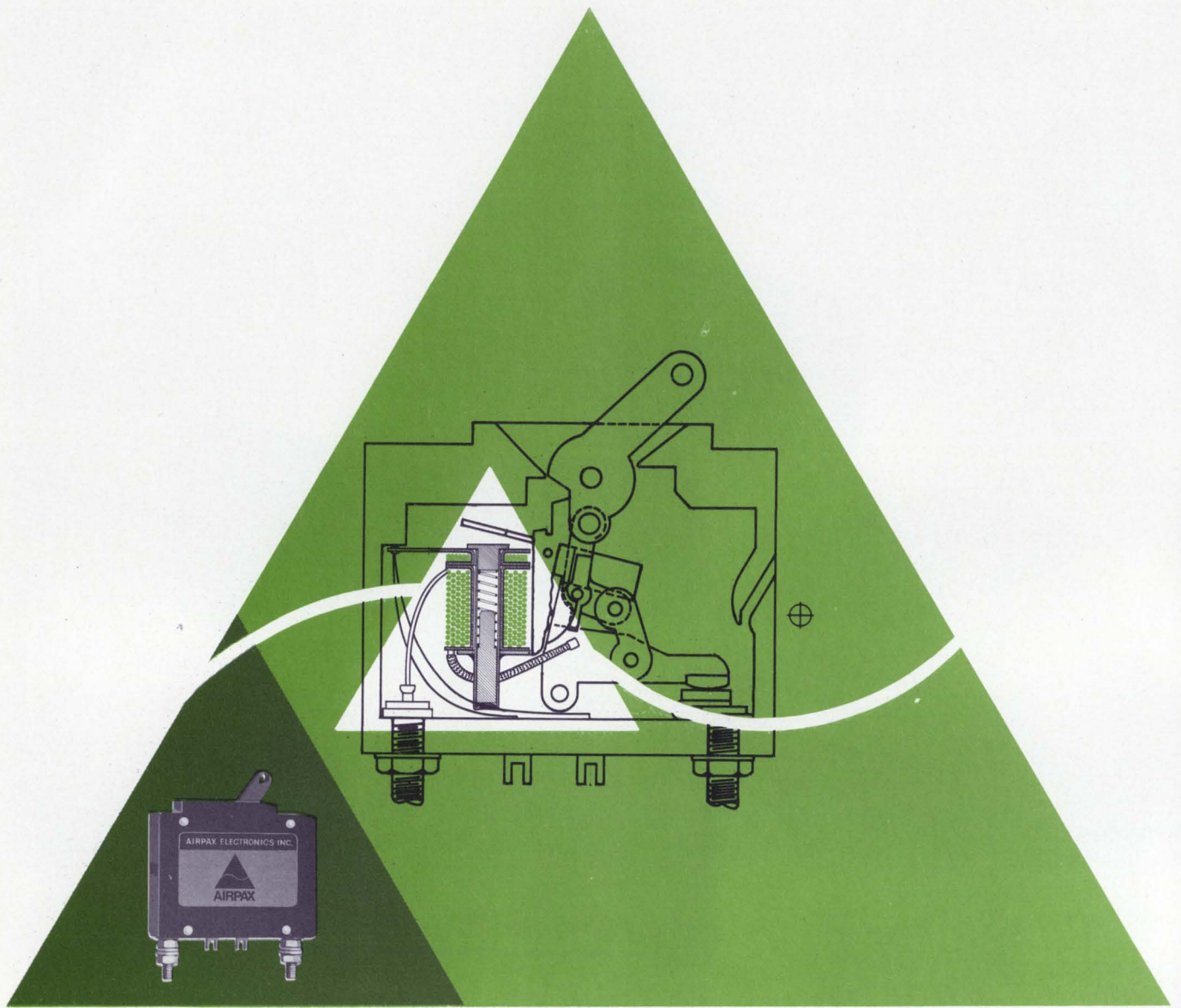

Smaller, lighter, less expensive circuit protector reacts to both voltage and current.

Airpax engineers have developed a single-pole magnetic circuit protector that reacts like a two-pole breaker but it is smaller, lighter, and less expensive. The new dual coil protector is both voltage and current sensitive and can also be connected as a wattage-sensitive device. **Another Airpax component of confidence!** □ In addition to conventional circuit protection, the new device can be used in conjunction with a temperature transducer to protect heat-sen-

sitive equipment such as power supplies. By connecting a sensing device to the voltage coil of the circuit protector, it can be used in interlock circuits or can react to pressure, flow, weight or fluid level.

□ The current coil ratings are from 0.050 to 50 amperes at 50 VDC or 250 VAC maximum, 60 or 400 Hz. For more detailed information, call or write **Airpax Electronics, Cambridge Division**, Cambridge, Maryland 21613. Phone (301) 228-4600. Telex: 8-7715. TWX: (710) 865-9655.

AIRPAX ... components of confidence.

Computer clocks at 10 megahertz

IC memory, flexible instruction set, and more than 30 accumulators make compact unit a high-performance machine for real-time data reduction jobs

By James Brinton

Electronics staff

"It's about as much computer per dollar as the state of the art allows." That's the claim made by Computer Signal Processors Inc. for its CSP-30, and the marketing pitch is backed up with these specifications:

Clock rate, 10 megahertz; machine cycle time, 100 nanoseconds; instruction rate, about 3,000,000 per second; hardware multiply time, 1.0 microsecond; IC memory, 512 to 2,048 16-bit words and a cycle time of 100 nsec; accumulators, 32; index registers, 14; core memory, 4,096 to 28,672 16-bit words; core access time, 350 nsec; cycle time, 900 nsec; and price, about \$85,000 to \$100,000.

This is a difficult machine to place in standard categories. Judged by its 16-bit word length it might be termed a high-price minicomputer; its instruction rate (50% faster than a Control Data 6600's) could make it a low-cost 'maxi' computer—as would its exceptional number of accumulators and registers. Its swift hardware-multiply and other arithmetic capabilities rank it with or above the best special-purpose digital signal processors—but its architecture makes it as much a general-purpose computer as the programmer desires.

The compact CSP-30 was designed to be fast because of its originally intended market in signal-processing applications with their repetitive arithmetic operations. The result is a machine partially filling a single relay rack—including cassette tape I-O. This miniaturization was needed partly to get the computer into applica-

tions that required small bulk, such as on-site geological data processing. But the machine had to be small anyway, to achieve the desired speed.

The logic and memory swing out and down on a single front panel to expose card after card of Fairchild IC memory—128 16-bit words per board—and between the up to eight memory cards at either end of the panel are the central processor and control unit cards. These are centered between the IC memory cards to minimize the path length between memory and cpu.

IC memory and short path lengths help raise speed, but other methods are used, too. All the printed-circuit boards are multilayered—some of them have six layers with central ground planes, reminiscent of microwave stripline construction. Chip capacitors are used on the memory cards—packaged units would have added parasitic inductance and capacitance that would have slowed the machine. There are no test points on the cards; all are on the back panel. To have routed them on the cards would have added 14 picofarads of needless capacitance for every 5.5 inches of card height, and exacted a speed penalty.

Company president Edmund U. Cohler enjoys characterizing the machine in terms of given tasks. For example, in a digital signal-processing application, it takes the CSP-30 6 milliseconds to perform the basic loops in a 256-bit fast Fourier transform. The nearest competition in speed is said to be the IBM 360/65 at 22 milliseconds; and the machines nearest in price

to the CSP-30, the EMR 6135 and EMR 6130, take 44.4 and 52.4 msec, respectively.

Capitalizing on the machine's rapid signal-processing abilities, CPSI offers 5 signal-processing software families: fast Fourier; direct convolution, cross correlation, and autocorrelation; recursive digital



Computer power. CSP-30 can be adapted to variety of EDP jobs.

The first plug-in curve tracer costs 1/3 less!

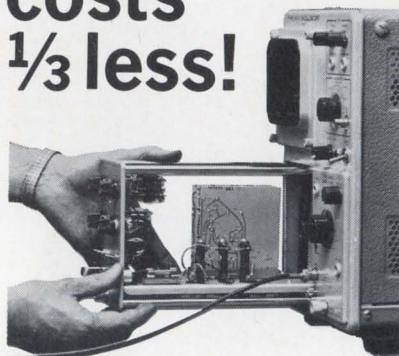

With U-Tech's plug-in and console units, any X-Y oscilloscope becomes a curve tracer displaying the dynamic characteristics of both NPN and PNP transistors, N Channel and P Channel junctions, FET's, MOS-FET's, bipolars, unijunctions, diodes, tunnel diodes and SCR's. You have curve tracer capabilities, without buying a complete curve tracer unit. In so doing you pay up to:

1/3 less!

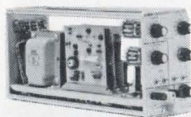

U-Tech plug-in **MODEL 681**: \$655.00*. For use with Tektronix† 560 Series Oscilloscopes.

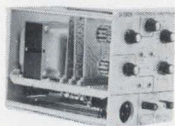

U-Tech plug-in **MODEL 682**: \$675.00*. For use with Tektronix† 530, 540, 550, 580 Series Oscilloscopes.

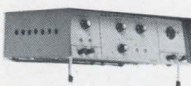

U-Tech console **MODEL 683**: \$685.00*. For use with any X-Y Oscilloscope.

Ask your distributor about these U-Tech curve tracer units or order direct from:

U-TECH

A DIVISION OF INDUSTRIAL PHYSICS AND ELECTRONICS COMPANY
4190 SOUTH STATE STREET,
SALT LAKE CITY, UTAH 84107
(801) 262-2663

*Registered trademark Tektronix Inc.

†Prices apply to purchase and shipments within U.S.A. fob Salt Lake City, Utah

Modular makeup. Multilayered cards for memory and processing are designed for speed, flexibility in programing and ease of testing.

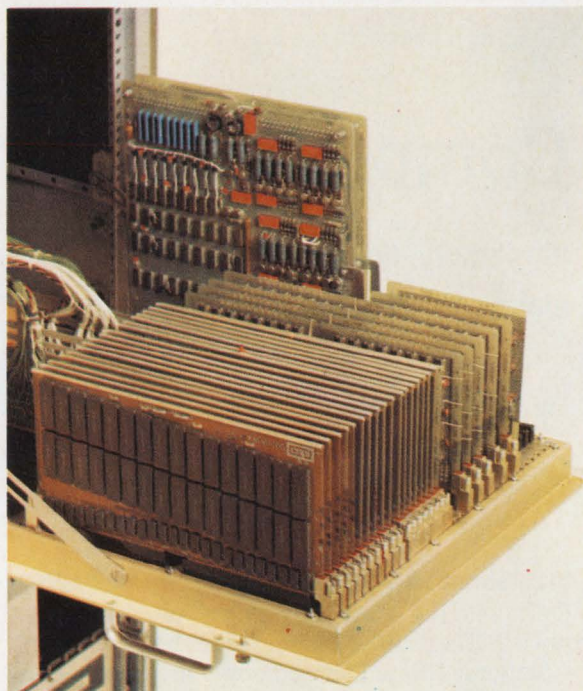

filtering; ensemble average; and finally, amplitude histogram. These are comprehensive families; the fast Fourier library alone includes ten algorithms, from Cooley-Tukey and Zoom-FFT to mixed radix.

But the machine is claimed to be just as well suited for general purpose applications, especially those which are computer-power limited. The large number of registers and accumulators allows rapid completion of interrupt loops; background read-fetch operation removes much of the speed penalty associated with the core memory—without having to use the IC memory as a cache or buffer (there are enough accumulators).

Donald N. Graham, director of software and system analysis, feels that the success of the CSP-30 as a general-purpose computer will be limited largely by the creativity of the programmer. "There's a saying that any program can be shortened by one instruction, and that the process is recursive. Well, with this machine," he says, "we'll find out if it's true."

"It's not difficult to program," says Cohler, "rather, it's easy. The CSP-30 isn't so much 'idiot proof' as 'idiot indifferent'; it's impossible, for example, to program a wrong result through timing errors. And the assembler will even assemble your errors—it will tell you that they're errors, but it'll assem-

ble them for you."

Ready set. Of the 128 basic instructions for the CSP-30, most have operational variations. There are eight variations possible with each of the eight arithmetic instructions which allow the programmer to specify the sources of operands and the destinations of results—and with 34 accumulators and 14 index registers, this means a great deal of flexibility.

The non-arithmetic half of the instruction set is largely made of test and transfer instructions, and it's here that the crafty programmer can save machine time.

The CSP-30 can 'skip' after AND or NOR operations, or less-than, greater-than, or equal-to tests—whether the test is a success or a failure. Other such tests include compare with zero, with any bit in any accumulator, checking against the status of control flip-flops, the I-O control unit, or a peripheral device.

There are pushdown list instructions, and the length of the list is limited only by available memory. These instructions are used for interrupts, subroutine calls and returns. They allow multiple points of entry and recursive subroutines; eventually they will be used to enter read-only-memory stored subroutines.

IC versus core. The smart programmer will arrange his program

a little blue pill for budget blues

BOURNS MODEL 3365

1/2" wirewound adjustment potentiometer

Tense? Wrought with anxiety over lowering the cost on printed circuit board assemblies? Here's the prescription: Bourns Model 3365, a 1/2" high-quality single-turn wirewound.

Consider the ingredients: resistance range from 10 to 50,000 ohms, with a $\pm 5\%$ TR tolerance; power rating of 1 watt at 25°C; sealed to withstand fluxing and soldering operations; noise-free operation. Meets MIL-STD-202 for steady-state humidity and MIL-R-27208 for shock, vibration and load life.

It's easy to take: two-way adjustment, by thumb or screwdriver; \$1.21 in 1,000-piece quantity for low profile (.24" high) to adjustment model; \$1.58 for the side adjust.



Actual Size

Additional information on Model 3365 is as close as your phone. Call your local Bourns sales office; or your Bourns distributor... he has it on the shelf.



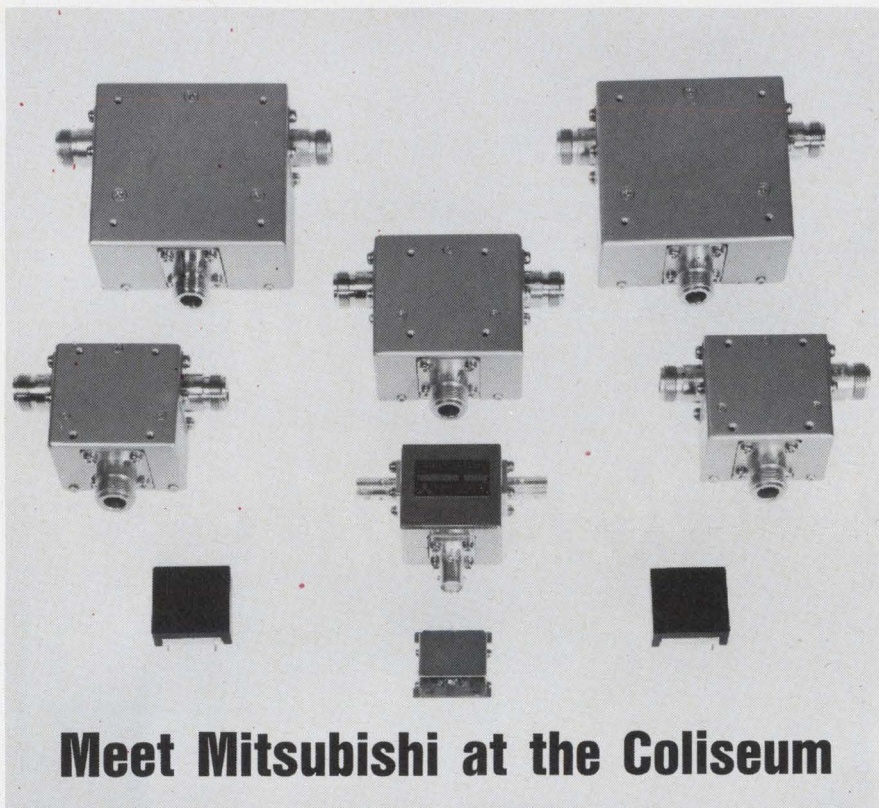

Meet Mitsubishi at the Coliseum

The '70 IEEE Show is the time. Booth 4G17, New York Coliseum is the place. And this year Mitsubishi is proud to show the newest results of our research and advanced techniques—Miniature Coaxial Circulators; VHF, UHF, SHF. We urge your special attention to our 700 MHz type. We expect this built-in model to have a big impact on the IC field, making much smaller communication equipment possible.

We are also showing miniaturized broad-band S-band circulators, and monolithic ICs—both digital and linear.

ADVANCED AND EVER ADVANCING

MITSUBISHI ELECTRIC
 Marunouchi, Tokyo, Japan

Circle 162 on reader service card

FIGHT THEM ALL...

**Heart Attack
 Stroke
 High Blood Pressure
 Rheumatic Fever**



GIVE ... SO MORE WILL LIVE HEART FUND

so that data from core awaits his manipulation either in IC memory or in one of the machine's many registers. Specialized instructions allow the programmer to transfer data from core into the accumulator file while instructions in the IC memory are being executed. Thus, even though the cycle time for the core memory is 900 nsec, Graham estimates that good programmers will encounter little if any delay in acting on a piece of core-stored data.

The CSP-30's instruction set also includes multi-operand instructions, and instructions which can use data on input lines as operands—replacing an operand from an accumulator and allowing any operation on input data that's possible on data already in the machine. So flexible is its software that with one instruction, the CSP-30 can take the contents of one register, add it to that of another, multiply it by a third, and store the result.

Pipeline. The CSP-30, designed for real-time signal processing, may make possible serial operations—say in industrial control—that so far haven't been economical even with time-shared computers.

Its direct memory-access rate says it all: 10 million words per second, made possible by sequentially dumping the contents of one memory into another. In addition, four I-O channels are available; three capable of 16 megabit data rates, and a fourth for use with devices having "medium-speed transfer rates," 1.6 megabits or less.

With a machine this fast, Cohler and Graham look forward to applications in real-time seismic data reduction in petroleum geology, high-speed multichannel process control, real-time vibration testing, fast optical character recognition, computer network control, modem operation and simulation, spectrometry, real-time analysis of electromagnetic pulse and explosion data, and many other areas.

Unit number one will be delivered late in April, and production should reach two units per month by the third quarter of 1970. Prices will range from \$85,000 to \$150,000, with the average unit running about \$100,000.

Computer Signal Processors Inc., 209 Middlesex Turnpike, Burlington, Mass. 01803. [338]

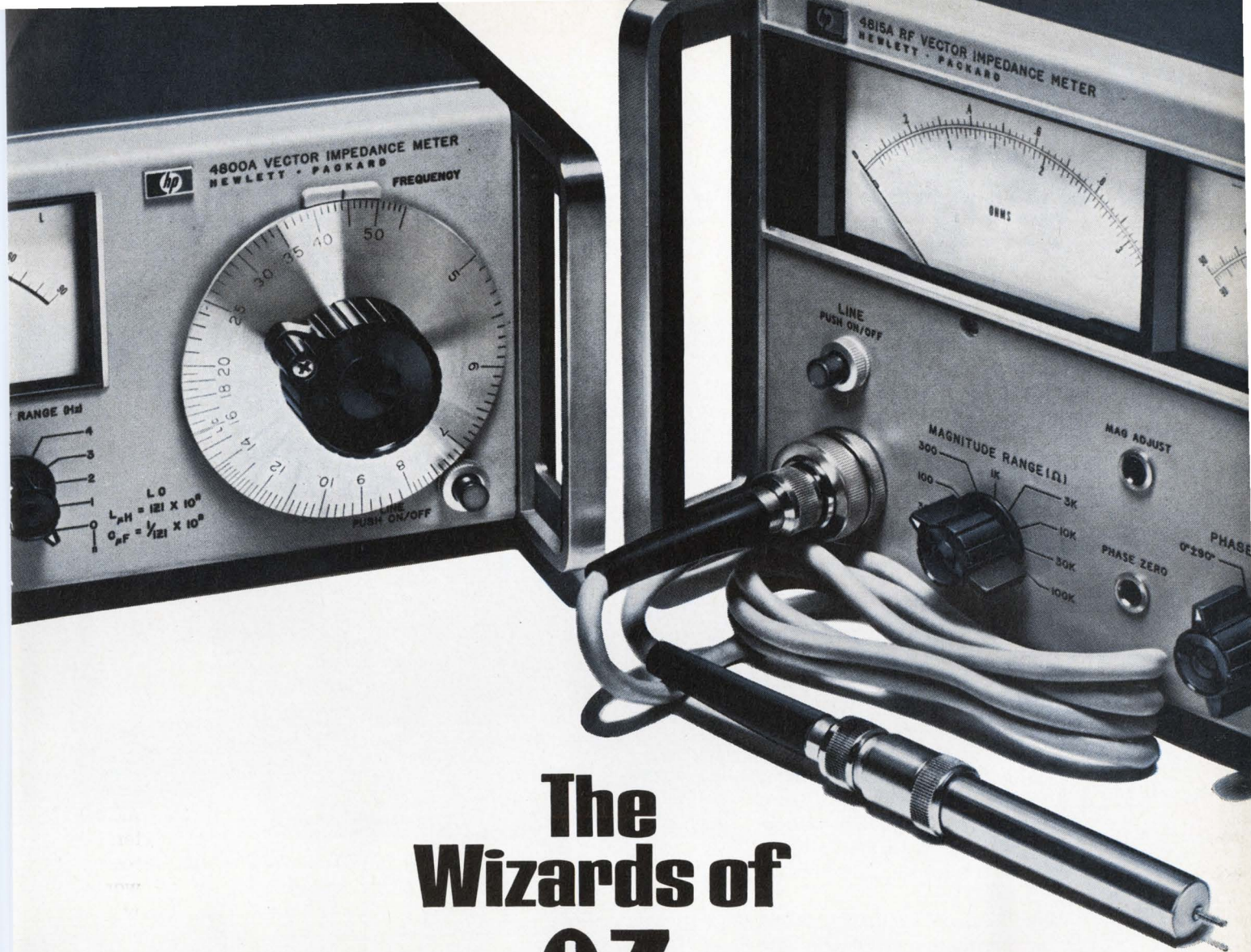

The Wizards of θZ

Like magic . . . vector impedance instruments read out complex impedance in an instant.

With the HP impedance meters, measurements involving impedance magnitude, Z , and phase angle, θ , no longer require tedious test procedures. These measurements are now as easy to make as voltage readings. No nulling . . . no balancing . . . no calculations to make. The wizardry of these HP instruments provides direct readout of Z (in ohms) and θ (in degrees) over a continuous frequency range.

HP 4800A Vector Impedance Meter covers the 5 Hz to 500 kHz range. You set the frequency, select

the impedance range and read: Z from 1 ohm to 10 Megohms, and θ from -90° to $+90^\circ$. \$1650.

HP 4815A RF Vector Impedance Meter covers 500 kHz to 108 MHz. Measures, via a probe, active or passive circuits directly in their normal operating environment. Z from 1 ohm to 100 K ohms; θ from 0° to 360° . \$2650.

Application Note 86 describes many applications of the 4800A and the 4815A Vector Impedance Meters including the measurement of Z , R , L , and C . For your copy and complete specifications, contact your local Hewlett-Packard field engineer or write: Hewlett-Packard, Green Pond Road, Rockaway, New Jersey 07866. In Europe: 1217 Meyrin-Geneva, Switzerland.

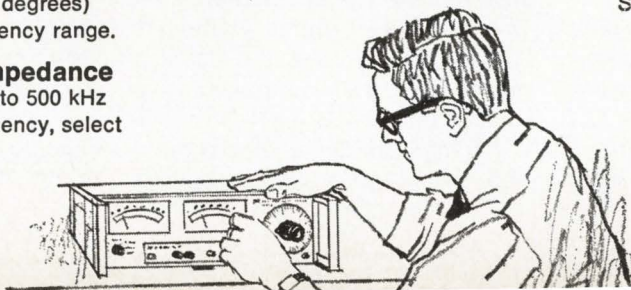

HEWLETT **hp** PACKARD
IMPEDANCE INSTRUMENTS

Sweeper hits 2.35 Ghz without plug-ins

There's a bit of the maverick in the VS-90, Texscan Corp.'s new sweep generator. While most sweepers that cover the megahertz-to-low-gigahertz range consist of a mainframe plus some plug-ins, the VS-90 is all in one box. But out of that box come frequencies from 5 megahertz to 2.35 gigahertz, split into ranges of 5 Mhz to 800 Mhz, 750 Mhz to 1.3 Ghz, and 1.25 Ghz to 2.35 Ghz.

"What we've done," says Texscan general manager Larry Dolan, "is push our type of unit up to 2,350 Mhz. We've got the marker system that works up there, and the attenuators; and instead of going to plug-in heads, we've put all the bands in one unit and saved quite a few bucks." A normal 1-to-2 Ghz plug-in costs \$1,800 without the mainframe, he notes, adding: "We're offering 5 to 2,350 Mhz for just \$2,500."

Why then, do so many makers opt for the plug-in approach? Says Dolan: "There have always been two different types of sweep generators. Below 1,000 Mhz or 1,200 Mhz were the types we made—the complete instrument with the built-in attenuators and a fancy marker system. Above 1,000 Mhz the trend was to go to plug-in types with bands of 1 to 2 Ghz, 2 to 4, 4 to 8, and so on, with no crystal marker-control setup. Now I think it evolved this way because to get above 1,000 Mhz, for years and years you had to change from transistors or tubes to backward-wave oscillators [bwo's are built with a special type of tube] and these covered octave bandwidths."

As Texscan is demonstrating with the VS-90, bwo's aren't needed anymore in the low-gigahertz region. "Transistors have been getting better and better," says Dolan.

Aside from going to high frequencies, the sweep-generating scheme Texscan engineers use in the VS-90 isn't unusual. A pair of varactor-swept oscillators generate



Trial sweep. The frequency generator, top, is sweep-testing a tunable bandpass filter, and output is shown on the oscilloscope.

the frequencies for the two high ranges, while the 5-to-800-Mhz signals evolve from mixing a 1.3-Ghz signal with the output of the 1.25-to-2.35-Ghz oscillator.

Along with range and price, the marker system is a key feature of the sweeper. Accurate to within 0.005%, the VS-90's crystal-controlled markers are something new in gigahertz sweepers. Says Dolan, "The best that microwave-sweeper markers can do is 1%."

The VS-90's output, whose minimum value is 750 millivolts into a

50-ohm load, is flat to within ± 0.5 decibel when the unit sweeps over a complete range. As the sweep gets narrower, the output gets flatter, becoming as good as ± 0.1 db for 10% sweeps.

The sweep-rate switch on the front panel has 5 settings: variable from 5 hertz to 60 hz; variable from 0.05 hz to 5 hz; line-frequency; manual sweep; and external.

The VS-90 will be introduced at the IEEE Show, Booth 2F03.

Texscan Corp., 2446 N. Shadeland Ave., Indianapolis, Ind. 46219 [383]

Low-priced dvm's entered

Best known for its medium- and premium-priced digital voltmeters, Dana Laboratories has decided to move into the low-priced dvm arena with models 3800 and 3860. The model 3860 is a simple three-digit dvm (with a fourth digit for

overrange) offering five direct-current measurement ranges (100 millivolts to 1,000 volts), and six ohm-measurement ranges (100 ohms full-scale to 10 megohms full-scale). The instrument sells for \$350.

But, \$75 more will get you the

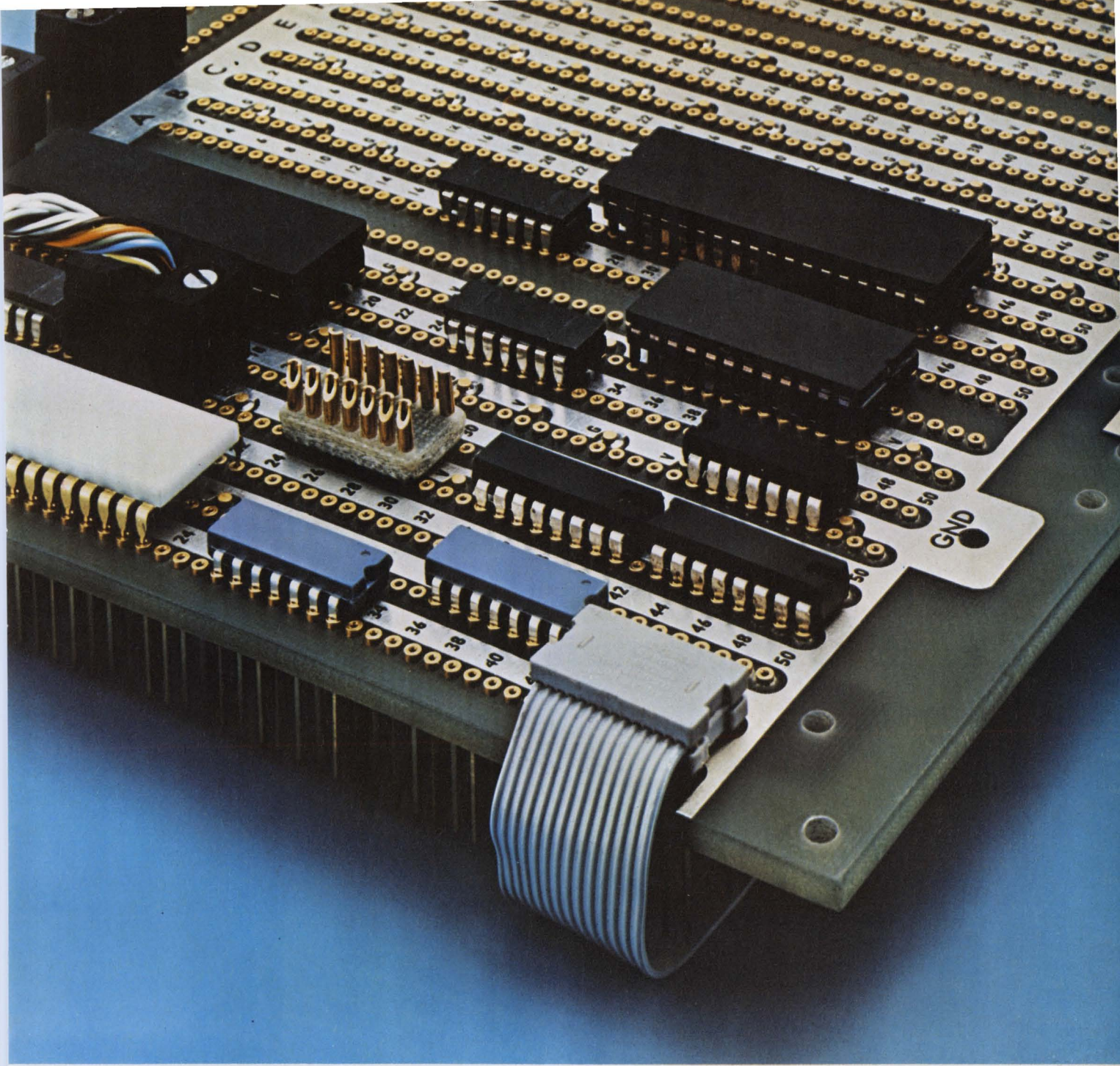

Plug in anything

Let Augat's new universal board provide complete flexibility in IC packaging and prototyping.

You can plug in any dual-in-line IC including popular 14, 16, 24 or 36 packages. The rows of contacts also accommodate our adaptor plugs for interposing discrete components and plugs for I-O connections and interfacing. Board also accepts Augat's new 14-pin, flat cable plug with unique patented design permitting fast assembly without stripping the wire. Plugs directly into IC socket pattern.

Universal board is available in modules of 9 rows with 50 contacts to a row up to 6 modules. Additional pins

tied in to power and ground planes are strategically located . . . easily accessible. No interference with IC patterns. Like all Augat panels, board is available automatically wrapped to your specifications.

Why be restricted in your packaging and prototyping? Let Augat open the door to greater flexibility.

Call us, (617) 222-2202, or write for our complete IC folder. Augat Inc.
30 Perry Ave. Attleboro, Mass. 02703.

AUGAT^{INC.}

"At IEEE Booths H12-14"

Circle 165 on reader service card



model 3800, a three-digit machine with a full multimeter capability. This includes the same five d-c and six ohm-measurement ranges offered in the model 3860. Tony Schiavo, product specialist at Dana, says most competitive instruments offer four d-c measurement ranges

and four or five ohm-measurement ranges.

The model 3800 also provides four a-c measurement ranges (1 volt to 1,000 volts), and the ability to measure direct current as a built-in feature rather than doing d-c measurements with shunts. The a-c measurement capability allows the user to go up to 100 hertz instead of the 10 to 20 hz limit usually found in low-priced dvm's, Schiavo says.

Accuracy of the model 3800 is specified as 1% for 90 days and stability is 0.1% for six months. The instrument uses a three-pole filter to achieve noise rejection of 60 decibels at or near 60 hz, and offers common-mode rejection of 100 db at 60 hz.

Dual-slope integration is used on

the model 3800. This is a less expensive technique than the successive approximation employed in Dana's medium- and premium-priced multimeters. The instrument is housed in a Cylolac casing which is more economical than metal. Also, putting all the electronics on one large board rather than using multiple plug-in boards saves money and permits the lower price tag.

One option is available with the model 3800—a binary-coded decimal output. It costs an additional \$70, bringing the price of the instrument with this feature (model 3800-01) to \$495. The new series will be displayed at IEEE Show Booth 2H39.

Dana Laboratories Inc., 2401 Campus Dr., Irvine, Calif. 92664 [381]

Sampling-scope rate is tunable

Sampling plug-ins tend to stay plugged in, engineers at Philips Electronic Instruments point out. Those who need sampling scopes need them all the time. For these engineers, Philips has built the PM3400, a sampling scope, complete in itself, that sells for \$2,725. It will make its debut at the IEEE Show, Booth 2E03.

The 3400's principal feature is that its sampling rate is continuously adjustable. With other sampling scopes, the user gets just three choices—10, 100 or 1,000 samples per centimeter. The variable rate, combined with smoothing and the use of long-persistence phosphors, provides unambiguous displays that Philips says are equal to those of real-time scopes.

Another sampling problem that the Philips engineers tackled is internal triggering. Because this is difficult to achieve in a sampling-type scope, most units operate with external triggering. Philips allows the 3400 to trigger internally by putting delay lines in both vertical channels. This ensures that the time-base generator starts before the input to the scope is applied to the sampling gate. And, says Philips, it removes ambiguity and

error from the display because leading edges are not ignored. The 3400 can internally trigger to more than 1.7 gigahertz.

The 3400's bandwidth is d-c to 1.7 Ghz, and its sensitivity is variable between 1 millivolt and 200 mv per centimeter. Up to 1 Ghz,

tions of the display can be magnified 100 times. The instrument has a dynamic range of ± 1.6 volts over the whole attenuator setting, even at 1 mv per division.

The scope is 9 by 13 by 19 inches, weighs 40 pounds, and draws 80 volt-amperes.



Somewhat sensitive. The 3400 has eight sensitivity settings, running from 1 millivolt to 200 millivolts per centimeter.

there are 60 decibels of isolation between its two channels. Rise time is 200 picoseconds, and trigger sensitivity is 3 millivolts.

Sweep speed is adjustable between 1 nanosecond and 20 microseconds per centimeter, and por-

The 3400 is quite versatile when it comes to displaying its inputs. Channel A or B can be shown alone; A and B together; A and inverted B; A plus B; A minus B; or A vertical and B horizontal. The use of electronically-compensating

MOST DIVERSIFIED LINE OF 512 STOCK RELAYS FOR CUSTOM APPLICATIONS
general purpose • telephone type • dry reed • mercury-wetted contact • industrial power • plug-in
coaxial • hermetically sealed • time delay • solid state • printed circuit • latching • high voltage

Magnecraft[®]

STOCK RELAYS

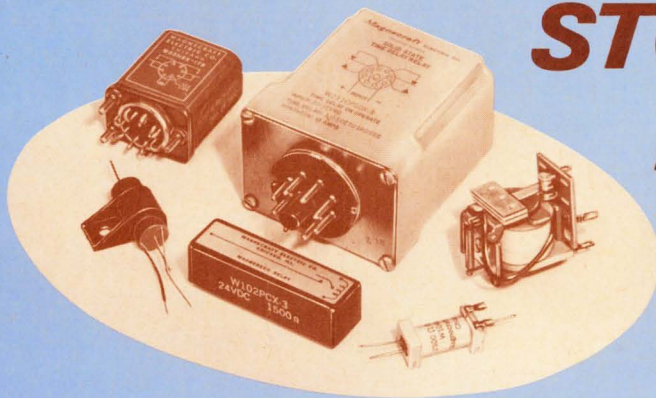

**CATALOG
NO. 271**

*Specifying relays? You need our
new catalog of 512 stock relays for
immediate delivery. Send for it!
And see us at IEEE—Booth #3E11.*

MAGNECRAFT ELECTRIC CO. • 5575 N. LYNCH AVE. • CHICAGO, ILL. 60630 • 312 282-5500 • TWX 910-221-5221

**BUY
A KIT
SAVE
A LOT**

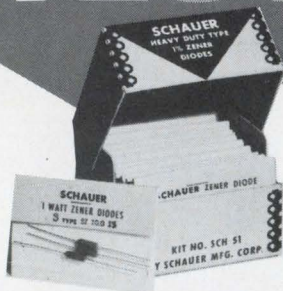

1% TOLERANCE
SCHAUER
1-WATT ZENERS
A \$54.57 value, just

\$24.50

Kit contains a 51-piece assortment of SCHAUER 1% tolerance 1-watt zeners covering the voltage range of 2.7 to 16.0. Three diodes of each voltage . . . packaged in reusable poly bags. Stored in a handy file box. Rating data sheet included.

Use these Schauer zeners over and over in laboratory prototypes as well as in precision test equipment. Contact your distributor or order direct. Schauer is #2 in the plastic encapsulated diode field, highest quality, the industry's lowest prices!

Semiconductor Division
SCHAUER
MANUFACTURING CORP.

4514 Alpine Ave., Cincinnati, Ohio 45242
Telephone: 513/791-3030

amplifiers keeps the scope linear over the 8-by-10-cm area of its cathode-ray tube.

Channels A and B are output signals, each with an amplitude of 0.5 volt per cm. Coming from 1-kilohm BNC connectors, they can easily drive a recorder.

Mother-board/sister-board type of construction is used, and this permits easy servicing of the 3400.

The entire instrument can be disassembled in less than 5 minutes with a screwdriver, according to Philips engineers.

Initially, the scope will be manufactured in Holland. When sales volume builds up, a U.S. production line will be started.

Philips Electronic Instruments, 750 South Fulton Ave., Mount Vernon, N.Y. [384]

Telling all the angles

Pin for pin. An all solid state device, the angle-position indicator with a gas-tube display is identical, as far as inputs and outputs go, to the electromechanical unit at the bottom. But the newer unit is twice as accurate and 10 times as fast.



Replacing gears, shafts, and mechanical switches with transistors and integrated circuits sounds like a surefire way to shrink an instrument. But it ain't necessarily so.

Back in 1962, North Atlantic Industries Inc. decided to build a solid state version of its electromechanical angle-position indicator. This instrument uses a control transformer (a synchro whose output depends on the position of its shaft and the input to its stator), a differential amplifier, a servo, and a mechanical counter to convert resolver-to-synchro data into a display of a shaft's angular dis-

placement. With solid state parts, reasoned North Atlantic designers, the indicator would have a higher accuracy, put out more readings in a given time, and track higher angular velocities.

They were right. But their prototype also was five times bigger and six times as expensive. It seemed that after years of use and redesign, the mechanical parts in these indicators were as small and inexpensive as possible, and duplicating their functions and size was expensive and complicated.

But the job is just about done. In its 8525, North Atlantic is offer-

BIG CAPABILITIES IN A SMALL PACKAGE: SUWA SEIKO PRINTING MECHANISM

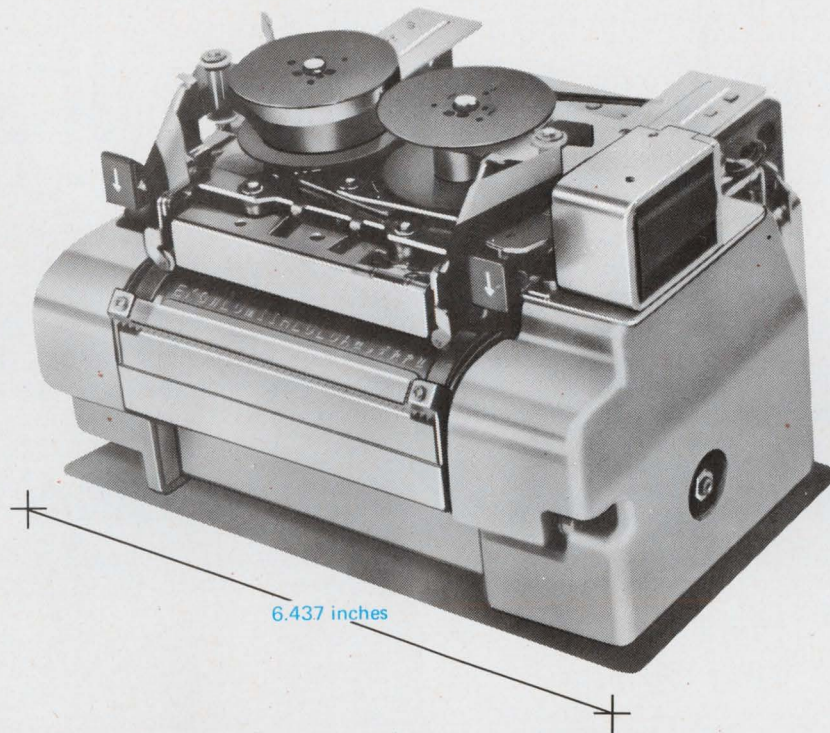

- * Ideal printing speed
- * Simplified structure assures durability, reliability
- * Low power consumption
- * Wide range of applications
- * Low cost, high performance
- * Compact size

Developed by
SUWA SEIKOSHA CO., LTD.
Manufactured by
SHINSHU SEIKI CO., LTD.
Sales Agents in NORTH AMERICA, EUROPE & Other Countries
C. Itoh & Co., LTD.

NORTH AMERICA

C. ITOH & CO., (AMERICA) INC.
NEW YORK
245 Park Ave., New York, N.Y. 10017, U.S.A.
Tel.: 976-7900 (Area Code 212)

LOS ANGELES
One Wilshire Bldg. (Suite 805), Wilshire at
Grand, Los Angeles, Calif. 90017, U.S.A.
Tel.: MA 7-3175 (Area Code 213)

CHICAGO
69 W. Washington St., Chicago, Ill. 60602, U.S.A.
Tel.: 263-0404 (Area Code 312)

OTHER OFFICES
SAN FRANCISCO, MONTREAL, TORONTO

EUROPE

LONDON
C. ITOH & CO., LTD.
Tel.: 606-7311

DUSSELDORF
C. ITOH & CO., G.m.b.H.
Tel.: 10726 (9 lines)

PARIS
C. ITOH ET CIE
Tel.: RIC 01-69 (4 lines)

MILANO
C. ITOH & CO., ITALIANA S.p.A.
Tel.: 877541

NETHERLAND: ROTTERDAM
C. ITOH & CO., LTD.
Tel.: (010) 13-73-00

OTHER OFFICES
HAMBURG, OSLO, ZURICH

more than a power supply

You get more than a power supply when you specify this or any Hewlett Packard power supply. An international network of 220 sales/service offices are at your disposal . . . the most comprehensive service manuals detailing every aspect of the supply from theory and operation to troubleshooting . . . protection circuitry including an internal overvoltage "crowbar" to safeguard delicate loads, standard on this Low Voltage Rack (LVR) Series. OUTPUTS: 10V @ 20, 50, or 100A; 20V @ 10, 20, or 50A; 40V @ 3, 5, 10, 30, or 50A; 60V @ 3 or 15A. RIPPLE AND NOISE: typically 200 μ V rms, 10mV p-p. Remote Programming and lots more. Prices start at \$350.

and you can customize it with these options...

- 10-Turn Output Voltage and Current Controls • Chassis Slides
- 3-Digit Graduated Decadial for Voltage or Current • 115V, 208V, or 230Vac Inputs • 50Hz Input.



HEWLETT  PACKARD

POWER SUPPLIES

Over 100 power supplies are described in the 1970 HP Electronics Catalog. Write for your copy.

100 Locust Avenue, Berkeley Heights, New Jersey 07922 (201) 464-1234

hp DC POWER

From $10\mu\text{V}$ to 4000V
From $1\mu\text{A}$ to 2000A
From \$90 to \$3,500
From manual to computer controlled.



LOW COST SUPPLIES

Compact laboratory power supplies can be stacked or rack mounted. Choose from 6 well-regulated models: 10V @ 1A; 25V

@ .4A; 50V @ .2A. Three Constant Voltage/Current limiting models — \$90. Three Constant Voltage/Constant Current models — \$115.

Constant Voltage/Constant Current with Automatic Crossover, Remote Programming, Remote Sensing, Auto-Series or Parallel, Optional Internal Over-voltage "Crowbar"

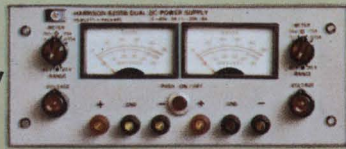

MEDIUM POWER / TRANSISTOR REGULATED

Precisely regulated. Programming speeds as fast as $500\mu\text{s}$. 20 models: 7.5V @ 3 or 5A; 10V @ 10A; 20V @ 1.5, 3, 5, or 10A; 30V @ 1A; 40V @ .75, 1.5, 3, or 5A; 60V @ 1 or 3A; 100V @ .75A; 160V @ .2A; 320V @ .1A. \$144 to \$395.

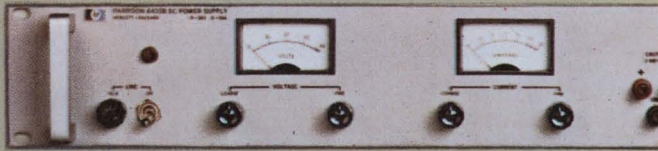

MEDIUM POWER / SCR REGULATED

8 models: 20V @ 15 or 45A, 40V @ 10 or 25A; 60V @ 5 or 15A, 120V @ 2.5A; 600V @ 1.5A. \$360 to \$550.

HIGH POWER/SCR REGULATED

12 Models: 4V @ 2000A; 8V @ 1000A; 18V @ 500A; 36V @ 300A; 64V @ 150A; 110V @ 100A; 220V @ 50A; 300V @ 35A; 600V @ 15A. \$1275 to \$3500.

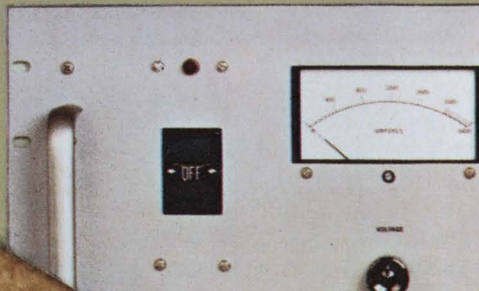

... design relies heavily on IC's,
precision-built transformer ...

ing a plug-for-plug replacement for its 8025 electro-mechanical indicator in automatic test systems, ground support equipment for aircraft, and other instrumentation. With a height of $1\frac{3}{4}$ inches and width of 9 inches, the 8525 is the same size as the older unit. But its accuracy is 0.05° compared with 0.1° for the 8025; it takes 1 second, not 10 seconds, to update its display following a 180° -step input; and it tracks at up to 500° per second, 20 times faster than the 8025. And since it has a digital-signal output, it fits into automatic systems. The unit will make its debut at the IEEE Show, Booth 2H26.

Of course North Atlantic doesn't expect all its customers to switch to the 8525; its price is \$2,500, while the electromechanical unit goes for \$1,000.

North Atlantic isn't the only company making solid state angle-position indicators, but does lay claim to making the smallest. "The next size available," says director of engineering Jack Heaviside, "is twice the height (of the 8525) and has the same width." Heaviside points out also that the 8525 has a five-digit readout, allowing the instrument to display from 000.00° to 359.99° .

The workings of the 8525 are analogous to those of the 8025. In the electromechanical unit, the control transformer compares the incoming synchro/resolver data with the position of its shaft which is geared to a mechanical counter. The signals from the transformer go through an amplifier to a servo, whose shaft is connected by a gear train to the transformer's shaft. The error signal turns the servo's shaft, rotating the transformer's shaft and the counter's number wheels until a null point is reached.

Things work much the same way in the 8525. As Heaviside explains it: "The solid state version (of the control transformer) compares the synchro data to a digital word, and, just like its mechanical brother, produces an error voltage whenever the digital word and the synchro data aren't in correspondence." From there on, things are fairly similar. The error voltage is fed to an amplifier. The amplifier is not used to drive a servo; it drives a phase-sensitive detector which drives a logic circuit that in turn drives a voltage-controlled oscillator. Explains Heaviside: "Whereas the mechanical servo delivers a shaft rotation to a mechanical counter, the pulse train (from the vco) is delivered to a digital counter which produces a digital word that's translated through some logic circuitry into a Nixie readout. That same digital word is presented back to the solid state control transformer."

Besides relying heavily on IC's, North Atlantic engineers shrunk the 8525 by keeping down the size of the solid state control transformer. "The key to success in this business," says Heaviside, "is to find clever ways to make that device. It's built with precision transformers, which we wind our-

Au! Ag! Pt! Pd!

... And other precious metal alloys for microelectronic design!

PARTIAL LIST OF AVAILABLE ALLOYS & SOLDER PREFORMS

88% Gold 12% Germanium (Eutectic Alloy)
Strip and solder preforms in all sizes

80% Gold 20% Tin (Eutectic Alloy)
Strip, wire and solder preforms in all sizes

Gold with .1 to 1.2% Antimony
Wire, strip and solder preforms all sizes

Gold — .05% Min. Phosphorous
Wire, strip and solder preforms all sizes

95% Gold 5% Nickel
Wire, strip and solder preforms all sizes

Gold and up to .5% Arsenic
Strip and solder preforms all sizes

Silver with .1 to 1.2% Antimony
Wire, strip and solder preforms all sizes

Silver — .1% Min. Phosphorous
Wire, strip and solder preforms all sizes

95% Silver 5% Nickel
Wire, strip and solder preforms all sizes

Silver and up to .5% Arsenic
Strip and solder preforms all sizes

Special alloys produced on request at minimum charge.

Precious Metals in 99.9% Pure, 99.99% Pure, and 99.999% Pure.

The most modern production techniques, the latest refining methods and the best equipped research laboratories make Williams your one best source for all precious metals and their alloys.

Available in ultra-high purity sputtering discs, preforms, foil ribbon, tape, wire, sheet and other forms.

Write for our complete Precious Metals Catalog and Specification Sheets.



WILLIAMS PRECIOUS METALS

2980 MAIN ST. BUFFALO, NEW YORK 14214
Division of Williams Gold Refining Co., Inc.

selves, and precision resistors, IC's, operational amplifiers, and semiconductor switches. The complexity and number of parts that one must introduce in a solid state control transformer to achieve a given accuracy and size depend

very much on the ingenuity of the engineer doing the design—ingenuity in packaging components as well as in electrical and mechanical design."

North Atlantic Industries Inc., 200 Terminal Drive, Plainview, N.Y. [382]

Logic on the quiet side

Getting the tougher problem solved first usually is considered good strategy—particularly if someone else is going to provide the solution. That's what Datascan Inc. does for systems engineers with its Wrap-X printed-circuit board.

The equipment engineer, especially one in an industrial firm with limited experience in integrated circuits, can order the complex-function cards from Datascan, and

with the back-plane approach in small systems and prototype quantities of large systems. Marketing will be aimed at original-equipment manufacturers, who will be encouraged to use logic functions more extensively in measurement, control, machine tool, processing, and other types of industrial equipment.

The back-plane approach, Datascan points out, requires complex

At the ready. Logic module has 16 wire-wrap sockets for insertion of IC packages. Wrap-X card was designed to compete with back-plane approach in small systems and in prototype work.

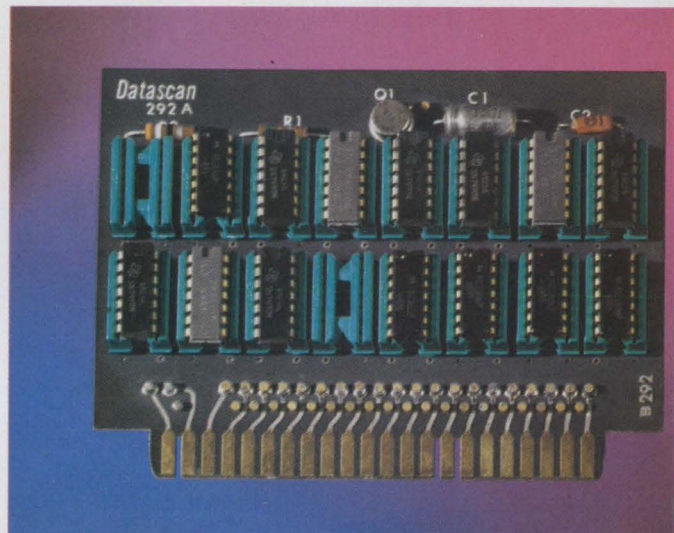

then do the simple logic himself. Datascan also will completely wire-wrap a system from a block diagram or schematic, using computer-aided design and wire-wrapping techniques. The Wrap-X module contains 16 wire-wrap sockets for either 14- or 16-pin dual in-line IC's. It is mechanically compatible with more than 100 standard function cards—such as decimal converters, comparators, and shift registers—of the DTL, HTL and TTL logic families.

Datascan's Wrap-X, which will be introduced at the IEEE Show (Booth 2E51) will be competing

wire-wrap interconnections to replace the function cards, necessitating an extensive run list and many hours of engineering design time. In the Wrap-X system, on the other hand, most of the interconnect is plated. Also in the back-plane approach, discrete components and IC's must be housed on plug-in platforms, each of which requires a physical design before the run list can be generated. These hours of design and drafting time are eliminated by using Wrap-X and standard cards which already have been designed and laid out.

One feature of this approach is

**CANADIAN MARCONI COMPANY
ANNOUNCES...**

A NEW CONCEPT IN TELECOMMUNICATIONS

**GIVING YOU CHANNEL-BY-CHANNEL EXPANDABILITY
...LOWEST COST...HIGHEST RELIABILITY**



PIPE LINE TELEMETRY



INDUSTRIAL COMPLEXES



TELEPHONE SYSTEMS



RAILWAY SIGNALING
AND COMMUNICATIONS



COMPUTER DATA LINKS

The MCS-6900 is a modular, 120 channel capacity, PCM microwave radio relay system which provides unsurpassed communication flexibility for all voice or data transmission systems.

- **TRUE PAY-AS-YOU-GROW EXPANDABILITY.** No longer must you add channels in blocks of 12 or more when expanding. MCS-6900 lets you add even one channel at a time — and at a fraction of present costs.
 - **EQUIPMENT COMPATIBILITY.** MCS-6900 interfaces directly with existing telephone systems because it is Bell T-1 and WECO-D1 compatible.
 - **SYSTEM ECONOMY.** PCM system eliminates costly group equipment required for FDM systems. In addition the MCS-6900 eliminates expensive common PCM multiplex equipment. What's more, drop and insert capabilities at repeater stations cost 50% less than the same capabilities in existing systems.
 - **FIELD-PROVED.** The MCS-6900 was developed from existing Canadian Marconi Company equipment, techniques and systems field-proved in the most hostile of environments. Six basic functional units, grouped as required, make up the entire system.
- For complete information write today to Telecommunications Division, Canadian Marconi Company, 2442 Trenton Ave., Montreal 301, Quebec or call (514) 343-3411.

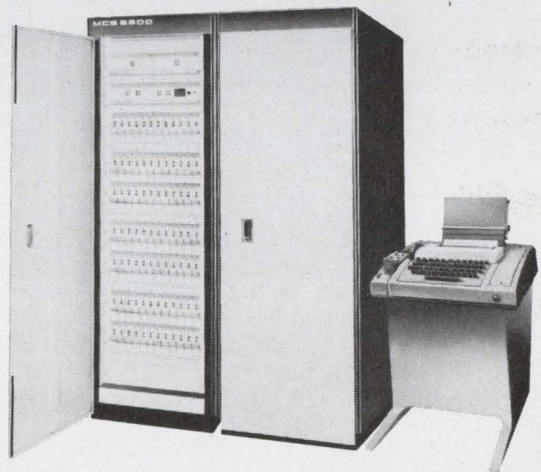

CANADIAN MARCONI COMPANY 
TELECOMMUNICATIONS DIVISION

Circle 173 on reader service card

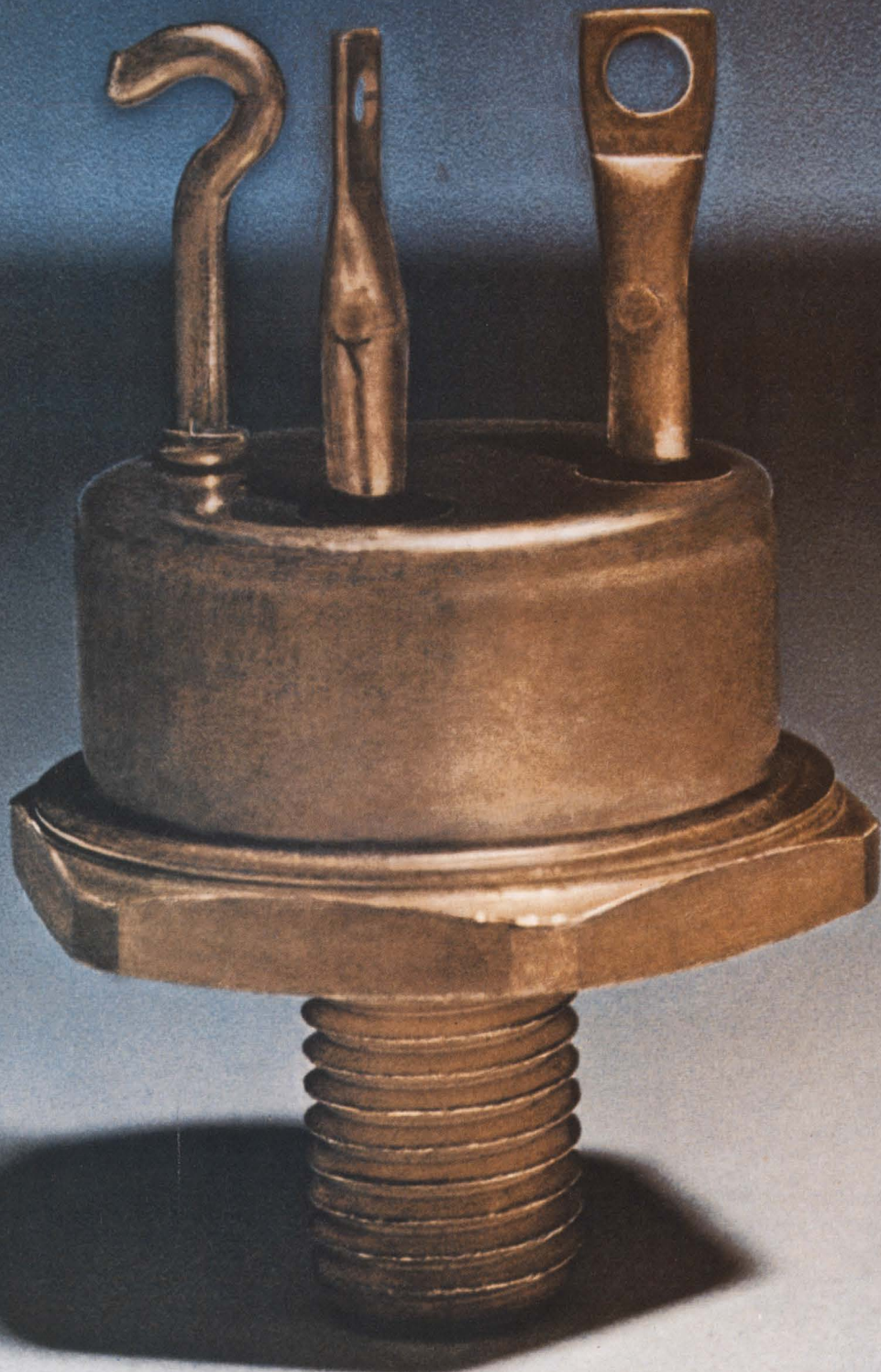

Bargain driver.

**Westinghouse epi
base power transistors
save you a driver stage
or cut driver
transistor cost.**

How do we do it? Through an exceptional combination of frequency, power and gain capability. Our devices give you maximum turnoff time ($t_s + t_f$) of 1.15 microseconds or less, with high gain, particularly at high currents—up to 75 amps. Hard solder construction minimizes possibility of thermal fatigue. Hermetically sealed in popu-

lar TO cases, these devices are manufactured by military processing to maximum reliability. Broad SOAs too.

Other hard facts: total switching time of .95 to 1.75 microseconds maximum, currents 2-75 amps, voltage 40-375 volts, power 35-260 watts. So drive a bargain: contact Westinghouse Semiconductor Div., Youngwood, Pa. 15697.

You can be sure...if it's Westinghouse



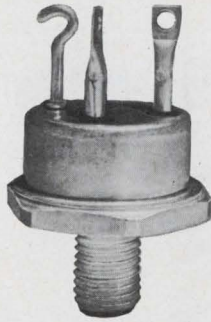

Westinghouse Industrial Semiconductor Distributors

Alabama
 ACK Semiconductors, Inc.
 Birmingham 205 322-0588
 Electronic Wholesalers, Inc.
 Huntsville 205 534-5722

Arizona
 Hamilton Electro of Arizona
 Phoenix 602 272-2601
 Kierulff Electronics Corp.
 Phoenix 602 273-7331

California
 Newark Electronics
 Inglewood 213 674-8440
 Hamilton Electro Sales
 Los Angeles 213 870-7171
 K-Tronics
 Los Angeles 213 685-5888
 Elmar Electronics, Inc.
 Mountain View 415 961-3611
 Hamilton Electro Sales—North
 Mountain View 415 961-7000
 Hamilton Electro of San Diego
 San Diego 714 279-2421

Colorado
 Electronic Parts Co.
 Denver 303 266-3755
 Hamilton Denver
 Denver 303 934-5508

Connecticut
 Cramer Electronics, Inc.
 North Haven 203 239-5641

Florida
 Cramer Electronics, Inc.
 Fort Lauderdale 305 566-7511
 Electronic Wholesalers, Inc.
 Orlando 305 841-1550
 Hall-Mark Electronics Corp.
 Orlando 305 855-4020

Georgia
 Specialty Distributing
 Atlanta 404-873-2521

Illinois
 Semiconductor Specialists, Inc.
 Chicago 312 279-1000
 Pace/Avnet Electronics
 Schiller Park 312 678-6310

Indiana
 Fort Wayne Electronics Supply, Inc.
 Fort Wayne 210 742-4346
 Ra-Dis-Co.
 Indianapolis 317 637-5571
 Radio Distributing Co.
 South Bend 210 287-2911

Maryland
 Pyttronic Inc.
 Baltimore 301 727-5100
 Hamilton Electro Sales
 Baltimore 301 668-4900
 Cramer Electronics, Inc.
 Rockville 301 424-2700

Massachusetts
 Cramer Electronics, Inc.
 Newton 617 969-7700
 Schweber Electronics
 Waltham 617 891-8484

Michigan
 Semiconductor Specialists, Inc.
 Detroit 313 255-0300

Minnesota
 Semiconductor Specialists, Inc.
 Minneapolis 612 866-3434
 Stark Electronic Supply
 Minneapolis 612 332-1325

Missouri
 Electronic Components for
 Industry Co.
 Kansas City 816 412-8400

Electronic Components for
 Industry Co.
 St. Louis 314 647-5505
 Hall-Mark Electronics Corp.
 St. Louis 314 521-3800

New Jersey
 General Radio Supply Co., Inc.
 Camden 609 964-8560
 Angus, Inc.
 Moorestown 609 235-1900
 Sterling Electronics, Inc.
 Perth Amboy 201-HI.2-8000

New Mexico
 Kierulff Electronics Corp.
 Albuquerque 505 247-1055

New York
 Stack Industrial Electronics
 Binghamton 607 723-6326
 Summit Distributors
 Buffalo 716 884-3450
 Cramer/Eastern
 East Syracuse 315 437-6671
 Schweber Electronics
 Long Island 516 334-7474
 Milgray Electronics, Inc.
 New York 212 989-1600

Ohio
 Sheridan Sales
 Cincinnati 513 761-5432
 Sheridan Sales
 Cleveland 216 524-8120
 Hughes-Peters, Inc.
 Columbus 614 294-5351
 Mentrionics, Inc.
 Mentor 216 946-3058

Oklahoma
 Hall-Mark Electronics Corp.
 Tulsa 918 835-8458

Pennsylvania
 Cameradio Company
 Pittsburgh 412 391-4000

South Carolina
 Sawyer Electronics Corp.
 Greenville 803 235-0438

Texas
 Hall-Mark Electronics Corp.
 Dallas 214 231-6111
 Midland Specialty Co.
 El Paso 912 533-9555
 Hall-Mark Electronics Corp.
 Houston 713 781-6100
 Lenert Company
 Houston 713 225-1465
 The Altair Co.
 Richardson 214 231-5166

Washington
 Hamilton Electro Sales of the
 Pacific Northwest
 Seattle 206 624-5930
 Kierulff Electronics Corp.
 Seattle 206 725-1550

West Virginia
 Charleston Electrical Supply
 Company
 Charleston 304 346-0321

Wisconsin
 Taylor Electric Company
 Milwaukee 414 964-4321

Canadian Westinghouse
 Hamilton, Ontario 416 528-8811

Westinghouse Electric International
 London, S.W. 1 Whitehall 2704
 New York 212 692-3322

Westinghouse Semiconductor Division
 Youngwood, Pennsylvania 15697

use of a Datascan development called dynamic decoupling. It's a transistor-capacitor decoupling circuit that reduces the system's susceptibility to noise on the power supply lines; and replaces the widely used capacitive-only decoupling. When several transistors in the system switch at the same time, this circuit prevents the signal from being reflected back to the power source.

The Wrap-X approach was developed for use in Datascan's own

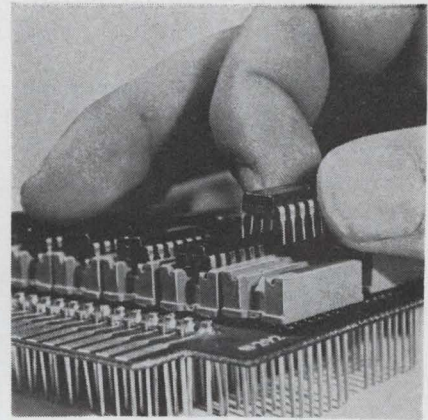

Plug-in logic. Dual in-line IC is inserted into Wrap-X card.

test equipment, and minimization of system noise was one of the prime goals. In addition to dynamic decoupling, a design decision was made to buck the trend and put test points at every circuit node that the user would want to test. The usual procedure—placing test points across the top of the module—adds capacitive noise as well as limiting the number of points, the company points out.

In addition, Datascan says, wiring for a large back-plane unit is more extensive than the Wrap-X system because all of the plated interconnect on the function cards must be hard-wired. This means a greater chance of noise problems—summing junctions and other low-level signal points must be run over a relatively long distance, and may be mixed with digital wiring.

Wrap-X also offers standard advantages of all plug-in techniques, including ease of troubleshooting and isolation of system parts.

Datascan Inc., 1111 Paulison Ave., Clifton, N.J. 07013 [385]

On-card regulator dissipates 5 watts

IC can handle an entire circuit board without external transistors; applications seen in computer, test, control, and display systems

The main attractions of on-card voltage regulation are that it eliminates the hard-to-predict voltage drop from centrally regulated power transmitted over long wires, and it averts noise pickup on the long road from the power supply to the individual integrated circuits. Providing a voltage-regulator IC on each circuit board in the system avoids these problems.

However, one difficulty with on-card regulation is that available IC's have limited power output. As a result, they can regulate power for only a limited number of IC's on the card, so the designer must add one or more power transistors and associated drive circuits.

General Electric Co.'s PA264 and PA265 are intended to solve this problem. With five watts of

power-dissipation capability, they can regulate an entire circuit card without external power transistors. The only difference between the two IC's is the maximum rated input voltage: The PA264 takes 25 volts, and the PA265 37 volts. George W. Hippisley Jr., an application engineer with GE's integrated circuits project, characterizes the devices as "high-power, medium-

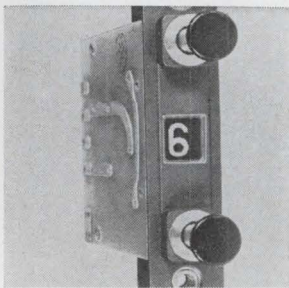

Push-button rotary switches are built in accordance with the environmental requirements of MIL-S-22710. Switching action may be in either direction by depressing one of two buttons on the front of the switch. Units are available in 8, 10, or 12 positions and in all standard codes. Electrical rating carries 3 amps continuous. Janco Corp., 3111 Winona Ave., Burbank, Calif. [341]

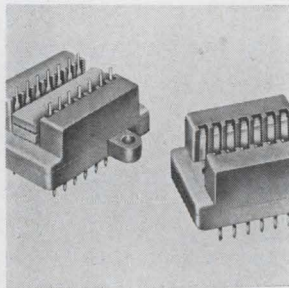

Inverted dual-in-line sockets series 121-0102 are production test sockets designed for high-speed hand testing of dual-in-line devices. Devices are inserted with leads up. Manipulating leads into individual contacts is thus eliminated. Sockets accept all standard 14- and 16-lead DIP's having 0.300-in. row spacing. Barnes Corp., 24 N. Lansdowne Ave., Lansdowne, Pa. 19050 [342]

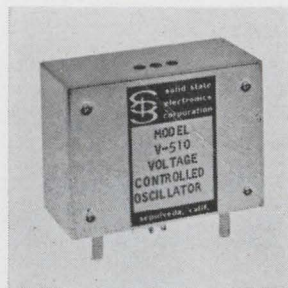

Voltage controlled oscillator V-510 is for accurate conversion or varying analog d-c voltage to a linearly proportional sine wave frequency. Standard units are calibrated for operation over a range from 400 hz to 70 khz within IRIG bands 1 to 18 ($\pm 7.5\%$ frequency deviation) and A to E ($\pm 15\%$ deviation). Solid State Electronics Co., Rayen St., Sepulveda, Calif. [343]

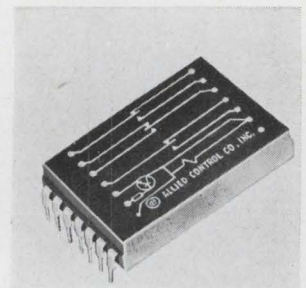

Electrical specifications of the Tri-R dry reed relay include: switching time, 1 msec; contact rating, 10 w resistive maximum, 50 v d-c or 0.5 amp d-c; power requirement, 75 mw/pole. Minimum life expectancy is 2×10^7 operations. Height is 0.275 in., making it suitable for mounting on p-c boards spaced as close as 0.5 in. Allied Control Co., Plantsville, Conn. 06479 [344]

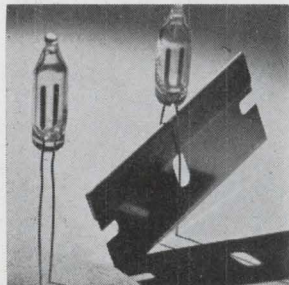

Neon tube A039A offers the close tolerance in breakdown voltage characteristics and the high leakage resistance to provide a high degree of repeatability when used in RC timing circuits. Breakdown voltage is 66-72 v in the dark. Leakage resistance is greater than 20,000 megohms. The tube is 27/32 in. long. Signalite Inc., 1933 Heck Ave., Neptune, N.J. 07753 [345]

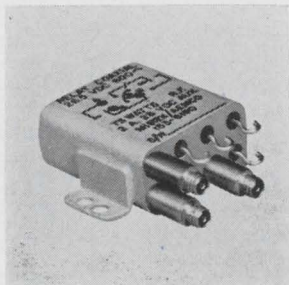

Microminiature coaxial relay type 153, offering the convenience of strip-line or bracket mounting and packaged in the 0.400 x 0.800 x 0.800 in. crystal can, can switch 2,000 Mhz at vswr's of 1.2. It matches a 50-ohm impedance system, with crosstalk of 35 db at 2,000 Mhz. R-f contacts can switch 75 w. Aemco Division of Midtex Inc., 10 State St., Mankato, Minn. 56001 [346]

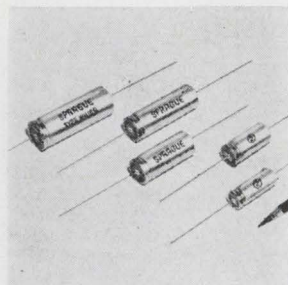

Low-cost miniature and standard tubular electrolytic capacitors types WH11D and WH18D are designed especially for use in consumer electronic equipment and allied applications. Both devices feature an all-welded construction and are designed for operation over a temperature range of -55° to $+125^\circ\text{C}$. Sprague Electric Co., 35 Marshall St., North Adams, Mass. 01247 [347]

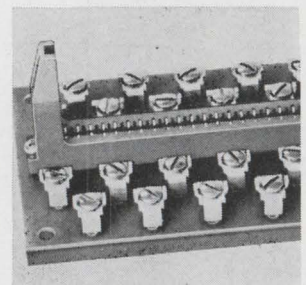

Edge connector interface socket model 22 is designed to bridge the gap between p-c technology and factory control panel installation. It allows the insertion of a 22-pin p-c board into a panel-mounted connector with screw terminals. This eliminates soldering, wire-wrap connections and p-c mounting panels. Farmer Electric Products Co., Tech Circle, Natick, Mass. 01760 [348]

How can such a little guy uphold the family reputation?

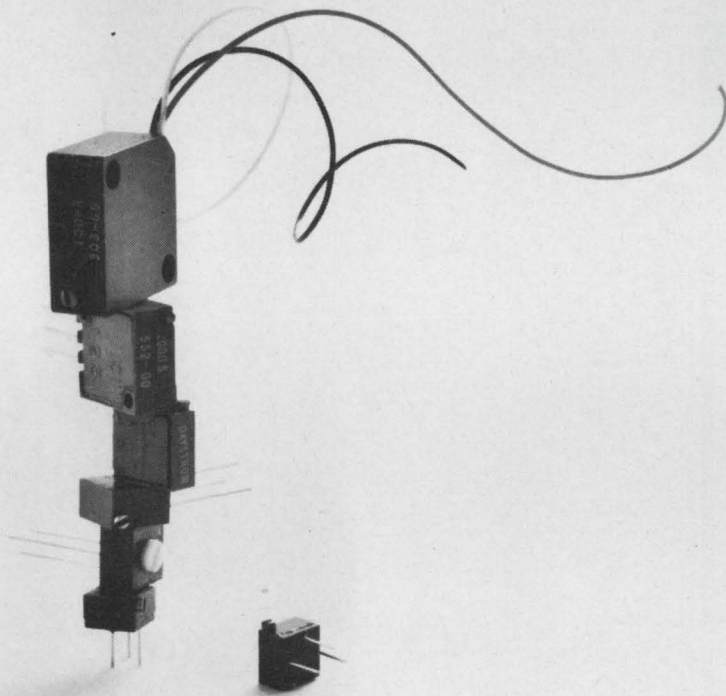

Our new 561/562 series are true Squaretrim® potentiometers down to the last quarter inch. As the smallest members of this distinguished family, they have to live up to a bigger reputation than other pots their size.

They do. We made sure.

We gave them the same high quality element that makes our military pots so reliable . . . the same tight $\pm 5\%$ tolerance . . . the same wide 10 ohms to 20K standard resistance range and -55°C to $+150^{\circ}\text{C}$ temperature

range. We even designed them to meet all environmental requirements of MIL-R-27208, like their larger military brothers.

Models 561 and 562 $\frac{1}{4}$ " Squaretrims are available in three configurations, top or side adjustable, and they give you a generous 13:1 adjustment ratio. You wouldn't expect a general-purpose pot to have all these features and still be reasonably priced. But it's just another example of how our Squaretrim family supports its reputa-

tion as the biggest name in value for the smallest thing in pots.

They're in stock now at Weston Potentiometer distributors. Or ask us about special resistance values, data sheets, evaluation samples.

The little guys.

WESTON COMPONENTS DIVISION,
Archbald, Pennsylvania 18403, Weston
Instruments, Inc. a Schlumberger company

WESTON®



NORTON[®] MAGNETIC HEADS

MULTITRACK ERASE RECORD PLAY

Send now for complete technical literature.

NORTON

ASSOCIATES, INC.

10 Di Tomas Court, Copiague, N.Y. 11726
Phone: 516 598-1600

Circle 211 on reader service card

AUTORANGING AC VOLTMETER



Model M-175

100_rV ~ 300V rms
6Hz ~ 1MHz

NF M-175 Voltmeter equipped with such excellent features makes quick and accurate measurement of RMS voltage. Correct voltage range to be measured is clearly shown in the illuminated indicator. The down-range button makes the manual range-selection possible. Equipped with constant and normal amplitude monitoring output as 60 dB (max.) gain low-noise amplifier. Recommended for use in laboratory and production line.

ACCURACY: $\pm 3\%$ at 1KHz
RESPONSE: 20Hz to 100KHz $\pm 3\%$
INPUT IMP: 1M Ω 30pF typically
OUTPUT: Constant and Normal amplitude
DISTORTION: $< 1.5\%$, 1KHz
AMP. GAIN: 60dB Max.
DIMENSIONS: 149(W) \times 198(H) \times 276(D)mm
NET WT.: 2.8kg

NF

NF CIRCUIT DESIGN BLOCK CO., LTD.

Head Office: 36-12, 2-chome, Sanno, Ohta-ku, Tokyo
Phone: 03-775-0411
Factory: 18-11, 4-chome, Sanno, Ohta-ku, Tokyo
Phone: 03-772-8721

... design suited to minicomputers, calculators as well as to large digital systems ...

regulation, low-price" IC's. They can furnish output current in excess of 1 ampere, with 500 to 800 milliamperes typical of most applications. The combined regulation—line, load, and temperature—provided is better than that required for transistor-transistor logic, Hippisley says. He expects them to find use as on-card regulators in large digital systems using diode-transistor logic, TTL, or metal oxide semiconductor circuits. They also will be used to provide central regulation in smaller systems such as desk top calculators, minicomputers, test equipment, industrial control (including high-threshold logic equipment), communication equipment, and displays.

The PA264 and PA265 are enclosed in eight-lead plastic packages with two heat sink tabs, similar to the package that GE uses for its 5-watt audio amplifier [*Electronics*, Nov. 25, 1968, p. 111]. The leads are staggered so that they can be inserted in the printed circuit cards, and external heat sinks can readily be attached to the tabs, along with other components, during flow soldering of the cards.

The voltage regulator requires an external reference voltage which can be furnished in several ways, as shown in the diagram. The direct-reference method uses a low-voltage zener diode as the reference. With this technique, the regulator's output can be returned to the zener to provide feedback, making the output independent of the line voltage. Unfortunately, low-voltage zeners don't have temperature compensation, and therefore neither does the voltage-regulator output.

The divided-down reference uses a higher-voltage zener, which has temperature compensation. But in this case the output voltage can't be fed back if it's lower than the zener breakdown.

A third alternative is to use a central, distributed reference. With this method, line and temperature variations can be compensated at the central voltage source. The big advantage is that it eliminates the board-to-board variations that

would occur with individual zeners on each circuit board.

The voltage regulators should have heat sinks to keep them cool. The thermal resistance from output-transistor junction to the heat sink tabs is 11°C per watt, and the power derating is based on a maximum junction temperature of 125°C. Some possible heat sinks include copper heat-radiation fins or even the equivalent amount of printed-circuit board copper. In systems with vertical cards and forced-air cooling, it's sometimes possible to cool the regulator by soldering the heat sink tabs to the circuit-board copper.

Prices are \$4 for the PA264 and \$4.50 for the higher-voltage PA265 in quantities of 100 to 999.

General Electric Co., Integrated Circuits Project, Electronics Park, Syracuse, N.Y. 13201 [349]

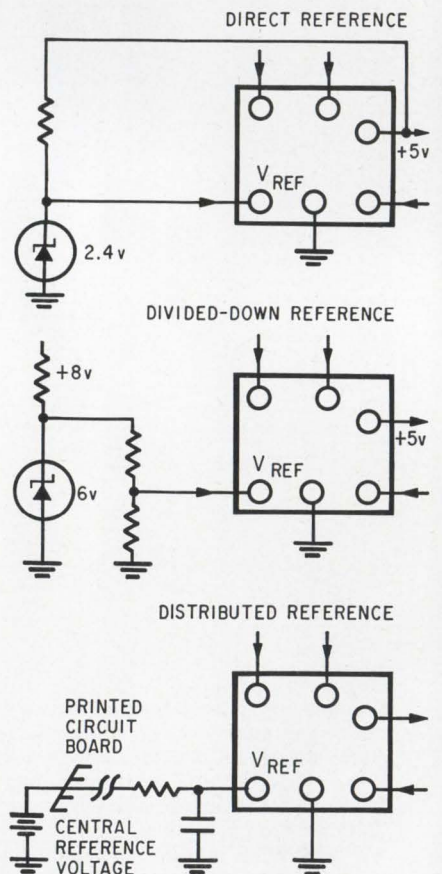

Options. The on-card regulators require an external reference voltage, which can be supplied by a low-voltage zener, a high-voltage zener, or by a central reference.

Introducing the 7½ minute prototype.

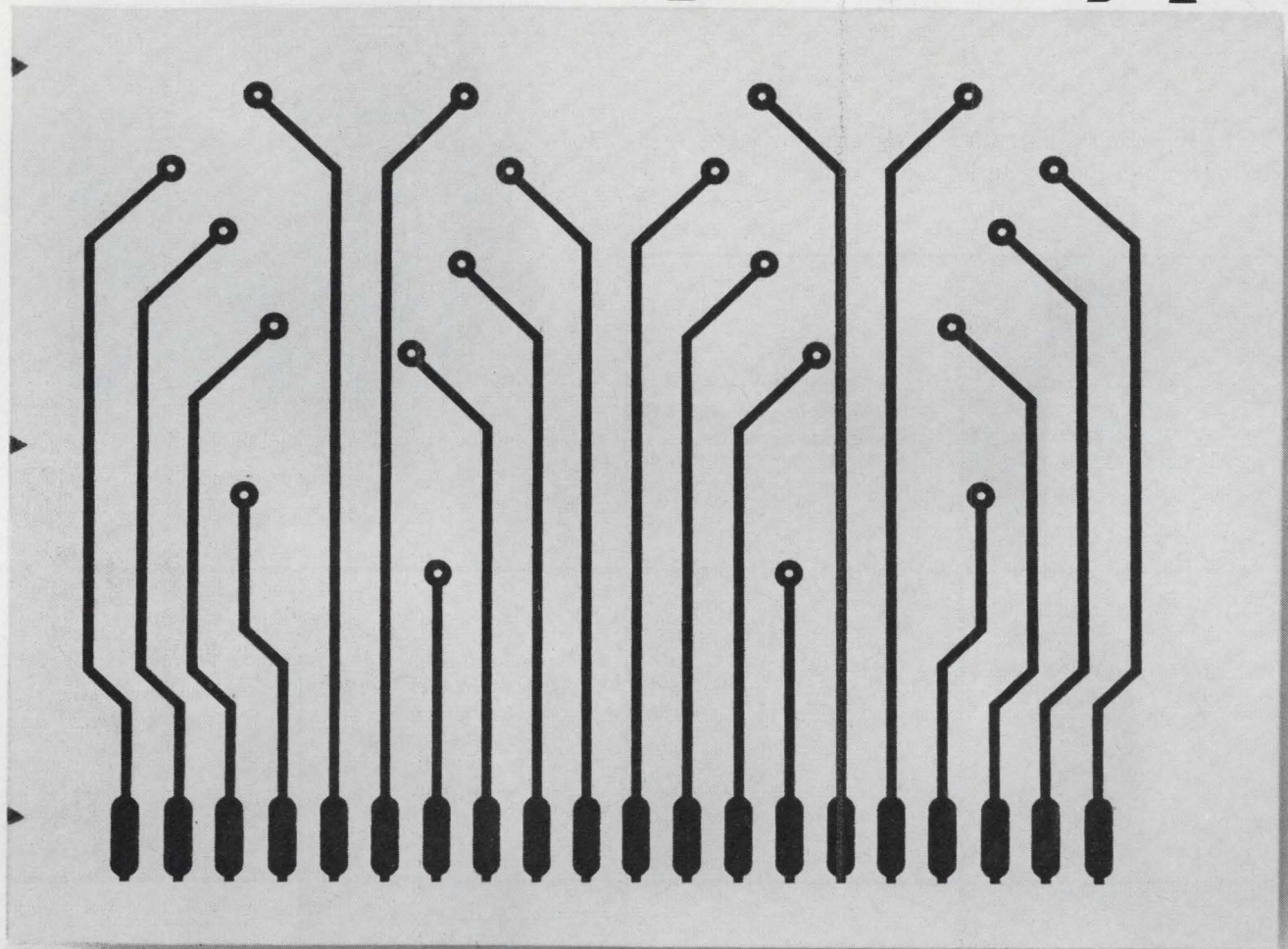

Getting prototype circuit boards used to be the biggest nuisance in design projects.

It took a lot of man-hours, expense, and a lot of space for bulky, awkward equipment.

No more. With Xerox Standard Equipment, chemical resist images can be transferred to copper-clad laminates and prepared for conventional etching—in 7½ minutes flat.

For just pennies per prototype.

And there are no wet, messy chemicals (the xerographic process is

completely dry).

No air-controlled darkroom (the Xerox equipment can be set up in a small corner almost anywhere).

No need for highly-trained technicians (most people can learn to handle it in just 60 minutes).

Of course, the 7½ minute prototype is only one of the ways you can use Xerox Standard Equipment.

If you have another 7½ minutes, we'll explain some of the others. Write Dept. BC14, Xerox Corporation, Rochester, New York 14603.

XEROX

Play Sierra's "Pick-A-Signal-Generator" Game

Place an X in each square describing a feature you think desirable. Playing time: 15 seconds.



<p>Selection of units offering variable frequency coverage (in MHz) of 50-200, 200-500, 500-1000, 1000-1800, and 1800-2500.</p>	<p>Front-panel metering of grid and cathode current.</p>		
<p>Maximum power output from 70 watts (at 400 MHz) to 15 watts (at 2500 MHz)</p>	<p>Logging scale for accurate frequency resetting.</p>	<p>All-solid-state circuitry (save for final output tube, which takes only a few minutes to replace).</p>	<p>Monitor output 35 dB down from main signal.</p>
<p>Front-panel metering of power output.</p>	<p>Built-in capability for CW, internal and external square wave, and pulse-modulated outputs.</p>	<p>Automatic protection against no-load conditions.</p>	<p>Compact—$6\frac{3}{4} \times 10 \times 18\frac{1}{2}$ inches (23 inches with optional 220-volt transformer).</p>

A potentially profitable pastime for players who make a serious living of testing and calibrating VHF, UHF, and microwave power-measuring equipment.

We could have called the game Monopoly, but somebody else already had it. After all, we are the only company with a monopoly so far on high-power signal generators having all the features above.

So we'll call our game "Sierra." Sort of fits.

The rules are simple. All you do is check off those features that would appeal to you in a commercial line of high-power signal generators. Begin when ready.

For complete information telling why Sierra's "Pick-A-Signal-Generator" game can make you a winner—and isn't a game to us — write Philco-Ford Corporation, Sierra Electronic Operation, 3885 Bohannon Drive, Menlo Park, California 94025. Or call (415) 322-7222, extension 329.

PHILCO 

THE BETTER IDEA PEOPLE IN INSTRUMENTATION

MOS memory has 800-nsec access time

Read-write unit aimed at scratchpad and buffer storage markets;
basic 512-word-by-4-bit module is expandable up to 16,384 words

The paramount position held by core memories is being assailed more and more by semiconductor memory component manufacturers ready to compete for small systems—scratchpads and buffer memories. This is the arena chosen by the Systems division of Electronic Arrays Inc., for its first standard product, the Mostak I random-access read-write memory.

The basic module consists of 16 metal oxide semiconductor random-access memory chips, each with 128 bits, that form a card containing 512 words by 4 bits. Transistor-transistor logic level compatibility is provided for both inputs and outputs. The components are Electronic Arrays' own EA1400 RAM's. The basic 512-word-by-4-bit module is believed to be a first in

the MOS memory subsystem business; its access time is 800 nano-seconds.

To make the basic module function as a 2,000-word memory, a strobe pulse and a write pulse or write control are the only external circuitry required. Each board contains all the required address, decoding, and clock driver circuitry. The strobe pulse is needed for

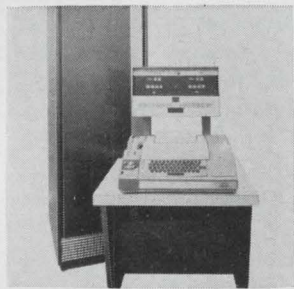

Algomatic 16 is a direct digital control and data handling system providing closed-loop control and data logging for 16 loops, expandable in 16-channel increments up to 128. Through its software, it processes the loop data using a control algorithm tailored to each loop. Data logging may be either full time or only for off-limit values. Research Inc., Box 24064, Minneapolis [361]

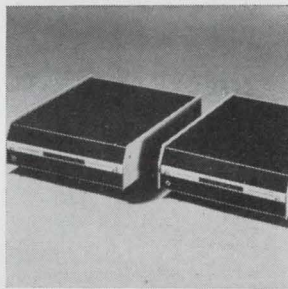

Compact, medium-speed modems TT-202 and TT-201 are available in p-c card form, rack mounted or desk mounted in a 11½-x-14½-x-3½-in. cabinet. They are suited for integral installation in terminals operating up to 1,800 and 2,400 bps respectively. The basic cards are 12 x 6 in. Tel-Tech Corp., 9170 Brookville Rd., Silver Spring, Md. [362]

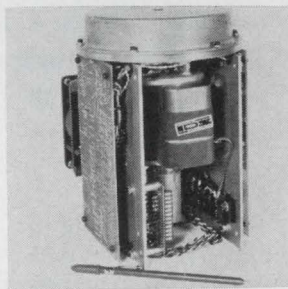

Disk memory system series 8100 has been developed to fit the mini-computer market segment that requires a combination of a compact and lightweight package with a bit storage capability approaching 145 K bits of storage. Package is 9 x 9 x 10½ in. Access time is 8.5 msec utilizing TTL interfacing. Information Data Systems Inc., E. Eight Mile Rd., Detroit, Mich. [363]

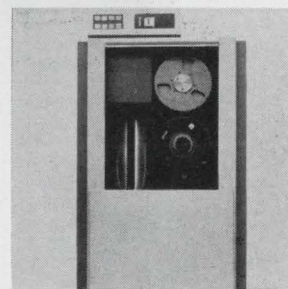

Magnetic tape subsystem MTS-110 is intended for initial entry into magnetic tape processing. It uses a single channel controller and as many as four tape handlers. A single capstan drive in the handlers provides high reliability and minimum tape wear. Unit has a seven-track recording density of 200 or 556 characters/in. General Electric Co., Schenectady, N.Y. [364]

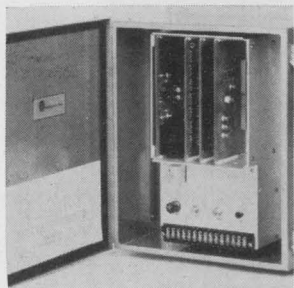

Peak memory unit PMJ400 furnishes a continuous electrical signal that is proportional either to the peak height or the integration of the peak of a desired component in pulsed or noncontinuous output analyzers. Standard output is an analog signal, 10 v full scale at a maximum of 50 ma. Accuracy is 0.1% of full scale. Omnitronix Inc., P.O. Box 988, Houston 77001 [365]

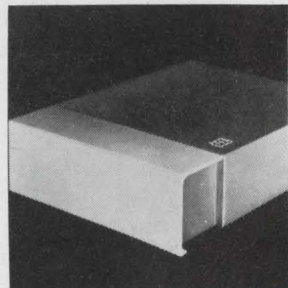

Parallel-input simplex modem 402C accepts 5, 6, or 8-level tape reader inputs and converts the data to parallel tones for transmission over the public telephone network. The modem is used in data collection systems and can be adapted to most parallel information applications. It operates at a speed of 75 characters/sec. General Data Comm Industries, Norwalk, Conn. [366]



Data link model 2600 makes it possible for all types of digital instruments and systems to communicate directly with in-house or time-sharing computers via hard-wire, Teletype printers or data couplers. A single-channel 2600 with 5 BCD digits, constants, internal multiplexer and ASCII code conversion costs \$3,300. Sagetec Corp., 822 N. Hollywood Way Burbank, Calif. [367]

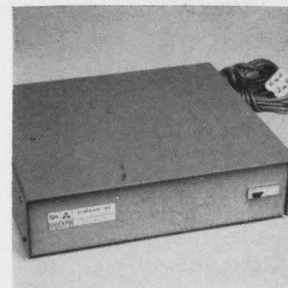

Error-minimized, digitally implemented data set called Modem Pack transmits and receives asynchronous signals at rates from 0 to 1,800 bps and eliminates customary adjustments for frequency and delay equalization. It features 8-msec turn-on/turn-off times for quick polling. Input/output levels meet EIA RS-232B. Sanders Associates Inc., 8700 Main St., Buffalo, N.Y. [368]

What happened when doctors and engineers got together:

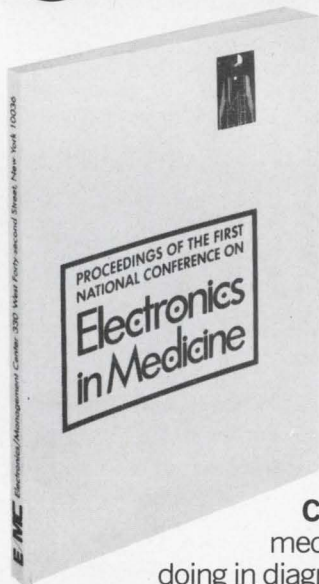

Doctors told engineers how they were using electronics and revealed their most urgent needs. Engineers described and demonstrated their newest equipment for diagnosis, treatment, and prevention. And hinted at things to come.

Their complete dialogue, with illustrations, makes pretty informative reading on a vital and growing market.

Here are some of the things it contains:

Computers: How they're joining the medical team. What computers are doing in diagnosis. In communications. The small computer as a paramedical aid.

Instrumentation: What's needed. What's available. Patient management. Protection. Standards and safety.

Electronics in the Hospital: The surgeon, the hospital, the instruments. What the administrator wants. Prescription for large-scale health care. The surgery department.

Electronics/Management Center
330 West 42nd Street, New York, N.Y. 10036

Enclosed is \$12 for a copy of the Proceedings of the First National Conference on Electronics in Medicine.

Send the Proceedings and bill me later. P.O. # _____

Name _____

Company _____

Address _____

City _____ State _____ Zip _____

writing data into the memory and for refreshing it. This can be provided by three bipolar integrated circuits, and the write control or pulse-shaping circuit is provided by a fourth IC, external to the memory board.

The memory can be expanded to provide up to 16,384 words of four bits—a size that would require 32 of the basic Mostak I boards and occupy a volume of 6¾ by 4¼ by 12 inches. Access time is increased by 10 nanoseconds per board. Word length is expandable in four-bit increments, and no external decoding is required for expansion in the bit direction. To expand the word size, only external board-select circuitry is needed. James Nicklas, director of the systems division, says this would amount to one transistor-transistor logic IC to provide board selection for 2,048 words.

At 2,048 words, Nicklas sees the Mostak I finding applications in such equipment as printer buffers in which random-access rather than shift-register storage is desired. Electronic Arrays is using the modules at 512 words and up to 48 bits in its own read-only memory simulator [*Electronics*, Nov. 24, 1969, p. 41].

Peter Glaser, manager of product engineering, says the MOS memory module has these advantages over core memories: it offers non-destructive readout; data and address do not have to be made available at the same time in the write cycle as they do with core memories; it will operate over 0 to 50°C without special compensation; and circuit requirements are minimal compared with cores.

Floyd Powell, project engineer for the Mostak I, adds that it is less expensive to expand the memory in the bit direction than it is with cores, "because the more bits there are in a core memory, the more sense amplifiers and drivers are required."

The basic Mostak I card will sell for \$400 each in 25-unit quantities, and delivery time is 90 days, about two weeks for prototype quantities. The Mostak I will be followed by Mostak II in about three months. This will be a 1,024-word-by-eight-bit memory system.

Systems division, Electronic Arrays, Inc., 9060 Winnetka Ave., Northridge, Calif. 91324 [369]

Energy: find it, freeze it.

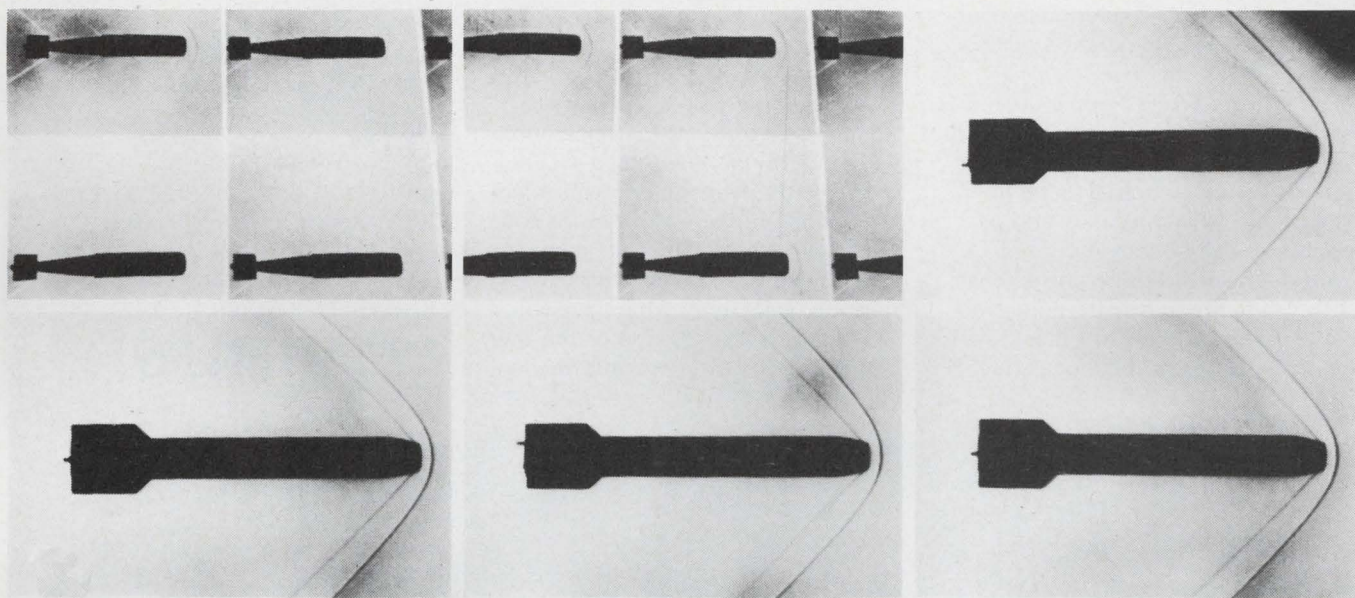

Photograph it.

Some kinds of energy traces can be so subtle, so elusive, only photography can track them down and hold them frozen for analysis. Kodak can help—with the data-collecting and recording power of photography.

Use it to compress and expand time. To explode minutiae into macrocosm. To peer beyond normal ballistics into the fireball of explosion. Or to

explore the interior of the human body through fiber optics.

At Kodak, thousands of scientists and engineers have designed the recording medium of many of today's data-recording and photographic monitoring systems. In many instances, they did it in collaboration with specialists in nonphotographic disciplines. Specialists who realized

photography's potential as a data-collecting medium. So chances are the materials and technology you need are available right off the Kodak shelf. Talk to a Kodak photographic specialist. Call (716) 325-2000, ext. 5114. Or write:

Instrumentation Sales
EASTMAN KODAK COMPANY
Rochester, N.Y. 14650

Photographs show shock waves of projectile in flight.

Kodak

The most for your money: in 8 channel recorders, it's the new Brush® 480.

Minimum cost per channel and maximum data presentation.

That's the cost/performance package called the Brush 480... most versatile, least expensive 8-channel recorder of its kind.

It's the economical solution to your problem of analyzing eight variables on a common time base.

The Brush 480 has eight 40 mm channels, two event markers, and twelve pushbutton-controlled chart speeds that run from 0.05 to 200 mm/second. It's available as a compact portable or can be rack mounted.

Although small in size, the 480 has all those familiar Brush exclusives. Like a patented pressurized ink system that puts crisp rectilinear traces

right into the paper. So there's no smudging, no puddling. And messless throw-away ink cartridges can be replaced in minutes.

The 480 comes factory-calibrated and, thanks to our special pen-position servo system, we guarantee 99½% accuracy. Frequency response at 50 divisions is flat within $\pm 2\%$ of full scale from d-c to 40 Hz.

And the Brush 480 is compatible with our multi- and single channel signal conditioners so you can select the conditioning best suited for your measurements, whether it's temperature, pressure, strain, voltage, current, position, velocity or what have you.

The Brush 480. It's one of the few bargains left. For more information,



write for bulletin 934-18. Brush Instruments Division, Gould Inc., 3631 Perkins Avenue, Cleveland, Ohio 44114, or Rue Van Boeckel #38, Brussels 14, Belgium.

GOULD BRUSH

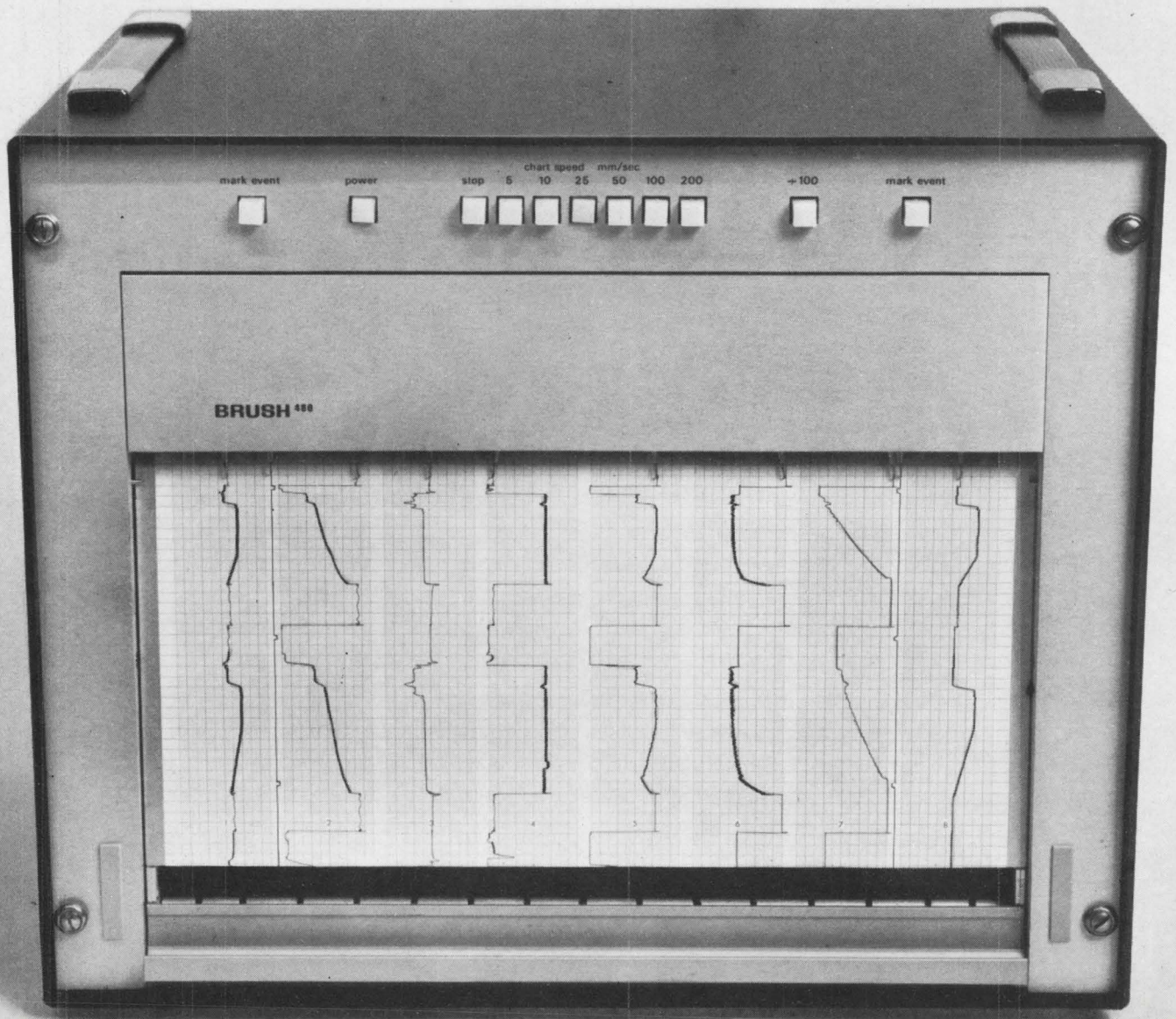

Deposition-rate accuracy reaches 0.1%

All controls are digital in automatic system for IC work; programers can be stacked to handle up to seven cycles

Digital techniques have become fairly commonplace in control applications, but one exception is vacuum deposition equipment for integrated circuits.

"It's a relatively small market, and there hasn't been much talent applied to the problem; most of the analog systems on the market were developed four or five years ago and are now obsolete," says

Cleve R. Hildebrand, vice president and director of engineering for Kronos Inc., maker of the ADS-1, an all-digital-input automatic deposition system.

Key elements in the system are its programer and controller, which are used in conjunction with a digital film-thickness monitor and thickness transducer introduced earlier by Kronos.

There are 21 digital thumb-wheel switches and 11 pushbutton switches on the programer, for setting soak power and time, deposition rate and time, shutter control, and other inputs.

Rate start-and-stop times from zero to 10,000 seconds are set with eight thumbwheels, for a 1-second resolution. The control period can be extended to 100,000 seconds

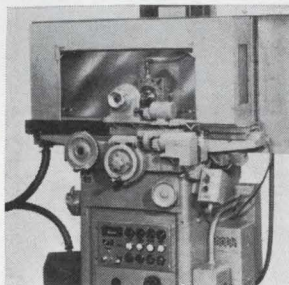

Slicer-dicer machine model 612 produces minuscule silicon chips and wafers with ± 0.0001 in. dimensional accuracy to assure proper function of integrated circuitry. It uses a table speed from $\frac{1}{4}$ to 5 ipm, and a cross feed control within ± 0.0001 in. which allows repeat grinding or cutting on a production basis. Reid Brothers Co., 140 Elliott St., Beverly, Mass. 01915 [421]

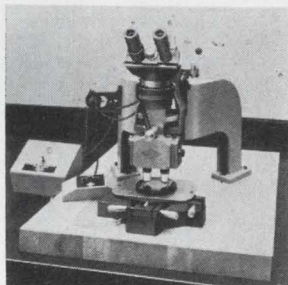

Zero-backlash instrument provides fast, foolproof microinch alignment of masks to wafers prior to exposure. This positioning is in all three axes (X, Y, and angle). Microinch movements can be made while observing mask and wafer positions through a dual-objective microscope. Each objective can be focused independently. The Jade Corp., Philmont Ave., Huntingdon Valley, Pa. [422]

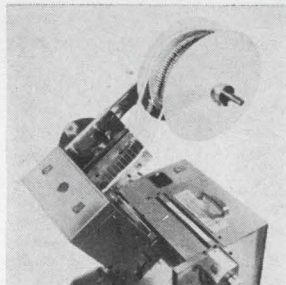

Automatic de-reeler DR-3 is used to process lead tape components in conjunction with component processing equipment. The unit also operates independently and may be used for de-taping purposes only. The DR-3 is designed to process all the standard lead tape pitches at high speed with no adjustment required. Heller Industries Inc., 18 Microlab Rd., Livingston, N.J. 07039 [423]

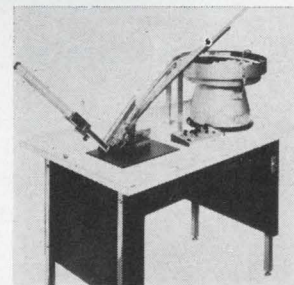

Dual in-line package insertion machine SM-2000 accepts DIP's from "sticks", loads them into carriers, and stacks the loaded carriers into magazines for further automated processing. It runs at rates up to 3,600 pieces per hour. Except for manual loading of carriers and DIP circuits, it is fully automatic. Weltek Div., Wells Electronics Inc., S. Main St., South Bend, Ind. [424]

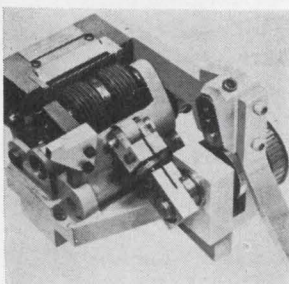

Axial lead straightener assures fast and continuous production and superior product uniformity of electronic components while eliminating human error and possibility of damage to component or boards. It increases component output from 100 per hour by manual operation to more than 3,000 per hour. Niagara Electro-Mechanical Corp., 1280 Erie Ave., North Tonawanda, N.Y. 14120 [425]

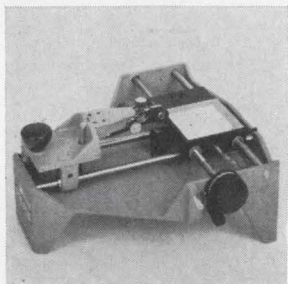

Manual scriber model 1300c is for ceramic substrates. It incorporates an alignable vacuum chuck for holding the substrates. The chuck has precise 90° rotational stops so criss-cross scribing can be quickly done without removing the work-piece. Price is \$880; delivery, 1 to 3 weeks after receipt of order. Mechanization Associates, 140 S. Whisman Rd., Mountain View, Calif. [426]



Automatic r-f batch sputtering system is for IC and semiconductor manufacturers. It can process up to 4,000 square inches of substrate material in one pump-down. Typical sputtering rates for electronic applications vary from 100 to 400 angstroms per minute for nonmetallic materials and 300 to 700 angstroms for metals and alloys. Materials Research Corp., Orangeburg, N.Y. [427]

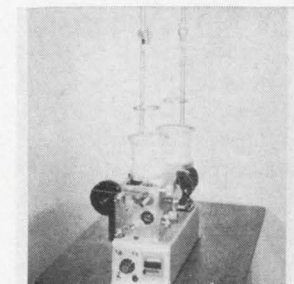

Front-loading bobbin winder model CHM-2 is a two-spindle machine. Infinite traverse adjustment is possible through a direct action adjustable cam. The machine combines automatic overrun compensation with automatic positioning of the guide for the start of the next coil without operator attention. Coil Winding Equipment Co., Railroad Plaza, Oyster Bay, N.Y. 11771 [428]

**WHAT MAKES
THIS NEW
TEMPERATURE/
HUMIDITY CHAMBER
SUCH A
MONEY-SAVER?**

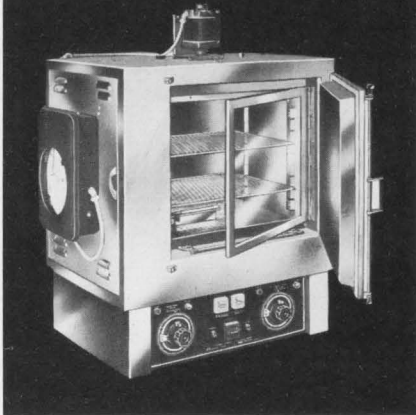

(IT'S AIR-COOLED!)

By using ordinary air for cooling instead of costly conditioned water, Blue M's unique HUMIDIARE Temperature/Humidity Chambers save thousands of gallons of water (and hundreds of dollars) a year.

Yet, they're the most accurate and reliable units ever developed for long-term high temperature/humidity testing. Ideal for such steady state requirements as MIL-202C, Method 103B, Condition D — continuous operation for 56 days. Control humidity from 40% to 98% ($\pm 1/2\%$), temperature from $+12^{\circ}\text{C}$. above ambient to $+93^{\circ}\text{C}$. ($\pm 1/2^{\circ}\text{C}$).

Key to their performance is the inherent reliability of independent wet and dry bulb POWER-O-MATIC 60® Proportioning Control Systems. This patented control assures straight-line performance, operates continuously without attention almost indefinitely.

If you want to save money, but need a quality, reliable temperature/humidity cabinet, remember the Blue M HUMIDIARE. Write: Blue M Engineering Company, A Division of Blue M Electric Company, Corporate Headquarters, Blue Island, Illinois 60406.



with 10-second resolution. The shutter is independently controlled. Four thumbwheels are available to set the opening time, and another four for closing time.

Thickness range for the system is zero to 200 kiloangstroms, with 1 Å resolution; accuracy is $\pm 0.05\%$ of full-scale plus resolution. The deposition rate is from zero to 1,000 Å per second, with a resolution of 1 digit or 0.01 Å per second. Rate accuracy is $\pm 0.1\%$ of full-scale plus resolution. The best competing analog systems have a rate control accuracy of only about 0.5%, according to Hildebrand.

A single programmer can automatically repeat multiple-step depositions of the same material; or up to seven programmers can be stacked together to continuously perform up to seven different deposition cycles for different materials in any desired sequence. All the programs are connected to the controller by a single data bus. The number of input wires is minimized by internal multiplexing. Only 24 wires per programmer are required. Output of the system is displayed in four-digit numerics.

The controller is a special-purpose digital computer which uses a four-bit byte, and is serial by decade and parallel by bit within the decade. Heart of the controller is a central arithmetic unit. All inputs are multiplexed to the arithmetic unit before going to the controller; this permits the stacking option.

The controller generates a program of thickness against time as a function of inputs received from the programmer. It compares the time displayed on the system clock with the start/stop signals and then compares the actual deposition thickness received from a thickness monitor with the control signal. From this, the error signal is digitally determined, and a digital-to-analog conversion is performed to obtain an analog error signal. This signal determines the amount of power which must be applied to the source or electrode for the material being deposited.

Price for the system is \$4,810, delivery time is 30 days.

Kronos Inc., 1647-7 West Sepulveda Blvd., Torrance, Calif. 90501 [429]

THIS SPACE CONTRIBUTED BY THE PUBLISHER

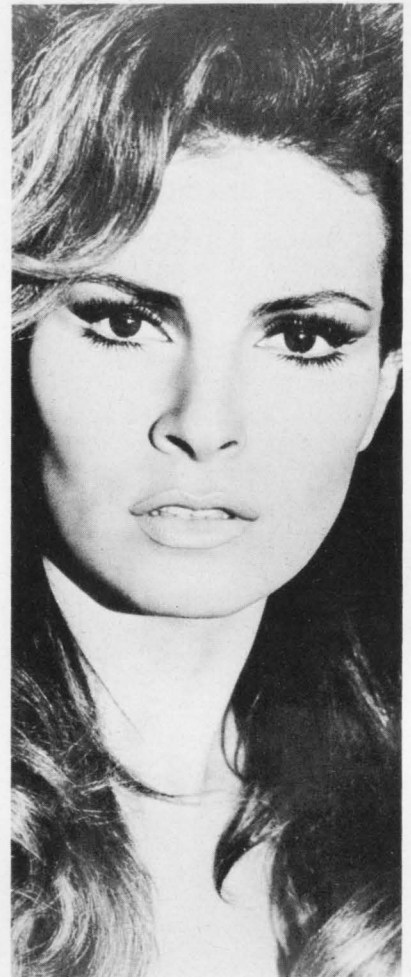

Photo: O'Neill

Miss Raquel Welch

Learn the seven warning signals of cancer. You'll be in good company.

1. Unusual bleeding or discharge.
2. A lump or thickening in the breast or elsewhere.
3. A sore that does not heal.
4. Change in bowel or bladder habits.
5. Hoarseness or cough.
6. Indigestion or difficulty in swallowing.
7. Change in size or color of a wart or mole.

If a signal lasts longer than two weeks, see your doctor without delay.

And be sure to have a health checkup once a year, no matter how well you may feel.

Fight Cancer with a checkup and a check

American Cancer Society



LAUNCHING
THE
SPECTACULAR



IN ELECTRICAL and
ELECTRONICS ENGINEERING



4 Floors of Exhibits

NEW YORK COLISEUM / 10 a.m.-8 p.m. 4 Days.

50 Technical Sessions

NEW YORK HILTON / 10:00-12:30; 2:00-4:30 5 Days.

Registration — Good all days — Technical Sessions and exhibits. In and out privileges. IEEE Members \$4.00. Non-members \$8.00. Ladies \$2.00. High School Students \$3.00 if accompanied by adult (One student per adult). Thursday only — limit of 3 students per adult.

IEEE INTERNATIONAL
CONVENTION and EXHIBITION
MARCH 23-26, 1970



IEEE
70

Circle 212 on reader service card

Keyboard designers, meet Feathertouch. The Gordos* reed switch pushbutton.

Actual size

Feathertouch reduces the size of your keyboard up to 20%; pick magnet design minimizes interaction between adjacent switches; rigid lead frames assure hermetic reliability. Optional adapters accept the key-top of your choice and you can choose from three mounting arrangements in a flat or 10° base. An orientation rib assures perfect alignment and pressure relief pads allow the use of a 1/16" pc board.



All parts are ultrasonically bonded. Get Feathertouch-smooth, wobble-free feel in five basic contact configurations.

Send for complete technical specs, or call for personal service.

*The people who know switches best.

GORDOS
CORPORATION
250 Glenwood Avenue
Bloomfield, N. J. 07003
Phone: 201-743-6800

Circle 213 on reader service card

**PROVEN RELIABILITY—
SOLID-STATE POWER INVERTERS,
over 260,000 logged operational hours—
voltage-regulated, frequency-controlled,
for missile, telemeter, ground support,
135°C all-silicon units available now—**

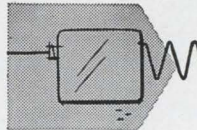
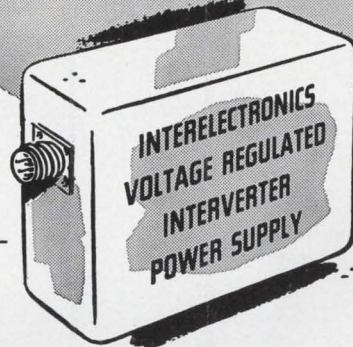

Interelectronics all-silicon thyatron-like gating elements and cubic-grain toroidal magnetic components convert DC to any desired number of AC or DC outputs from 1 to 10,000 watts.

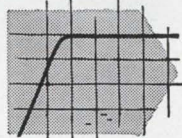

Ultra-reliable in operation (over 260,000 logged hours), no moving parts, unharmed by shorting output or reversing input polarity. High conversion efficiency (to 92%, including voltage regulation by Interelectronics patented reflex high-efficiency magnetic amplifier circuitry.)

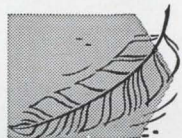

Light weight (to 6 watts/oz.), compact (to 8 watts/cu. in.), low ripple (to 0.01 mv. p-p), excellent voltage regulation (to 0.1%), precise frequency control (to 0.2% with Interelectronics extreme environment magnetostrictive standards or to 0.0001% with fork or piezoelectric standards.)

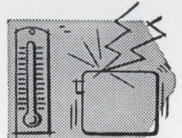

Complies with MIL specs. for shock (100G 11 mlsc.), acceleration (100G 15 min.), vibration (100G 5 to 5,000 cps.), temperature (to 150 degrees C), RF noise (1-26600).

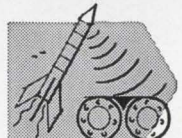

AC single and polyphase units supply sine waveform output (to 2% harmonics), will deliver up to ten times rated line current into a short circuit or actuate MIL type magnetic circuit breakers or fuses, will start gyros and motors with starting current surges up to ten times normal operating line current.



Now in use in major missiles, powering telemeter transmitters, radar beacons, electronic equipment. Single and polyphase units now power airborne and marine missile gyros, synchros, servos, magnetic amplifiers.

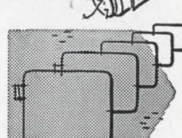

Interelectronics—first and most experienced in the solid-state power supply field produces its own all-silicon solid-state gating elements, all high flux density magnetic components, high temperature ultra-reliable film capacitors and components, has complete facilities and know how—has designed and delivered more working KVA than any other firm!

For complete engineering data, write Interelectronics today, or call 914 Elmwood 8-8000.

INTERELECTRONICS CORP.

700 U. S. Route 303 Congers, New York 10920

Circle 187 on reader service card

187

Quick-Change Artists

(Barnstead cartridge demineralizers meet any need from 5 to 3,000 gph. Some are both reusable and disposable.)

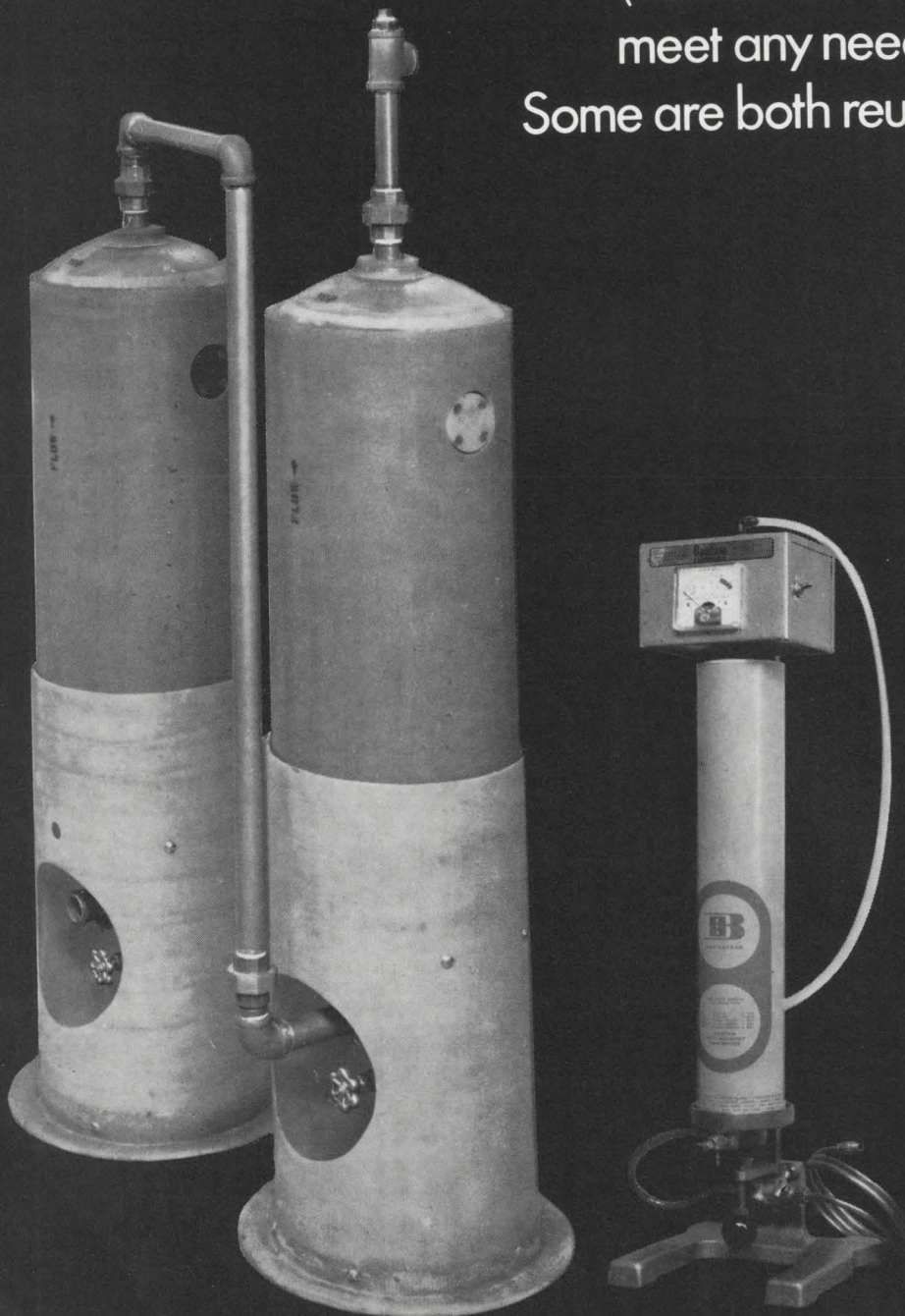

Need demineralized water in your laboratory . . . or on your production line? We can supply cartridge demineralizers and quickly replaceable cartridges for any purpose from the industry's most complete line.

Little, low-cost throw-aways you attach to a faucet. 5 to 25 gallon-per-hour "Bantam" lab units, with a purity meter on top (superior to color-change or "idiot light" indicators that don't really tell you what's going on). Portable compact "Suprcartridges"® operating at pressures to 100 psi and flow rates to 3,000 gph. Standard mixed-bed, organic removal, oxygen removal, cation removal, and special types. We make them all. And with many of our larger cartridges you have the options of disposal (a must for hazardous wastes) . . . reactivation by us . . . or regeneration in your plant, using Barnstead equipment.

We also manufacture a huge line of demineralizers which can be regenerated, plus approximately 200 different water stills.

Write for the complete story on any of these products to The Barnstead Co., Division of Ritter Pfaudler Corp., 225 Rivermoor St., Boston, Mass. 02132.

Barnstead
A DIVISION OF RITTER PFAUDLER CORPORATION

The almost-everything op amp IC

Transductance is made a variable quantity, so device can be tailored to wide variety of jobs

Voltage gain is the parameter that is generally used to describe the forward-gain characteristic of an operational-amplifier IC. Transconductance is usually disregarded. By taking a somewhat different tack—emphasizing transconductance and, in fact, deliberately making it a variable quantity, engineers at RCA have developed an op amp with an extremely wide range of applica-

tions and functions.

In the CA3060 operational transconductance amplifier, transconductance is a function of bias. By varying the bias, therefore, it's possible to control output current, power consumption, slew rate, input resistance, input bias current, and input offset current to suit the particular application. The integrated circuit can function as a

conventional op amp—as an inverting or noninverting amplifier, integrator, differentiator, or summing amplifier. In addition, the linear variation of parameters with bias, and the ability to maintain a constant d-c level between input and output make the CA3060 suitable for many nonlinear functions—as a mixer, multiplier, or modulator.

The IC contains three operational

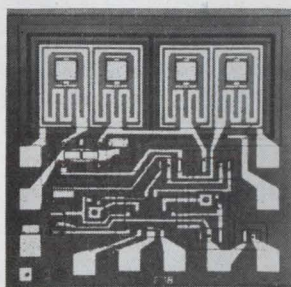

Bipolar/MOS driver-switches come complete on one chip. They are the DG122 two-channel differential switch with driver, the S13001 special function driver switch and the S13002 spdt switch with driver. Driver inputs are comparable with 5-v DTL, TTL, and RTL logic. The switches handle analog signals up to 20 v peak-to-peak. Siliconix Inc., 2201 Laurelwood Rd., Santa Clara, Calif. [436]

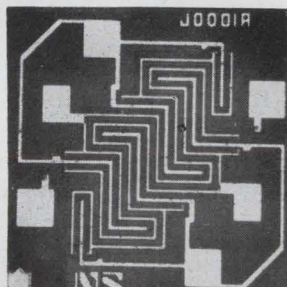

Monolithic, N-channel, dual FET's series FM3954 are matched by design. Features include close tracking regardless of bias point, from 50 μ a to 500 μ a, low leakage of 100 pa and high gain of 1,000 μ mhos. Applications include balanced modulators and mixers, analog switching, and r-f applications up to 30 Mhz. National Semiconductor Corp., San Ysidro Way, Santa Clara, Calif. [437]

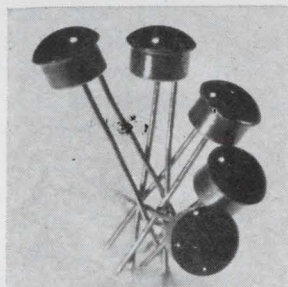

Low-cost, npn planar silicon phototransistors TIL-63, 64, 65, 66 and 67 are designed for applications such as character recognition, tape and card reading, velocity indication and decoding. Light current sensitivity ranges are 0.4 ma min., 0.4 to 1.6 ma, 1 to 4 ma, 2.5 to 10 ma, and 6 ma min., respectively. Texas Instruments Inc., P.O. Box 5012, Dallas 75222 [438]

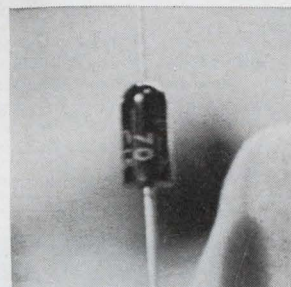

Plastic encapsulated zener diode BZX70 is a 2.5-w device. It measures approximately $\frac{1}{2}$ x $\frac{1}{4}$ in. with leads of just under 1 in., has a voltage range of 7.5 to 75 v. Surge rating is 100 w. As an aid to designers, the type number is clearly imprinted on the side. The devices are useful in communication and measuring equipment. Mullard Inc., 100 Finn Court, Farmingdale, N.Y. [439]

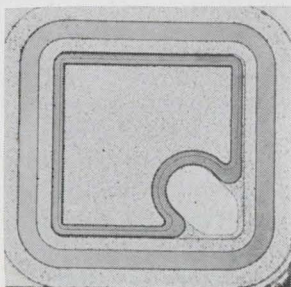

Low cost silicon controlled rectifiers are offered with forward and reverse voltage ratings from 30 to 400 v in an epoxy TO-106 package. Operation is guaranteed at junction temperatures of -65° to $+125^{\circ}$ C. Gate sensitivity is typically 10 μ a; on-state voltage drop, 1 v at 200 ma. Prices (1-99) range from 77 cents to \$2. Fairchild Semiconductor, Mountain View, Calif. [440]

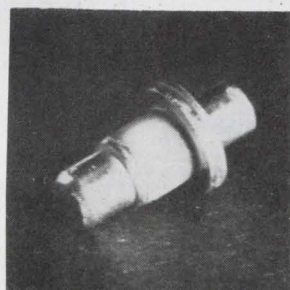

High power p-i-n diodes feature high dynamic Q switching in less than 300 nsec, high power handling capability, oxide and hard glass passivation, low C_T and high storage and operating temperature range. Units are recommended for use in r-f switching, limiting, phase shifting, duplexing and attenuating through Ku band. Microwave Associates Inc., Burlington, Mass. [441]

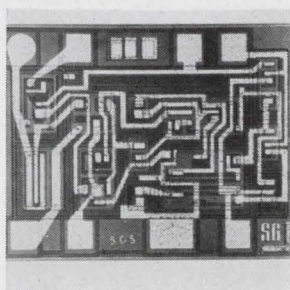

Voltage regulators SG105-205, and -305 feature output adjustable from 4.5 to 40 v, load regulation of better than 0.01%/ma and line regulation of better than 0.06%/v. With an input voltage of 50 v, they deliver loads up to 20 ma. The SG105 operates from -55° C to $+125^{\circ}$ C; the 205 and 305, from 0° to $+70^{\circ}$ C. Silicon General Inc., 7382 Bolsa Ave., Westminster, Calif. [442]

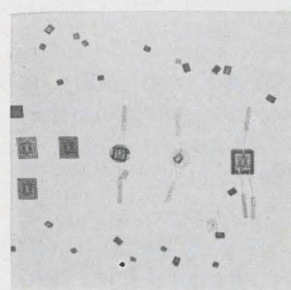

Silicon planar power transistors come in chip form for hybrid applications. Chips include the 2, 5, 10 and 20 amp families in npn, pnp and npn high voltage. In addition to their individual chip form, they may be mounted on a moly-tab or on moly pedestals with aluminum wire leads ultrasonically bonded to emitter and base contacts. Solitron Devices Inc., Riviera Beach, Fla. [443]

MICO

Pneumatic Controlled Drill Press

MANUAL CONTROLLED
MODELS ALSO
AVAILABLE

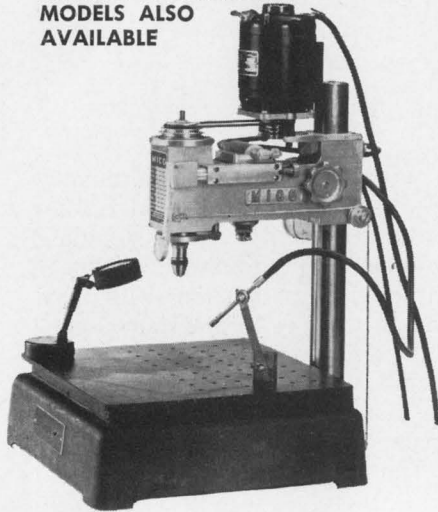

FEATURES OF PRECISION DRILL PRESS

Sensitive	Quick Spindle Response
Accurate	Only 50-75 lb. Air
Wide Range	Needed
Keyless Chuck	7500 to 10,000 r.p.m.
Dual Air Controls	Motor
Sturdy	Air-Mist System
Easily Adjusted	Available

Send for Illustrated Catalogs.

MICO INSTRUMENT CO.

77 Trowbridge St. Cambridge, Mass. 02138

Circle 214 on reader service card

SAN-E

MSP-4 full four track stereo
R/P head for auto-reverse
cassette system

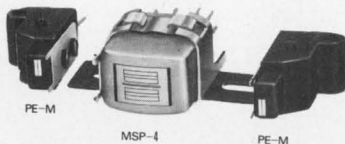

MSP-4 1/4 track full 4 heads R/P
head for phillips cassette tape
PE-M AC bias eraser for MSP-4
head

Other product
8 track (MS-8) stereo head
for home & car stereo

* write immediately
for further details

SAN-E DENKI COMPANY, LIMITED.

110-1 Minami-Kawahori-cho, Tennoji-ku,
Osaka, Japan
phones: 779-1591
cable: SANMAGNETICS

... high output impedance of OTA makes it useful as an active filter ...

transconductance amplifiers (OTA) on a single chip. Each can be independently biased, and each consumes as little as 100 microwatts of power.

RCA's design employs both pnp and npn transistors on the same silicon chip to eliminate the need for high-value resistors. The IC can therefore operate over current ranges spanning several decades, and is relatively easy to manufacture. The pnp transistors are lateral devices. Their current gains are well matched and largely independent of temperature. Although the output impedance of these devices tends to be low, this shortcoming is corrected by the circuit design.

A unity-power-gain application illustrates the flexibility of the CA3060. With bias adjusted to give a power consumption of 12 milliwatts, the slew rate is 8 volts per microsecond. With power set at 120 microwatts, slew rate becomes 0.1 volt per microsecond. Thus, the user can tailor the amplifier's performance; he doesn't have to buy many specialized op amps.

Representative of the nonlinear applications of the CA3060 is its use as an active filter. It's particularly suited to such applications because of its high output impedance. Two of the amplifiers in the CA3060 can be connected as a gyrator, for instance, and the high output impedance will provide the required 90° phase shift.

When the CA3060 is connected as a gyrator it forms a synthetic inductor that behaves just like a real one. Connecting it to a capacitor, for example, forms a parallel-resonant circuit that can be made to ring by applying a pulse signal. In addition, the variable transconductance feature of the amplifier can be used to vary the value of synthetic inductance. In fact, the term gyration resistance, which is often used to describe gyrator circuits, is essentially the reciprocal of the transconductance of the device.

Hermetically sealed in a ceramic dual in-line package, the CA3060 costs \$5.95 in quantities of 1,000.

RCA Electronic Components, Harrison, N.J. 07029 [444]

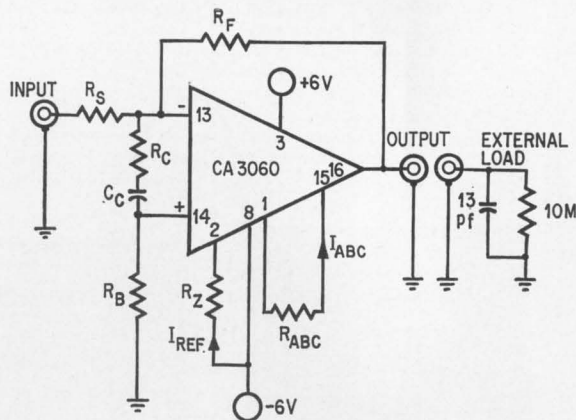

Variable. The CA3060 operational transconductance amplifier is shown connected as a unity-gain inverting amplifier. By varying bias current I_{ABC} , the slew rate and other characteristics of the circuit can be adjusted as shown in the table.

TYPICAL SLEW RATE TEST CIRCUIT PARAMETERS								
I_{ABC}	SLEW RATE	R_Z	R_{ABC}	R_S	R_F	R_B	R_C	C_C
μa	$V/\mu sec$	OHMS						μf
100	8	56k	62k	100k	100k	51k	100	0.02
10	1	56k	620k	1M	1M	510k	1k	0.005
1	0.1	56k	6.2M	10M	10M	5.1M	∞	0

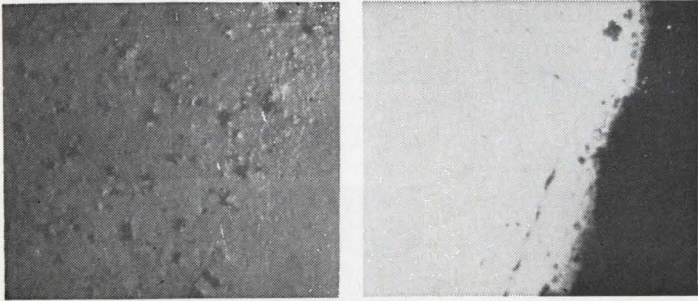

Two revealing views of a Playboy bunny.

We had to pull a switch to get them.

You're looking at two views of the interface between the white enamel of the bunny on a Playboy Club ashtray, and the black enamel background of the tray itself (magnified 70x).

The pictures were shot only seconds apart, through an Olympus Model N microscope—the only microscope that could have done it. Both show exactly the same field, but neither, alone, tells the whole story.

The photo on the left, taken by bright-field illumination, clearly shows the surface textures and irregularities of both the black and white enamel. But not which is which, because glare has washed out the color differences.

To make the photo on the right, we pulled a switch—the switch that converts the Model N instantly to dark-field incident illumination. Now the color differences are visible—as amorphous or crystalline inclusions or certain other irregularities would be, had there been any in our sample.

The Model N adapts easily to polarized and trans-illuminated observations, too; and its modular design accommodates a complete line of interchangeable accessory heads, eyepieces and camera equipment.

The Model N's Neopak bright-field/dark-field illuminator and objectives are also available in the Model NJ focusing head, for universal stand or custom mounting.

Like all Olympus microscopes, the N and NJ cost rather less than you'd expect. Send for our catalog of upright and inverted metallurgical microscopes. You won't find any other bunnies there, but we think you'll find it pretty revealing anyway.

This is what the bunny looks like when it isn't under the microscope.



© H. M. H. PUBLISHING CO.



OLYMPUS CORPORATION OF AMERICA
PRECISION INSTRUMENT DIVISION / DEPT. E
2 Nevada Drive, New Hyde Park, N.Y. 11040

Send information on The Olympus Model N, The Model NJ, bright-field microscopes, inverted microscopes. My applications include:

Name _____

Title _____

Organization _____

Address _____

City _____

State _____

Zip _____

"50 years of precision in microscopy"

Olympus Model N

Bright-field/dark-field metallurgical microscope

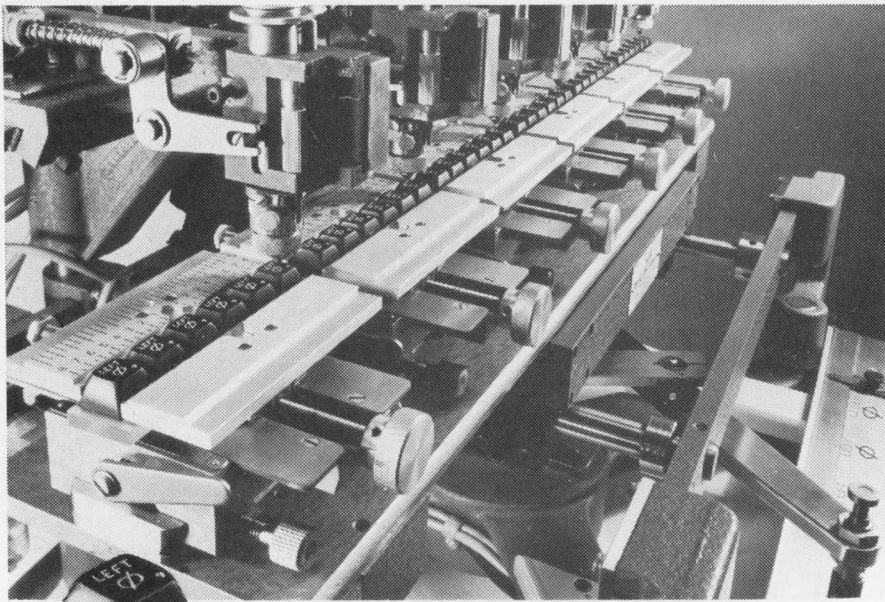

6 will get you 36

Now, new 6-spindle New Hermes engraves up to 36 machine keys with one set-up.

Any unskilled worker simply guides the pantographic tracer on this pneumatically-operated engraving

machine. Each spindle has an automatic depth-regulator, guaranteeing uniform depth and width of engraving over the complete contour of the key.

Write for detailed brochure No. 197.

new hermes engraving machine corp. 

20 Cooper Square, New York, N. Y. 10003

Chicago, Atlanta, Los Angeles, Dallas, Montreal, Toronto, Mexico City

See us at IEEE Show, Booth IB12 at the Coliseum

Circle 215 on reader service card

STATE-OF-THE-ART in electrical convenience

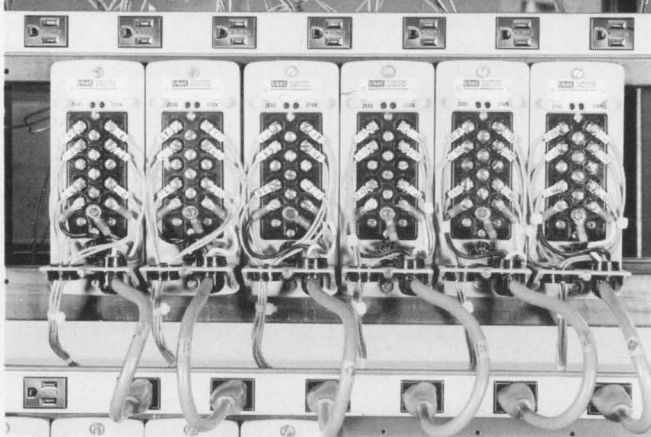

Look at the outlets! Here's proven, simplified power wiring for complex instrumentation behind or inside cabinets, panels, consoles. Easy-to-mount Plugmold 2000 Multioutlet Systems — the last word in compact, plug-in convenience.

Wiremold® and Plugmold® systems help put "tomorrow" in today's wiring for makers, users, and testers of electronic equipment. Write for helpful, problem-solving literature.



THE WIREMOLD COMPANY / HARTFORD, CONNECTICUT 06110

New materials

Ceramic coating insulates devices

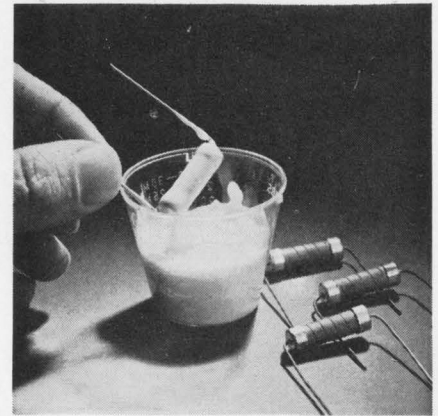

Ceramic dip coating called Cerama-Dip 538 is for use in insulation of components at temperatures up to 3,200°F. It is available in a paste form with a liquid thinner used to produce a soup-like thixotropic consistency. The material can then be brushed on, or the component dipped in the mixture. The hardened coating shows a dielectric strength of 150 v per mil at room temperature, dielectric constant of 4, volume resistivity of 10^9 ohm-cm at room temperature. Aremco Products Inc., P.O. Box 145, Briarcliff Manor, N.Y. 10510 [401]

Butyl rubber conformal coating, designated BCC, features low molecular weight, but moisture vapor transmission resistance is 200 to 300 times greater than epoxies, and 500 to 800 times greater than silicones. It offers a 1-to-1 mix ratio and 4-hour pot life. The coating is readily applied by brush, spray or dip. Nureco Inc., 335 Valley St., Providence, R.I. 02908 [402]

Precision ceramic substrates for the IC industry are offered in finishes of from 25 μ in. to 0.3 μ in., with flatness of 0.0004 in./in. or better. Thickness on these parts can be held to \pm 0.0003 in. or closer, and the parallelism can be 0.0003 in. or lower. The Van Keuren Co., 176 Waltham St., Watertown, Mass. 02172 [403]

Alkali-soluble wet acid resist KC7000 is designed to give the circuit board printer a speedy and effective wet etch. A freshly printed circuit board can be immediately exposed to hot $FeCl_3$ solution without being allowed to dry. It can be easily removed with 6 to 10% sodium hydroxide or 10 to 15% of sodium carbonate solution. At these concentrations, the resist film will be loosened but remain on the board until sprayed with water; keeping the caustic tank relatively free of sludge. K.C. Coatings Inc., 500 Railroad Ave., North Kansas City, Mo. 64116 [404]

New Books

All about GaAs

Gallium Arsenide Lasers
C.H. Gooch, editor
Wiley-Interscience, Lond,
333 pp., \$14.50

Recently developed techniques in semiconductor construction are yielding devices with increased efficiency and output at room temperature. Not since their appearance in late 1962, has interest in gallium arsenide lasers been so high. With this renewed interest has come a flood of new books dealing with both the construction of these devices and their applications. This book, one of the best, is written by a group of semiconductor specialists working in Britain; it is edited by C.H. Gooch, a pioneer in electron physics, who also wrote one of the chapters.

Although each chapter is the work of a different author, the book is not simply a collection of papers: its structure progresses logically. Starting with the general theory of p-n junctions, it quickly focuses on the GaAs laser, treating the preparation and properties of GaAs, the technology involved in its construction into laser junctions, and the applications now available using these devices.

Each subject is treated in the depth that only a specialist can provide. The discussion by Gooch on the properties of GaAs p-n junction lasers provides an example. Starting with the basic junction configuration, he discusses the methods of cleaving and polishing to obtain the desired directions of radiation, as well as typical power requirements for several configurations.

Threshold properties are evaluated in terms of laser configurations: the relationship between threshold current density is developed and the individual loss terms are analyzed. Included in this chapter is a discussion of the effects of temperature on optical loss—probably one of the most useful sections of the book. Gooch includes both diffused and epitaxial junctions, showing why epitaxial junctions offer better performance at room temperature. The

quantum efficiency—the measure of electron-photon conversion—is analyzed for room temperature operation, and the factors for low efficiency due to losses in the cavities are treated in detail. This discussion then is enlarged to deal with the low average power available from these devices at room temperature. Finally, speculations are made on improvements in laser construction that can overcome these limitations.

The last half of the book is devoted to applications. Treated here are the essential features of GaAs lasers—small size and high efficiency—which make them especially good amplifiers and switching devices. The author of this chapter, R.F. Broom, of the University of Berne, discusses the theory of amplification and gives several configurations. He includes a novel array configuration used to increase the gain, in which several individual amplifiers are coupled to a single GaAs laser. Details of the coupler and isolator also are discussed.

The last chapter treats other areas of applications. These include information on beam brightness and spectrum content, different laser pulse generators, and data giving the typical power available for both pulsed and c-w operations. Since c-w applications require cooling, many different methods are treated. Included are thermoelectric cooling, mechanical refrigerators, direct cooling by liquids and solids, and the Joule-Thomson expansion coolers which have proved so effective for cooling GaAs lasers.

Also, in this chapter is a discussion of laser optics, detectors, and laser systems that can be used in atmospheric transmission.

Recently Published

Automatic Data Processing, System/360 Edition, F.P. Brooks Jr., and K.E. Iverson, John Wiley & Sons, \$14.50

For use by college students in a two-semester second course in computer science, the volume covers fundamental data processing as applied to the IBM 360 computer. Simple and more advanced exercises are featured.

"must reading"

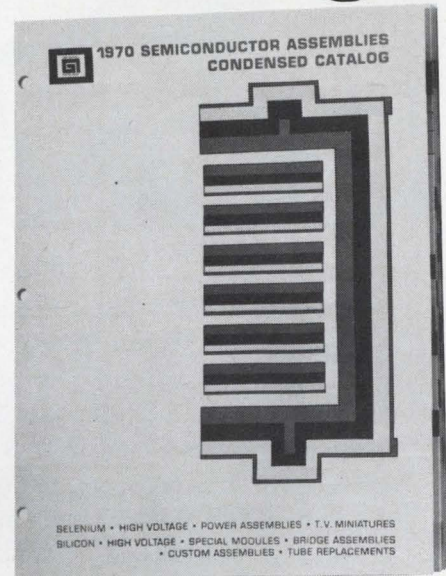

free

Silicon or Selenium? You'll find the answer in this 1970 Condensed Catalog just published by General Instrument's Semiconductor Assembly Division. The industry's most up-to-date catalog of its kind covers GI's line of BOTH Silicon and Selenium assemblies in half-wave, bridge, multiplier and other configurations in a full range of currents and voltages. (All silicon devices are V(BR) 100% tested.) Also shown, for a wide variety of applications, are custom assemblies incorporating exclusive TC^{2*}.

It's must reading and reference for everyone concerned with rectifier applications. Order your free copy today. Write General Instrument Corporation, Semiconductor Assembly Division, 65 Gouverneur Street, Newark, New Jersey 07104.

*General Instrument Trademark:
Thermally Conductive Connectors



GENERAL INSTRUMENT CORPORATION
65 GOUVERNEUR STREET,
NEWARK, NEW JERSEY



ASK

A Micro

COMPET

Now ask a Micro Compet. At last you can. Our extensive development of ELSI (Extra Large Scale Integration) specifically for use in electronic calculators (Electronics 11/11/'68) has paid off. The result you can see. Micro Compet QT-8D.

It's hand-sized and weighs just 3 lbs. Silently performs $+ - \times \div$ and mixed calculations up to 8 digits. Answer response is fast and clear on a new green read out.

We think Micro Compet is a design breakthrough. It's compact, stable and easy to use. It should be good. We made the first solid-state electronic calculators and today make more than anybody else.

Ask to see Micro Compet QT-8D soon.

IEEE Show booth No. 4G-16,18

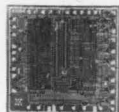

A single 1/8" square ELSI does the work of 1875 electronic components. With 4 ELSIs Micro Compet ensures maximum performance in ultra-miniature dimensions.

Magnified ELSI
by 25 times



Model
QT-8D

► Hayakawa Electric Co., Ltd. changed its name to Sharp Corporation on January 1, 1970.

SHARP
SHARP CORPORATION Osaka, Japan

U.S. Subsidiary: SHARP ELECTRONICS CORP. 178 Commerce Road Carlstadt, New Jersey

Technical Abstracts

Multiple savings

High-voltage multipliers in tv receivers
M.E. Buechel
Semiconductor division, Varo Inc.,
Garland, Tex.

High voltage multipliers—rectifier systems consisting of diodes and capacitors arranged to yield a d-c output voltage higher than the peak input—are becoming popular in cathode-ray tube circuits because of their efficient energy conversion and cost savings. They also eliminate the hazard introduced by rectifier X-ray radiation in color television receivers. With this hazard out of the way, drastically reduced electrostatic pulse fields and new fireproof and fire-retardant flyback construction techniques can be applied to reduce the metal high-voltage housing to the size of an ordinary bracket.

These multipliers are tapped by simple bleeder networks to provide a focus voltage on present 23-inch color crt's. This eliminates the separate focus rectifier, the voltage bucking coil for focus adjustment, and associated bulky components. Instead, only two high-value resistors and a focus potentiometer are required.

Also eliminated are the rectifier tube, tube socket, cup, X-ray shield for cup, filament lead, coil hardware, and other hardware. The flyback transformer's size is drastically reduced, yielding a reduction in the size and weight of the required transformer coil. It may also be possible to reduce all the impregnating and encapsulating costs.

The core is reduced in length and cross-sectional area. Since the flyback secondary voltage and overall diameter are reduced, the core lengths may be shortened. The freedom from the circulating currents necessary with third-harmonic tuning reduces the flux field, permitting cores with a small cross-sectional area. Reductions allow small and simple core mountings.

Eliminating the third-harmonic circulating currents reduces the system's peak currents and permits use of a sweep device and damper with reduced ratings and longer life expectancy.

Presented at NEC, Dec. 8-10, 1969.

Advances in your field you should be aware of. (And can be—very easily.*)



384 pages
\$22.50

ELECTRONIC FLASH, STROBE

By Harold E. Edgerton. From the man who developed the modern stroboscope—a full explanation of both theoretical and practical aspects of electronic flash systems today, including descriptions of typical systems currently in use. Twelve experiments help you apply the strobe system to best effect in your work, research, or for your hobby.



192 pages
\$10.00

The NEW ELECTRONICS

By Bruce Shore. If you find it difficult keeping up with solid-state electronics today because of complex theory and math, here's a thoroughly *non-technical* guide you'll readily appreciate. Takes you into the laboratories where great discoveries were and are being made, and shows you exactly what is happening. Scores of fascinating illustrations.

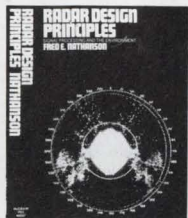

554 pages
\$22.50

RADAR DESIGN PRINCIPLES

By Fred E. Nathanson. Here's the first comprehensive treatment of radar waveform and processing problems, with special emphasis on environmental factors. Summarizes a wealth of field-tested design, performance, and application data on how to cope with adverse environments in detecting and processing radar signals.

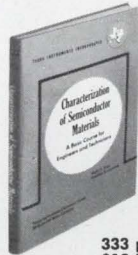

333 pages
\$18.50

CHARACTERIZATION of SEMICONDUCTOR MATERIALS

By P. F. Kane and G. F. Larrabee. Brings together, in a single reference, all the applications of physical and chemical characterization methods to semiconductors. Emphasis is where you want it: on solving *problems* involving semiconductor characterization.

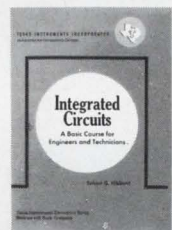

172 pages
\$9.95

INTEGRATED CIRCUITS

By R. G. Hibberd. If you'd like a better understanding of integrated circuits to evaluate their potential application in your own particular specialty, this is the authoritative guide for you. Emphasis is on overall function and application rather than the details of internal circuitry. Illustrated to aid your understanding.



205 pages
\$11.00

COMPUTERS for ENGINEERS

By Bartow Hodge. Explains in practical terms how computers work and what they can do for you. From characteristics of digital computers and the nature of computer logic right on through a comprehensive treatment of current hardware and software. The book answers the questions engineers most want to know.

HANDBOOK of PROBABILITY and STATISTICS with Tables

Second Edition. By R. S. Burlington and D. C. May, Jr. A timely new edition of the classic, pocket-size key to probability and statistics. Tuned throughout to today's needs in engineering, R&D, testing and evaluation work, it brings today's most vital theories and techniques within easy, practical reach. 416 pages, \$9.95

PROCEEDINGS of the FIRST NATIONAL CONFERENCE on ELECTRONICS in MEDICINE

Electronics Management Center. Twenty-seven authorities evaluate accomplishments of medical electronics, pinpointing problems and suggesting new ways to extend the physicians' capacity for serving future needs. First cooperative effort of its kind between electronic and medical fields. 211 pages, \$14.50

SYNTHESIS of RC ACTIVE FILTER NETWORKS

By S. S. Haykim. Presents a detailed study of the circuit properties of negative impedance converters, amplifiers and gyrators, and of their uses in the synthesis of inductorless filters. Features detailed synthesis procedures for low-pass and high-pass and band-pass filters, with numerous illustrative examples. 180 pages, \$12.00

ELECTRONS in METALS and SEMICONDUCTORS

By Denis Grieg. Here's the easy way of gaining a thorough understanding of how solid-state devices work. Explains necessary physics in simplest possible way (without requiring physics background), it covers wave mechanics, quantum numbers, Fermi-Dirac statistics, and other advanced concepts. 176 pages, \$13.50

* just return this coupon

McGraw-Hill Book Co., Dept. 23-E-327, 330 W 42 St., N.Y. 10036

Send me the book(s) checked below for 10 days on approval. In ten days I will remit for book(s) I keep, plus a few cents for delivery costs, and return others postpaid.

- | | |
|--|---|
| <input type="checkbox"/> Edgerton: Electronic Flash, Strobe, \$22.50 | <input type="checkbox"/> Burlington & May: Handbook of Probability and Statistics with Tables, \$9.95 |
| <input type="checkbox"/> Shore: The New Electronics, \$10.00 | <input type="checkbox"/> Haykim: Synthesis of RC Active Filter Networks, \$12.00 |
| <input type="checkbox"/> Nathanson: Radar Design Principles, \$22.50 | <input type="checkbox"/> Electronics Management Center: Electronics in Medicine, \$14.50 |
| <input type="checkbox"/> Kane & Larrabee: Characterization of Semiconductor Materials, \$18.50 | <input type="checkbox"/> Grieg: Electrons in Metals, \$13.50 |
| <input type="checkbox"/> Hibberd: Integrated Circuits, \$9.95 | |
| <input type="checkbox"/> Hodge: Computers for Engineers, \$11.00 | |

Name (print) _____

Address _____

City _____

State _____

Zip _____

This offer good in U.S. and Canada only.

23-E-327

Send your electrical contact requirements to—

NEY

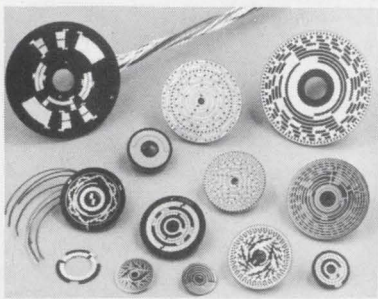

**NEYETCH
COMMUTATORS
AND SLIP RINGS**

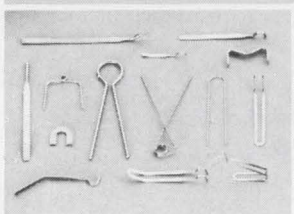

WIRE FORMS

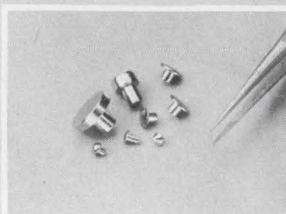

HEADED CONTACTS

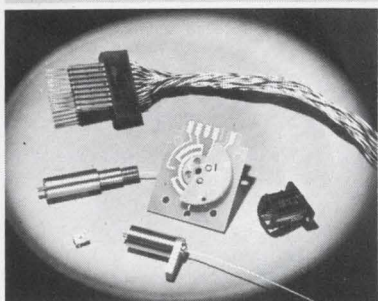

**ASSEMBLED
COMPONENTS**

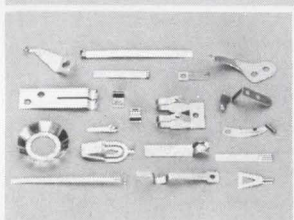

**STAMPED AND
FORMED CONTACTS**

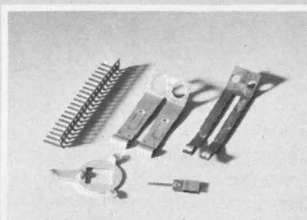

**WELDED AND
STAKED ASSEMBLIES**

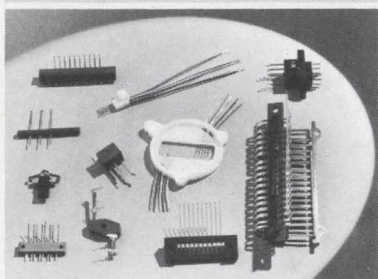

**MOLDED
CONTACT
ASSEMBLIES**

PALINEY®, NEYORO® ALLOYS

62 PAGE CATALOG ON REQUEST

THE J. M. NEY COMPANY
Maplewood Ave., Bloomfield, Conn.
TEL. HARTFORD 242-2281 (area 203)

NEY

**YOU SET THE STOPS
TO SUIT YOUR
CIRCUIT**

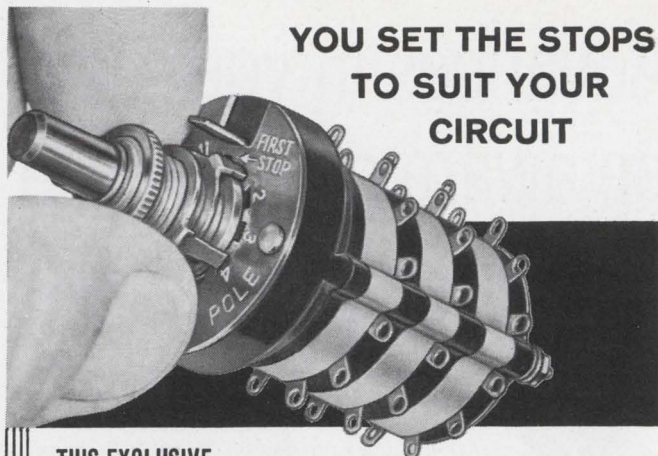

**THIS EXCLUSIVE
GRAYHILL ADJUSTABLE STOP FEATURE**
simplifies switch selection for prototype
and small production run.

- 1 to 4 Poles Per Deck
- 2 to 12 Positions Per Pole
- 1 to 12 Decks
- Shorting Or Non-shorting Contacts
- 30°, 36°, 45° or 60° Angle Of Throw
- Concentric Shaft Switch And Potentiometer Styles Available
- Explosion Proof Design

For your Grayhill Engineering Catalog
offering complete technical data—contact



523 Hillgrove Avenue
LaGrange, Illinois 60525
Area Code 312, Phone 354-1040

... the Difference Between Excellent and Adequate

Circle 218 on reader service card

± 0.000V ~ 1000V · DC
0.000Ω ~ 30.00MΩ



**MODEL 156A
DIGITAL VOLT
OHM METER**

The dynamic range is wide, and measurement can be counted up to "3000" in four decimal digits without switching the range. When a voltage higher than "3000" preset is applied to the input, a lamp lights to indicate it. Compact and lightweight, the Model 156A requires a minimum bench space. Operating procedure

is very simple. The measuring speed is as high as 10 samplings/sec. Polarity switching is automatic. Because of the memory circuit, indication has little flicker. The measuring accuracy is as high as ±(0.1% + 1 digit) of the indicated value. The input resistance is 10 megohms for all measuring ranges. The input terminals are floated from the case.



kikusui
KIKUSUI ELECTRONICS CORP.

3-1175, SHINMARUKO-HIGASHI, KAWASAKI-CITY, KANAGAWA-PREF., JAPAN
TELEPHONE: (044) 41-0111, CABLE ADDRESS: "KIKUSUIDE" KAWASAKI

New Literature

Signal conditioning. Brush Instruments Division, Gould Inc., 3631 Perkins Ave., Cleveland 44114, has issued a booklet that explains the six basic types of signal sources, conventional amplifier input configurations, and proper grounding techniques.

Circle 446 on reader service card.

Tabular filters. Lark Engineering Co., 3801 N. Broadway, Indianapolis 46205, announces a 12-page technical bulletin describing its lowpass and bandpass coaxial filters and high power, low loss impedance transformers. [447]

Silicon carbide rectifiers. Westinghouse Astronuclear Laboratory, P.O. Box 10864, Pittsburgh, Pa. 15236. Silicon carbide rectifiers operating at double the temperature and ten times the radiation that disable conventional silicon rectifiers are covered in booklet MP-069. [448]

Low-voltage readouts. Dialight Corp., 60 Stewart Ave., Brooklyn, N.Y. 11237. Catalog sheet L-191 provides data, dimensional drawings and ordering information on incandescent segmented readout modules for 5 v, 6 v and 14-16 v supply voltages. [449]

Connector selection. Mepco Inc., Columbia Rd., Morristown, N.J. 07960, has published a comprehensive selector chart covering its p-c edge connectors, interconnectors, combination connectors and high-density connectors. [450]

Diode designs. Fairchild Semiconductor, Box 1058, Mountain View, Calif. 94040. A 24-page brochure outlines opportunities for improving discrete diode designs by multifunctional diode assemblies and monolithic arrays. [451]

Switch catalog. McGill Mfg. Co., Valparaiso, Ind. 46383, has released a catalog on its snap-action, rocker-actuated, paddle, toggle and push-button switches. [452]

Power controls. Ohmite Mfg. Co., 3601 Howard St., Skokie, Ill. 60076. A complete line of solid state power controls for 120- and 240-v a-c or d-c motors and heaters is described in bulletin 810D. [453]

General-purpose filters. Hopkins Engineering Co., 12900 Foothill Blvd., San Fernando, Calif. 91342. A 20-page catalog shows a line of feed-through, L-section, T-section, pi-section, and double-L section filters designed to meet or exceed MIL-F-15733E specs. [454]

Expandable core memory. Cambridge Memories Inc., 285 Newtonville Ave., Newtonville, Mass. 02160, offers a brochure describing a field-expandable, 18-bit core memory system. [455]

Transistorized chopper. Solid State Electronics Corp., 15321 Rayen St., Sepulveda, Calif. 91343, offers a two-page data sheet describing the model 65 transistorized plug-in chopper with transformer-coupled isolating drive network. [456]

Transient waveform reproducer. Phys-Tech Inc., 645 Davisville Rd., Willow Grove, Pa. 19090. A new device for reproducing transient waveforms for use in computer analysis is described in bulletin 691. [457]

Power supplies. Powertec Division of Airtronics Inc., 9168 DeSoto Ave., Chatsworth, Calif. 91311. The 1970 catalog is a 12-page selection guide for all types of modular power supplies of both commercial and off-the-shelf militarized types. [458]

Right-angle cable plug. Seaelectro Corp., 225 Hoyt St., Mamaroneck, N.Y. 10543, has available a bulletin on the 50-628-3141-31 crimp-type right-angle plug designed for use with miniature coaxial cables. [459]

Miniature flexible cables. Caltron Industries, 2015 Second St., Berkeley, Calif. 94710. A short-form catalog covers 26 different miniature flexible cables for use in instrumentation and transducers. [460]

P-c design. High Altitude Products Co., P.O. Box 1205, Boulder, Colo. 80302. A booklet entitled "Printed Circuit Design and Documentation; A Straight Forward System" is a short course in printed circuit design. [461]

Spiral-cut cable wrap. L. Frank Markel & Sons Inc., School Lane, Norristown, Pa. 19404, has available technical literature on its Flexite spiral-cut cable wrap that is used to harness, insulate, and protect a broad range of wires, tubing lines, cables or bundles of wire or cables. [462]

Semiconductor packaging. Circa Tran Inc., P.O. Box 832, Wheaton, Ill. 60187. A new service for packaging transistors and diode chips is explained in single-page bulletin No. 1. [463]

Digital signal processing. Computer Signal Processors Inc., 209 Middlesex Turnpike, Burlington, Mass. 01803, offers a brochure on digital signal processing system CSS-3. [464]

Noise figures. Princeton Applied Research Corp., P.O. Box 565, Princeton, N.J. 08540. A four-page brochure explains the value of noise figures as a tool in specifying the proper amplifier for a given low-level signal source. [465]

Test Power Transistors



FAST · ACCURATE · AUTOMATIC

The Lorlin Automatic Transistor Tester Model TB is programmable over a range of 0.1 nanoamps to 10 amps and 10 mV to 600 V. All types of transistors from small signal to high power can be tested for breakdown voltages, leakage, gain and saturation voltages with 1% accuracy.

A complete test sequence can be programmed by the operator in minutes. Since a standard test takes just 16 milliseconds, high daily thruput is possible.

Models are available with up to 24 test positions and 18 sorting classifications. Remote test stations with the same range and accuracy are available to permit several operators to share one tester. All Lorlin testers will interface with automatic probing, handling and classifying equipment.

Lorlin testers are designed for maximum reliability, ease of service, convenience of programming, and simplicity of operation. Their speed, accuracy and reasonable price provide users a substantial return on their capital investment. Write or call for more information and a demonstration in your plant.

SEE THE MODEL TB AT BOOTH 2K37 IEEE
LORLIN
industries inc.

Precision Road, Danbury, Connecticut 06810
Tel: 203-744-0096

For Literature circle 510
For Demonstration circle 511

NEW

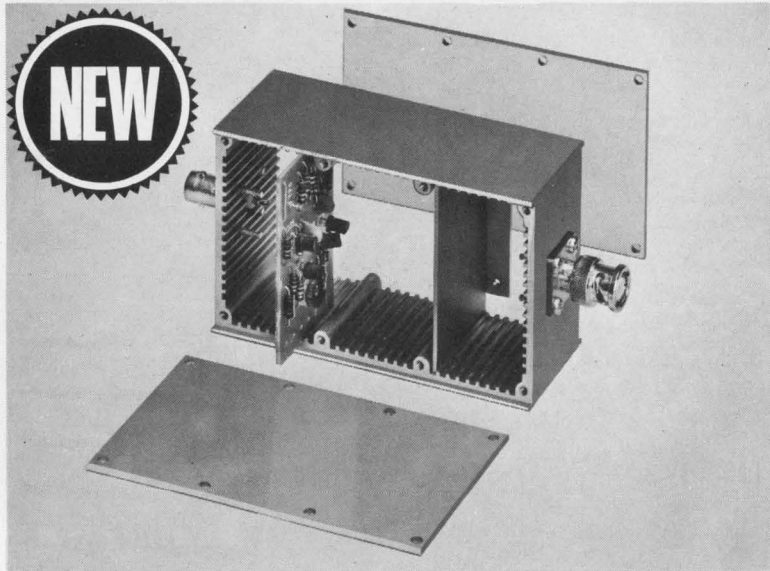

SHIELDED BOXES with CARD GUIDES

Rugged die-cast aluminum boxes, slotted to accept $\frac{1}{8}$ " circuit boards and shielding dividers. Excellent for packaging electronic circuitry. Boxes have removable top and bottom covers. Useable inside space: 4"x2"x1 $\frac{1}{2}$ ". Several models with various connectors.

Write for 1969 Catalog.



POMONA ELECTRONICS CO., INC.
1500 E. Ninth Street, Pomona, California 91766

Circle 222 on reader service card

Available in production quantities now!

10 AMP & 25 AMP IBR®

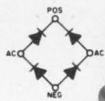

Varo Integrated Bridge Rectifiers offer single-phase full-wave rectification in an electrically insulated case.

Controlled avalanche characteristic permits selection of decreased PRV safety factor without greatly reduced transient voltage vulnerability.

The IBR® is ideal for use where space, current and cost requirements disallow use of discrete semiconductor devices.

ELECTRICAL CHARACTERISTICS at $T_C = 25^\circ\text{C}$ (Unless Otherwise Specified)	SYMBOL	200V	400V	600V	UNIT
Minimum Avalanche Voltage	$V_{(BR)}$	250	450	650	VOLT
Maximum Avalanche Voltage	$V_{(BR)}$	700	900	1100	VOLT
RMS Reverse Voltage	$V_{R(RMS)}$	140	280	400	VOLT
Average Rectified Output Current at $T_C = 100^\circ\text{C}$ (Fig. 2)	I	10 or 25			AMP
Nonrepetitive Peak Surge Current (Fig. 3)	I_{FM} (surge)	100/250			AMP/LEG
Max. Surge Current, 1 sec. at 60Hz and $T_C = 100^\circ\text{C}$ (Nonrep.)	$I_{F(RMS)}$	30/50			AMP
Power Dissipation in $V_{(BR)}$ Region for 100 μ sec., Square Wave (Fig. 4)	P_{RM}	600/1500			WATT
Insulation Strength, Circuit-to-Case		2000 (MIN)			VDC



SEMICONDUCTOR DIVISION, 1000 N. SHILOH ROAD, GARLAND, TEXAS 75040 (214) 272-4551

New Literature

Soldering equipment. Ideal Industries Inc., 5180 Becker Place, Sycamore, Ill. 60178. Soldering equipment, designed to handle the miniature and subminiature job, or the large soldering and brazing project, is completely described in bulletin 7. [466]

Capacitor catalog. Vitramon Inc., Box 544, Bridgeport, Conn. 06601. A six-page condensed catalog features eight porcelain capacitor styles, six ceramic styles, and the full line of VeeJam chip capacitors. [467]

Stacking connector. Hugh H. Eby Co., 4701 Germantown Ave., Philadelphia 19144, has published a technical bulletin on a stacking connector that completely eliminates intermittent connections in interconnecting p-c boards. [468]

Video amplifiers. Aertech Industries, 825 Stewart Dr., Sunnyvale, Calif. 94086. Interface considerations between r-f detectors and post-detection video amplifiers are discussed in a new low-noise video amplifier data sheet. [469]

Thin-film IC's. Micro Networks Corp., 5 Barbara Lane, Worcester, Mass. 01604. A six-page brochure discusses the processing philosophy and materials characteristics involved in the manufacture of precision thin-film hybrid IC's. [470]

Toroidal winding machines. Arnold Magnetics Corp., 11264 Playa Court, Culver City, Calif. 90230, has available a four-page catalog describing the features of its toroidal winding machines. [471]

Vhf marine antenna. Phelps Dodge Communications Co., Route 79, Marlboro, N.J. 07746, has published a catalog sheet describing a vhf marine antenna available in the 150-174 Mhz frequency range and offering 3 db omnidirectional gain. [472]

Silicon controlled rectifiers. National Electronics Inc., Geneva, Ill. 60134. Quick reference catalog SB-57 lists a complete line of SCR's with condensed technical information. [473]

Core memory system. Dataram Corp., Route 206, Princeton, N.J. 08540. A bulletin on the PDM-17 point designed memory system contains data and features of interest to designers and OEM's in the fields of crt displays, magnetic tape buffering, optical character recognition, and numerical control systems. [474]

Switch lights. Korry Mfg. Co., 223 8th Ave. North, Seattle, Wash. 98109. A six-page short-form catalog describes 11 models of switch lights and indicators for applications in aircraft, computers and instruments. [475]

WANTED: ELECTRONICS MANUFACTURER

to help meet the needs
of a lucrative
Texas market

Excellent opportunity for growth-minded electronics manufacturer to locate in Texas and help meet the needs of the third fastest-growing state. Stable, productive labor. Incomparable tax advantages. Lowest living costs. For Texas Fact Book, write or call:

James H. Harwell, Executive Director
TEXAS INDUSTRIAL COMMISSION

Capitol Station Box JJ-E
Austin, Texas 78711
Telephone 512/475-4331

Circle 220 on reader service card

WE'LL GIVE YOU 100 SUBMINIATURE TOGGLE SWITCHES AND ONLY CHARGE YOU FOR ABOUT 92.

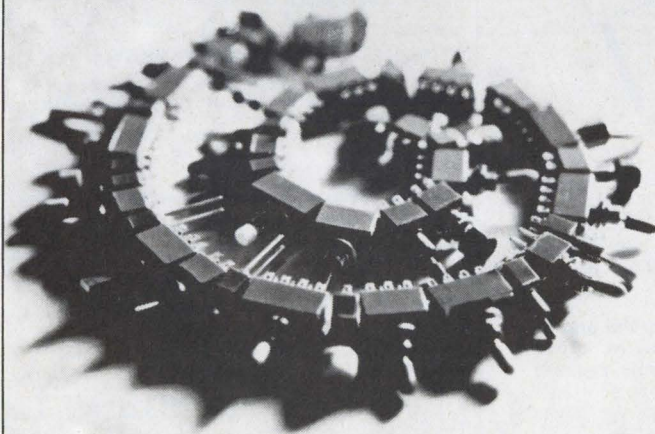

The price of all C&K toggle switches has just been reduced approximately 8%. Same C&K quality. Same Made-in-America label. Now at the lowest price ever. Inflation. Thy days are numbered.

C&K COMPONENTS, INC.

103 Morse Street, Watertown, Massachusetts 02172
Tel: (617) 926-0800

SEE US AT I.E.E.E. BOOTH NO. 4 E 20

Circle 221 on reader service card

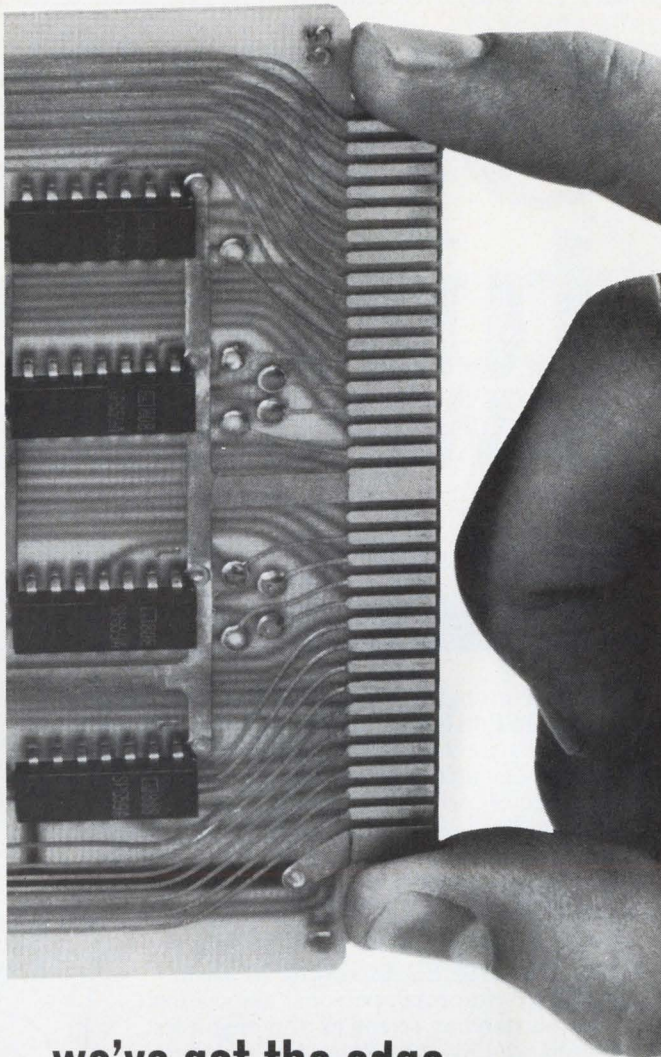

we've got the edge on our logic competition

And it starts with the 70 connection edge of all our logic assemblies. Our design brings more digital functions to the outside world, puts more functions on a card. And the trend toward more complex functions and large scale integration won't obsolete our design - in fact, we're helping make it possible.

Get an edge on your competition, choose from the industry's widest range of logic assemblies - DTL for moderate speeds, TTL for high frequencies, and MSI for low cost through better packaging.

In the Cambion line, you'll find all the logic cards you'd expect to need plus those one-of-a-kind required to complete your system without having to develop the card yourself. You'll also find all the necessary accessories, connectors, card drawers and files and power supplies. In fact, you can start your system design at any level and gain a competitive edge with Cambion logic assemblies and accessories. We've got a manual full of them we'll be glad to send you. Just send us your name. Do it today. Cambridge Thermionic Corporation, 445 Concord Avenue, Cambridge, Mass. 02138.

Standardize on

CAMBION®

The Guaranteed Logic Assemblies

Circle 199 on reader service card

199

Opportunities: at Westinghouse R&D

At the Westinghouse Research and Development Center in Pittsburgh, multiple discipline research programs are aimed at understanding basic science phenomena and applying the resulting knowledge to products, processes, materials and systems in such diverse areas as chemistry; communication, control and power electronics; ecology and systems; energy systems; materials and materials processing; oceanography; solid state devices; and solid state sciences.

DISTINGUISHED SCIENTIFIC COMMUNITY Informal, personal association with outstanding scientists and engineers is enhanced by our outstanding technical facilities. Innovational thinking; participation in seminars; and publication is highly encouraged.

STIMULATING LOCATION The R&D Center is situated in a campus-like setting; an appealing suburban locale; with excellent educational, cultural and recreational facilities only minutes away from beautiful residential areas.

■ Current Openings

ELECTRO-MECHANICAL

Development of electro-mechanical devices for new consumer products, automation machinery, electro-hydraulic and -pneumatic control systems, etc. Demonstrable inventiveness is necessary. BS, MS or PhD in Mechanical or Electrical Engineering.

SOLID STATE CIRCUIT DEVELOPMENT

Development of advanced digital and analog solid state circuitry for control systems, computers, instrumentation and information processing.

BIOENGINEERING

Design and develop new products for

application in biomedical research, diagnostic and therapeutic equipment, prosthetic devices and underwater life support. MS or PhD in Chemical, Electrical, or Mechanical Engineering.

If you are interested in the above, or have qualifications in other areas of R&D, send your resume in confidence to

Steve Lison
Professional Employment
Administrator
Research & Development Center
Westinghouse Electric Corporation
Beulah Road, Churchill Boro
Pittsburgh, Pa. 15235



An Equal
Opportunity Employer



EMPLOYMENT OPPORTUNITIES

We have been placing B.S., M.S. and Ph.D. **ELECTRONIC ENGINEERS** in fee paid positions throughout the U.S. since 1959. Send resume today or request confidential application. We are graduate engineers, working full time . . . for you.

ATOMIC PERSONNEL, INC.
Suite L, 1518 Walnut St., Phila., Pa. 19102
AN EMPLOYMENT AGENCY FOR ALL TECHNICAL FIELDS

CIRCLE 967 ON READER SERVICE CARD

ADDRESS BOX NO. REPLIES TO: Box No.
Classified Adv. Dept. of this publication.
Send to office nearest you.

NEW YORK, N. Y. 10036: P. O. Box 12

CHICAGO, Ill. 60611: 645 N. Michigan Ave.

SAN FRANCISCO, Cal. 94111: 255 California St.

POSITIONS VACANT

Wanted—Electrical or electronics engineer with five or more years experience needed to teach in the area of electronics technology. Applicant must have B.S. degree (M.S. preferred). Salary commensurate with qualifications. Excellent future. Send resume to: Dr. A. A. Paloumpis, Dean of Instruction, Illinois Central College, P.O. Box 2400, East Peoria, Illinois 61611.

Electrical-Electronic Engineers. Salaries \$10-\$25,000. We specialize in developing nationwide job search programs to fit your particular position objective and location flexibility. Project, Design, R&D, and management openings in all fields. Fees Company Paid. 85 affiliate offices to serve you. Send resume in confidence with present and desired salary, reason for desiring change and location flexibility to Leonard Personnel, 310 Empire Bldg., Pittsburgh, Pa. 15222.

CATALOGUE AVAILABLE

Radar Inventory—Catalog, No. 470 Radar Reference Guide contains listings of in-stock, available for immediate delivery radar systems, antenna systems, rf packages, indicators, pulse modulators, microwave tubes and components, test equipment, waveguide components and computers. 16 pp. Radio Research Instrument Co. 45 W. 45th. St., New York, N.Y. 10036.

BUSINESS OPPORTUNITY

Capital Contacts—Before you try Public or Private Placements to Underwriters, Investment Banking Houses, write for free helpful information to Confidential Consultant, 817 51st St., Brooklyn, N.Y.

Remember . . .

MAIL MOVES

THE COUNTRY

but . . .

ZIP CODE MOVES

THE MAIL

CIRCLE 966 ON READER SERVICE CARD

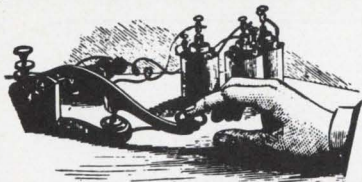

WE'VE COME A LONG WAY! HAVE YOU?



THE BUNKER-RAMO CORPORATION

a recognized world leader in On-Line Electronic Data Processing, is still actively seeking new and better ways to utilize CRT's and improve data display devices for all types of business applications. The very nature of our products and services is rapidly changing the faces of major industries in many vital markets—hotels, banks, airlines as well as the entire financial community.

As a result of our continuous expansion in these areas, the following positions are immediately available:

PRODUCT DEVELOPMENT ENGINEERS

Graduate engineers with heavy experience in development of solid state digital circuits, integrated circuits and devices. Responsibilities will be in linear as well as switching circuitry for CRT and other display media, communications, data processing and memory systems utilizing delay lines and magnetic components.

LOGIC DESIGN ENGINEERS

Development and production design. Ability to assist in specifications. Must be able to work alone on logical layouts, detailed logic design (using standard packages), and prototype testing. Knowledge digital communications, display techniques and storage media desired. BSEE with 3 years logic design experience.

SYSTEMS ENGINEERS/ANALYSTS

Define system requirements, equipment selection, evaluation of system configurations, specification of operational techniques, system solution and proposal preparation/presentation. Work with airlines, banks, hotels, brokerage and industrial firms, on systems application of man/machine I/O data communications and display devices. Degree and at least 4 years real-time on-line experience essential.

Our salaries are excellent, and consistent with your high level of responsibility. Our benefits are liberal and comprehensive. The opportunity for personal, financial and professional growth is virtually unlimited.

If you feel your ideas are worth more than the Suggestion Box . . .
**Call 203-348-4291 COLLECT, any week-day from 9 AM-5 PM
and ask for Lawrence Bohn**

If unable to call, please submit your resume, including current and desired earnings, to his attention.

ALL REPLIES WILL BE HELD IN STRICTEST CONFIDENCE

**The Bunker-Ramo Corporation will relocate you,
all expenses paid, if you now live over 40 miles from
our Stamford, Connecticut Headquarters (less than one hour from New York City)**



THE BUNKER-RAMO CORPORATION
BUSINESS AND INDUSTRY DIVISION
445 FAIRFIELD AVENUE • STAMFORD, CONNECTICUT 06904

An equal opportunity employer

CIRCLE 969 ON READER SERVICE CARD

SEARCHLIGHT SECTION

"SEARCHLIGHT" is Opportunity Advertising

—to help you get what
you want—to help you
sell what you no longer
need.

Take Advantage Of It

"THINK SEARCHLIGHT FIRST"

For Every Business Want

AUTOTRACK MOUNT

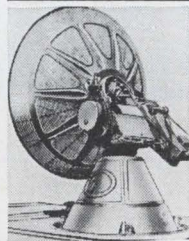

360 degree azimuth, 210 degree elevation sweep with better than 1 mil. accuracy. Missile velocity acceleration and slewing rates. Ampidyne and servo control. Will handle up to 20 ft. dish. Supplied complete with control chassis. In stock—immediate delivery. Used world over by NASA, USAF, MP-61-B. Type SCR-584. Ideal satellite tracking. Large spare parts inventory for back-up.

ANTI-AIRCRAFT GUN MOUNT

Will handle 6,000 lbs. rapid slew through 360° azimuth, 180° elevation. Mobile.

PULSE MODULATORS

250 KW HARD TUBE PULSER

Output 16 kv 16 amp. Duty cycle .002. Pulses can be coded. Uses 5D21, 715C or 4PR60A. Input 115 v 60 cy. AC \$1200 ea.

MIT MODEL 9 PULSER 1 MW—HARD TUBE

Output 25kv 40 amp., 30kr 40 amp. max. Duty cy. .002. .25 to 2 microsec. Also 5 to 5 microsec. and .1 to .5 microsec. Uses 6C21. Input 115v 60 cycle AC. Mfg. GE. Complete with driver and high voltage power supply. Ref: MIT Rad. Lab. Series, Vol. 5, p. 152.

2 MEGAWATT PULSER

Output 30 kv at 70 amp. Duty cycle .001. Rep. rates. 1 microsec. 600 pps. 1 or 2 msec. 300 pps. Uses 5948 hydrogen thyratron. Input 120/208 VAC 60 cycle. Mfr. GE. Complete with high voltage power supply.

18 MEGAWATT PULSER

Output 150KV at 120 amps. Rep. rate: 50-500 PPS. Pulse length: 5 msec. 15 KV 120 amp. into pulse transformer. Rise time 1.5 msec. Filament supply 5V 80 amp. incl. 17.5KV 1.5 amp DC power supply. Input: 220V 60 cy AC.

SCR 584 AUTOTRACK RADARS

Our 584s in like new condition ready to go, and in stock for immediate delivery. Ideal for telemetry research and development, missile tracking, satellite tracking. Fully Deso. MIT Rad. Lab. Series, Vol. 1, pps. 207-210, 228, 284-286. Comp. Inst. Bk available \$25.00 each.

HUNDREDS MORE IN STOCK
LARGEST RADAR
INVENTORY
IN WORLD.
WRITE
FOR
CATALOG
ON YOUR
LETTERHEAD

AUTOMATIC TRACKING SYSTEM

Sci. Atl. Mod. 3101-J70 Antenna Pedestal. AZ-EL 15 deg. per second rated speed. 23 inch dia. bearing. Complete w/control console & mag. amplifiers. Also in stock complete Glo-track receiving system for 200-400 MHz telemetry band including 12' square quad. Helix. All part of Atlas missile instrumentation system.

AN/GSS-1 PASSIVE TRACKER

10 cm passive automatic tracking system with 6 foot parabola. Complete, mounted on van. Supplied by GE for Atlas instrumentation system.

MICROWAVE SYSTEMS

SPARE PARTS IN STOCK

Nike Ajax, Nike Hercules, M-33, MPS-19, TFS-ID, TFS-10D, FFS-6 SPSS, SCR-584, MPQ-18, Mod. Z.

200-2400 mc. RF PKG

Continuous coverage, 30 Watts Cw nominal output. Uses 2C39A. Price \$575.

L BAND RF PKG

20 KW peak 990 to 1040 MC. Pulse width .7 to 1.2 micro sec. Rep. rate 180 to 420 pps. Input 115 vac incl. Receiver \$1200.

200-225 mc RADAR SYSTEM

1 Megawatt output, 200 nautical mile range for long range detection of medium and high altitude jet aircraft as well as general search. AN/TPS-28.

AN/GMD-1B RAWIN RADAR

L-Band Radionode Tracking System. Complete, new cond. in stock for immed. del. AN/GMD-2 computer mfg. Gen'l Mills also in stock.

500 KW L BAND RADAR

500 kw 1220-1359 msc. 1600 nautical mile search range P.R.I. and A scopes. MTT, thyratron mod 5326 magnetron. Complete system.

C BAND AUTOTRACK

1 Megawatt 10 ft. Parabola. Sperry.

AN/GPG-1 SKYSWEEP TRACKER

3 cm. auto. tracking radar system. Comp pkg. w/indicator sys. Full target acquisition & auto. tracking. Input 115v 60 cy. new. In stock for immed. del. Entire sys. 6' x 3' x 10'. Ideal for infrared tracker, drone tracker, missile tracker, I & D

INDICATOR CONSOLES

AN/SPA-4A. PPI 10", range to 300 mi.
VJ-1 PPI 12", Range to 200 mi.
VL-1 RH1 12" to 200 mi. 60K ft.

Radio-Research Instrument Co.

45 W. 45th St.. New York, N.Y. 10036 ■ 212-586-4691

CIRCLE 970 ON READER SERVICE CARD

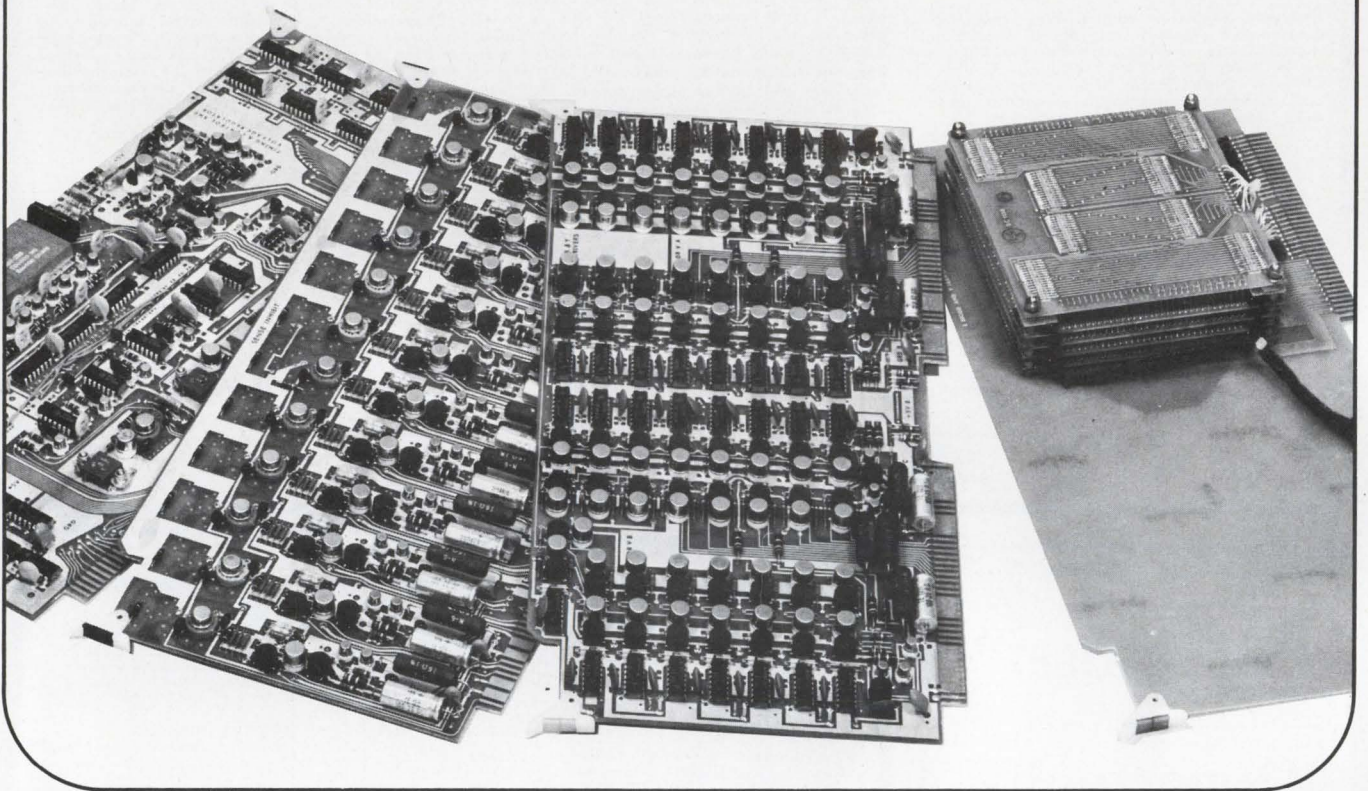

Datacraft's DC-34 Core Memory: 4K x 18 capacity, 750 nSec cycle. A revolution at \$1776 each*.

Our DC-34 core memory is a bunch of cards waiting for a frame that has sockets and a couple of power supplies. You tick off the configuration and we shuffle the cards. We'll work with any length word up to 40 bits and still stick with our standard core planes. And we'll stack our planes up against your total memory requirement — the sky's the limit. Speed is your option, not ours. Go ahead and test us. We haven't found any track too fast for our DC-34. The make-or-buy decisions are all on our side. Buy.

Describe your Central Processor and we'll give you a memory. Let your engineers see their families this weekend: Datacraft already figured out how to build your CPU memory.

*Price quoted is for quantities of 100 or more, plus applicable taxes and options desired.

Call your nearest
Datacraft
 Memory Man.

Datacraft Corporation • P. O. Box 23550, Ft. Lauderdale, Fla. • (305) 933-2651
 Southeast: (305) 423-7615 • Mid-Atlantic: (215) 265-5800 • New York: (516) 482-3500 • New England: (617) 245-9530 • East Central: (216) 243-6500 • West Central: (312) 775-7594 • Southwest: (713) 643-2114 • Rocky Mountain: (303) 794-4231 • Far West: (213) 542-5515

Airborne Instruments Laboratory Campbell-Mithun Inc.	83	Hewlett Packard New Jersey Division McCarthy Scelba & DiBiasi Adv. Agency Inc.	170-171	Signalite Inc. Sub. of General Instrument Corporation McCarthy, Scelba, DeBiasi Adv. Agency Inc.	74
Airpax Electronics Inc. Tech Communicators Inc.	158	Hewlett Packard Rockaway Division Culver Advertising Inc.	163	Silec Electronics Promotion Vente Publicite	14E-15E
American Lava Corporation Sub. of Minnesota Mining & Mfg. Co. Designers Incorporated	45	Hewlett Packard San Diego Division Lennen & Newell Inc.	71	Siliconix Inc. Robertson West Inc.	6
Ancrona Corporation Wilhelm Bacher Werbung	18E	Hitachi Metals Ltd. Asia Adv. Agency Inc.	205	Simpson Electric Company Amerad Advertising Service Inc.	151
Applied Digital Data Systems Inc. Shaw Elliott Inc.	10-11	Howard Industries Inc. K & A Inc. Advertising Institute of Electrical & Electronic Engineers	107	S. P. Elettronica Studio Sergio Rosata	7E
Applied Materials Hall Butler Blatherwick Inc.	60-61	Alpaugh Advertising	187	Sprague Electric Company Harry P. Bridge Company	7
Augat Incorporated Horton Church & Goff Inc.	165	Interelectronics Inc. Samuel H. Meyer Advertising	187	Stackpole Carbon Company Electronics Component Division Thomas/Farragher and Associates Inc.	82
Barnstead Co. Div. of Sybron Corporation Creamer, Trowbridge, Case & Bascord Inc.	188	International Crystal Mfg. Co. Robert V. Freeland & Associates	28	Susumu Industrial Co. Ltd. Kyokuto Kikaku Co. Ltd.	204
Beckman Instruments Inc. Electronic Instrument Division N. W. Ayer/Jorgensen/MacDonald Inc.	15	International Electronic Research Corp. Van Der Boom, McCarron Inc. Advertising	56-57	Sylvania Electric Products Inc., Electronic Components Group Doyle Dane Bernbach Inc.	79
Beckman Instruments Inc. Helipot Division N. W. Ayer/Jorgensen/MacDonald Inc.	155	Itoh C. & Co. Ltd. Dentsu Advertising Ltd.	169	Systron-Donner Corporation Bonfield Associates Inc.	17
Blue M Electric Company South Suburban Advertising	186	ITT Semiconductor Division Neals & Hickok Inc.	139	Takeda Riken Industry Co., Ltd. Shinwa Advertising Co., Ltd.	204
Bourns Incorporated Trimpot Division Lester Company, The	161	JFD Electronics Corp., Components Division Delphi Advertising Inc.	152	Tec Incorporated Stevenson And Associates Inc.	46
Branson Instruments Industrial Cleaning Division Doremus and Company, Inc.	25	Kelsey Hayes Company, Heintz Division Zimmer, Keller and Calvert Inc.	136-137	Tektronix Inc. Dawson Inc.	47
Buckbee-Mears Company Midland Associates Inc.	147	Kikusui Electronics Corporation General Advertising Agency Inc	196	Telecommunications Division of Canadian Marconi Conti Adv. Agency Inc.	173
Burr Brown Research Corp. N. A. Winter Advertising Agency	16E	Krohn-Hite Corporation Ingalls Associates Inc.	49-50	Teradyne Inc. Quinn & Johnson Advertising Inc.	43
Burroughs Corporation Electronic Components Division Conti Advertising Agency Inc.	86	Littlefuse Incorporated Burton Browne Advertising	156	Texas Industrial Commission The Pittuk Group Advertising	199
Bussmann Mfg. Division of McGraw Edison Company Henderson Advertising Company	53	Logimetrics Division of Slatn/Fin Corporation Greenvale Marketing Corporation	75	Texas Instruments Incorporated Components Group Albert Frank Guenther Law Inc.	111
Cambridge Thermionic Corporation Chirurg & Cairns Inc.	199	Lorlin Industries Information Technology Associates	197	Texscan Corporation MacGill/Ross Inc.	154
Cherry Electrical Products Corporation Kolb/Tookey and Associates Inc.	103	LTT Publibel	8E-9E	Triplet Electrical Instrument Company Byer and Bowman Advertising	142
C & K Components Inc. Van Cristo Associates	199	McGraw-Hill Professional & Reference Book Division	195	TRW Semiconductors Inc. Fuller & Smith & Ross Inc.	62
Consolidated Reactive Metals Inc. Marc Dorian Inc.	22	Magnecraft Electric Company Mills, Fife and MacDonalds Inc.	167	Trygon Electronics Inc. Technical Industrial & Scientific Marketing Inc.	14
Cosmicar Optical Co. Ltd. Matsushita Inc.	206	Marconi Instruments Ltd. Taylor Advertising Ltd.	23E	United Aircraft Electronic Components Cunningham & Walsh Inc. Advertising	70, 140
CRC SPI	10E	Markem Corporation Creamer, Trowbridge, Case & Basford, Inc.	27	United Systems Corporation Advertising & Merchandising Inc.	37
Dale Electronics Incorporated Sub. of Lionel Corporation Swanson, Sinkey, Ellis Inc.	3rd Cover	Martin Marietta Corporation Redmond Marcus & Shure	81	United Transformer Company, Division of TRW Inc. Fuller & Smith & Ross Inc.	76
Damon Corporation Ingalls Associates, Inc.	131	Matsushita Electric Corporation of America Dentsu Corporation of America	30-31	Utah Power & Light Company Gillham Advertising Inc.	206
Datacraft Neals & Hickok Inc.	202	Matsuo Electric Co., Ltd. Daiko Advertising Inc.	150	U-Tech a Division of Industrial Physics and Electronics Company Ross Clay Advertising	160
Davis Publications Kameny Associates Inc.	204	Mico Instruments Company N. W. Ayer & Son Inc.	190	Varo Inc. Tracy Locke Inc.	198
Dow Corning International Ltd. Marsteller International S. A.	4E-5E	Mico Switch Division of Honeywell N. W. Ayer & Son Inc.	32	Victoreen Instruments Division Dix and Easton Inc.	24
Eastman Kodak Company PCIM Market Development Rumrill Hoyt Incorporated	183	Mitsubishi Electric Corporation Hakuhodo Inc.	162	Vidar Corporation, Instrumentation Division Bill Fisher Advertising	85
E-H Research Labs Inc. Steedman, Cooper and Busse Advertising	23	Motorola Semiconductor Products Inc. Lane & Wampler Advertising Inc.	35-36, 69	Wang Laboratories Impact Advertising Inc.	8
Electro Motive Mfg. Co., Inc. Culver Advertising Inc.	157	National Electronics Inc. Sub. of Varian Associates Connor-Sager Associates Inc.	48	Waters Manufacturing Inc. Goldman-Daniels Advertising	26
Electro Nuclear Laboratories Hal Lawrence Inc.	84	National Semiconductor Corp. Hall Butler Blatherwick Inc.	12-13	Westinghouse Semiconductor Division Ketchum MacLeod and Grove Inc.	174-175
Electronics Management Center Ries Cappiello Colwell Inc.	182-205	New Hermes Engraving Machine Corp. Lester Harrison Advertising Inc.	193	Weston Instruments Inc., Archbald Div. Arndt Preston Chapin Lamb & Keen Inc.	177
Executone Incorporated, Printact Relay Division J. A. Richards	156	Ney & Company J.M. Peck Adams Inc.	196	Weston Instruments Inc., Lexington Division Larcom Randall Advertising Inc.	149
Fairchild Semiconductor Inc. Chiat Day Inc.	20-21	N. F. Circuit Design Block Co. Norton Associates Inc.	178	Weston Instrumtns Inc. Newark Division Arndt. Preston Chapin Lamb & Keen Inc.	73
Fairchild Systems Technology Hall Butler Blatherwick Inc.	58-59	Norton Associates Inc. J. J. Coppo Company	178	White S.S. Div., of Pensalt Corp. W. L. Towne Company Inc.	72
General Instrument Corporation Semiconductor Products Division Norman Allen Associates	193	Olympus Corporation Kameny Associates Inc.	191	Williams Precious Metals, Div. of Williams Gold Refining Co. Inc. Stahlka, Faller & Klenk Inc.	172
General Radio Company Horton, Church & Goff Inc.	2nd Cover	Omron Tateishi Electronics Company Dai-Ichi International Inc.	18-19	Wiremold Company The Charles Brunelle Company	193
Gordos Corporation Halloff & Caine Associates	187	Pechiney St. Gobain PEMA Phillips N. V. Pit/Tmi Division Marsteller International S. A.	24E	Xerox Corporation Hutchins Advertising Company Inc.	179
Gould Inc. Brush Instruments Carr Liggett Advertising Inc.	184	Phillips N. V. Pit/Power Supplies Division Marsteller International S. A.	2E		
Gould Inc. Gaging & Control Division Carr Liggett Advertising Inc.	80	Plasmadyne, A Geotel Company The Philips Agency of California Inc.	52		
Gould Inc. Graphics Carr Liggett Advertising Inc.	54-55	Plessey Components Rumrill Hoyt Inc.	21E		
GPS Corporation Goldman and Daniels Inc.	44	Polytechnic Institute of Brooklyn Pomona Electronics Company Buxton Advertising Agency	153		
Grayhill Incorporated Carr Liggett Advertising Inc.	196	Princeton Applied Research Corporation Mort Barish Associates Inc.	198		
Guardian Electric Mfg. Company Kolb/Tookey and Associates Inc.	29	Radio Corporation of America Al Paul Lefton Company	38		
Gudebrod Bros Silk Co., Electronics Division Ramsdell, Bright & Nathans Inc.	138	Redcor Corporation Management Communication Consultants Inc.	4th Cover		
Heath Company, Sub. of Schlumberger Ltd. Advance Advertising Services	51	Rhode & Schwarz San E Denki Company Limited Sanko Sha Advertising Agency Co. Ltd.	16		
Hewlett Packard Loveland Division Tallant/Yates Advertising	1	Schauer Manufacturing Corporation Nolan, Keeler & Stites	168		
Hewlett Packard Microwave Division Lennen & Newell Inc.	141	SDSA Public Service Neully	11E to 13E		
Hewlett Packard Mt. View Lennen & Newell Inc.	2	Sescosem Sharp Corporation Dai-Ichi International Inc. Advertising	6E		
		Sierra Electronic Operation, Philco Ford Corporation Hal Lawrence Inc.	194		
			180		

Classified & Employment Advertising

F.J. Eberle, Manager 212-971-2557	
EMPLOYMENT OPPORTUNITIES	201
Atomic Personnel Inc.	200
Bunker Ramo	201
Westinghouse Electric Corp.	200
EQUIPMENT (Used or Surplus New) For Sale	
Radio Research Instrument Co.	201
For more information on complete product line see advertisement in the latest Elec- tronics Buyer's Guide	
Advertisers In Electronics International	

10 nanoV Resolution

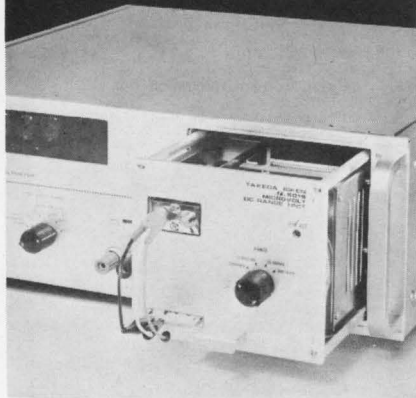

-TR-6018 Microvolt DC Range Unit permits DC voltage measurements at a resolution of 10 nanovolts. Input circuit employs a floating and guarded system. Input cable features a special conductor having an extremely small thermoelectric force. Main unit: **-TR-6515** autoranging, integrating digital voltmeter.

Specification

- * Range: 300 μ V, 3, 30mV f.s.
- * Resolution: 10 nanoV
- * Accuracy: $\pm 0.02\%$ of reading
 ± 1 digit
- * CMR: 160dB (DC)

TR Takeda Riken Industry Co., Ltd

1-32-1, Asahi-cho, Nerima-ku, Tokyo 176, Japan
Tel: Tokyo 930-4111
Cables: TRITRONICS TOKYO

Agents:
Liton Precision Products International Inc.
Germany, France, Holland, Belgium,
Luxemburg, England, Switzerland.
Ing. S & Dr. Guido Belotti Ltd Italy
K. Juul Hansen Denmark
E. Nores Finland
Carl-Eric Larsson Sweden

Advertising Sales Staff

Dan McMillan III [212] 971-3468
Associate Publisher
Wallis Clarke [212] 971-2187
Advertising Sales Service Manager
Tomlinson Howland [212] 971-6792
Promotion Manager
Warren H. Gardner [212] 971-3139
Eastern Advertising Sales Manager
Atlanta, Ga. 30309: **Charleton H. Calhoun, III**
1375 Peachtree St., N.E.
[404] 892-2866
Boston, Mass. 02116: **William S. Hodgkinson**
McGraw-Hill Building, Copley Square
[617] CO 2-1160
Cleveland, Ohio 44113: **William J. Boyle, 55**
Public Square, [216] SU 1-7000
New York, N.Y. 10036
500 Fifth Avenue
James R. Pierce [212] 971-3615
John A. Garland [212] 971-3617
Michael J. Stoller [212] 971-3616
Philadelphia, Pa. 19103:
Jeffrey M. Preston
6 Penn Center Plaza,
[215] LO 8-6161
Pittsburgh, Pa. 15222: **Jeffrey M. Preston,**
4 Gateway Center, [412] 391-1314
Rochester, N.Y. 14534: **William J. Boyle,**
9 Greylock Ridge, Pittsford, N.Y.
[716] 586-5040
Donald R. Furth [312] MO 4-5800
Midwest Advertising Sales Manager
Chicago, Ill. 60611: **Kenneth E. Nicklas**
Ralph Hanning 645 North Michigan Avenue,
[312] MO 4-5800
Dallas, Texas 75201: **Richard P. Poole, 1800**
Republic National Bank Tower,
[214] RI 7-9721
Houston, Texas 7702: **Richard P. Poole**
2270 Humble Bldg. [713] CA 4-8381
Detroit, Michigan 48226: **Ralph Hanning,**
856 Penobscot Building
[313] 962-1793
Minneapolis, Minn. 55402: 1104 Northstar
Center [612] 332-7425
St. Louis, Mo. 63105: **Kenneth E. Nicklas,**
The Clayton Tower, 7751 Carondelet Ave.
[314] PA 5-7285
James T. Hauptli [415] DO 2-4600
Western Advertising Sales Manager
Denver, Colo. 80202: **David M. Watson,**
Richard W. Carpenter
Tower Bldg., 1700 Broadway
[303] 266-3863
Los Angeles, Calif. 90017: **Ian C. Hill,**
Bradley K. Jones, 1125 W. 6th St.,
[213] HU 2-5450
Portland, Ore. 97204: **James T. Hauptli,**
Don Farris, 218 Mohawk Building,
222 S.W. Morrison Street,
Phone [503] 223-5118
San Francisco, Calif. 94111: **James T. Hauptli,**
Don Farris, 255 California Street,
[415] DO 2-4600
Pierre Braude Tel: 727 73 01: Paris
International Director
Paris: **Denis Jacob**
17 Rue-Georges Bizet, 75 Paris 16, France
Tel 727 33 42, 727 33 60
United Kingdom and Scandinavia
London: **Oliver Ball, Tel: Hyde Park 1451**
34 Dover Street, London W1
Milan: **Robert Saidel, Roberto Laurerl Jr.**
1 via Baracchini Phone 86-90-656
Brussels: **Denis Jacob**
27 Rue Ducale Tel: 136503
Frankfurt/Main: **Hans Haller**
Elsa Brandstroem Str. 2
Phone 72 01 81
Geneva: **Pierre Braude**
1 rue du Temple Phone: 31 95 60
Tokyo: **Noboru Matsumoto, McGraw-Hill**
Publications Overseas Corporation,
Kasumigaseki Building 2-5, 3-chome,
Kasumigaseki, Chiyoda-Ku, Tokyo, Japan
[581] 9811
Osaka: **Akihiko Kamesaka, McGraw-Hill**
Publications Overseas Corporation, Kondo
Bldg., 163, Umegae-cho Kita-ku [362] 8771
Australasia: **Warren E. Ball, IPO Box 5106,**
Tokyo, Japan

Business Department

Stephen R. Weiss, Manager
[212] 971-2044
Thomas M. Egan,
Production Manager [212] 971-3140
Maury D'Gongora,
Assistant Production Manager [212] 971-2045
Dorothy Carmesin, Contracts and Billings
[212] 971-2908
Frances Vallone, Reader Service Manager
[212] 971-2865

We'll
give you
a prize
if you
give us
a project.



Did you ever invent an electronic gadget? Or re-design an existing circuit into a better one? Perhaps you conjured up a gizmo that just blinks its lights.

Davis Electronics Group publishes magazines aimed at the electronic experimenter. Our readers would enjoy putting together what you designed.

Should we publish plans for your gadget, we'll give you another you'll enjoy. Like a Honda 50, an air conditioner, any of a dozen other things you'd like to have.

Don't pre-judge your own project as too complicated, too simple, or too expensive. If it works as you say it does, chances are we'll like it, too.

Tonight, drop us a note telling what you've built, how long it took to build, and the approximate cost of parts. If you have ten original ideas, send all ten.

Your Christmas presents could come in August, September, October.

DAVIS PUBLICATIONS

229 Park Ave. South, N.Y., N.Y. 10003

Science and Electronics Science & Mechanics Elementary Electronics

Circle 246 on reader service card

ECONOMICAL Thin Film!

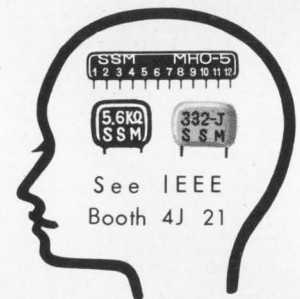

See IEEE
Booth 4J 21

What's needed for memory system is everlasting high accuracy. SSM's components are the very ones satisfying superior reliability.

- Plate-ohm: evaporated metal film resistor.
- Pla-module: thin film modulated C-R circuit.
- Pla-con: organic thin film capacitor by plasma reaction.

SUSUMU INDUSTRIAL CO., LTD.

Minami Bldg. 1-12 Ebisuminami
Shibuya-ku, Tokyo, Japan.
TEL: Tokyo (03) 712-5990
TELEX: No. 246-6270

**Pulling the nations
of the world
closer together...**

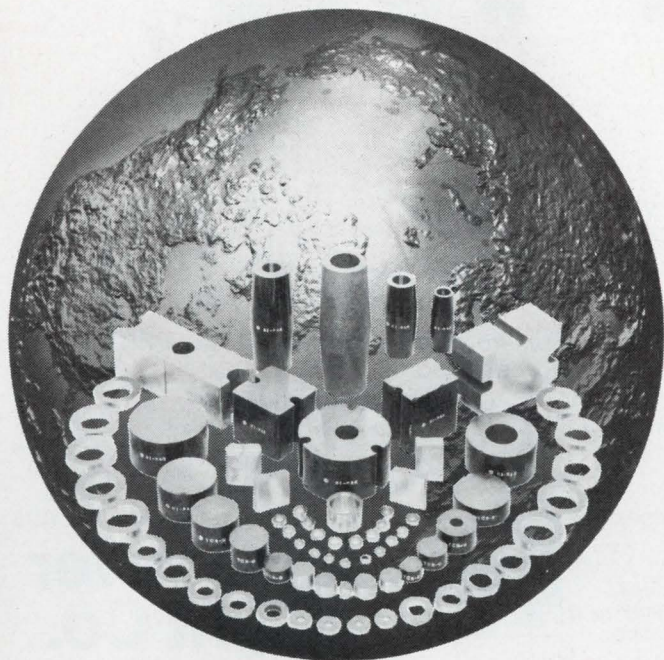

Hitachi Cast Magnets

Today's communications systems could not exist without high-grade permanent magnets. Cast magnets in particular are becoming increasingly important. Hitachi Metals produces some of the best. Cast magnets for microwave communications. Compactly designed and finished to close tolerances. Featuring high coercive force and high energy product plus magnetic field uniformity and stability.

At Hitachi Metals, magnet production is integrated. Backed by decades of experience, and a tradition of quality workmanship. Hitachi Metals makes full use of technology as modern as tomorrow.

The results speak for themselves. In communications equipment around the world.

Typical Hitachi Cast Magnets and Properties

Type	Residual Induction (Br) gauss	Coercive Force (Hc) oersteds	Energy Product (B×H)max. ×10 ⁻⁶
HI-MAG I (ALNICO-5-7)	13,500~14,500	700~750	7.0~8.2
HI-MAG II (ALNICO-5-7)	13,000~14,000	680~780	6.8~8.0
YCM-8B (ALNICO-8)	8,800~9,600	1,380~1,500	4.8~5.5

Hitachi cast magnets are also used in **meters, generators, motors, telephone equipment, magnetos** and many other types of equipment. For further information, please contact:



Head Office
Chiyoda Bldg., Marunouchi, Tokyo, Japan
Hitachi Metals America, Ltd.
Magnet Materials Sect.
437 Madison Ave., New York, N.Y. 10022.
U.S.A. Tel. 212-758-5255

LSI

The Changing Interface

Medium and large scale integration are slated to have major impact on the electronics industry. The effects are already being felt — not only on systems and component design — but on fundamental, traditional relationships between equipment builders and component suppliers.

Important trends that will affect your profession, your job, your company, are explored in LSI: THE CHANGING INTERFACE, a 100-page illustrated volume published by McGraw-Hill's Electronics/Management Center.

In THE CHANGING INTERFACE, leading design engineers and managers, the men responsible for guiding their companies through the next generation of electronics, discuss the problems that LSI/MSI are stirring up — and offer their solutions.

Here are some of the vital topics covered.

- Implications of LSI on the Electronics Market**
- The Rationale for an In-House IC Capability**
- The Component Maker's Responsibility vs. the System Builder's Responsibility**
- Masks and Computer-Aided Design at the Interface**
- The Testing Interface**
- How IBM and Bell Laboratories Deal with the Interface Problem**
- Controversies and Future Trends in LSI**

Copies of LSI: THE CHANGING INTERFACE are available now at \$10 per copy. Fill in and return the coupon below. If you send a check now, we'll pay the cost of postage and handling.

Electronics/Management Center
330 West 42nd St.
New York, N.Y. 10036

Attn. Mr. Wayne Cowart

Please send _____ copies of LSI: THE CHANGING INTERFACE at \$10 per copy.

Name _____ Title _____

Company _____

Company Address _____

City _____ State _____

Check enclosed for _____ Bill me
 Bill Company, P.O. Number _____

PRETTY FACE FORCE

Sure our women are pretty. But in the Mountain West, they have a little something more going for them. Education.

In Utah the girls go to school longer than anywhere else in the country.* But then, so do the boys.

So when they do get out, they're brighter, better educated. More stable too.

When you add all those together you come up with a labor force that's more than just a pretty face. It's a pretty way to face the future.

If you're looking for a labor pool that promises profit, remember, in Utah, we deliver.

*The average Utah adult has completed 12.2 years of schooling, compared with the national average of 10.5 years. Source: *Rankings of the States in 1969*, published by the National Education Association.



For more information on Utah's Pretty Face Force, write:

Ask for our new 28 page Brochure

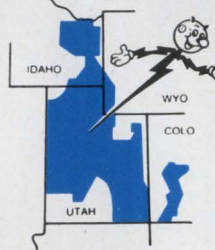

"A Treasure Chest in the Growing West"

Wayne F. Mulcock
Director, Area Development
P.O. Box 899, Dept. E-2a
Utah Power & Light Co.
Salt Lake City, Utah 84110

Utah Power & Light Co.

Circle 224 on reader service card

Perfect Your CCTV System with COSMICAR® lenses



Focal length 15~145mm Aperture f/2.5

A new member to the superb COSMICAR lens family!!

The most efficient **10:1 zoom** lens, unmatched for its optimum performance, both optically and mechanically, with impeccable definition and resolution throughout its entire zoom range.

Also available are scores of other lenses, ranging from 8.5mm to 1,000mm telephoto, zoom and those motordriven among them, for immediate delivery, after being tailored to your specifications.



COSMICAR OPTICAL CO., LTD.

568, Shimoochiai, 2-chome, Shinjuku-ku, Tokyo Cable Address: "MOVIEKINO TOKYO"

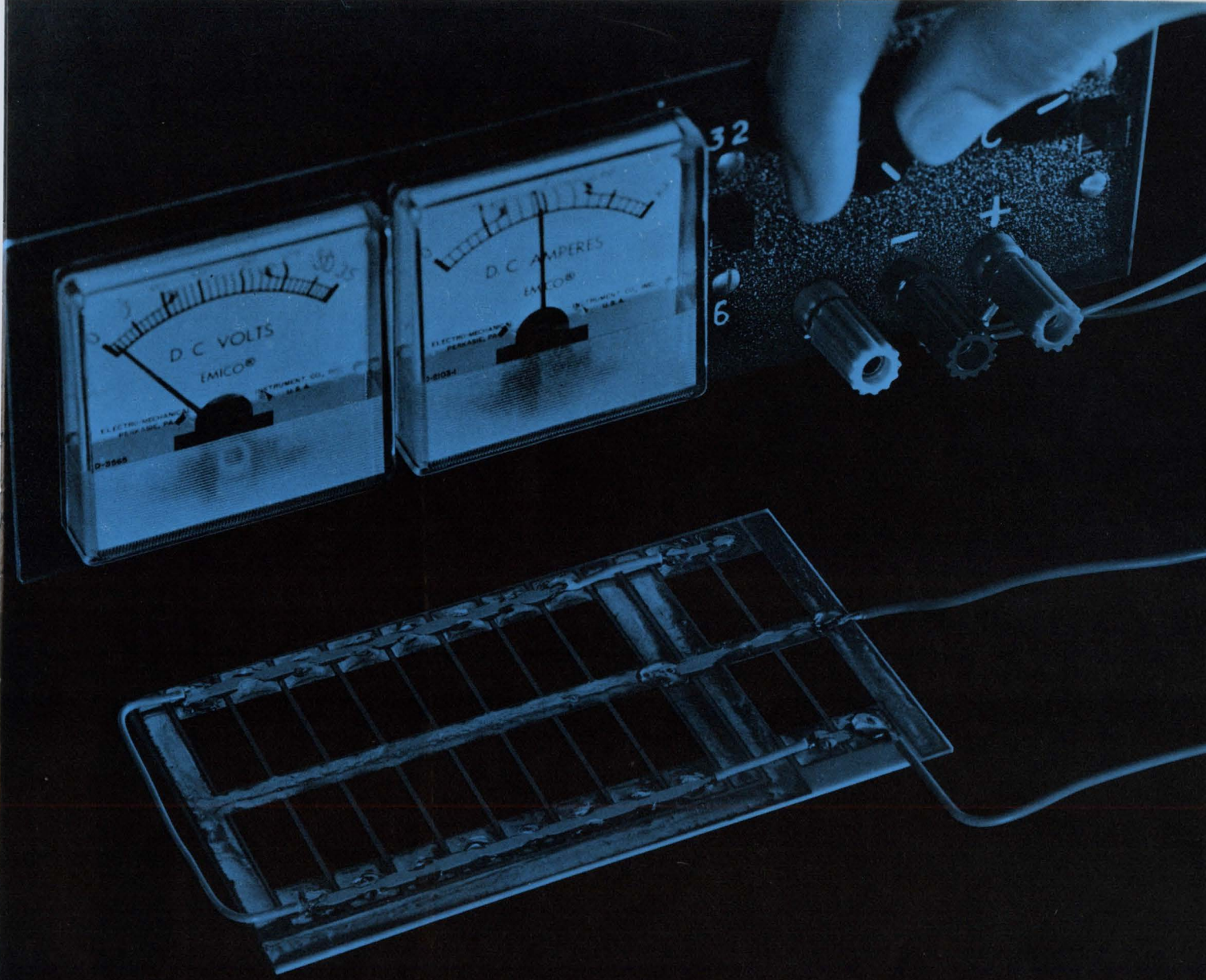

Dale puts the power in thick film networks

Dale makes thick film R-C networks as standard as this dual in-line package and as small as this 1/4-inch square model.



Within this broad capability we've become known as power specialists.

Our ability to work with substrate, heat sink, package density and all the other network variables lets us deliver the power you need—in the size you need. "Big" jobs like the one shown above (5" x 2-1/2", 20 resistors, 60 watts) don't scare us a bit. Whether your next network is tremendous or tiny, give us a shot at it.

PROTOTYPES ON MOST DESIGNS IN LESS THAN THREE WEEKS... Call 402-564-3131 for complete details or write for Catalog A.

GENERAL NETWORK SPECIFICATIONS

Temperature Coefficient: ± 250 PPM max. from -55°C to $+150^{\circ}\text{C}$. T.C. as low as ± 50 PPM in limited resistance ranges.

Tolerance: Standard $\pm 10\%$. As low as 1% when required.

Power Loading: 16 watts/in.² standard with aluminum oxide substrate .015"-.040" thick. Substantially higher with heat sinking and beryllia substrates.

Terminations, Conductors and Land Areas: Platinum gold, palladium gold, gold and silver, depending upon application. Crossovers can be made. Lands for attaching active or passive components can be provided.

Moisture Changes: Meet Method 103, MIL-STD-202.

Resistor Patterns: Thick film resistive materials with resistivities from 1 ohm/sq. to 1 megohm/sq. can be used. Patterns can be made from 1/10 square to 10 squares.

Capacitors: Screened = .01 $\mu\text{fd}/\text{in.}^2$; Chip = up to 5 μfd $\pm 10\%$ to $\pm 20\%$ or GMV. Dissipation Factor = Less than 1.5%. Working Voltage = 50.

Packaging: Dual-in-line packaging can be used with plated Kovar or other types of leads. Also conformal coatings can be applied to modules with wire or ribbon leads. Screened and cured silicone coatings can be used to protect specific areas of the circuit.

DALE ELECTRONICS, INC.
1372 28th Ave., Columbus, Nebr. 68601
In Canada: Dale Electronics Canada, Ltd.
A Subsidiary of The Lionel Corporation



Four power levels for SSB

Now . . .

four tubes for SSB. And four power levels—500 W, 1 kW, 5kW, and 10 kW. These rugged Cermolox® tubes, developed from proved, in-use designs, feature new low in feedthrough capacitance and screen and cathode inductance plus superb IM characteristics. Their rugged construction makes them suitable for mobile service in shipboard and airborne equipment as well as in fixed stations.

Available at surprisingly low cost, the four are: 8791, 8792, 8793, and 8794. In addition to their efficient use in SSB service, the tubes are attractive for FM, VHF-TV, and VHF/UHF communications.

See your RCA Representative for details, including prices and delivery. For technical data on specific types, write: RCA Electronic Components, Commercial Engineering, Section **C19T-1**, Harrison, N.J. 07029. In Europe: RCA International Marketing S.A., 2-4 rue du Lièvre, 1227 Geneva, Switzerland.

RCA

8794, 10 kW PEP

8791, 500 W PEP

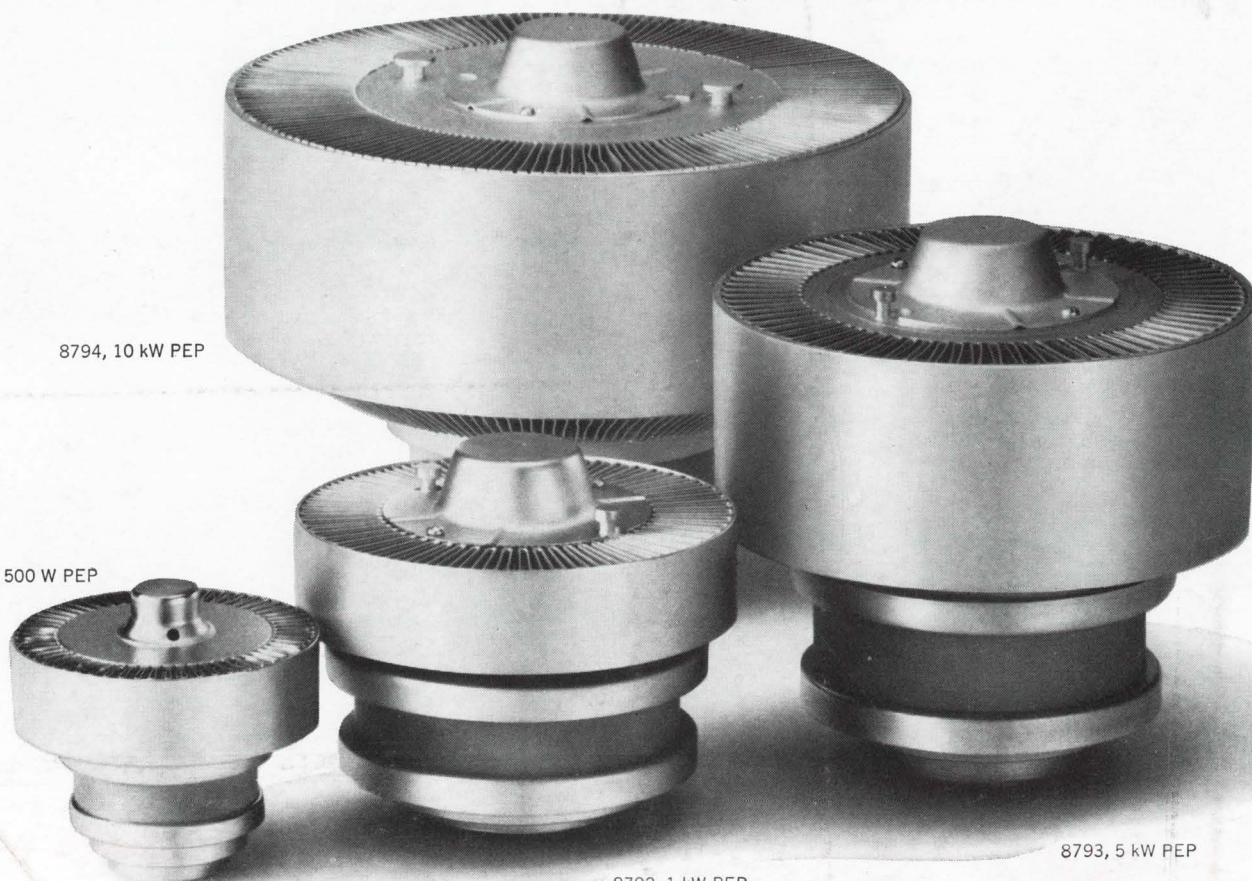

8792, 1 kW PEP

8793, 5 kW PEP