

SEPTEMBER 19, 1974

Instrument makers weigh universal bus standard/67

A new series: practical bipolar-transistor models/114

Making connections with conductive elastomers/122

LIBRARY
STATE TECHNICAL INSTITUTE
AT MEMPHIS

FOUR DOLLARS A McGRAW-HILL PUBLICATION

Electronics®

The AUTOMATIC TESTING GAME

LOSE GAME

FIELD FAILURE
LOSE CUSTOMER

WIN PROFITS

FIELD TEST
satisfy customer
Go to Profits

Pay Bank
100 TIMES COMPONENT VALUE

SYSTEM TEST
REWORK
NO JUMP 2

BAD BOARD
90° BACK
3 SPACES

BOARD SAVE TEST
REWORK
JUMP 2

TAKE CHOICE TO START

INVEST
Go to NEXT SPACE

DON'T INVEST
JUMP 2 SPACES

TEST DEVICE
JUMP TWO

DEAD on arrival
Go BACK TO START

STATE TECHNICAL INSTITUTE
38134
MS NF WALKER
5983 MACON COVE
MEMPHIS TN

Dialight sees a need:

(Need: The widest choice for your every application.)

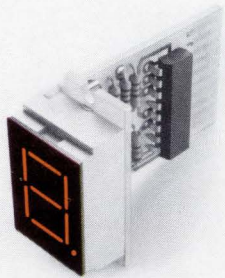

730 SERIES Your choice . . . a red or green LED readout with large 0.625" characters . . . low power, operates with standard IC power supply levels. Comes in plus-minus module. Display uses standard or high brightness LEDs for maximum light output arranged in a seven-segment format. Available with or without on-board decoder/driver. Unique lens design generates bright, highly legible characters.



739 SERIES Save design time and installation costs . . . this LED display assembly is attractively designed in a convenient package with bezel and is ready for instant panel mounting. Available in groups of one or more characters, with or without decoder/driver . . . characters are 0.625" and come with either green or red LEDs in seven-segment format. Readout offers lowest cost per character for comparable size.

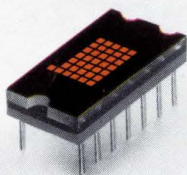

745-0005 Dot matrix LED readout display produces a bright 0.300" high character or symbol display. Has wide angle visibility and is compatible with USASCII and EBCDIC codes. Low power requirements. Mounts into standard 14-pin DIP socket. The display is also available in bezel assemblies with or without code generator.

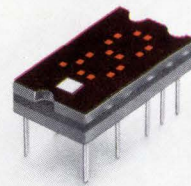

745-0007 LED hexidecimal display with on-board logic operates from 5 to 6 volt supply, low power consumption. Integral TTL MSI chip provides latch, decoder and drive functions. 0.270" character display has wide angle visibility and mounts into standard 14-pin DIP socket.



755 SERIES High brightness planar gas discharge displays in a 0.550" character. Orange color gives high contrast ratio and allows readability to 40 feet even in high ambient lighting. Designed for interfacing with MOS/LSI, displays have an expected life of 100,000 hours or more.

Dialight, the company with the widest choice in switches, LEDs, indicator lights and readouts, looks for needs . . . your needs . . . and then they develop solutions for your every application. No other company offers you one-stop shopping in all these product areas. And no other company has more experience in the visual display field. Dialight helps you do more with these products than any other company in the business, because we are specialists that have done more with them. Talk to the specialists at Dialight first. **DIALIGHT** You won't have to talk to anyone else.

Dialight, A North American Philips Company
203 Harrison Place, Brooklyn, N. Y. 11237
(212) 497-7600

See Dialight.

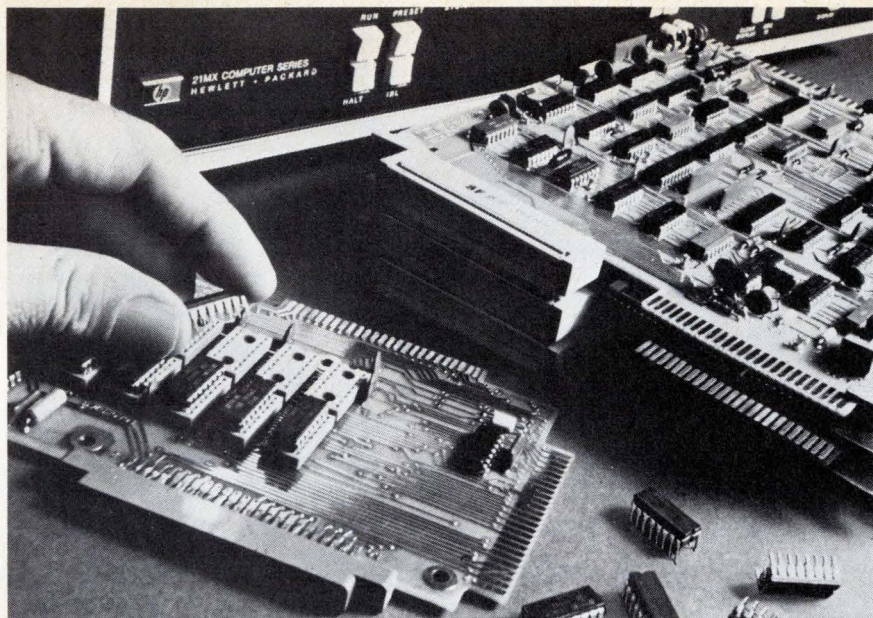

The new 21MX Series for OEM's. Plug-in instruction sets and 4K RAM's. The end of the dead-end computer.

21MX minicomputers are wide open. Write your own computer instructions, or add HP-supplied sets, to run standard routines at hardware speed.

You already know about declining 4K RAM cost. And solid state memory lets you expand without adding cycle time or losing I/O slots.

Pick the processor with the memory and I/O space you need. And get a brownout-proof power supply, memory parity, floating point, unique front panel, EAU, ROM bootstrap, and more. Standard.

Anything that isn't solid state is just plain solid. Traditional HP.

At an untraditional price. Low. Example: a 4K system with all these features, just \$3927.*

Say goodbye to the dead-end computer. Call HP today.

HP minicomputers. They work for a living.

HEWLETT  PACKARD

Sales and service from 172 offices in 65 countries.
1501 Page Mill Road, Palo Alto, California 94304

*Domestic USA OEM price in quantities of 50.

22424

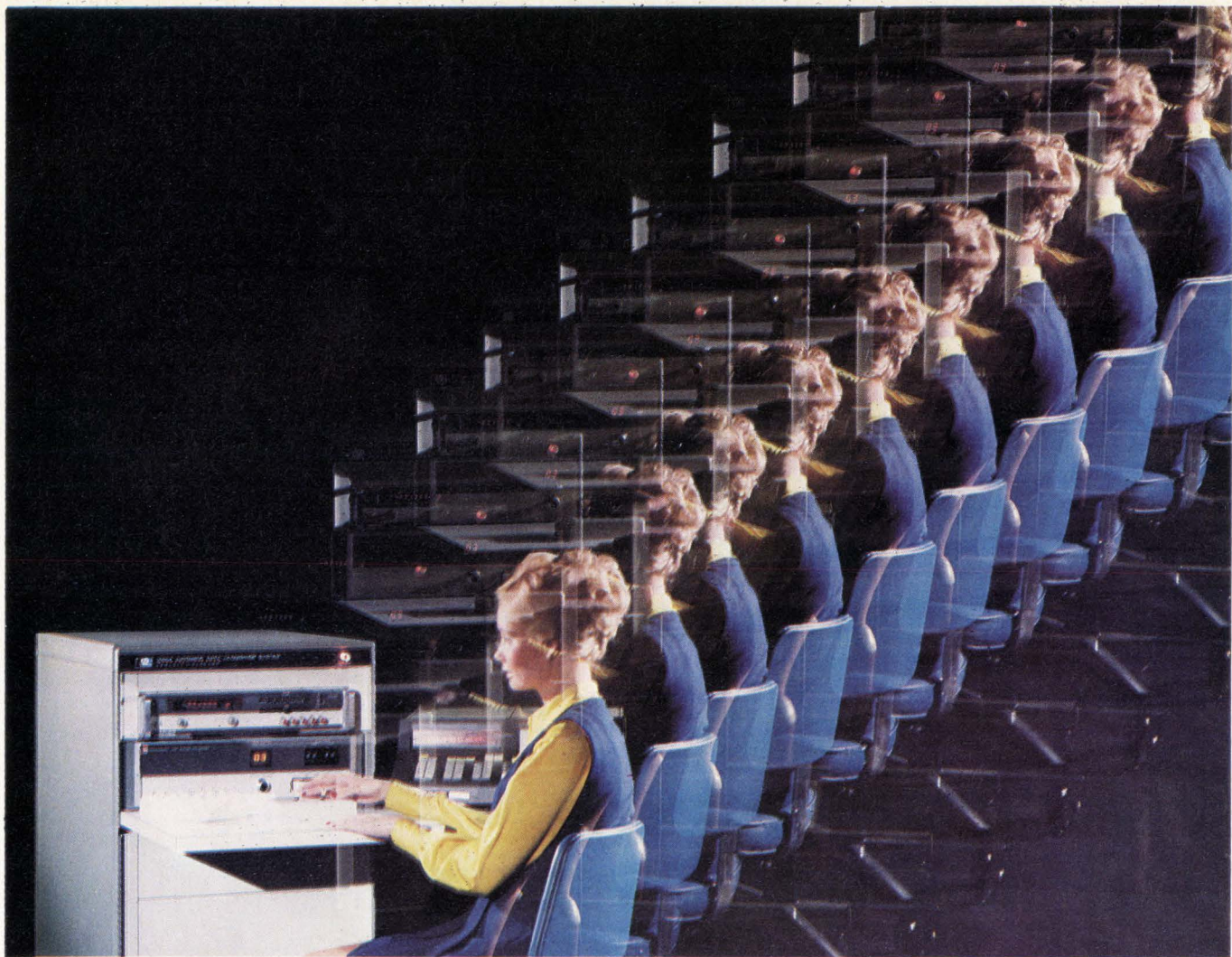

Multiply your output...

...by adding one HP 3050A Automatic Data Acquisition System.

One 3050A can multiply your production output by as much as ten over manual test methods. Or, it can reduce testing time in R&D while boosting your testing capability. HP's 3050A eliminates most manual operations in AC V, DC V and Ohms Measurements. No more manual switching, no more visual monitoring or manual transcribing, no more data analysis... the unit's multi-channel scanner, DVM, and programmable calculator do all those things automatically. This system makes pass-fail decisions on the spot or prints out your test data, in the units you want, for rapid analysis. You get more efficient, more comprehensive testing while reducing testing errors.

Whether you have a manufac-

turing testing or an R&D application, easy-to-learn algebraic or BASIC programming language lets you program the system for your specific testing needs. You can select up to 100 individual channels, change ranges and functions on the DVM, analyze and store data, and print the results... all under calculator control.

Dry-reed relays and DVM resolution to $1 \mu\text{V}$ lets you monitor low-level transducer outputs as well as large AC signals and DC levels to 200V. Computational power of the 9820A calculator controller (or optional 9821A and 9830A) allows you to do calculations and data analysis, thus eliminating data reduction tasks. You can convert measurements to engineering or scientific units, linearize and compensate transducer outputs, calcu-

late average values and standard deviation, perform design computations, and more... all automatically. And an optional page printer and X-Y plotter can save you hours preparing tabulated data and graphs.

Couple this capability with the system's operational simplicity—which lets you free skilled people for other tasks—and you can see why the 3050A is finding wide use in testing and data acquisition applications.

Contact your local HP field engineer for information on applying the 3050A to your testing situation. Or, write Hewlett-Packard.

094/48

HEWLETT  PACKARD

Sales and service from 172 offices in 65 countries.
1501 Page Mill Road, Palo Alto, California 94306

Electronics/September 19, 1974

31 Electronics Review

INDUSTRIAL: Microprocessors make headway in numerical control, 31
LASERS: EIA likes proposed new laser standards, 32
INSTRUMENTS: Time intervals push femtoseconds, 33
COMMUNICATIONS: Computer system to replace phone directories, 34
COMMERCIAL: Printer reproduces videotapes quickly, 36
Digital communications aimed at trucking companies, 36
NEWS BRIEFS: 38
INDUSTRIAL: Smart TV camera improves extrusion, 40
COMMUNICATIONS: Special carriers get big new customer, 42
COMPUTERS: Study may simplify data-network entry, 42

54 Electronics International

WESTERN EUROPE: Microwave makers show gear at Montreux, 54
JAPAN: Injection laser resembles filament, 54
WEST GERMANY: Laser designed for communications links, 54
AROUND THE WORLD: 55

67 Probing the News

INSTRUMENTATION: Makers seek common language, 67
ELECTRONICS ABROAD: Gloom settles over Farnborough, 70
MANPOWER: Three firms unlock source of technicians, 74
MEMORIES: 4-k RAM is alive and well, 76

95 Technical Articles

INSTRUMENTS: Automated testing of components pays off, 95
DESIGNER'S CASEBOOK: Light sensor has high voltage output, 110
Coding a-d converters for sign and magnitude, 110
Getting extra control over output periods of IC timer, 112
COMPUTER-AIDED DESIGN: Modeling the bipolar transistor, 114
Part 1: first-level nonlinear model, 115
COMPONENTS: Conductive elastomers make tiny contacts, 122
ENGINEER'S NOTEBOOK: Circuit adds diagonal to any scope, 126
Analog comparator borrows power from digital panel meter, 128

133 New Products

IN THE SPOTLIGHT: Monolithic op amp has C-MOS output, 133
COMPONENTS: Cherry moves into gas-discharge displays, 136
INSTRUMENTS: Test system has program-editing console, 144
SEMICONDUCTORS: Quad bus driver/receiver is bidirectional, 155
DATA HANDLING: Vacuum tape drive closes price gap, 165
PACKAGING & PRODUCTION: Dry-etch process improved, 175
MATERIALS: 184

Departments

Publishers letter, 4
Readers comment, 6
40 years ago, 10
People, 14
Meetings, 22
Electronics newsletter, 27
News update, 46
Washington newsletter, 51
International newsletter, 57
Engineer's newsletter, 130
New literature, 190
New books, 192

Highlights

The cover: Automated testing is profitable, 95

It's estimated that the cost of correcting a malfunction in today's complex electronic systems jumps tenfold for every production stage through which the fault passes undetected. To catch defects as early as possible and also to minimize labor costs, manufacturers are increasingly turning to automated and computerized testers for their high-volume lines.

Universal bus standard sought for instruments, 67

The International Electrotechnical Commission is meeting this week in Bucharest, Romania, to discuss a proposal for standardizing the interface between all instruments and all instrument peripherals, whatever their place of origin.

How to model large-signal bipolar transistors, 114

Computer-aided design of a circuit containing bipolar transistors is complicated by the existence of several models, which lack both a standard notation and a standard method of parameter measurement. The first article in this three-part series helps the inexperienced computer-user handle both theory and measurements for the simplest nonlinear model.

Conductive elastomers miniaturize contacts, 122

The need for microscopic, shockproof interconnections in pocket calculators, digital watches, and similar applications is met by a novel kind of contact material—an elastomer, usually silicone, filled with carbon or metal particles and molded into buttons perhaps only 0.015 inch high.

And in the next issue . . .

Special report on satellite communications
. . . the new bipolar logic family: 1²L . . .
the advantages of the logic scope.

EDITOR-IN-CHIEF: Kemp Anderson

EXECUTIVE EDITOR: Samuel Weber

MANAGING EDITORS: Lawrence Curran, *News*;
Arthur Erikson, *International*

SENIOR EDITORS: John Johnsrud,
H. Thomas Maguire, Laurence Altman,
Ray Connolly, Stephen E. Scrupski

ART DIRECTOR: Fred Sklenar

ASSOCIATE EDITORS: Howard Wolff,
Gerald M. Walker, Alfred Rosenblatt

DEPARTMENT EDITORS

Aerospace/Military: Ray Connolly

Circuit Design: Lucinda Mattera

Communications & Microwave:

Stephen E. Scrupski

Computers: Wallace B. Riley

Consumer: Gerald M. Walker

Industrial: Michael J. Riezenman

Instrumentation: Stephen E. Grossman

New Products: H. Thomas Maguire

Packaging & Production: Andy Santoni

Solid State: Laurence Altman

COPY EDITORS: Margaret Eastman,
Everett C. Terry, Bill Dunne

ASSISTANT EDITOR: Marilyn Offenheiser

ART: Charles D. Ciatto, *Associate Director*
Patricia Cybulski, *Assistant Director*

PRODUCTION EDITOR: Arthur C. Miller

EDITORIAL SECRETARIES: Janet Noto,
Julie Gorgogliano, Penny Roberts

FIELD EDITORS

Boston: Gail Farrell

Los Angeles: Paul Franson (Mgr.)

Midwest: Larry Armstrong (Mgr.)

San Francisco: Bernard Cole (Mgr.)

Judith Curtis

Washington: Ray Connolly (Mgr.)

Larry Marion

Frankfurt: John Gosch

London: William F. Arnold

Paris: Arthur Erikson

Tokyo: Charles Cohen

McGRAW-HILL WORLD NEWS

Director: Ralph R. Schulz

Bonn: Robert Ingersoll

Brussels: James Smith

London: Marvin Petal

Milan: Peter Hoffmann, Andrew Heath

Moscow: Peter Gail

Paris: Michael Johnson, Richard Shepherd

Stockholm: Robert Skole

Tokyo: Mike Mealey

PUBLISHER: Dan McMillan

DIRECTOR OF MARKETING: Pierre J. Braudé

ADVERTISING SALES SERVICE MANAGER:
Wallis Clarke

BUSINESS MANAGER: Stephen R. Weiss

CIRCULATION MANAGER: Nancy L. Merritt

MARKETING SERVICES MANAGER:

Tomlinson Howland

RESEARCH MANAGER: Margery D. Sholes

Automatic testing is no longer a "luxury," affordable only for military systems. Now it is a necessity that can spell the difference between profit and loss for the electronic-equipment manufacturer. In fact, automatic testing has become such an important part of the manufacturing process that we decided to put together an in-depth report on this crucial cost-cutting and profit-preserving technique.

In the 15-page report that starts on page 95 you'll find a wrap-up on the machines, the methods, and the trade-offs involved in automatic testing. As Steve Grossman, our instrumentation editor, points out in the report's introduction, "the new breed of testers finds jobs all through the life cycle of the product—incoming components, assembled printed-circuit boards, subassemblies, deliverable product, and after-delivery troubleshooting. These automated testers go a long way toward reducing the labor-intensive manual testing of parts and subassemblies."

And, the report even helps you calculate the break-even point, below which not testing may be more cost-effective than investing in automatic test equipment. With this kind of perspective, the special report is, we feel, especially valuable.

A group of electronics companies on the West Coast is unlocking—in more ways than one—a novel source of electronic technicians: San Quentin. The prison near San Francisco is the site of an unusual electronics classroom for which the Bay Area companies put together a course and donated \$50,000 in equipment.

September 19, 1974 Volume 47, Number 19
94,150 copies of this issue printed

Published every other Thursday by McGraw-Hill, Inc. Founder: James H. McGraw 1860-1948. Publication office 1221 Avenue of the Americas, N.Y., N.Y. 10020; second class postage paid at New York, N.Y., and additional mailing offices.
Executive, editorial, circulation and advertising addresses: Electronics, McGraw-Hill Building, 1221 Avenue of the Americas, New York, N.Y. 10020. Telephone (212) 997-1221. Teletype TWX N.Y. 710-581-5234. Cable address: MCGRAWHILL N.Y.

Subscriptions limited to persons with active, professional, functional responsibility in electronics technology. Publisher reserves the right to reject non-qualified requests. No subscriptions accepted without complete identification of subscriber name, title, or job function, company or organization, including product manufactured or services performed. Subscription rates: qualified subscribers in the United States and possessions, Canada, and Mexico \$12.00 one year; \$24.00 three years; all other countries \$25.00 per year, except Japan \$50.00 per year, Brazil \$40.00 per year, Australia and New Zealand \$60 per year, including air freight. Limited quota of subscriptions available at higher-than-basic rate for persons outside of field served, as follows: U.S. and possessions and Canada, \$25.00 one year; all other countries \$50.00. Single copies: \$4.00.

But the innovation is not without its selfish aspect. The companies will have their pick of the two dozen students when they "graduate" for their technician-short plants. You'll find the complete story on this "selfish" yet socially aware project on page 74.

Computer-aided design can be extremely beneficial when it comes to analyzing, say, a circuit containing bipolar transistors. The trouble is that the available models, which must form the basis for any computer-based analysis, can be confusing. For one thing, notations are different. For another, no standard measurement method exist, so a designer is faced with decisions on how to measure the parameters needed to describe his model.

Now, in a three-article series that starts in this issue, we are presenting for the first time a systematic approach to bipolar-transistor modeling for nonlinear analysis. Part 1, which begins on page 114, covers the simplest nonlinear large-signal model, the first-level Ebers-Moll model. Both the theory behind the model and definitive methods for parameter measuring are included.

In subsequent issues we will bring you the other two parts, which will cover the next level of model complexity, accounting for the first-order effects of transistor charge storage (Part 2) and discussing how to measure this model's parameters (Part 3).



Officers of the McGraw-Hill Publications Company: John R. Emery, President; J. Elton Tuohig, Executive Vice President-Administration; Gene W. Simpson, Group Publisher-Vice President; Senior Vice Presidents: Ralph Blackburn, Circulation; Walter A. Stanbury, Editorial; John D. Hoglund, Controller; David G. Jensen, Manufacturing; Gordon L. Jones, Marketing; Jerome D. Luntz, Planning & Development.

Officers of the Corporation: Shelton Fisher, Chairman of the Board and Chief Executive Officer; Harold W. McGraw, Jr., President and Chief Operating Officer; Wallace F. Trendelenburg, Group President, McGraw-Hill Publications Company and McGraw-Hill Information Systems Company; Robert N. Landes, Senior Vice President and Secretary; Ralph J. Webb, Treasurer.

Title registered in U.S. Patent Office; Copyright ©1974 by McGraw-Hill, Inc. All rights reserved. The contents of this publication may not be reproduced in whole or in part without the consent of copyright owner.

Subscribers: The publisher, upon written request to our New York office from any subscriber, agrees to refund that part of the subscription price applying to copies not yet mailed. Please send change of address notices or complaints to Fulfillment Manager; subscription orders to Circulation Manager, Electronics, at address below. Change of address notices should provide old as well as new address, including postal zip code number. If possible, attach address label from recent issue. Allow one month for change to become effective.

Postmaster: Please send form 3579 to Fulfillment Manager, Electronics, P.O. Box 430, Hightstown, N.J. 08520.

A new digital phasemeter that's accurate to $.05^\circ$?

$.05^\circ$ accuracy and $.01^\circ$ resolution
continuous precision measurement
from 0° – 360.00°

no $0/360^\circ$ ambiguity, right down
to readings as small as $.01^\circ$

5 digit Sperry readout

accuracy unaffected by amplitude differences

frequency range 10Hz to 5MHz

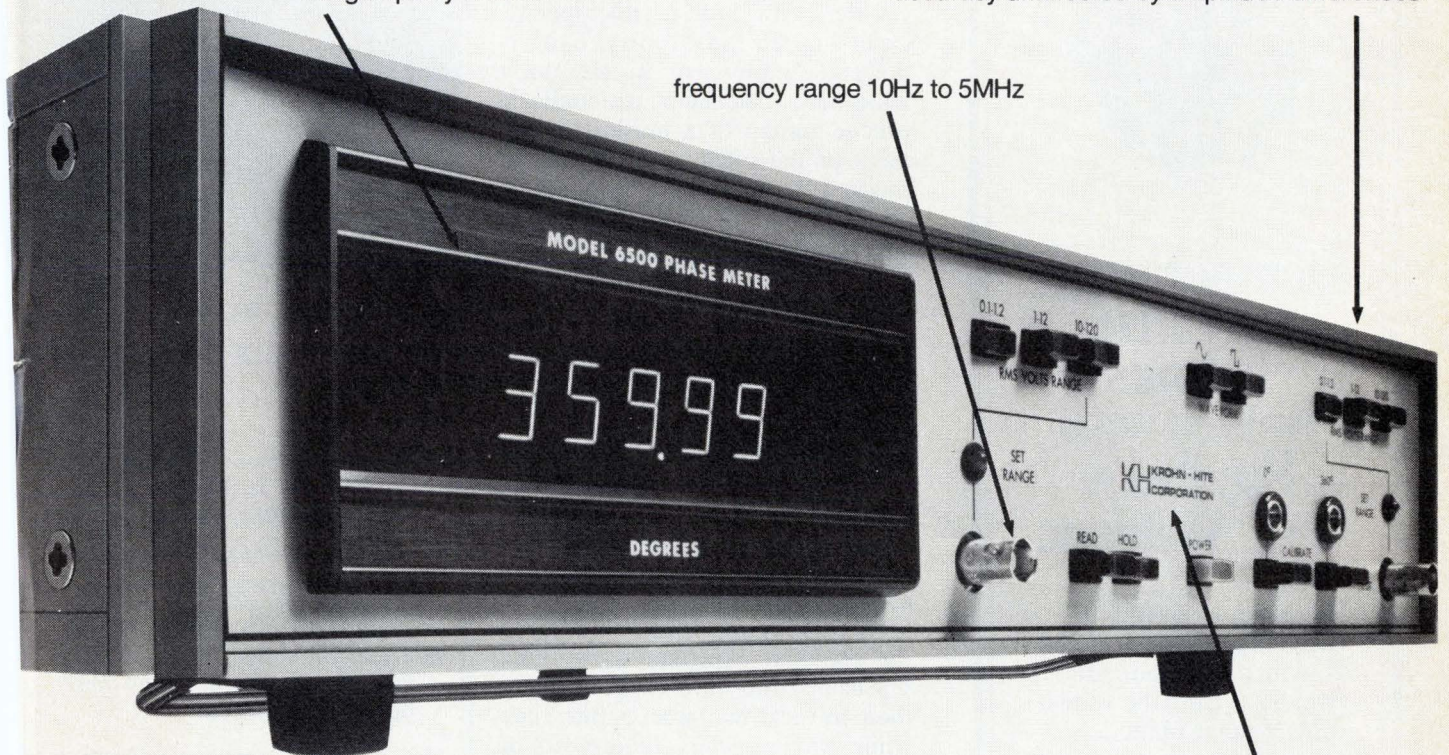

Precisely.

and the best performance
at the best price,
only \$1995.—

for immediate action call
(617) 491-3211, TWX 710
320 6583, or contact your
local KH representative,
listed below.

**KH KROHN-HITE
CORPORATION**
580 Massachusetts Avenue, Cambridge, Massachusetts 02139

SALES OFFICES: ALA, Huntsville (205) 534-9771; ARIZ, Scottsdale (602) 947-7841; CAL, San Jose (408) 292-3220, Inglewood (213) 674-6850; COLO, Denver (303) 934-5505; CONN, Glastonbury (203) 633-0777; FLA, Orlando (305) 894-4401; HAWAII, Honolulu (808) 941-1574; ILL, Des Plaines (312) 298-3600; IND, Indianapolis (317) 244-2456; MASS, Lexington (617) 861-8620; MICH, Detroit (313) 526-8800; MINN, Minneapolis (612) 884-4336; MO, St. Louis (314) 423-1234; N.C, Burlington (919) 227-3639; N.J, Haddonfield (609) 795-1700; N.M., Albuquerque (505) 299-7658; N.Y., E. Syracuse (315) 437-6666, Rochester (716) 328-2230, Vestal (607) 785-9947, Elmont (516) 488-2100; OHIO, Cleveland (216) 261-5440, Dayton (513) 426-5551; PA, Pittsburgh (412) 371-9449; TEX, Houston (713) 688-9971, Richardson (214) 231-2573; VA, Alexandria (703) 354-1222; WASH., Seattle (206) 624-9020; CANADA, Montreal, Quebec (514) 636-0525, Toronto, Ontario (416) 444-9111, Stittsville, Ontario (613) 836-4411, Vancouver, British Columbia (604) 688-2619.

Circle 5 on reader service card

Cool as a
cucumber

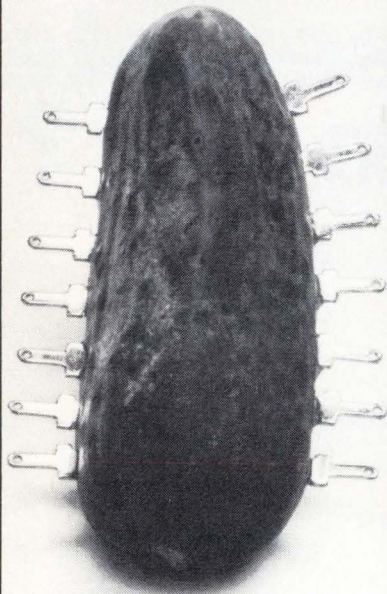

Temperature sensitive hybrids welded with Raytheon DC Welders.

Rectangular or round—weld them fast—and cool—with a Raytheon DC welder... from the widest power range of models available. For more data or a free evaluation of your welding needs—call Tom Daley or Keith Nutter, Raytheon Company, Production Equipment Department, 676 Island Pond Road, Manchester, N.H. 03103. (603) 668-1600.

RAYTHEON

Readers comment

Instrumentation may help music

To the Editor: Reading about technological developments, from the calculator explosion to micro-processor applications and electronic organs, it seems to me there is a large marketing application that has not been developed. As an electronics man and a musician of sorts, I believe there is a market waiting for the developer of an inexpensive series of instruments to help these people. Three applications come to mind:

- A compact audio-frequency counter with built-in microphone, input limiter, LED display, battery-powered, equivalent in size to a hand-held calculator, to indicate precise tuning of a musical instrument or the pitch of any sustained musical tone. For a range from about 100 to 7,000 cycles per second within .01% accuracy, a 3½-digit display with overrange should be sufficient. With suitable sensors, an extended lower range, and inverse period-counting, it could double as a precision tachometer and rate-counter.

- A more elaborate electronic instrument with somewhat wider range could have a predetermined count designed for the particular needs of reed, brass, and nonfretted string instruments. It could also serve as a tuning device, but cater to the problem experienced by those musicians who have to lip or finger their musical instruments into tune while playing, which takes years of practice to do accurately. The ideal electronic instrument would discriminate between adjacent half-tones (accidentals) of the scale; it need not necessarily show a frequency figure, but would merely flash one of a series of lights to indicate when a given note or notes is being played flat or sharp at any moment. The musician, being warned, could then make the adjustment while playing.

- With the advent of lightweight active filters and other techniques, there is a market for an electronic instrument designed for the non-ear musician. There are many who cannot play by ear, have a poor musical

Grayhill brings all PC terminals out one side

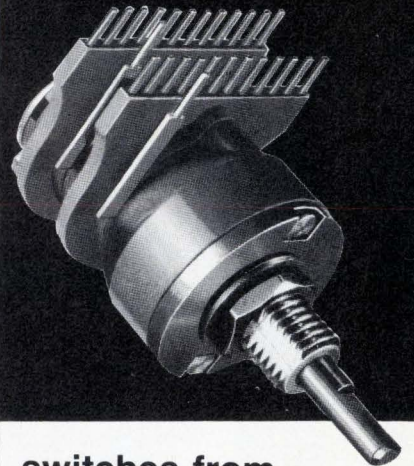

switches from logic levels up to ¼ amp

- ½ inch switches with 10 or 12 positions—1 or 2 poles per deck—1 to 12 decks.
- Designed for wave-soldering process—resists flux contamination
- Enclosed construction at price levels as low as or lower than open wafer switches.

Here's a new Grayhill miniature switch specifically designed for the small loads—and the specialized mounting techniques—of low voltage circuitry. Probably the smallest switch you can find with all PC terminals in the same plane, the switch is surprisingly small in the price dimension too... for enclosed construction and Grayhill quality. For more information on this new member of the Grayhill Series 71 family, write for Bulletin #236... and consult EEM for information on other Grayhill switches.

Grayhill
INC.

661 Hillgrove Avenue • LaGrange, Illinois 60525
(312) 354-1040

A linear gold mine in Silicon Valley

All is not gold that glitters in some linear IC cost/performance claims. At Teledyne's big plant in Silicon Valley we produce only the genuine nuggets—the linears that have passed the test of time.

Teledyne keeps cost low by concentrating on volume production of the most universally applicable types of linears. And you know performance is high because these have proved their worth in thousands of system designs.

Some are extra fine. For example, our 141 op amp gives better slew rate, input bias and offset current performance than does a 107. Likewise, our 142 outperforms the 101A in most applications. And if you don't need the high performance of a 108, our 142 will do the job just fine—at a lot lower price.

And don't worry about your committed system designs caving in. We support your needs with linears stocked in all the popular packages, with unpackaged chips, and with military-grade parts processed to MIL-STD-883.

SILICON VALLEY'S BEST LINEARS

Operational Amplifiers

101A/201A/301A	709/709C
107/207/307	741/741C
108/208/308	141/241/341*
108A/208A/308A	142/242/342*
747/747C	2740*
748/748C	1558/1458/1458C

Dual Timers

D555

Voltage Regulators

104/204/304
105/205/305/305A
376
723/723C
823*
829/829C*
830/830C*

Transistor Arrays

861*

Voltage Comparators

710/710C
711/711C
111/311
3302
139/239/339

*Teledyne proprietary linears

Best of all, you don't have to go prospecting for our linears. You'll find them all at Teledyne distributors. And if you need factory volume and pricing, call a Teledyne rep or come straight to our linear gold mine in Silicon Valley. Either way, you'll strike it rich.

 **TELEDYNE**
SEMICONDUCTOR

1300 Terra Bella Avenue Mountain View, California 94043

(415) 968-9241 TWX: 910-379-6494 Telex: 34-8416

Stop spoon feeding your DIP tester

If you're still hand-feeding your DIP tester for incoming or outgoing inspection, you're working too hard. Put our table-top Model 800 to work. Or any one of our other high-speed, automatic DIP test handlers and you can multiply your DIP test throughput by as much as ten—or more. To get all the profitable particulars write or call IPT Corporation, 1140 W. Evelyn Ave., Sunnyvale, California 94086. Phone (408) 732-7550.



IPT Corporation
High-Speed Automatic Test Handlers

Readers comment

memory, and thus have difficulty in reproducing a melody heard over the air or on records, tape, etc.

These people need an electronic instrument, possibly consisting of a microphone, preamplifier, and wide-bandpass filter driving a set of parallel filters accurately tuned to the standard musical scale, which would indicate the tone pitch with a lamp and the octave at any moment in the composition. The electronic instrument would not be able to discriminate multitone selections played by orchestras or groups—only solo selections. A desirable optional attachment would be a small paper-tape recorder using commonly available adding-machine tape for a permanent recording of the notes as they occur.

Most people can tap their feet to music; thus, a foot-switch or hand-switch, together with an auxiliary beat pen could place beat marks on the tape. The musician could then, from the recording, work out the harmony and key of the composition. This also could be used for tuning with less accuracy, possibly. A recording spectrum analyzer could give a complete analysis, but the price would be prohibitive.

These musical aids could be marketed through department stores and shopping malls, as well as music stores, where they will be exposed to the mass market in North America. There is a latent worldwide demand for such instruments if the price can be kept down.

D. G. MacKenzie
Lethbridge, Alta., Canada

Speaking of languages

To the Editor: We read with interest your article on the PL/M language for Intel microprocessors [*Electronics*, June 27, p. 103]. We would like to point out that the PL/M language is not related to our own microprocessor language, MLP, which is known to readers in the UK, where confusion might therefore arise. MLP is a medium-level, rather than a high-level, language.

D. White, P. Bishop
Central Electricity Research Labs
Leatherhead, Surrey, England

interface- ability

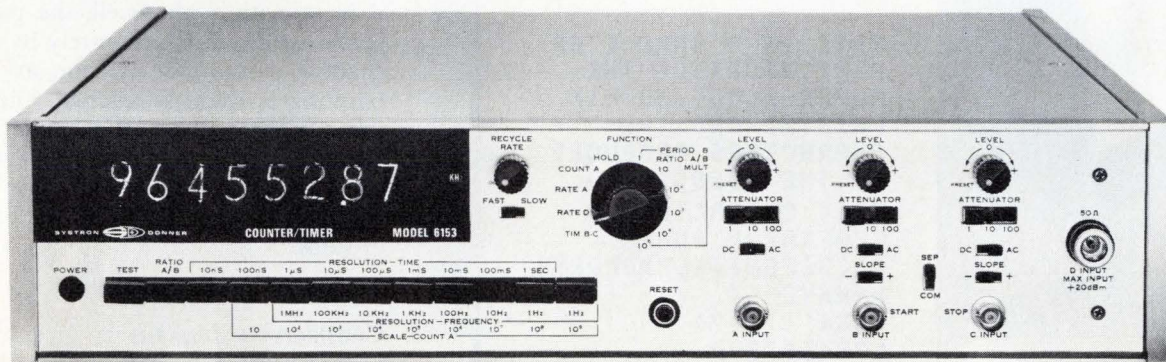
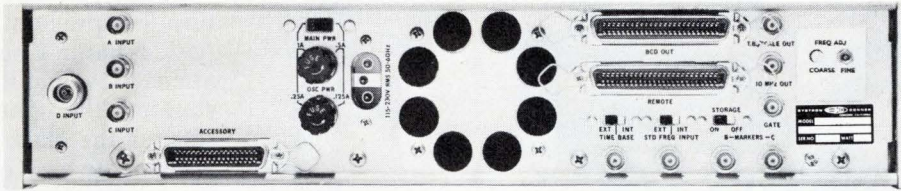

Or why **systems people** buy more S-D counters

- 6 remote **programming** options
- 4 **BCD** outputs (low and high level)
- Special codes, formats, logic levels
- Universal counter/timer functions
- 50, 200, 512 MHz, 3 GHz

For details or a demo on series 6150 counters, call your Scientific Devices sales and service office (listed below). Or contact Concord Instruments Division, 10 Systron Drive, Concord, CA 94518. Phone (415) 682-6161. In **Europe**: Systron-Donner GmbH, Munich, W. Germany; Systron-Donner Ltd., Leamington Spa, U.K.; Systron-Donner S.A. Paris (Le Port Marly) France. **Australia**: Systron-Donner Pty. Ltd., Melbourne.

SYSTRON  DONNER

Albuquerque, (505) 268-6729; Baltimore, (301) 788-6611; Boston, (617) 894-5637; Burlington, NC (919) 228-6279; Chicago, (312) 297-5240; Cleveland, (216) 261-2000; Denver, (303) 573-9466; Dayton, (513) 298-9904; Dallas, (214) 231-8106; Detroit, (313) 363-2282; Ft. Lauderdale, (305) 721-4260; Hamden CT (203) 248-9361; Huntsville, AL (205) 536-1969; Houston, (713) 623-4250; Indianapolis, (317) 783-2111; Kansas City, KS (913) 631-3818; Los Angeles, (213) 641-4800; Minneapolis, (612) 544-1616; New York City area (201) 871-3916; Norfolk, (703) 499-8133; Orlando, (305) 424-7932; Philadelphia, (215) 825-9515; Phoenix, (602) 834-1682; Rochester, NY (716) 334-2445; San Antonio, (512) 694-6251; San Diego, (714) 249-6642; San Francisco area (415) 964-4230; Seattle, (206) 454-0900; St. Louis, (314) 842-2535; Syracuse, (315) 457-7420; Washington, DC area (703) 451-6500.

AMPEREX DOT MATRIX PRINTERS

*Fast, Quiet, Versatile, Low Cost -
And they're a breeze
to integrate into your system!*

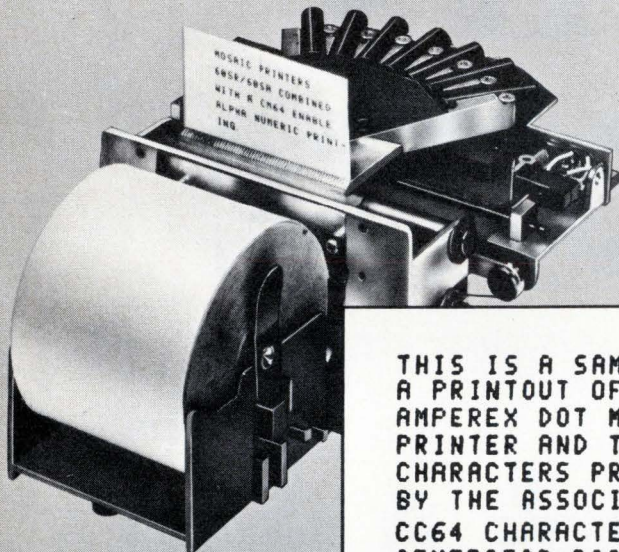

MODEL 60SA

THIS IS A SAMPLE OF
A PRINTOUT OF THE
AMPEREX DOT MATRIX
PRINTER AND THE
CHARACTERS PRODUCED
BY THE ASSOCIATED
CM64 CHARACTER
GENERATOR BOARD.
ABCDEFGHIJKLMNOPQRSTUVWXYZ
UVWXYZ <,./;-:!"#\$
%&'()*+?
1234567890

If you're designing equipment that must print hard copy, Amperex has the Printer for your system.

With an Amperex Printer and the available Amperex Electronics you have all the tools you need to produce at low cost—and on very short notice—high quality medium-speed printout.

Amperex Printers, Models 60SR and 60SA, offer full dot matrix character flexibility and print up to three copies of 20 characters per line data on 2¼ inch paper. Intermittent operation of the (no-clutch) motors guarantees long life, quiet operation and reliability for such applications as POINT OF SALE TERMINALS, PROCESS CONTROL MONITORS, MEDICAL DATA SYSTEMS AND DIGITAL METERS.

OUTSTANDING FEATURES

THE PRINTERS

- LOW POWER CONSUMPTION:
(no standby power; no clutches)
Motors: 8.5 watts; Head: 40 watts
- LONG LIFE:
10 million lines (frame)
- MEDIUM SPEED:
1 20-character line per second
- LIGHT WEIGHT:
only 4.4 pounds
- LOW COST (100 Quantity)
Model 60SR (with ribbon): \$185.
Model 60SA (without ribbon): \$170.

THE ELECTRONICS

- FULL 64 CHARACTER, ASCII FORMAT
- DTL/TTL COMPATIBLE INPUT
- LOW POWER CONSUMPTION:
less than 1 watt
- EASILY INTEGRATED
INTO YOUR SYSTEM
- HEAD SOLENOID DRIVER
- LOW COST (100 Quantity)
Model CM64:
Complete Electronic
Control Package: \$135.

For complete data and information on available applications assistance, write: Amperex Electronic Corporation, Hicksville Division, Hicksville, New York 11802.

Amperex®

TOMORROW'S THINKING IN TODAY'S PRODUCTS

Sold through
North American Philips Electronic Component Corporation

40 years ago

From the pages of Electronics, September 1934

Photocell controls car painting

A valuable use for a photocell has turned up in the spray-painting of automobiles as they go through the production line. In one application, a black paint is applied to the bottom of the cars as they approach the delivery point.

Formerly a man was employed to turn the spray on and off as the car passed, but in a number of cases the attendant would forget or neglect to shut off the spray promptly, and some of the black lacquer would go up over the back of the car, spoiling the paint and requiring refinishing.

Now, with a photocell, the paint spray is turned on accurately by the shadow of the car, as soon as the painting position is reached, and is turned off equally sharply as soon as the car passes, automatically preventing possibility of getting the black under-body paint on the back or sides.

A simple facsimile printer

Considerable impetus is given the coming of "home-facsimile" through ordinary home radio sets, by a new direct printing process using standard carbon paper and requiring no processing—other than to be picked up and read!

The paper to be printed on, accompanied by a piece of carbon paper, passes between a revolving roller and an oscillating knife-edge. Around the roller is embossed a raised spiral of a single turn. This roller and spiral revolve once during the time the paper is being advanced the width of one line of the facsimile.

Thus, if the straight-edge knife is pressed continuously against the roller, the point of contact with the spiral will run across the paper and a solid horizontal line will be drawn across the page.

If, however, the knife-edge is raised and lowered by the reproducer magnet, dots and dashes of the picture will be reproduced. The carbon paper is used over and over, and is the only part needing eventual replacement.

The 25S09.

A remarkable new shift register,
more or less.

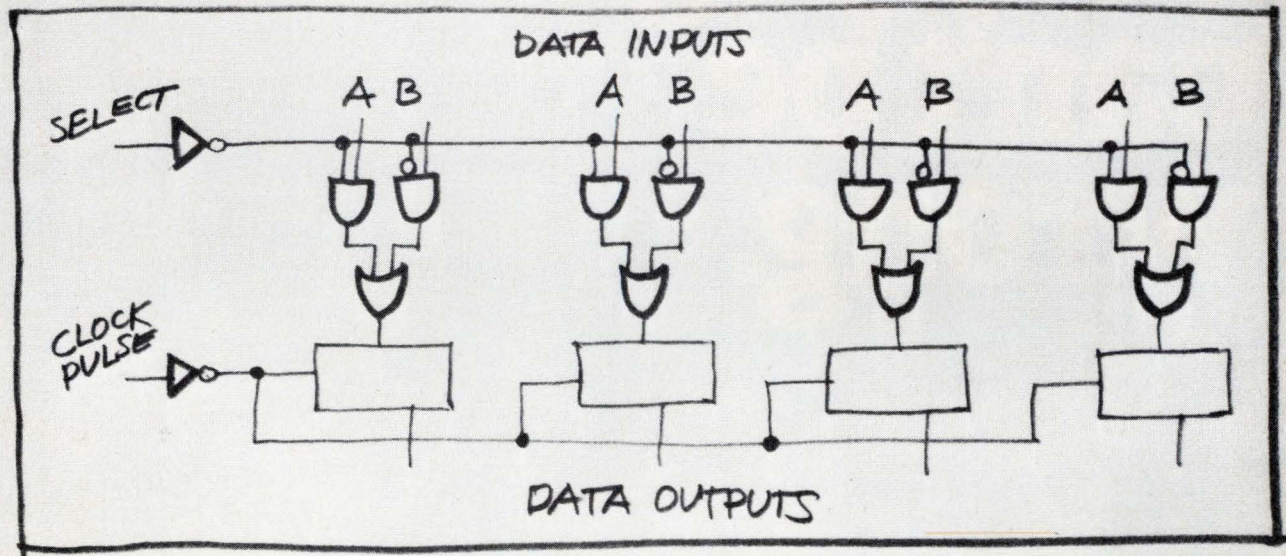

Now there's twice as good a way to do the 74S158/74S175 job. All it takes is one high-speed register: the Am25S09.

More: Speed. It's 24% faster. System applications. It has a positive edge trigger. It's Schottky.

Less: Space. One package instead of two. Power. It takes 24% less.

And here's everyone who makes it:

74S158

74S175

working together to perform this function

25S09

doing the same function as the two units above

SAVINGS

or in percentages

Speed

6 ns

17ns

23ns

17.5ns

5.5ns

24%

Power

320mW

504mW

824mW

630mW

194mW

24%

Advanced Micro Devices

Corporate offices are at 901 Thompson Place, Sunnyvale, California 94086. Telephone (408) 732-2400 or toll free from outside California (800) 538-7904/Southern California office: Beverly Hills (213) 278-9700/Mid-America: Oak Brook, Illinois (312) 323-9600/Edina, Minnesota (612) 835-4445/Eastern United States: Roslyn Heights, New York (516) 484-4990/6806 Newbrook Ave., E. Syracuse, New York (315) 437-7546/Baltimore, Maryland (301) 744-8233/Lexington, Massachusetts (617) 861-0606/Britain: Advanced Micro Devices, Telephone Maidstone 52004/West Germany: Advanced Micro Devices, Munich, Telephone (089) 53 95 88. Southern Europe: Advanced Micro Devices, S.A., Neuilly, France, Telephone: 747-4194. Distributed nationally by Hamilton/Avnet, Cramer and Schweber Electronics.

20 million LED digits can't be wrong.

Litronix DL-707 0.3" high digit has same superior features as DL-747 below.

Litronix DL-747 has 0.6" high digits 44% larger in area than digits from any other major supplier.

Mitered corners increase eye appeal.

Light pipe spreads illumination evenly.

Mounted on DIP with standard pin spacing.

DL-747 with cap in place over light pipes.

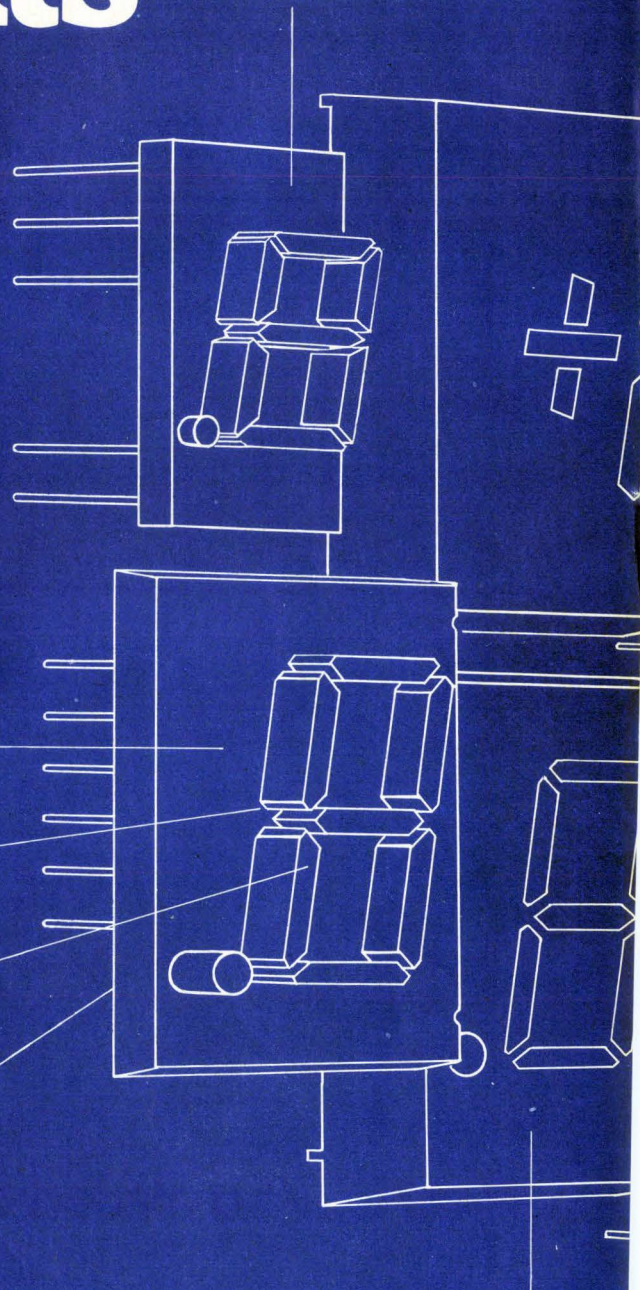

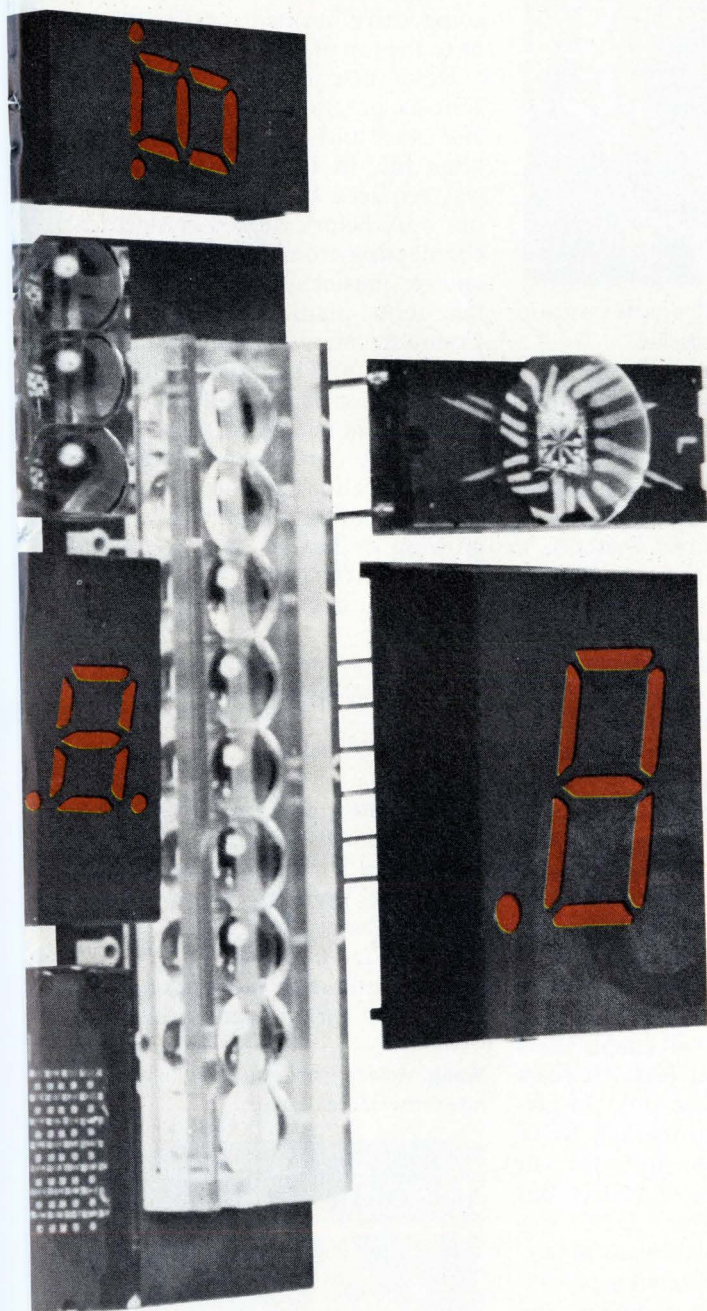

You'll find major advantages in dealing with the world's largest supplier of LEDs—the one that's shipped over 20 million LED digits to date and will deliver many millions more in 1974.

For openers, the Litronix product line is so broad that you can get exactly what you need. Sizes from 0.1" to 0.6". Colors like red and orange today, with yellow and green in volume production soon. Common anode or common cathode. And polarity overflow digits in many sizes.

Perhaps even more important, you're assured of a consistent, reliable product. Litronix doesn't buy any high-technology parts from others. We make everything in-house—starting with the basic GaAsP materials. The result is that we have better overall control: high brightness, proven reliability and assured delivery.

Litronix has two plants in the U.S. and three more overseas to keep the LEDs flowing. Because our volume is large, our prices are very, very competitive.

The drawing at left of our big 0.6"-high DL-747 shows some of the superior characteristics of the popular Litronix 700 Series displays.

Contact us right now for LED displays, LED lamps, opto-isolators, or phototransistors. We know we can meet your needs. Like we say, over 20 million LED digits can't be wrong.

Litronix, Inc., 19000 Homestead Road, Cupertino, CA 95014. Phone (408) 257-7910. TWX 910-338-0022.

**No wonder
we're No.1
in LEDs**

litronix

Circle 13 on reader service card

MORE POWER MORE BANDWIDTH

Our Model 503L is an ultra-wideband RF power amplifier whose wide range of frequency coverage and power output provides the user with the ultimate in flexibility and versatility in a laboratory instrument. Easily mated with any signal generator, this completely solid state unit amplifies AM, FM, SSB, TV, pulse and other complex modulations with minimum distortion.

Constant forward power is continuously available regardless of the output load impedance match, making the 503L ideal for driving highly reactive loads.

Unconditional stability and instantaneous failsafe provisions in the unit provide absolute protection from damage due to transients and overloads.

This low cost instrument, covers the frequency range of 1.6 to 540 MHz with a linear power output of 3 watts . . . and there's no tuning. Priced at \$995.*

Applications include:

- Laboratory instrumentation
- Communication systems
- Laser modulation
- RFI/EMI testing
- Spectroscopy

*USA and Canada



For further information or a demonstration contact

ENI, 3000 Winton Road South,
Rochester, New York, 14623.

Call 716-473-6900.

Or TELEX 97-8283 ENI ROC.

ENI

The world's leader
in solid-state power amplifiers.

People

For Davis, the growth
is in data communications



Planning. Davis wanted the name change to put things in proper perspective.

The first thing Jack C. Davis wanted for Communications Systems Inc., when he took over in April as operating chief, was a change of name. He got what he wanted this month when Communications Systems, a Dallas-based division of Harris Corp., officially became Harris Data Communications division.

"After all," notes the 36-year-old Davis, "all of Harris is in the communications-systems business—from printing presses to satellite communications; data communications just describes more specifically the segment we're responsible for."

This month was eventful in more ways than one for the newly named Harris division. It turned out its first new product since Davis took over—a powerful remote communications processor based on a minicomputer. Davis says the unit will enable users to build on it for at least 10 years [*Electronics*, Sept. 5, p. 25]. "In getting that product to market, we've had to make major management changes—not typical of Harris, but necessary in this case." Davis was referring to the replacement of several hold-over managers by personnel from the parent company and elsewhere.

When pressed, the boyish-looking Davis acknowledges that he was brought in because of his track record elsewhere at Harris. At Har-

ris Controls division in Melbourne, Fla.—a builder of computer-control equipment—sales volume and earning grew almost three-fold during his 20-month tenure as vice president and general manager. Davis appears almost nonchalant about the achievement: "We simply brought new products to a highly competitive business, and that took us to the top of the market."

Davis first joined Harris after a stint as program manager for several space and military jobs at Radiation Inc. In 1962, Radiation itself was acquired by Harris. Davis who has a bachelor's degree in electrical engineering from Mississippi State, and a master's from UCLA, says long-term plans for Harris Data Communications are being formulated now. And he indicates the general direction in which the division's energies will be applied. "We expect to improve our over-all image as a communications-systems supplier," he says, adding that, "in a field growing as fast as data communications, you've got to build in lots of growth just to keep up."

Victor's Wang looks
to the high end

Unlike the high-technology newcomers that are contending among themselves for the low end of the calculator market, Victor Comp-tometer Corp. is firm about concentrating on the high end. To keep Victor competitive in the market it has dominated for 55 years, Edward D.

Wang. Victor's marketing know-how should help technical calculators.



What's going in... in mainframes?

MOSTEK's 16-pin 4K RAM.

Your mainframe memory system... MOSTEK's 16-pin 4K RAM. A perfect match. Because MOSTEK's 4K RAM gives you the performance, board density and ease of use your system demands. Plus it's available *now*.

Compare performance at the system level. MOSTEK's low capacitance, TTL compatible clocks, combined with superior output drive capability, provide the access time your system requires. Alternate 22-pin designs require high capacitance clocks and additional output buffering, causing system speeds to be lower. MOSTEK's 16-pin multiplexed design reduces the number

of address buffers required without affecting high speed access time. For small peripheral memory arrays the cost savings are substantial—even more so in the case of large mainframe arrays. So look to MOSTEK to meet the high speed requirements of your system.

Want board density? Of course. All memory users—from peripheral and minicomputer manufacturers to the big mainframe people—appreciate the increased density offered by MOSTEK's 16-pin design. (A 50% savings in memory board size over 22-pin alternates.) The result is a more compact, cost effective system.

Interested in ease of use? Again, compare the advantages of MOSTEK's MK4096. Readily available automatic insertion equipment can be used in

board assembly. Voltage pins are on the corners to simplify PCB layout. All inputs including clocks are directly TTL compatible with low capacitance. And the circuit is extremely tolerant of noisy system environments.

Your mainframe, minicomputer or peripheral memory and MOSTEK's 4K RAM. That's what's *going in*.

Want more details? Call your local MOSTEK distributor or representative or contact MOSTEK, 1215 West Crosby Road, Carrollton, Texas 75006, (214) 242-0444. In Europe contact MOSTEK GmbH, TALSTR. 172, 7024 Bernhausen, West Germany, Tel. 798038.

MOSTEK®

Circle 15 on reader service card
MOSTEK moves forward...in memories.

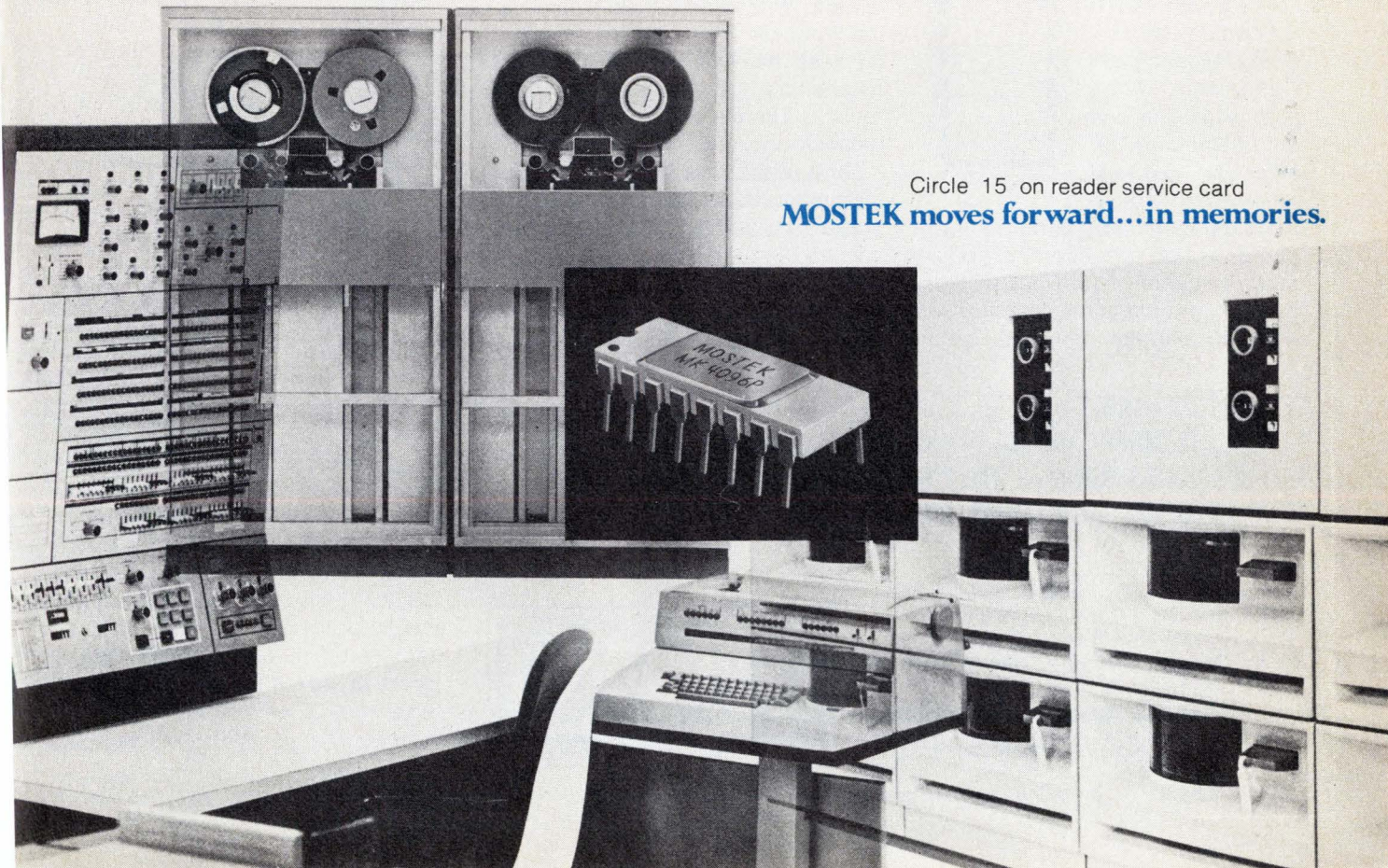

CIRCUIT DESIGNERS...

GET MORE VERSATILITY AND FLEXIBILITY IN YOUR BREADBOARDING.

Experience the convenience of **MULTI-COMP[®]** **DIP Multiple-Section** **Ceramic Capacitors**

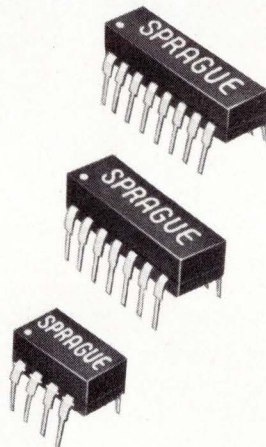

Breadboarding is a lot easier with Sprague Multi-Comp Monolythic[®] Ceramics. They readily plug in and out of standard DIP sockets for fast changes during experimentation. They come as 4-, 7-, and 8-section capacitors, in popular most-frequently-used capacitance values. By connecting capacitor sections in parallel, you can obtain

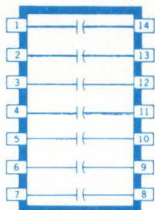

practically any value your circuit needs. With a few Multi-Comp capacitors on hand, there's no need to keep heavy stocks of individual capacitors for breadboarding purposes. There's less soldering and unsoldering, too.

And when your final capacitance determinations are made, you can either stay with DIP Multi-Comps, or switch to Sprague Single-Section Monolythic[®] Capacitors, which have the same layer-built construction and the same electrical characteristics.

**GET THE DIP HABIT —
TRY MULTI-COMP[®] MONOLYTHIC[®] CAPACITORS IN YOUR NEXT
BREADBOARD DESIGN — THEY'RE READILY AVAILABLE FROM
YOUR SPRAGUE INDUSTRIAL DISTRIBUTOR!**

For more information, write or call
Ed Geissler, Mgr., Specialty Components
Marketing, Sprague Electric Company,
35 Marshall Street, North Adams, Mass. 01247.
Tel. 413/664-4411.



THE BROAD-LINE PRODUCER OF ELECTRONIC PARTS

16 Circle 16 on reader service card

People

Wang, new president of the Chicago company's Business Products group, intends to make full use of the strong dealer network and service organization he has inherited.

"As soon as you pass the \$300 to \$400 barrier, the machine has got to be marketed in order to be sold," the tall, soft-spoken Wang notes. "As calculators get higher-priced, the marketing value added becomes more important than the manufacturing value added."

Under Wang's guidance, Victor will be involved in all segments of the technical-calculator business, with both programable solid-state machines and those designed to serve specific markets. Earlier this year, for example, Victor started shipping what Wang says is the industry's least expensive line—from \$995 to \$1,995—of programable printing calculators for business applications, and it is now looking at dedicated machines for statistics, engineering, financial, retailing, and manufacturing markets.

Surprisingly, perhaps, Wang intends to keep Victor turning out electromechanical calculating machines as long as sales hold up. The number of units sold has not changed in the past year, he notes.

A Shanghai native, Wang has spent most of his 40 years in the United States. After earning mechanical engineering and business degrees from Syracuse University, he held planning posts at Olivetti Corp. of America and SCM Corp., both of New York, N.Y. Most recently, he served as president of Victor's Computer division, sold a short while ago to West Germany's Nixdorf Corp.

Wang is not turning his back entirely on the market in cheap personal calculators, however. Victor has just started delivering a \$49.95 four-function model. "We want to maintain a low profile in the hand-held market for a while, at least," Wang comments. "We're optimistic, but we're also concerned about the terrific price deterioration." And he adds that "lots of the people cutting prices now won't be in the business in the next 12 or 18 months."

Circle 17 on reader service card →

A 5-digit multimeter at a 3-digit price.

\$995. That's the basic price of the 5000. And that's the lowest price we've ever had for a 5-digit multimeter.

\$375 adds true RMS.

This converter can measure signals with crest factors ranging up to 22. All with typically 0.1% accuracy and settling times of less than 600 milliseconds. AC or AC+DC mode operation is also provided.

When you consider the

5000's total performance, there's really nothing comparable for the money. You get delayed dual slope integration for increased accuracy and linearity at a reduced cost, 100% over-ranging and autoranging to ensure complete flexibility in use. And a large LED display with leading zero blanking for easy viewing.

The 5000 is truly a classic technical achievement. Improved performance at lower cost.

Contact your Dana sales representative by calling toll-free 800-645-9200. In New York, phone 516-294-0990. In Europe, call 02-241 4550.



DANA®

Others measure by us.

It's so accurate, no other 5-digit multimeter can check its performance.

In order to check the readings of our 5900, you'll need a more accurate 5-digit multimeter. And no such instrument exists.

Because of its high stability, there is a minimum of recalibrations to ensure its .001% accuracy.

That's impressive enough. But the 5900 has a lot more going for it.

It provides true systems capability. The standard digital output and optional remote programming in

every 5900 are fully isolated and buffered. More than 20 readings per second can be made on all measurements. And there is a super-fast mode that allows 100 readings per second.

It has 5 DC ranges, 60% over-range and full ratio capability. Plus 350 volts RMS protection on all ohms measurements. Now it even has a true RMS converter.

The basic 5900 price is \$1,995. And at that price, nothing else is really comparable.

Contact your Dana sales representative by calling toll-free 800-645-9200. In New York, phone 516-294-0990. In Europe, phone 02-241 4550.



DANA®

Others measure by us.

CERAMIC
AIR
GLASS
QUARTZ
PLASTIC

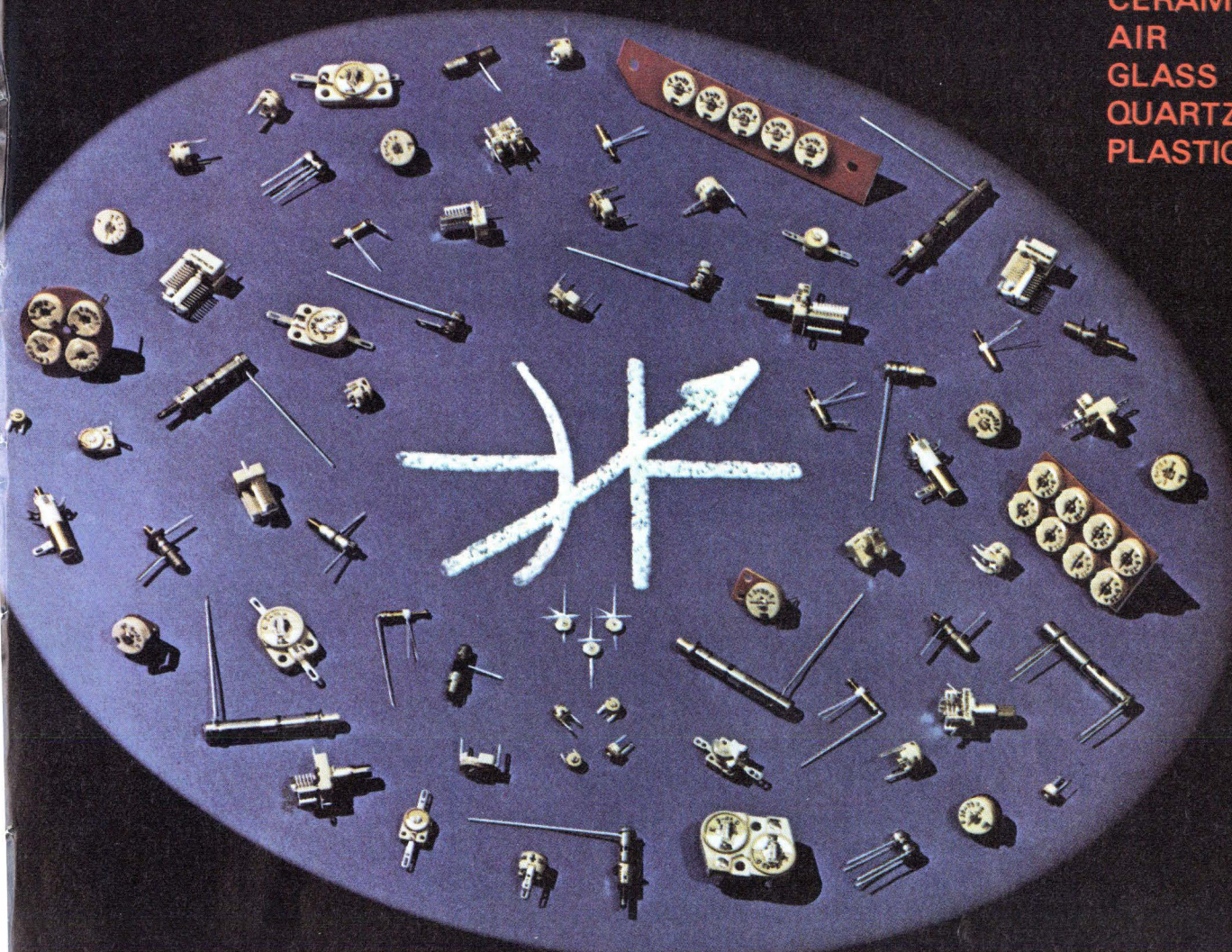

THE TRIMMER CAPACITOR YOU NEED APPEARS SOMEWHERE IN THIS SPOTLIGHT

**MORE THAN 1,000 VARIATIONS TO CHOOSE
FROM... AND ERIE DELIVERS ON TIME**

When engineering and purchasing people need Trimmer Capacitors, most look to ERIE first. And for good reason. It's easy to find the trimmers they need. The price is right... the quality is typically ERIE... and they know ERIE delivers on time to meet production schedules.

ERIE Trimmer Capacitors range in size from the tiny new "Vari-Thin" 515 Ceramic Trimmer for quartz watches and other miniature circuits... up to a variety of larger sizes and assemblies. Whether you need ceramic, air, glass, quartz or plastic, we have the dielectric, capacitance range and mounting arrangement to meet your requirements. If you have the application... ERIE has the Trimmer Capacitor. In the spotlight above, can you find the Trimmer best suited to your current bread-board circuit?

Let ERIE serve as your one-stop source for quality Trimmer Capacitors.

WRITE TODAY FOR OUR
TRIMMER CAPACITOR
CATALOG... 500
OR CALL 814/453-5611

ERIE TECHNOLOGICAL PRODUCTS, INC.
Erie, Pennsylvania 16512

ERIE

From design microcomputers in

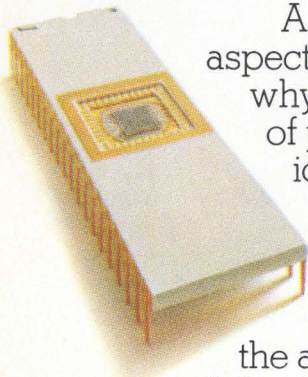

A new Intel report on the monetary aspects of microcomputers explains why the profitability of thousands of products has risen so dramatically since Intel began supplying the electronics industry with micro computers three years ago.

The report is yours for the asking, whether your responsibility is product development, production management, marketing, or preparing the company P&L statements. Our discussions with many equipment manufacturers confirmed that microcomputers often have company wide economic impact.

The interviews frequently revealed that Intel microcomputers helped product development staffs cut six to twelve months from development cycles and save more

than 30 percent in engineering and documentation costs. Microcomputer based products can generally be defined more quickly than those built with discrete logic or custom LSI. Also special control and processing options can be added at small incremental costs.

Engineering time shrinks because microcomputers provide the designer with an LSI logic structure that attains great flexibility through software. In fact, the engineer designs through programming, a much faster procedure than working through logic diagrams. Supporting design and documentation tasks often

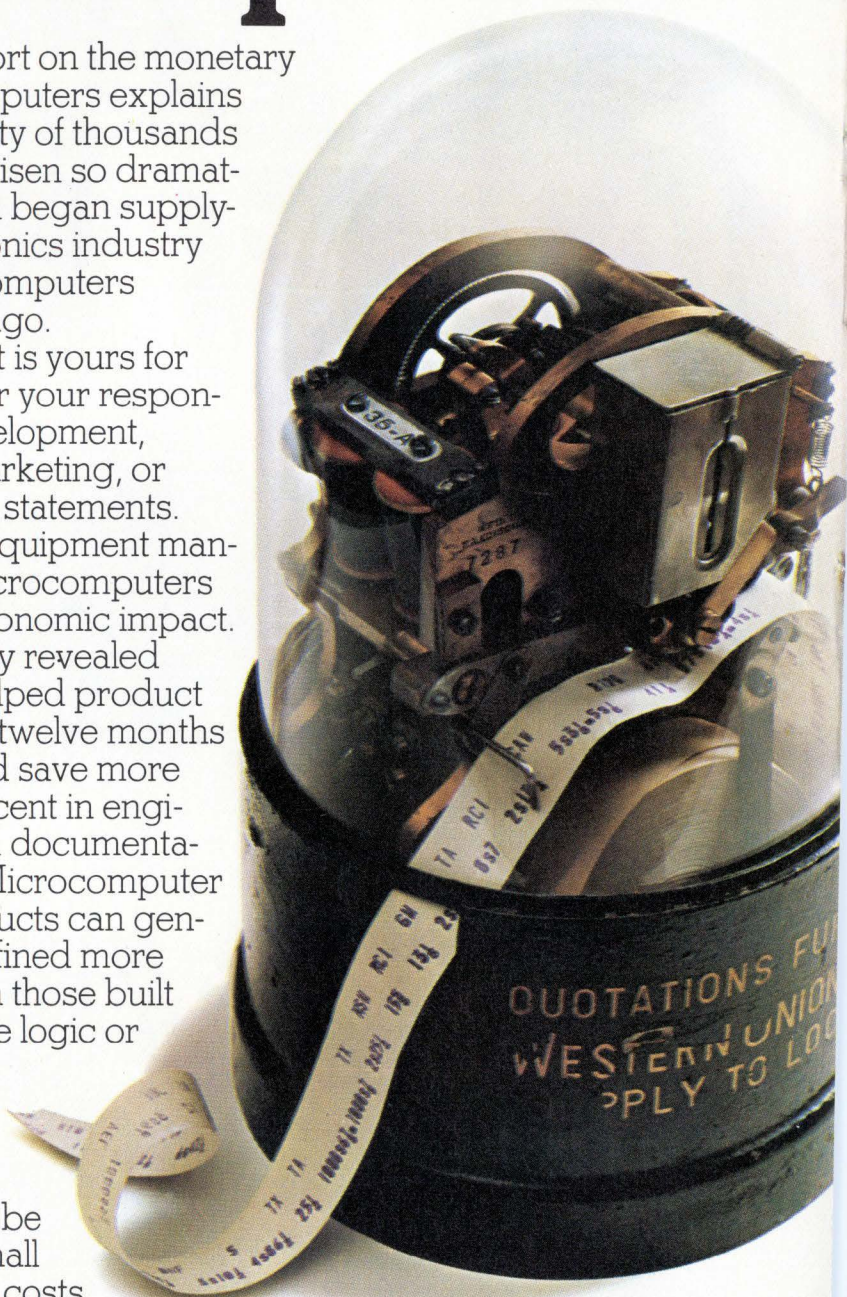
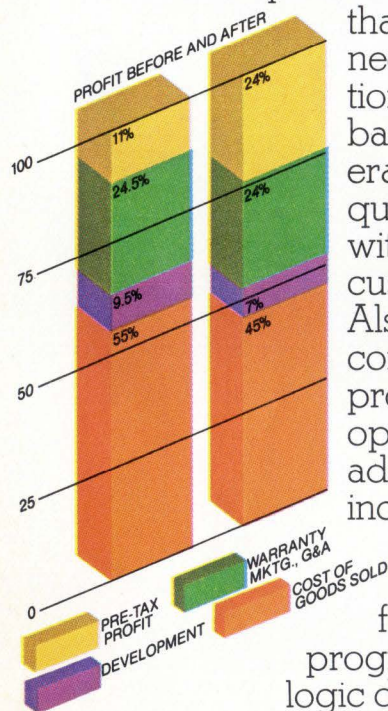

to market, Intel crease your profits.



become trivial. And simple changes in software generally replace major revisions in hardware and documentation.

Microcomputers also reduce manufacturing costs. Estimates of savings in circuits, hardware and assembly costs usually fall in the 20 to 50 percent range. It is possible to displace hundreds or even thousands of TTL packages, for example, with an Intel microcomputer system. Even a small one, costing less than \$100, displaces \$150 to \$600 of TTL

assemblies. And since simpler systems are more reliable, field service costs drop.

Furthermore, a shorter development cycle gives marketing an opportunity to introduce a new product faster than the competition and win a larger market share. This can generate much higher sales income for a longer period of time.

Another bonus accrues from the small incremental costs of programmable special features. End users often request computation or control options with a market value 10 to 20 times higher than the cost of adding the additional program storage to the basic model. In fact, a marginal product line can be made profitable by redeveloping it around a microcomputer and offering attractive new options. And the line's market life may be extended further with enhancements added as new programs.

The net effect of all these advantages can be a 10 to 20 percent rise in the overall profitability of a product line.

But you owe it to your company to get all the details of how microcomputers can give your products higher profitability from design to market. Read "Microcomputers—What They Mean To Your Company." It's yours for the asking from Intel, the company that supplies the most microcomputers to equipment manufacturers.

Intel Corporation, 3065 Bowers Avenue, Santa Clara, California 95051, (408) 246-7501.



intel® Microcomputers. First from the beginning.

FLAT INTERCONNECTS YOUR COMPLETE SOURCE

Ribbon Cable / IC Interconnects / Custom Harnesses

You're sold on flat cable, now buy it at its best. Precise, compact cable packages to fit your specifications perfectly, computer-loomed for unmatched versatility by Woven Electronics.

Handling ease of independent non-bonded leads speeds production, cuts cost, while technical characteristics outrank other flat cable forms.

Make Woven your source for jumpers, continuous rolls, special harnesses, all your interconnect needs.

WOVEN ELECTRONICS

P.O. Box 189 Mauldin, South Carolina 29622
803/963-5131

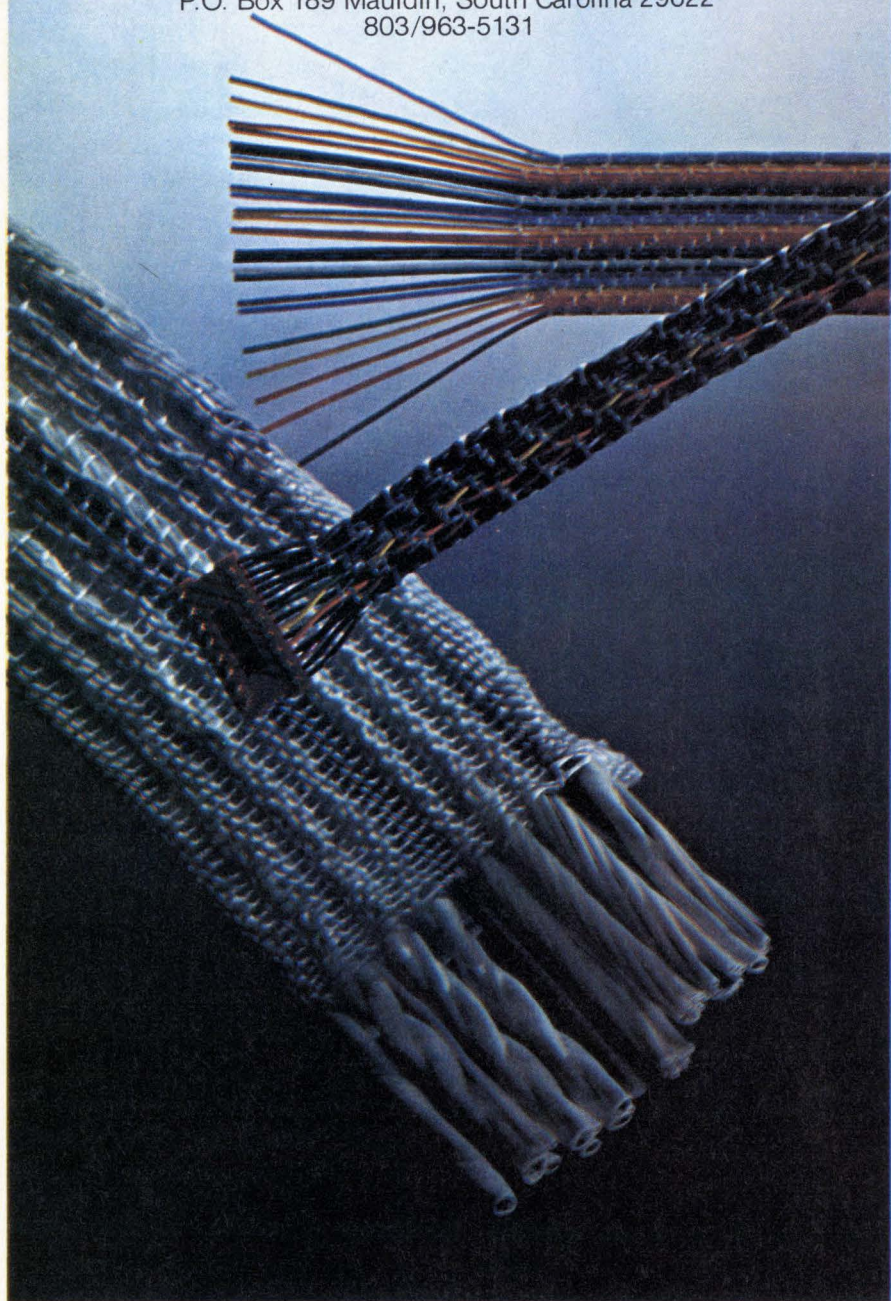

Meetings

International Broadcasting Convention, IEEE et al., Grosvenor House, London, Sept. 23-27.

International Conference on the Technology and Applications of Charge-Coupled Devices, University of Edinburgh, Centre for Industrial Consultancy and Liaison, et al., Edinburgh, Sept. 25-27.

Semicon East '74, Semiconductor Equipment and Materials Institute (San Mateo, Calif.), Nassau County Coliseum, Uniondale, N.Y., Oct. 1-3.

Eascon '74, Electronics and Aerospace Systems Conference, IEEE, Marriott Twin Bridges Motor Hotel, Washington, D.C., Oct. 7-9.

IAS '74, IEEE Industry Applications Society, William Penn Hotel, Pittsburgh, Oct. 7-10.

Tenth Annual International Telemetry Conference, EIA et al., International Hotel, Los Angeles, Oct. 15-17.

National Electronics Conference, sponsored by the National Electronics Conference Inc. (Oak Brook, Ill.), Hyatt Regency O'Hare Hotel, Chicago, Oct. 16-18.

1974 Symposium of the International Society for Hybrid Microelectronics, (Montgomery, Ala.), Sheraton-Boston Hotel, Boston, Oct. 21-23.

ISA Conference and Exhibit, Instrument Society of America (Pittsburgh, Pa.), New York Sheraton Hotel and New York Coliseum, Oct. 28-31.

Nerem-74, Northeast Electronics Research and Engineering Meeting, IEEE, Sheraton-Boston Hotel and John B. Hynes Veterans Auditorium, Boston, Oct. 29-31.

International Symposium on Information Theory, IEEE, Notre Dame, Ind., Oct. 27-31.

When "off the shelf" won't do, call us!

If you're talking precision pots, then talk to Duncan. For the past 15 years, Duncan's crack engineering team has designed literally thousands of 'specials.' We're proud to have some of the nation's finest technical minds to help solve your engineering problems. And a short step away is Duncan's modern production and testing facilities. Since 'specials' are a major part of our regular business, you'll be equally impressed by our competitive prices and unusually quick delivery schedules.

Duncan is keeping up and ahead of our times to meet

your growing requirements for better more reliable products; including non-wirewound Resolon® Conductive Plastic elements and single-turn or multi-turn precision wirewound pots, both available with linear or non-linear functions. Call us for design assistance or write today for technical literature.



DUNCAN ELECTRONICS

SUBSIDIARY

SYSTRON  **DONNER**

2865 Fairview Road • Costa Mesa, California 92626
PHONE: (714) 545-8261 □ TWX 910-595-1128



**Duncan: Your prime source for
custom designed pots.**

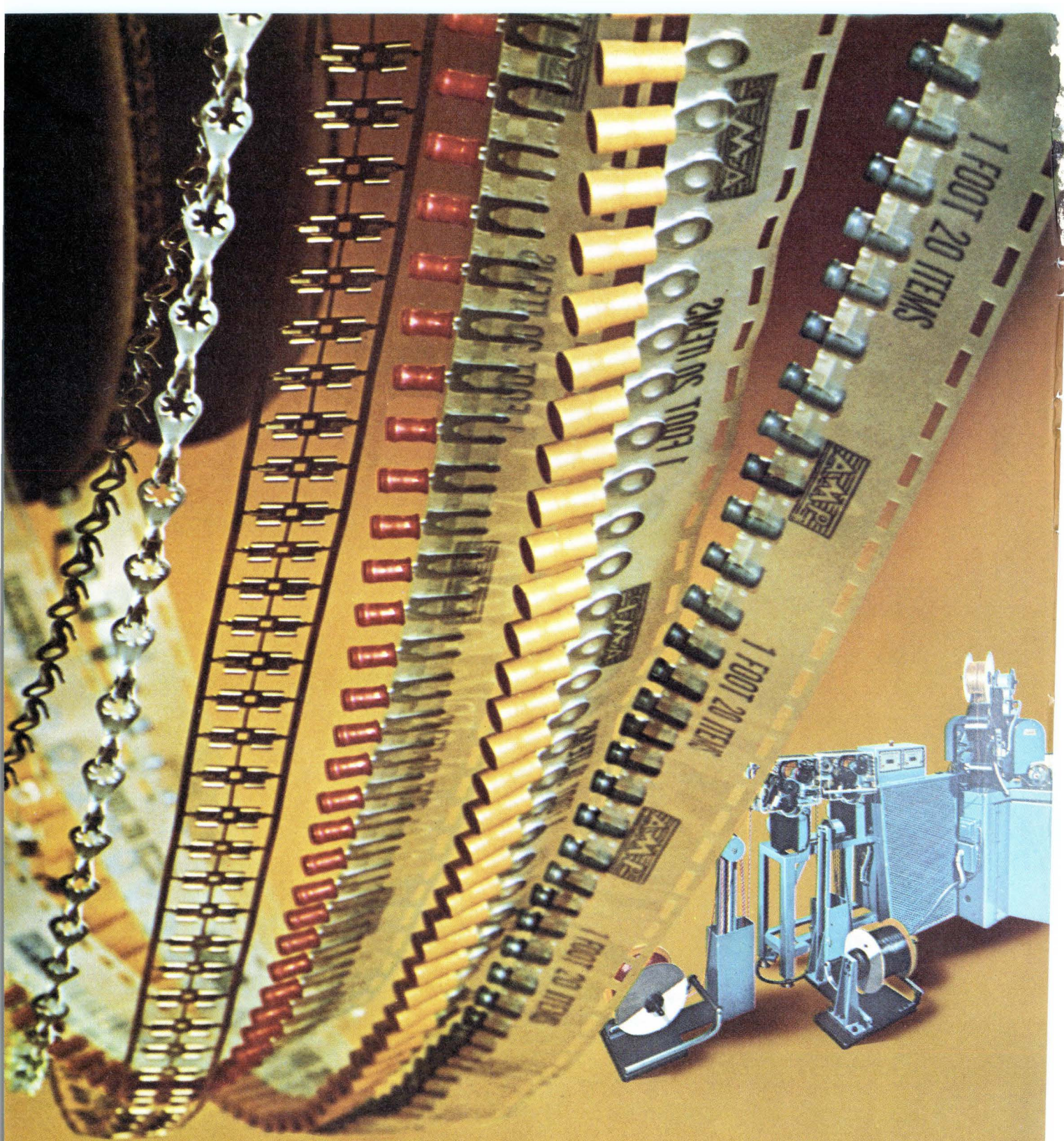

AMP, more than ever, helps you

Applied costs. The costs that really count. AMP helps you keep them down several ways. Not only with more innovative terminals and terminating equipment. But with thousands of dependable types—proven in the field. A wide variety of tongue shapes. For stranded or solid wire—copper or aluminum—in a wide range of sizes. For thousands of different applications.

But most important is the AMP capability to offer a full range of application equipment—manual, semiautomatic or automatic—that assures consistent performance, termination after termination. And results in low applied cost for you.

Reliability of the machinery—and of service—is as important as reliability of the products. AMP equipment is built for long service life. AMP knows you can't afford downtime, and we keep you in production every possible way. Including over a thousand sales and service personnel in the field. And over a hundred locations to serve you. When you deal with the leader, that's the kind of support you can expect. And get.

Let us help you with your present and future requirements. You'll quickly discover for yourself why AMP stays #1. Call (717) 564-0100, circle the Reader Service Number, or write AMP Incorporated, Harrisburg, PA 17105.

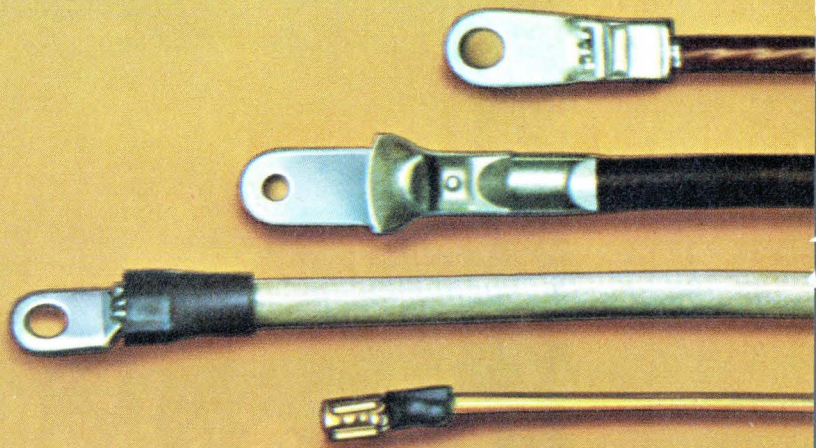

Keep production costs down.

AMP
INCORPORATED

Circle 25 on reader service card



New
space
saving
additions
to our
line
of 1/2" diameter
variable
resistors.

If you're really
serious about cost,
be serious about quality.

Our 1/2" diameter variable resistors help you fight panel congestion. Type WR (lug terminals on side of case) and Type WRS (WR with rear mounted SPST switch). Both types give you famous Allen-Bradley hot molded composition resistance tracks for dependable, long term perform-

ance. Power rating 0.5 watt at 70°C. Linear taper available in values from 100 ohms to 5 megs. Four other standard tapers available from 500 ohms to 2.5 megs. Tolerance $\pm 20\%$ or $\pm 10\%$. Request specifications publication 5220. Contact your Allen-Bradley Electronic Distributor or

write Allen-Bradley Electronics Division, 1201 South Second Street, Milwaukee, Wisconsin 53204. Export: Bloomfield, New Jersey 07003. Canada: Allen-Bradley Canada Limited, Cambridge, Ontario. United Kingdom: Jarrow, Co..Durham NE32 3EN.

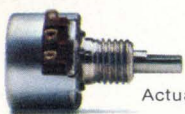

Actual Size

Circle 26 on reader service card



ALLEN-BRADLEY

Milwaukee, Wisconsin 53204

Probe isolates wired-OR faults

A testing problem long regarded as incapable of solution has been solved. Now it can be determined, without removing the IC from a printed-circuit board, which of the outputs of an IC connected in a wired-OR configuration is bad, according to Roger Boatman, president of Testline Instruments, Titusville, Fla. His company has developed a wired-OR probe **that detects bad outputs by means of a strobed current detector.**

The \$350 accessory to Testline's line of automated in-circuit testers is based upon the principle that an output bus cannot be held low unless something connected to it is sinking current when it shouldn't. To find the bad output, the probe's gated detector looks to see which node is experiencing a sudden change in current after the output bus has been driven high for a short time by a very narrow current pulse.

The only system thus far delivered is now being evaluated at Xerox Corp.'s El Segundo, Calif., manufacturing facility. There, John D. Moore, manager of test engineering, says it **has successfully located wired-OR faults** that previously would have had to be found by removing suspect ICs from the board—a method that could destroy a board.

Resistor varies linearly with temperature

The Electronic Products division of Corning Glass Works in Bradford, Pa., will soon be selling a nickel-film temperature-sensitive resistor whose resistance varies linearly with temperature. The device's resistance characteristic remains linear over an extremely broad operating temperature range—from -20°C to $+150^{\circ}\text{C}$. **This linear operation is unique for a temperature-sensitive device,** asserts Michael Teders, a market analyst at Corning. Other temperature-sensing devices, like thermistors and wirewound resistors, are usable only over a limited temperature range, he points out.

Corning expects its new devices, which have a nominal resistance value of 1,000 ohms (at 25°C) and tolerances of $\pm 1\%$ or $\pm 5\%$, to be used in automotive, appliance, and circuit-compensation applications.

Specialized carriers move toward joint ventures

An agreement with Western Telecommunications Corp. of Denver, will give MCI Telecommunications Corp. a coast-to-coast network without completing construction of its own system. This is the latest in a series of mergers and joint operating agreements into which **inflation, high interest rates, and a shortage of investment capital have driven the specialized common carriers.** Claiming annual billings nearing \$5 million, MCI is one of the largest of the carriers attempting to compete with AT&T on a national scale for a share in the \$1 billion business communications market (see p. 40). Western Telecommunications serves Los Angeles, San Francisco, San Diego, Phoenix, and Tucson, while MCI's linkage of 20 cities in the East and Midwest is now stalled at Albuquerque, N.M., by a creditors' freeze on construction funds. Before MCI can use the other company's facilities, however, it must gain the Federal Communications Commission's approval of the agreement and then build a 350-mile link between the two systems, which will cost \$1 million to \$2.5 million.

MCI's action follows Datran Corp.'s agreement with Southern Pacific

Communications Co. in August to share services, and MCI's own merger in November 1973 with N-Triple-C Inc., a Midwest regional carrier. Industry sources observe that the current financial situation also spells trouble for electronics companies counting on new customers for digital-communications equipment.

Biggest computer scheduled in '78 for Baltimore

Congress will soon review a proposal by the Social Security Administration to construct and equip what it calls "the largest nonmilitary computer system in the world" outside Baltimore. To be operational by 1978, this will become the main computer center for welfare, Social Security, and Medicare-Medicaid programs. **Some equipment will be purchased, some will be leased, and older hardware will be traded in** for newer equipment if and when the facility is approved and constructed. Cost of building the computer center, complete with extensive computer-security precautions, including electronic access controls, will be more than \$68 million, the agency says.

National aims to sell 4-k RAM by spring

Look for National Semiconductor Corp. to have its 4,096-bit random-access memory on the market by spring because "the whole world will be changing over to that part in 12 to 18 months," says Jerry Larkin, marketing manager for advanced products (see p. 76). National plans to build a part compatible with Texas Instruments' 22-pin 4030 [*Electronics*, April 18, p. 25], **but hopes to get the 300-nanosecond TI model into the 200-ns region.** The speed improvement is one of the reasons National decided against building a device in the Mostek 16-pin image—the firm's engineers didn't believe the Mostek design could be pushed that far.

Raytheon halts work on its microprocessor

Ostensibly because of the current slowdown in the industry, Raytheon Semiconductor has suspended its microprocessor effort for at least three months—but **if past performance is a barometer, the suspension might last longer.** Company officials say the decision to stop work on the RP-16, a bipolar microprocessor utilizing Raytheon's V-ATE LSI process, was a matter of economics and emphasis. But Raytheon has been trying to get its 1,024-bit RAM from pilot line to production for two years. As a result, industry observers suspect there is more wrong with the firm's LSI than economics.

Addenda

The new general manager of the IEEE is Army Major General Herbert A. Schulke, currently **director of communication electronics for the Joint Chiefs of Staff.** Schulke, a graduate of West Point and the University of Illinois, will take over Jan. 1, succeeding Donald G. Fink, who will serve as executive director until his retirement in 1976. . . . The possibility—but no more—that a Senate-House conference on auto-safety legislation **may restore a mandatory air-bag requirement for 1977** is being held up to semiconductor makers as a balm now that the Senate has gone along with the House in eliminating mandatory seatbelt interlocks [*Electronics*, Sept. 5, p. 79].

These new Unitrode 300V power darlington



perform like this

I_C A	V_{CE0}^\dagger V	h_{FE} @ $I_C = 1A$	$V_{CE(sat)}$ V	Type No.	Package (Modified)	Polarity
2	300	1000 @ $I_C = 1A$	1.5* @ 2A	U2T103	TO-33	NPN
2	300	1000 @ $I_C = 1A$	1.5* @ 2A	U2T203	TO-66	NPN
5	300	1000 @ $I_C = 3A$	1.5* @ 5A	U2T303	TO-3	NPN

$^\dagger V_{CE0}$ measured at 10 mA

*Forced gain = 100

and...

Like all Unitrode Power Darlingtons these new 300-volt units exhibit the lowest saturation voltages available.

Like all Unitrode Power Darlingtons their short turn-on and turn-off times mean unusually high efficiency in fast-switching applications.

Like all Unitrode Power Darlingtons they give you greater savings in design and assembly time and lower component cost than is possible with discrete components.

Like all Unitrode Power Darlingtons they are planar for the highest reliability and stability.

Unitrode's full line of Power Darlington includes PNP and NPN transistors and a wide choice of characteristics in single and dual, mixed or matched, units.

Send for complete details on the entire line of Unitrode Darlington. For faster action, call Peter Jenner at (617) 926-0404. Describe your application on your company letterhead and we'll send a suitable sample.

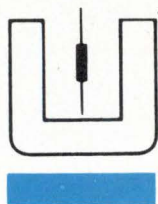

UNITRODE

Circle 29 on reader service card

580 PLEASANT STREET, WATERTOWN, MA 02172

2 NEW OPTO COUPLERS FROM GENERAL ELECTRIC

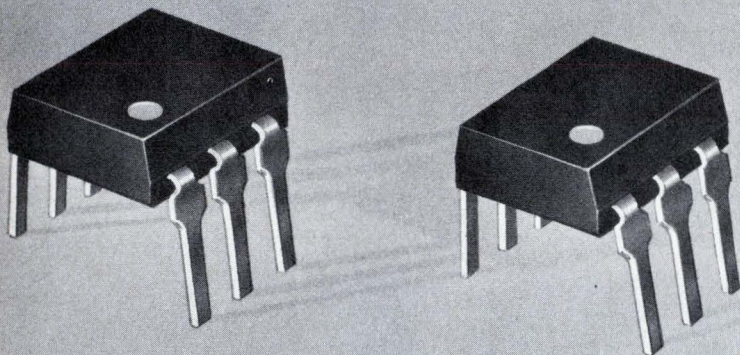

NEW H11AA AC INPUT

- 2 LEDs reverse connected for bidirectional inputs
- 1500 V isolation, 20% min current transfer ratio
- 10% symmetry
- \$1.65 each, 1000 lot quantities

NEW H11A10 SWITCH

- Programmable threshold detection triggerable by 2:1 change in I_{IN}
- 1500 V isolation, 10% min current transfer ratio "on" state
- Covered under "UL" file E51868
- \$1.30 each, 1000 lot quantities

Only GE uses "glass isolation" between the LED and the Detector to achieve optimum and controlled photon coupling....the best combination of isolation voltage and current transfer ratio. The Industry's broadest line of opto couplers competitively priced and available now from any authorized GE Semiconductor Distributor or from any GE Electronic Components sales office.

Semiconductor Products Department, Syracuse, N.Y.

GENERAL  **ELECTRIC**

Microprocessors invade control gear, but builders wary

At tool show, GE, Modicon, and Westinghouse opt for chips; others display minicomputer-based systems

While the inherent conservatism of the machine-tool industry could be expected to hamper the penetration of microprocessors in its equipment, a few producers are building them into everything from loaders for programmable controllers to highly sophisticated computer numerical-control (CNC) systems. For the most part, however, exhibitors at this month's International Machine Tool Show in Chicago were still wary.

"Every time we reach out for a microprocessor—boom, there's a more capable one on the horizon," says one manufacturer. Equally distressing is the lack of alternate sources for available versions, and the devices' relatively slow speeds mean that users build additional hard-wired logic to handle such critical tasks as circular interpolation for contouring purposes.

Nevertheless, major numerical-control manufacturers—General Electric, Allen-Bradley, and Bendix—agree that there's a place for on-board computers in machine tool control and suggest that microprocessors can eventually grab much of the market.

Cost-effective. The largest producer of numerical-control equipment for machining and metalworking showed for the first time a new microprocessor-based system. General Electric's Mark Century 1050 control system is built around



the National Semiconductor Corp. 16-bit chip set, and boasts capabilities—such as the control of up to six axes of motion—usually found only on more expensive minicomputer-based systems. Additionally, it incorporates some features that just haven't been available—diagnostics for both the machine and the control, for example, points out James P. Conley, manager of domestic sales at GE's Numerical Control operation, Waynesboro, Va.

"We went the microprocessor route because it was the most cost-effective," he says. "It also enabled us to do something that everyone has talked about for years—to make a modular control. Each axis requires only one printed-circuit board." The biggest advantage of microprocessors in machine-tool control, adds sales engineer Charles Freed, is higher reliability than either hard-wired logic or minicomputers. That is because a large



Exhibitors. Improved reliability is one of the big reasons for using microprocessors in their new NC controller, according to Charles Freed (top) and James P. Conley of GE's Numerical Control operation.

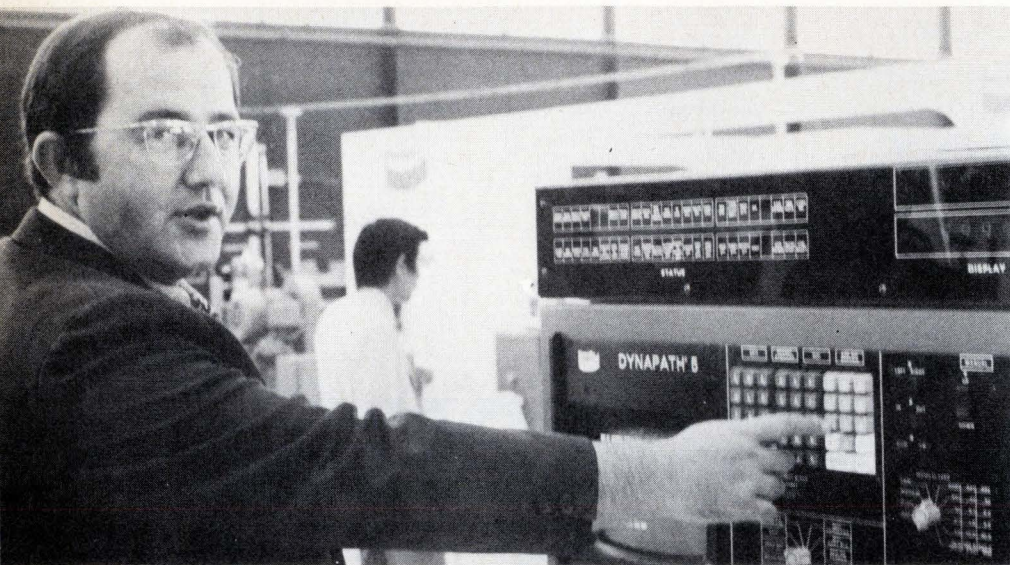

Mini makes it. Slow speed of microprocessors led Bendix to use a minicomputer instead in its new controller, according to Industrial Controls division's Timothy B. Faricy.

number of ICs are replaced by a small number of LSI packages.

Yet the GE system makes major use of hard-wired logic to get around the slow-speed microprocessor for specialized calculations such as conversion between metric and English units, cutter compensation to adapt to different cutting tools, and circular interpolation to generate the necessary axis moves to cut an arc.

New mini too. Bendix Industrial Controls division, Detroit, also introduced its new CNC system—a system that it had earlier said would include a microprocessor. Instead, the DynaPath System 5 is based on the Data General Corp. Nova II minicomputer. “As we proceeded down the microprocessor path, we found ourselves building so much hardware that we felt we couldn’t afford to sell such a hybrid system,” notes Timothy B. Faricy, manager of NC product marketing. “Theoretically, it should work, but in order to compromise for the slow speed of the microprocessor, so much of the system is hard-wired that it’s unwieldy.”

Bendix started with a bus concept—latching more and more microprocessors on a bus to accommodate growing complexity until a mini could be latched on and the microprocessors—which Faricy

points out are not yet cost-effective—eliminated.

Both the General Electric and Bendix systems are designed for the same users, and feature essentially the same capabilities. Neither manufacturer will discuss pricing, except to say that its approach is substantially cheaper than the other’s.

On the other end of the scale, General Automation Inc. intro-

duced an open-loop, continuous-path stepping-motor controller built around its LSI-12 microcomputer with a silicon-on-sapphire microprocessor. “We used the microprocessor to get some advantages of computer control, but basically to make it cheap,” says Allan G. Fiegehen, director of advanced systems for the Anaheim, Calif., firm. “A \$5,000 controller with any features at all is unheard of in this industry.” The GA system is called the Adapt-A-Path L-100.

Microprocessors are also showing up in loaders for programmable controllers. Modicon Inc., Andover, Mass., will begin next month to ship its Model 284, a controller that will replace from 15 to 100 relays. It’s using an Intel MCS-4 in the programming panel to alter from one to four 256-bit programmable read-only memories on site.

And Westinghouse Electric Corp.’s Control Products division has decided to supplement the Datapoint CRT terminals it’s now using to load its PC 400 programmable controller with a Westinghouse-built version of the controller that includes an Intel 8008 microprocessor. □

Lasers

EIA likes the new laser standards proposed by the Federal Government

The construction industry and laser manufacturers may be the winners in the two year struggle with the Bureau of Radiological Health in the Department of Health, Education, and Welfare. The bureau has backed down on the safety standards it had proposed for laser use in December 1973. Now, except for one item, the industry says it can live with the new proposals, submitted earlier this month.

“We like what we see, in comparison with the standards proposed last December,” says Allen M. Wilson, staff vice president, engineering, of the Electronic Industries Associ-

ation. After first feeling out the industry early last year [*Electronics*, Feb. 15, 1973, p. 34], the bureau issued proposals last December, but withdrew them when industry comments warned that the standards could wipe out most of the construction-laser market. The two changes from the December proposals are:

- The bureau dropped the irradiance (power-density) limit of 2.5 milliwatts per square centimeter for lasers used by the construction industry. By retaining the minimum aperture size of 7 millimeters, and specifying a maximum power output of 5 mw, the new proposal

would permit manufacturers to produce lasers with a greater beam intensity than were allowed in the December proposal. Construction-industry lasers—now numbering about 100,000—produce on the average about 2 mW, and the range is between 1 and 5 mW.

■ **Measurement of laser output** is not as stringent as had been previously required. Manufacturers would have had to produce lasers that operated at no more than 80% of theoretical limits to allow for up to 20% error in measurement. Industry said equipment cannot measure output as closely as $\pm 20\%$. The bureau agreed and dropped this measurement requirement. Instead, the manufacturers can build their lasers to within the limits set by their measuring ability, which can vary.

■ **Labeling.** EIA is still unhappy with warning-label requirements, however. The association has been campaigning to get low-power lasers off the "danger" list. The bureau, on the other hand, wants lasers producing more than 1 mW to have "dangerous" printed on the warning label. EIA says a less alarming "caution" label will suffice for these lasers. The bureau is expected to stand its ground on the "dangerous" label, however, saying that a 2-mW laser may cause retinal damage if a person views the beam while wearing glasses or if the beam is accidentally intensified.

The new standard continues to group lasers by class:

■ **Class I**—continuous-wave lasers of up to 0.39 microwatt. No special standards are needed.

■ **Class II**—lasers producing 0.40 μW to 1 mW. Interlocks to prevent radiation exposure are required if the laser-beam-generator housing is accessible; a label on the housing advising caution when using the lasers is required.

■ **Class III**—lasers producing 1 to 500 mW. These must have a danger label, except for some at the low end of the spectrum. However, this exception won't cover most construction lasers, EIA complains. Lasers in this class must also have key-oper-

ated locks to prevent unauthorized use.

■ **Class IV**—lasers producing more than 500 mW. These are considered "classified" and have separate standards.

Manufacturers of lasers in all classes must submit output-test data and quality-control plans for bureau review. Staffers will monitor production lines and spot-test products. After evaluation of comments from industry, the standards may become effective late next year. Industry comments are due Oct. 4.

A few months ago, EIA called the bureau proposals "ultraconservative and overzealous," but compromises have tempered the situation. One major step was taken when the bureau split construction lasers from classroom-demonstration models to end part of the classification controversy. Demonstration lasers for classroom use will be required to have less than 1 mW of power. [*Electronics*, June 27, p. 53]. □

Instruments

Time intervals push femtoseconds

If a femtosecond isn't part of your active vocabulary, it may be soon. Monsanto Co. through its subsidiary United Systems Corp., Dayton, Ohio, has announced a new time interval counter that measures time with a resolution of 100 femtoseconds and is claimed to offer better than an order of magnitude improvement over instruments now on

the market. A femtosecond is 10^{-15} second, or if you prefer, 0.001 picosecond.

Split-picosecond time measurements are vital to engineers and scientists working with lasers used in thermonuclear fusion research, in certain extremely fast data communications applications, and in the design of high-speed logic.

The heart of any good time-interval meter is a precision clock whose pulses are counted during the time interval to be measured. The closer the pulses are to each other, the more precise the measurement. Thus a 100-megahertz oscillator provides pulses spaced 10 nanoseconds apart (the reciprocal of the frequency). And recently, accurate crystal-controlled clocks at 500 MHz have closed up the spacings between pulses to 2 nanoseconds.

■ **Both techniques.** To achieve better resolution, instrument designers have traditionally taken one of two approaches: interpolation or averaging. USC uses both techniques in its model 8330 time-interval counter. The interpolation scheme is essentially the same as that used in the well-known Hewlett-Packard model 5630A computing counter.

During the interval between the start of the measurement and the first measured clock pulse (T_1 in the diagram) a capacitor is charged at a constant current. The capacitor is then discharged at the same constant current during interval T_2 between the end of the measurement and the last measured clock pulse. The resulting voltage on the capacitor is then an analog representation of the interval $T_1 - T_2$ which must be added to the counted interval,

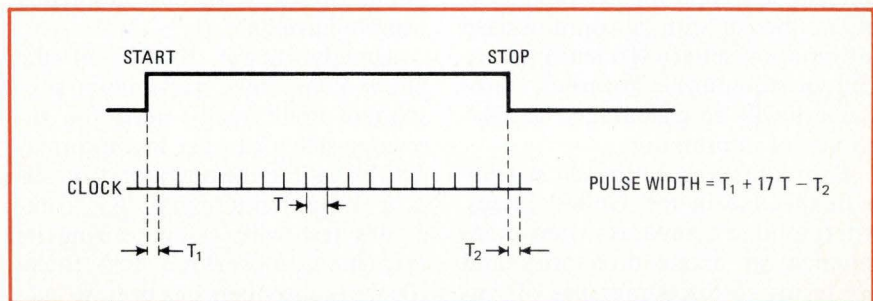

■ **Fast company.** Refinements in technique for measuring time before clock cycles at beginning and end of pulse interval leads to resolution of 0.001 picosecond.

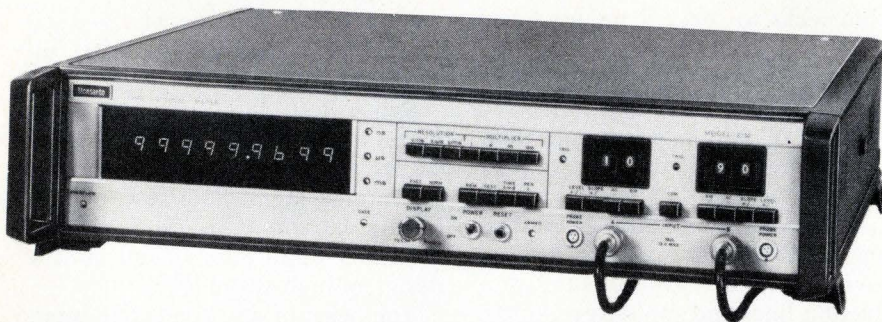

Debut. Femtosecond resolution of new time interval counter from United Systems Corp. should be useful for fusion lasers and in the design of high-speed logic families.

17T, to arrive at the actual interval.

The error signal on the capacitor is converted to digital form by discharging the capacitor at one thousandth of the current at which it was charged, and measuring the discharge time.

Low currents. Extreme accuracy is achieved by using very fast current switches and very low currents. Charging current is on the order of microamperes, and discharge is in picoamperes. Such minute currents minimize the error that would otherwise be contributed by stray capacitance and dielectric absorption.

USC claims its instrument has a single-shot resolution of 100 ps and measurement accurate to within 1%. By averaging a number of measure-

ments, resolution is further narrowed to 100 femtoseconds or 20 times better than H-P's 500-MHz model 5345A, which uses time-interval averaging but no interpolation.

Trigger. Perhaps more significant than the improved measurement technique itself is USC's use of digitally selectable input trigger levels, without which one could make a very precise measurement and not know exactly what was measured. The gate opening and closing levels are set in 10-mV steps by front-panel thumbwheel switches. Carefully matched input amplifiers ensure level repeatability and stability to within 0.1 mV with a temperature coefficient of 0.2 mV/°C. □

Communications

Computer system in Denmark aimed at replacing telephone directories

With paper costs climbing far higher than the tallest Scandinavian spruce, the Jutland Telephone Co. of Denmark is pushing to replace its phone books with a computerized information service. To learn an unknown telephone number, subscribers will be encouraged to telephone for information.

This situation contrasts sharply with the one in the United States, where phone companies want more reliance on phone directories and are trying to discourage use of "information" by proposing to charge each time a subscriber telephones.

In Denmark, on the other hand, telephone subscribers may find themselves having to pay for a phone directory, should they really want to have one.

Already, about 100,000 of the phone company's half-million subscribers don't really need the directory. They can get fast information by calling the operator, who sits at a computer terminal. The company's test with computerizing its information service for these 100,000 subscribers has been so successful that it has ordered a study envisioning development of a similar

system to cover all of the province of Jutland.

The company has four information centers operating today, in Aalborg, Aarhus, Holsterbro, and Kolding. If a computerized system is established—and all indications are that it will be—to cover the entire province, three of these information centers could be closed down at night or during other slow periods while the fourth center takes over.

For its initial test in Aalborg, the company has been using a computer system developed by A/S Regnecentralen of Copenhagen. The RC 3500 minicomputer Regnecentralen uses has 32 separate sets of four working registers, 32 hardware-defined interrupt levels, and an unlimited number of software-defined interrupt levels. The memory-access time ranges from 150 nanoseconds to 1.2 microseconds. The computer's memory holds 32,000 16-bit words.

The terminal that Regnecentralen developed for this application features a CRT screen with 30 to 100 characters per line and 10 to 30 lines on the screen. This means that the display characters can be made as large as possible for easy reading. The screen itself has no refresh memory, since the memory is concentrated in the minicomputer. The system can provide 2 million characters per second from the direct-access memory, and can also accommodate five separate synchronous controllers running at 600 characters per second.

Terminal bank. In the Aalborg information center, there are 10 CRT terminals, but each minicomputer may accommodate up to 32. The keyboard, the RC 812, allows considerable customer design, according to Regnecentralen. It uses the same hardware and circuitry for any number of keys desired, up to 128. The only difference is the actual number of keys and the face panel holding them. The customer can select the number of keys, key layout, colors and symbols on the keys, and the logical function of each key. A case-shift key allows a total of 256 different key functions to be specified. The unit also offers audible

1000 cm/ μ sec stored writing speed, four storage modes, and more.

100 MHz oscilloscope

Tektronix 7633 oscilloscope gives you 100 MHz bandwidth and 1000 cm/ μ sec stored writing speed. So you can retain and view fast rise, low repetition rate, single shot or slow moving waveforms. All with one instrument. This allows you to solve problems in computer sciences, aerospace, ballistics, communications and various other applications.

Multi-mode storage

The 7633 offers four operating modes: Non-store, normal and fast Variable Persistence and Bistable modes are available at the touch of a button. And, an 8 x 10 div. (.45 cm/div.) mode gives the instrument's top writing speed.

Bright, burn-resistant CRT

No special operating safeguards are necessary with the 7633's rugged, burn resistant CRT. This makes it a dependable unit for design bench, hospital laboratory, service facility or classroom. The large 8 x 10 div. CRT is easy to read in both cabinet and rackmount configurations. An alphanumeric readout, exclusive on Tektronix instruments, makes quick on-screen reference and easy interpretation of photographic records. Or, the instrument may be ordered without the readout for \$400 less.

Part of the 7000 Series

Select from thirty different 7000 Series plug-ins. You can custom tailor your instrument to meet your immediate need. And expand its capabilities later as the need arises. A 7633 mainframe costs \$3650. A typical configuration with dual trace vertical amplifier and delaying sweep timebase sells for \$5,550. For rackmount add \$100.

Specifications

Vertical System—Accepts all 7000 Series vertical amplifiers. Bandwidth determined by mainframe plug-in unit up to 100 MHz. Left, Alternate, Add, Chop, Right display

modes. Chopped rate approximately 1 MHz. Horizontal System—Compatible with all 7000 Series plug-ins. Fastest calibrated sweep rate is 5 ns/div. Phase shift between vertical and horizontal is 2°, DC to 35 kHz for X-Y operation.

CRT and Display—Internal 8 x 10 div. (.9 cm/div) graticule with superimposed 8 x 10 div. (.45 cm/div) reduced scan area. Nonstore, variable persistence, and bistable in normal or fast and full or reduced scan storage modes push-button selected. Writing Speed and View Times—From .03 div/ μ sec until erased up to 2222 div/ μ sec at 30 sec view time. View time may be increased more than 30 times by using reduced intensity in the SAVE display mode.

See for yourself

For a "hands-on" demonstration, contact your nearby Tektronix Field Engineer. Or write: Tektronix, Inc., P. O. Box 500, Beaverton, Oregon 97005. In Europe write: Tektronix Ltd., P. O. Box 36, St. Peter Port, Guernsey, C. I., U. K.



TEKTRONIX®
committed to
technical excellence

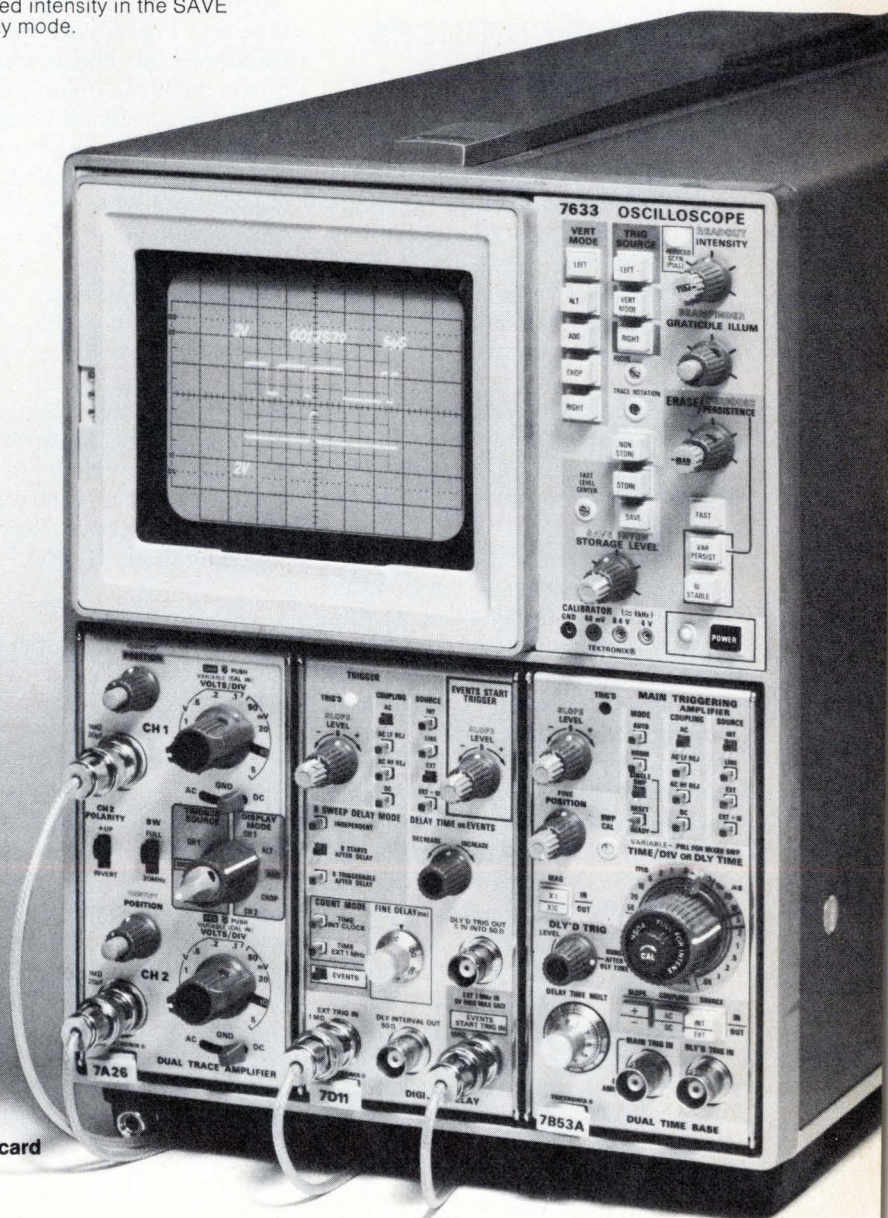

Circle 35 on reader service card

For a demonstration circle 34 on reader service card

and visual signals for up to eight keys each.

In the Jutland phone system, the operator types in the name and address of the phone number requested, and the number is presented on the screen. The company last year, for the entire system, handled 5.5 million inquiry calls. Obviously, if phone books are eventually eliminated, the number of inquiries would increase. Company officials, however, expect people will start keeping better personal phone-number files. "You'd be surprised how many people never use their phone books anyway," one company man says. □

Commercial electronics

Printer reproduces videotapes quickly

A videotape contact printer developed by Matsushita Electric Industrial Co. can copy a 30-minute master cartridge onto a 1/2-inch videotape cartridge in less than three minutes. This is more than 10 times as fast as copying by normal tape playback, and it eliminates the need for banks of recorders to obtain reasonable throughput. The so-called cartridge VTP system prints without removing the tape from the cartridge.

The printer opens the way to two new types of business operation that could greatly simplify sales of video software and eliminate most inventories. A distributor or shop could stock master cartridges and blank cartridges, and make copies for customers as required. Master copies could even be stored in a vending-machine, and a customer could copy them onto his own blank tapes or he could copy new programs over old ones that he no longer wants to view.

Matsushita earlier developed a method for contact printing of open-reel tapes [*Electronics*, March 31, 1969, p. 181]. But until now, the company was unable to do the same

thing with cartridge tapes. The big problem was that the thick leader on the cartridge made it impossible to wind the master and blank tapes together smoothly on a reel.

Bifilar. A group headed by Hiroshi Sugaya in Matsushita's central research laboratory solved this problem by using dual concentric hubs that enable the leader tapes to be taken up by the inner hub and the bifilar winding of the magnetic tape to proceed smoothly on the outer hub. Also lending a hand with an assist on mechanical systems was Matsushita vice president Tetsujiro Nakao, who has expertise in design of mechanical systems and modifications of systems for increased productivity and reliability.

As in the earlier videotape printers for open-reel tape, the master tape has higher coercive force than standard tape and is recorded as a mirror image. To duplicate the program, the master and slave tapes are wound tightly together at high speed onto one reel, and a magnetic field is applied for one second. The tapes are then rewound on their respective reels. The entire operation takes two minutes and 50 seconds.

Matsushita says that each master tape will provide at least 1,000 copies. The master-tape cartridge is somewhat larger than a conventional cartridge. Matsushita will sell the videotape printer in Japan for about \$15,000, and the recorder that makes the master tapes will be priced at about \$17,000. □

Digital link aims at truckers

Operators of truck fleets are beginning to explore the possibilities of using digital communications to keep tabs on their trucks on the road and to give them a head start on paperwork and scheduling.

One of the latest such systems is Cadec, or Computer Aid to Dispatching En-route Carriers, developed by General Systems Development Corp., Waltham, Mass. De-

signed for fleets specializing in local pick-up and delivery, the system relies on the truckers' two-way mobile-radio link. The technique combines digital and voice transmission, as do systems already being used by several police departments around the country [*Electronics*, April 18, p. 68] and, to a lesser degree, by taxi fleets [*Electronics*, Feb. 7, p. 39].

The Cadec System relies on a data-collection terminal mounted in the driver's compartment that sends its data through the trucker's uhf transceiver; a base station consisting of a cathode-ray-tube terminal and line printer at the truck's home office; and a minicomputer at a GSD office which is time-shared via telephone lines with the truckers who buy the service. The processor station organizes the data for display to the truck company's dispatcher.

Send only. The digital terminal in the truck mounts up against the roof of the driver's compartment. It measures 8 inches wide, 10 inches deep, and 5 inches high, and is basically for sending only. Weighing 20 pounds, it has a 10-digit keyboard and a dial for selecting the functions being performed by the driver. Mostly, he's supposed to enter information contained on the bills of lading accompanying cargo picked up at each stop. Setting the function dial to "enter bill," for example, he punches an eight-digit code that denotes the cargo's weight, number of pieces, and destination.

And before leaving the stop, the driver could also dial "enter stop," followed by the two-digit code for his next destination. The trucker can also enter codes for such things as coffee and lunch breaks. In addition, a sensor on the vehicle's odometer records mileage and length of time at stops.

When the data has been entered and stored in a buffer, the driver turns the dial to the "Send/Off" position and the data waits until the unit is polled by the equipment in the truck company's base station. Transmissions between the base and trucks are handled in 32-bit words. Forty vehicles per second can be accommodated. This many vehicles

DRIVERS TEST:

1. The 75451 series of dual peripheral drivers has a breakdown voltage of:

- 7-1/8 inches
- 30 volts
- 18 pounds

2. The National Semiconductor DS 3611 series of dual peripheral drivers, which is pin-for-pin compatible with the 75451 series, has a breakdown voltage of:

- 7-1/8 inches
- up to 80 volts
- up to no good

3. The DS 3611 is better for:

- cleaning your teeth
- driving lamps, relays and solenoids
- making pepperoni pizzas

4. To use the 75451 is therefore:

- smart
- silly
- silly if you operate near or over 30 volts
- delicious if baked in a 300° oven for 45 minutes

5. To get the DS 3611:

- rub your stomach in a counterclockwise rotation as you pat your head
- hold your breath
- call your local National Distributor

6. Can you spot the DS 3611 in this picture?

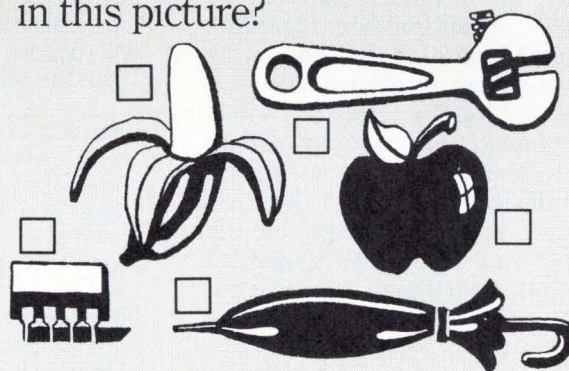

NATIONAL

National Semiconductor Corp., 2900 Semiconductor Drive, Santa Clara, Calif. 95051; Scottsdale, Ariz. (602) 945-8473; Mountain View, Calif. (415) 961-4740; Sherman Oaks, Calif. (213) 783-8272; Tustin, Calif. (714) 832-8113; Miami, Fla. (305) 446-8309; Chicago, Ill. (312) 693-2660; Indianapolis, Ind. (317) 255-5822; Lenexa, Kan. (816) 358-8102; Glen Burnie, Md. (301) 760-5220; Burlington, Mass. (617) 273-1350; Farmington, Mich. (313) 477-0400; Minneapolis, Minn. (612) 888-4666; Englewood Cliffs, N.J. (201) 871-4410; Syracuse, N.Y. (315) 455-5858; Dayton, Ohio (513) 434-0097; Dallas, Tex. (214) 233-6801.

can be polled twice a minute, leaving 29 out of every 30 seconds available for voice communications. Each truck terminal also has a plug-in identification code associated with a time slot when the vehicles are polled.

The truck terminal is built around four specially designed metal-oxide semiconductor chips. Enough memory is in a buffer stack for 16 messages of 8 characters each. Digital information goes through a 2,400-bit-per-second modem for transmission on the mobile-radio carrier. A power supply of +5 volts and -12 volts is included to provide power while the truck is being started, when battery voltage would otherwise disappear. Logic for built-in diagnostic tests is included also.

At the truck-company office, information is presented on an Infoton Inc. CRT terminal, and a Centronics Data Computer Corp. line printer for permanent records. At the GSD office in Waltham, the terminals share a Data General Corp. Nova 1200 with 32 kilobits of core memory and a 256-kilobit disk memory. One Nova can handle about 1,000 trucks, but within a year, similar processing stations will be established in other cities, says GSD president William T. Quinn.

Management data. On the CRT display, the dispatcher can call up all sorts of information regarding the fleet's operation. In addition he now can gauge the efficiency of each driver. And, although no one wants to comment, this checking should tend to keep drivers on their toes. Also, all stops in excess of two minutes receive special notice by the system. This allows the trucker to bill supplemental time charges if the customer is found to be causing the delay.

Another advantage of the system is that the paperwork involved with each shipment is taken care of during the day and while local trucks are still out picking up cargoes. Once the local trucks arrive, their cargo can be moved smoothly to the long-haul trucks. Quinn estimates that the Cadec system can save 30 minutes per day per truck and help

News briefs

Sanders Associates taking antitrust action against IBM

The president of Sanders Associates Inc., Nashua, N.H., says he's filing an antitrust complaint against IBM and is seeking to recover triple damages for alleged losses that include the net loss of \$19.1 million in fiscal year 1974. President Royden C. Sanders Jr. charges that the negative results, coming on sales of \$162.3 million, are "a direct consequence of monopolistic marketing practices by IBM." Sanders, which markets a display terminal largely to customers with IBM computers, says it was damaged when IBM refused to support the interface between the Sanders terminals and IBM machines in new applications. As a result, Sanders says, new orders in 1974 fell below expectations, and lease terminations increased significantly. The company also accuses IBM of another anticompetitive practice in withholding interface specifications for its new equipment. In 1973, Sanders had a net income of \$5.9 million on sales of \$171.1 million.

Says a spokesman at IBM, "It is regrettable that Mr. Sanders would explain his company's losses by alleging that responsibility lies elsewhere."

Wrist calculator, 'world's first,' is announced

You know about hand-held calculators, but here's one you can wear on your wrist. Robert Fondiller of the Fondiller Corp., New York, N.Y., says his company has developed a 40-function, nine-digit readout electronic calculator and digital watch—all contained in a package 1½ inches square and less than ½ inch thick. The calculator is operated by 20 buttons, Fondiller says. He explains that twice that number of functions is attainable by employing a shift key, "like a typewriter." And when you're not calculating, the nine-digit LED display on the \$500 device will tell time.

Orders down for electronic parts . . .

The Electronic Industries Association reports a 7.52% decline in the dollar value of new orders for electronic parts during the first half of this year, compared with the first half of 1973. On a month-to-month basis, the EIA figures show a steady decline since February, when the value of new orders was 10.2% higher than in February 1973. During June of this year, according to the EIA, the value was down 15.51% from that of June 1973.

. . . with a footnote from American Microsystems

Because of a "pronounced flattening" of the market for MOS/LSI circuits, American Microsystems Inc. says it is cutting its work force by about 6%, or 230 people, and shutting down its manufacturing operations during Thanksgiving and Christmas weeks.

Bendix gets Mitsubishi order

Japan's Mitsubishi Corp. has ordered a \$500,000 earth-resources data-analysis system from the Bendix Corp. The system, developed by the Aerospace Systems division, Ann Arbor, Mich., is a self-contained station consisting of a digital computer utilizing a 1.2-million-word disk memory, operational programming and a color-TV display and controls.

Silent crew member aboard Courageous

Installed aboard the America's Cup defender, Courageous, was a 16-kilobit memory minicomputer converted from 110-volt ac to 36-volt dc operation. The Nova 1200, provided by the Data General Corp., performed navigation calculations needed to obtain the best speed from the craft.

New FCC rf requirement postponed

Makers of low-powered rf devices have received a six-month reprieve for filing power-output compliance data to the FCC. The new regulation was to have gone into effect Sept. 1, but the FCC said administrative problems required a delay. In the past, manufacturers self-certified that their devices complied with FCC regulations.

We're doing everything we can to keep on top of your needs.

Shortages. Crises. Delays. At times like these they're a fact of life.

At Brand-Rex we're doing something about them. We've instituted a company-wide program to foster a "Yes We Can" attitude to supply problems. And we've taken dozens of steps to make our problems less burdensome to our wire and cable customers.

Here's a sampling of what we're up to:

Production. We're minimizing waste and scrap by grouping orders using the same materials. We're modifying existing equipment to make it operate more efficiently. And we're keeping tabs on critical customer needs, giving them preference as far as possible.

Purchasing. To get maximum utilization from available resin and plasticizer, we've eliminated special purpose and low usage PVC compounds. We've raised our sights to include the world — we're searching out new supply sources overseas. At the same time, we're working with our long-term vendors to coordinate their production schedules with ours.

Product Engineering. Our engineers have come up with acceptable substitutes for hard-to-get PVC compounds — without compromising performance or service life. They're constantly evaluating new available insulations and developing new manufacturing techniques for those showing promise.

Shipping. We're using new packaging methods that virtually eliminate damage in transit. And where possible, we're consolidating shipments for better delivery service.

Sales and Marketing. We've given our salesmen an additional responsibility: calling on our vendors in



their territories to keep materials moving. We're using computers to keep track of customers' behind-schedule orders and giving them the extra attention needed to get them out on time.

What you can do. We're asking our customers to call us before new wire and cable specifications are finalized so that "tight" materials can be avoided or alternates provided for. And doing everything else that will help us help you.

We're not deluding ourselves. None of these steps is going to bring an end to the problems we all face. But they can make a difference — if we all work at it. After years of providing the best possible wire and cable service, we're not about to quit now.

Brand-Rex

Willimantic, Conn. 06226

**Yes
we can.**

Electronics review

cut down substantially on overtime.

An installation for a 40-truck fleet, including the truck sets, runs about \$65,000, Quinn says. The time-shared central-processing capability costs an additional \$20 per month per truck.

The first Cadec installation is now in place at a Hemingway Transport Inc. terminal in Woburn, Mass. However, GSD is looking into mass-transit applications where it could be used, for instance, to improve service and even reduce the number of buses needed on a bus line. □

Industrial electronics

Smart TV camera improves extrusion

A smart electronic-inspection "eye" out on the factory floor is helping to improve quality and turn out products faster. One prototype system in particular—for an extrusion controller in a rubber plant—has worked so successfully that it will be moved into production shortly.

The inspection system relies on the Smart Video Camera, introduced about a year ago by Reticon Corp., Mountain View, Calif. [*Electronics*, July 5, 1973, p. 32; Feb. 1, 1973, p. 121]. Its "eye" is a linear array of MOS photodiodes. Its intelligence comes from a microprocessor-based controller.

"We've found it possible to at least double the production rate of the standard extruder," says Dean Tellinghuisen, manager of controls engineering at the AMF Tire Equipment division, Santa Ana, Calif.

Up to now the division's extruder systems had incorporated only linear transducers and servomechanisms to control the width of hot, malleable rubber strips for new tires as they passed through a roller network and out an extruder. But the width of the strip varied with the speed of the rollers and could only be kept within gross limits. "There was no way to get real precision because there was no real-time way of



Smartie. Microprocessor-based controller helps solid-state camera make decisions.

getting information about the width of the extruded strips back to the motors that controlled the rollers," says Tellinghuisen.

Feedback. The smart camera provides that feedback. Camera thresholds are set so that the strip registers black against a white background. When the strip starts to "drift"—that is, when it comes out too wide or too narrow—the microprocessor recognizes this and feeds the information back to an interface controller. This controller then varies the speed of the stepper motors on the rollers.

"This gives us the ability to control the width of the rubber strips to within 0.003 of an inch," Tellinghuisen says. "The system also allows us to detect drift trends and take corrective action well before the strips have gone beyond the specified tolerances."

The key components in the camera system are Reticon's IC 600 solid-state camera with a sensor array consisting of 64, 128, 256, 512, or 1,024 MOS photodiodes, and a RS-600-series controller, with an Intel MCS-4 microprocessor set.

Depending on the working distance and the choice of lens, the camera looks at a field of view from a fraction of an inch to several feet on a side. The field is imaged onto the array, which is scanned electronically to produce a train of electrical pulses. Each pulse's amplitude is proportional to the light intensity on the corresponding diode.

These pulses are then compared to a stored set of threshold levels to produce a train of binary pulses—zero for light below threshold (black) and one for light above threshold (white). The pulses before and after a black-white transition

can be counted electronically to determine such things as the position of an edge, the location of a flaw, or the width of a strip.

However, it is the controller with its microprocessor set that allows the camera to perform different chores. These include making go/no go inspections, feeding raw data to a remote computer for processing, and actuating sorting mechanisms and supply feedback control.

The microprocessor includes up to 16 2,048-bit programmable read-only memories (PROMs) with 4-bit input/output ports, four 32-bit random-access memories with 4-bit output ports, a 10-port shift register for input/output expansion, and the central processing unit.

Eight of the PROMs perform basic arithmetic and calibration duties on the camera. The physical measurements of what is to be observed are set into the PROMs by means of thumbwheel switches while the camera is trained on its subject to register an electronic "signature" of low and high pulses.

Other PROMs handle executive routines and interface with a teletypewriter so that a human operator can change the programing when necessary.

Reticon president John Rado says that about 50 of his camera systems have been sold. □

Communications

Special carriers get big new customer

The shaky specialized common-carrier business, along with other Bell System competitors, will share in new annual revenues that could

one way...

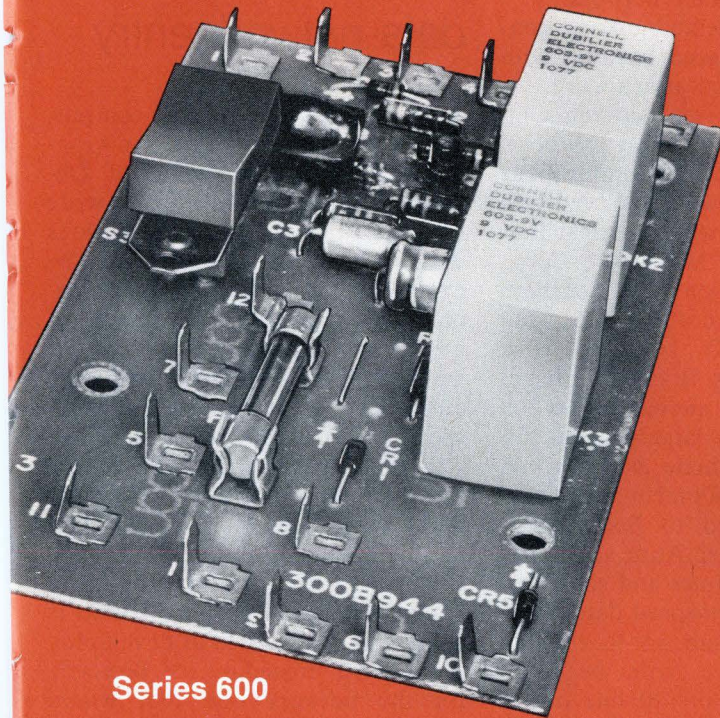

Series 600

or the other

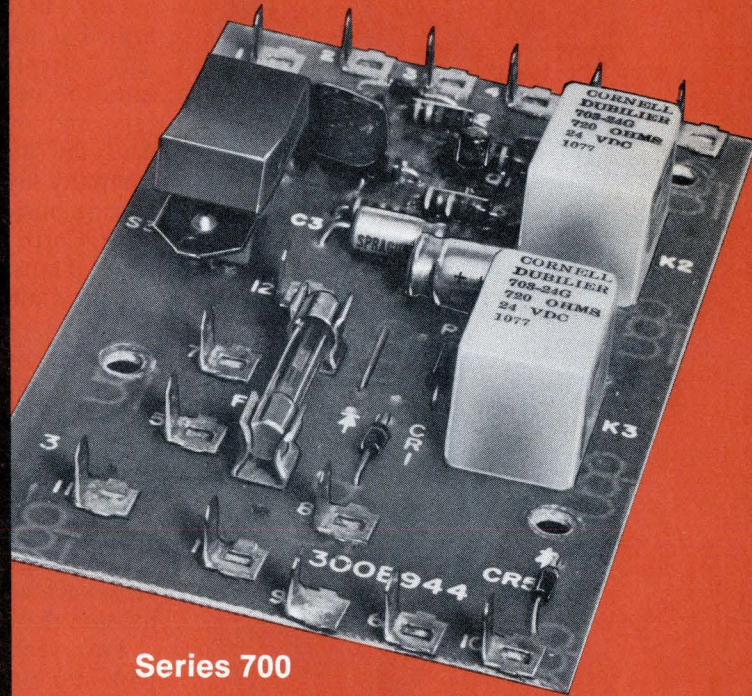

Series 700

CDE Solves Your "Cost Crisis" Problem in Relay Switching!



This 130 page Component Selector Guide presents in detail all CDE products... from ceramic to electrolytic capacitors... from mica to paper capacitors... from Relays to EMI Filters.

LETTERHEAD REQUEST ONLY!!!

Here are two CDE relays that give you miniaturization, proven reliability, outstanding performance . . . all at an unbelievable low cost. Both series are stocked in depth for immediate delivery . . . in a variety of standard coil voltages. Check the specs below. If either the 600 Series or the 700 Series can't help solve your spec/price problem . . . we'll make a special for you, and we'll keep the cost competitive. In fact, if your needs include any type of miniature relay, general purpose relay, bi-stable relay or time delay relay . . . contact CDE.

	Series 600	Series 700
SIZE:		
Chassis Space	1.22" X 0.77"	0.97" X 0.67"
Height	1.20"	0.79"
CONTACTS:		
	SPDT or DPDT UL listed from 2 amp resistive to 480VA, 240VC, Pilot Duty	SPDT Up to 5 amps resistive
DC SENSITIVITY:	60 MW DC min.	450 MW DC min.
AC:	SPDT available	Not available.
PRICE:	Typically about \$1.	Usually 20% less for similar switching specs.

CDE **CORNELL-DUBILIER**

150 Avenue L, Newark, N. J. 07101

For detailed spec. sheet, circle Reader Service Number listed below!

CDE — The People to People Company
— the mark of quality is on everything we make.



Circle 41 on reader service card



GOOD

BETTER

BEST

Choosing the right cassette is easy... if you have a choice. CONRAC gives you 3 excellent cassette series so you specify the right one for your application.

- D Series—standard polystyrene case—good low cost applications with standard requirements.
- F Series—Glass-metal filled plastic case. Premium performance, general purpose digital cassette built to ANSI/ECMA standards.
- CM Series—metal computer grade case. Total performance ANSI/ECMA. Tape density 800 bpi or 1600 FCI. Speeds read/write 50 IPS, search 300 IPS.

Write for descriptive literature.

CONRAC CRAMER DIVISION
CORPORATION

Mill Rock Rd., Old Saybrook, Conn. 06475
(203) 388-3574

Electronics review

grow to \$15 million annually as Aeronautical Radio Inc. has begun to place with them orders for private-line microwave services for its airlines communications network.

Early in September, Arinc confirmed it has placed business with MCI Telecommunications Corp. for some of its services between Chicago and other Midwest locations. And the airlines' communications company says it will regularly begin placing business with American Satellite Corp., CPI Microwave Corp., Data Transmission Co., Southern Pacific Communications Co., and Western Union Telegraph Co. Arinc estimates that up to one-quarter of its \$60 million annual outlay on communications—largely spent for American Telephone & Telegraph Co. lines and equipment—will eventually be shifted to Bell System competitors which, Arinc says, offer generally lower rates and some services such as high-speed data transmission that are superior to AT&T's.

Two years ago Arinc began to look into buying private-line service from non-Bell carriers [*Electronics*, Dec. 18, 1972, p. 49] rather than build its own microwave system. Arinc indicated last year that it planned to hedge its bet by asking FCC permission to build its own Chicago-area system while contracting out services to non-Bell carriers in the West Coast area [*Electronics*, June 7, 1973, p. 53]. Now, with what it calls a "sizable" order to MCI for the midwest area, the company-owned system may not be built.

Even though AT&T is expected to retain 75% of Arinc's business, it can be expected to fight to keep all of it by moving to cut charges and upgrade services, according to communications industry officials. "Bell appears to have lost another battle," says one, "but the war is hardly over." AT&T declined to comment.

Arinc acts as a clearinghouse for the nation's airlines, supplying an intercity private-line network for reservations, operating reports, and administrative messages. Altogether, the organization is one of the largest users of communications services in the country. □

Computers

Study may simplify data-network entry

With 16 different types of computers and software systems, the Arpanet—the U.S. Department of Defense's experimental nationwide computer network—has an obvious disadvantage. A user must know exactly which of the complex sign-on and coding procedures are required for the computer he wants to address. Mistakes are far too easy, and merely getting the system to respond properly can take time.

Trying to speed up the process, the Institute of Computer Sciences and Technology, part of the National Bureau of Standards in Gaithersburg, Md., is developing a "network-access machine" that is compiling data aimed at developing a standard procedure, or protocol, for the network—one that would present a minimum of difficulty for "getting on" with any of the more than 40 computers in Arpanet [*Electronics*, Dec. 20, 1971, p. 64; May 2, 1974, p. 98].

Computer networks, which tie together the power, software, and resources of computer systems scattered throughout the country, are predicted to be fast growing for the next 10 years. Most commercial nets have one type of computer and telephone-line type of interconnections in which a path is maintained for each transaction.

However, new commercial networks, such as those now being constructed by Telenet Communications Corp. and Packet Communications Inc., which should be in operation next year, will, like Arpanet, rely on the interconnection of many different types of computers owned by their customers.

Packet-switching. Rather than having a "solid" telephone-line interconnection, these new networks, like the prototype Arpanet, employ packet-switching techniques. In packet-switching, the path for a

**If you are
serious about
solving EMI
problems...**

**...this
Designer's
Kit is FREE!**



If not...

**...it'll
cost you
\$35.00**



New Designer's Kit on EMI Filters and Systems Engineering Services.



These Kits are in production now . . . and quantities will be limited.

To reserve your EMI/EMC Designer's Kit #2... write, on your letterhead to Marketing Communications, Cornell-Dubilier Electronics, 155 Avenue L, Newark, NJ 07101 or call (201) 589-7500, extension 480.

This is the most comprehensive package of helpful, useful, and practical information concerning Electro-Magnetic Interference ever offered! To the serious designer, it's free . . . on letterhead request only . . . and for a limited time.

This is what it contains:

- Reactance Slide Rule
- 44 page EMC Solutions brochure
- All Purpose Filter Catalog
- Useful Engineering Data Product Sheets
- Government Interference Restrictions brochure
- Article Library . . . containing reprints of recent technical articles from major publications
- Application Engineering Questionnaire
- And More

CDE **CORNELL-DUBILIER**

CDE — The People to People Company
— the mark of quality is on everything we make.



155 Avenue L, Newark, N. J. 07101

Efficiency Experts

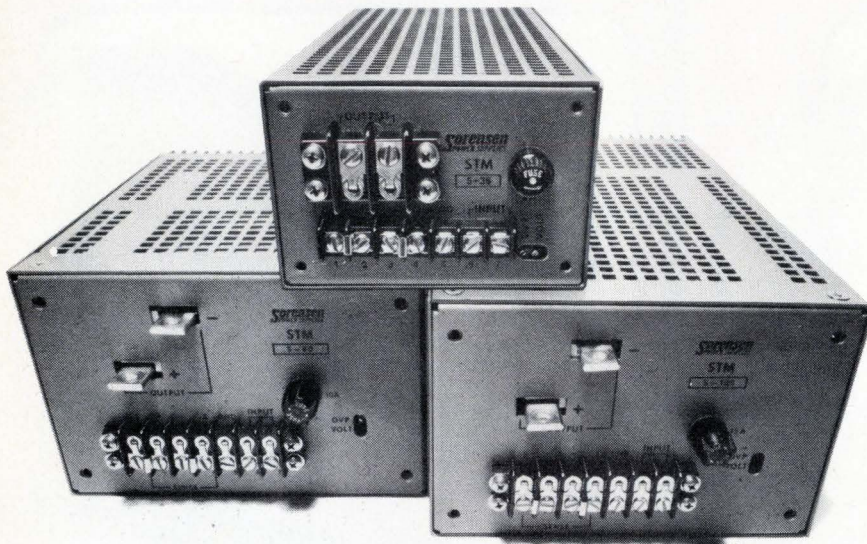

Built to save energy—modular STM switching-transistor power supplies from Sorensen. Exceptional power density and efficiency. Up to 1.5 watts per cu. in., and up to 75% efficiency in half the space of comparable competitive units. 40 models offer outputs from 72 to 780 watts (3 to 56 volts)—all with these features: cool running . . . excellent performance characteristics . . . built-in overvoltage protection . . . quiet operation . . . adjustable current limiting. For complete data, contact the Marketing Manager at Sorensen Company, a unit of Raytheon Company, Manchester, N.H. (603) 668-4500.

Representative Specifications—STM

Regulation (comb. line & load)	0.05%		
Ripple (PARD)	rms: 3 to 10 mv. p-p: 30 mv. typ.; 50 mv. worst case		
Module Sizes & Prices	Module	Size	Price
	III	5.12" x 3.31" x 9.50"	\$240-270
	III A	5.12" x 3.31" x 14"	\$300-330
	IV A	7.5" x 4.94" x 10.5"	\$475-495
	VI	7.5" x 4.94" x 14"	\$600-650

Sorensen
POWER SUPPLIES

message may change during transmission if conditions require it. Standard protocols that may be developed by the Bureau of Standards to simplify Arpanet procedures could be applied to simplifying the procedures and software required by the commercial networks as well. Furthermore, the design of the networks themselves, including the terminals, software, and even some features of the central processors, could also be affected.

The network-access machine, which went into operation this summer under the direction of Thomas N. Pyke, acting chief of the Computer Systems and Engineering division of the institute, stores the different Arpanet protocols and keeps track of the difficulties encountered in their use. The machine, a Digital Equipment Corp. PDP-11/45 computer with special hardware and software, is connected to an Arpanet terminal at the institute.

Other computers in the network can be dialed up by the machine, which can also call for any of the host's programs that it wants to use. Or the machine could be used on commercial networks as well.

Under the present, awkward setup, to connect to the Honeywell 645 at MIT in Cambridge, Mass., the following sequence might be required (parentheses enclose a single keystroke):

@r(LF)@e(SP)r(LF)@L(SP)70(LF) whereas a connection to the IBM 360/91 at UCLA might require:

@r(LF)@t(SP)o(SP)L
@r(LF)@t(SP)o(SP)L
(LF)@i(SP)L(LF)@L(SP)65(LF)

Both would be followed by other equally difficult symbolic sequences that identify the user by name, password, and account number.

But, with the access machine, a user might simply enter through his terminal a message as simple as:
CALLING CAMBRIDGE,
LOG IN JOE SMITH,
PASSWORD FRIEND,
ACCOUNT NO. 123456

The machine would translate this into the necessary sequence of @, (LF), (SP), and other symbols recognized by the computer. □

AIRPAX™

Type 209 E-Frame Circuit Breakers

for panel board and
large equipment applications

Airpax Type 209 molded-case circuit breakers are designed for use by the original equipment manufacturer. □ The hydraulic/magnetic principle provides stable trip points over a wide ambient temperature range. □ Typical applications include: refrigeration, air conditioning, power supplies, computers, and others.

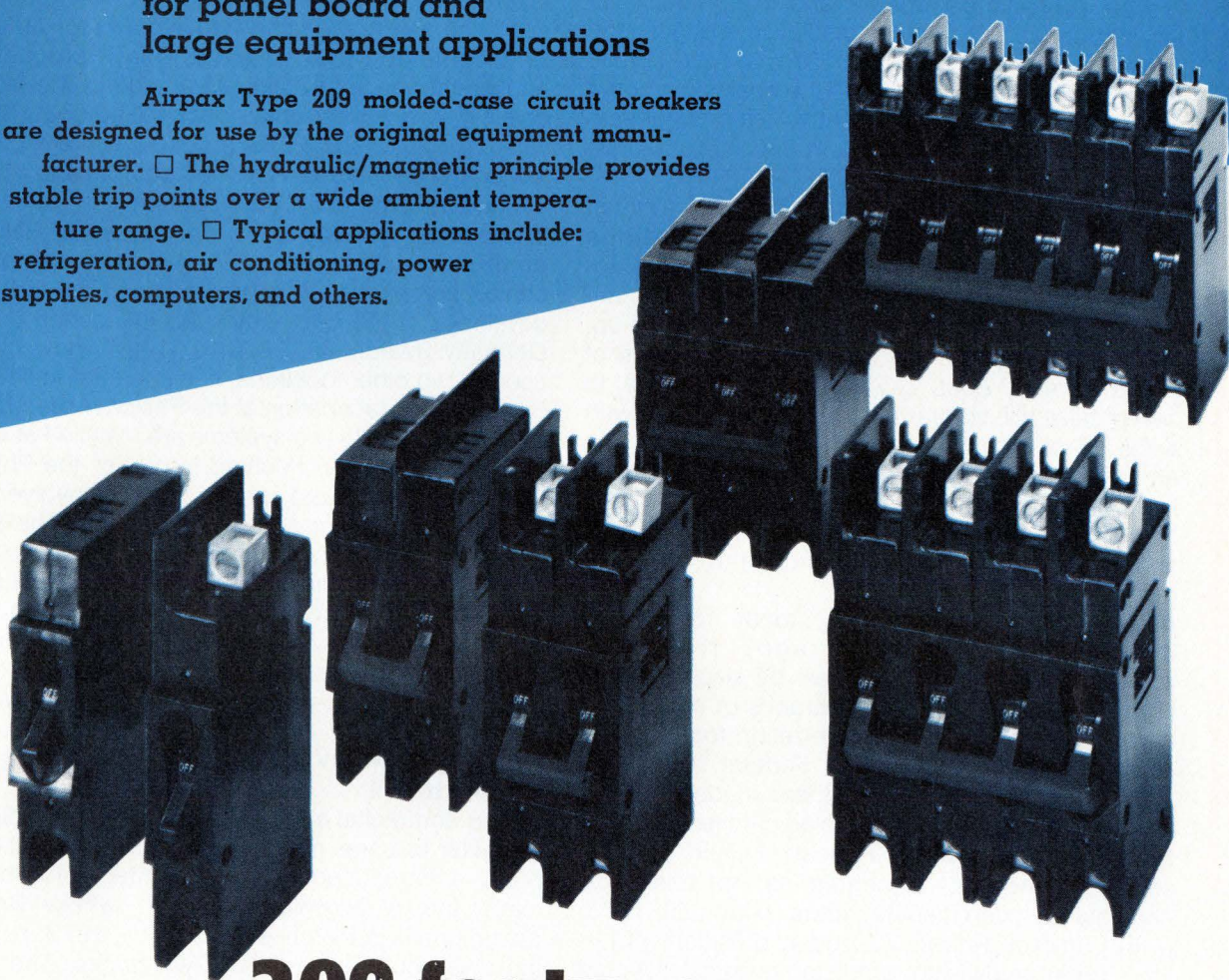

209 features

U.L. listed for branch circuit protection.

Current ratings to 100 amperes.

Voltage: 125V dc	120/240V ac
240V ac	277/480V ac

Construction: Series, relay, shunt, auxiliary switch.

Terminations: Solderless connector, screw or stud terminals.

Time Delays: Instant, short, medium, or long.

For more information about these compact, competitive Type 209 breakers, write for Airpax Bulletin 2012.

AIRPAX™

Airpax Electronics
CAMBRIDGE DIVISION
Cambridge, Maryland 21613
Phone (301) 228-4600
Circle 45 on reader service card

News update

Itek awaits U.S. cash for 84-character LCD

Who would want an 84-character liquid-crystal display that doubles as a solid-state cathode-ray tube? The Army would, which is why the Itek Corp.'s Applied Technology division is still waiting patiently for a Government contract to support development. Meanwhile, the display, which Itek has linked in prototype to a miniature electronic-warfare computer, is still being proposed for use in such other airborne systems as the Wild Weasel surveillance receiver and in portable military ground equipment to display messages and map coordinates [Oct. 25, 1973, p. 29]. While waiting for the Federal funds—the deal is expected to be signed later this month—Itek's engineers have done some design work in the display's drive circuitry.

Telenet to start service on packet-switched net

Now that Telenet Communications Corp. of Washington, D.C., has received FCC approval of its packet-switched business-communications network, customers are starting to sign up. While the company won't disclose the names of subscribers, it does say that limited service to seven cities will start at the beginning of 1975 with a full 18-city network scheduled to open by the end of the year. Meanwhile, Telenet has accepted five systems from Prime Computer Inc. of Natick, Mass., and says it will have software developed shortly. About 7,500 miles of circuit have been ordered from AT&T.

Microwave ovens selling, despite CU study

About 18 months ago, the Consumers Union stirred a tempest by slapping "not recommended" labels on 15 brands of microwave ovens it had tested. The organization took the opportunity to lash out at the Federal microwave emission standards, calling them inadequate. At the time, the Bureau of Radiological Health of the Department of Health, Education, and Welfare stoutly defended its standards, as, not unexpectedly, did the oven manufacturers [March 29, 1973, p. 62]. In fact, Robert T. Bruder, president of Litton's Atherton division, predicted oven sales would grow at a "very healthy rate." Well, it appears that Bruder was right. Total sales of microwave ovens in 1973 was 500,000 units valued at \$200 million, while the number this year is expected to top 650,000 worth \$260 million. In fact, Litton itself has completed its recent expansion in Plymouth, Minn., and is now adding another 320,000 square feet. When the \$8.2 million facility is opened early next year, it will be dedicated to turning out the company's Micromatic line of microwave ranges (a range is a microwave oven mounted above a conventional electric range).

Economics blamed for 4-in. wafer silence

The world isn't exactly beating a path to the door of Wacker Chemical Corp. in New York City demanding 4-inch silicon wafers. While 3-in. wafers have pretty much become a semiconductor industry norm, says Wacker's Mel Littman, a sales representative, the semiconductor industry's slowdown has removed most of the temptation anyone might have felt to switch to 4-inchers. Littman says that orders for samples have been taken to the tune of a few hundred a week, but he can't see any real demand developing for at least six months to a year. Users also lack production equipment needed to take advantage of the larger crystals. And while Wacker once talked about 5-in. versions [March 29, 1973, p. 25], those are pretty low on the priority list. "We may go from 4 to 4¼ or 4½ before we go to 5," says Littman.

Three laser systems to control crystals in use

The use of Philips' laser system to control crystal growth is proliferating. The system, developed at the company's lab in Aachen, West Germany [March 29, 1973, p. 47], is now being used in two other locations. It is engaged in single-crystal garnet fabrication at the Philips research lab in Hamburg, while two systems are installed at Mullard in Great Britain (Mullard is part of the Philips group of companies) where they're involved in crystal development and preproduction. The system solves the problem of irregular diameter variations, which in normally grown crystal (using seed-pulling and crystal-rotating techniques) can lead to structural imperfections. With the laser technique, the diameter of the crystal can be controlled and measured with an accuracy to within 1%.

One-chip DPM/DVM starting to sell

A single-chip IC offering both the analog and digital electronics for a 3½-digit digital voltmeter or panel meter is beginning to realize its promise. Introduced last year by Integrated Photomatrix Inc. of Mountainside, N.J., whose British parent firm is in Dorchester [Oct. 11, 1973, p. 44], the chip could halve DPM/DVM prices. The reason: those instruments heretofore have needed separate analog and digital segments, plus peripheral display decoder/drivers and reference supplies. Since introduction of the chip, its accuracy has been improved by a factor of 2 so that it is now quoted as within 0.1% plus or minus one digit. Though only 100 parts were provided last year as prototypes—and those were made in Britain—an American LSI house is now turning out 100 a day; lead time for orders ranging from 1,000 to 5,000 is four weeks. The price in large quantities is \$10.50; in 1,000 lots it's \$19.65

—Howard Wolff

Intended to bring *Electronics* readers up to date on news stories of the past months.

An offshore plant will reduce your electronics manufacturing costs.

On paper.

The competitive challenge of imports hasn't hit any market harder than electronics. An offshore plant with low labor rates seemed to offer a convincing way to regain the profitability edge. Until the plant was built and local realities set in. Restrictive labor regulations, stretched logistics, and unfamiliar conditions all tended to eat up those paper profits. It didn't really take a palace revolution to put you in the red.

Universal Instruments Corporation has quietly pioneered a different approach to help you combat the stacked deck of import price competition in electronics. We reasoned that if we could take the handwork out of electronic assembly, you could avoid the pitfalls of chasing cheap labor around the world to keep your manufacturing costs down.

Now, computer-controlled automated assembly systems developed and refined by Universal over the past 15 years are providing a better answer to imports—in markets as diverse as color television and seat belt interlock systems.

For example: a flexible complex of Universal sequencers and component insertion machines controlled by worker and supervisory computers adjusts rapidly to meet changes in production schedules at a

major U.S. electronics manufacturer. To keep their plant competitive by turning out 85,000 circuit modules—enough for more than 10,000 color TV sets—per day.

For the new generation of automotive electronics, the Universal In-Line Assembly System can put together circuit boards for digital clocks, anti-skid controls, fuel injection and other devices faster and more economically than any other system. It can assemble approximately 1,260,000 boards per 10-month seven-hour single-shift production year. A production advance that enables electronics and auto makers to meet this high volume demand—profitably—at home.

Then there's the flexible new "Quadraser" that handles circuit boards automatically, computer-controlled wire termination systems, and the "Multiser" system that inserts up to ten components at once. Plus emerging production technology developments from Universal to help make your present domestic production at least as cost-effective as past offshore production. Even in 1985, when U.S. manufacturers will need over one billion circuit boards.

Because we know there's no way except better technology to keep all of us in the electronics business.

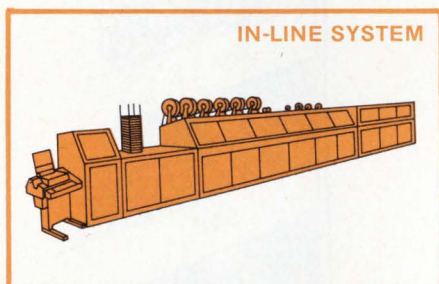

The most cost-effective system available for high volume circuit board production.

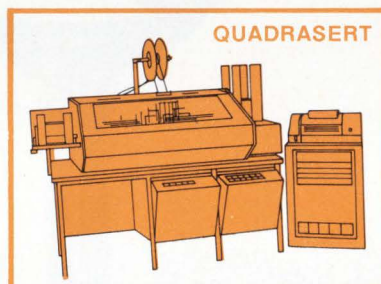

Combining automated board handling with moving table insertion for added flexibility in high volume circuit board production.

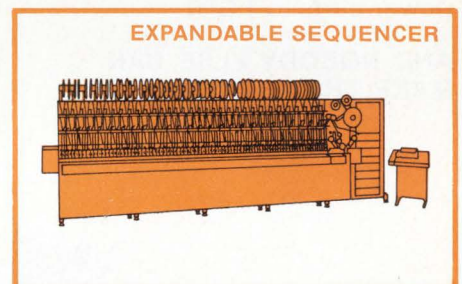

Add-on flexibility from 20 to 95 stations permitting growth without production obsolescence in your component sequencing operation.

Write or call us today for complete technical literature and production specifications on these and other Universal systems—including a wide line of insertion machines, sequencers, and wire wrap systems—as well as information on our extensive contract facilities for electronic assembly.

 **Universal** INSTRUMENTS CORPORATION
P.O. Box 825 / Binghamton, New York 13902
Tel: 607-772-7522 • Twx: 510-252-1990

U.I.C. Sales and Service Offices in California: Santa Ana; Colorado: Denver; Florida: St. Petersburg; Illinois: Palatine; New Hampshire: Manchester; New York: Binghamton; North Carolina: Raleigh; Pennsylvania: Levittown; Texas: Dallas. Also offices in Armegatan, Bombay, Copenhagen, Frankfurt, London, Milan, Montreal, Paris, Sidney, Tel Aviv, Tokyo, and Toronto.

RF transistors like everybody else makes

2N3375	2N5070	2N5641	2N6082	MHW559
2N3553	2N5071	2N5642	2N6083	MHW560
2N3632		2N5643	2N6084	MHW561
2N3866	2N5090	2N5942	MRF304	MHW562
2N3948	2N5109	2N5944	MRF305	MHW709
		2N5945		MHW710
		2N5946		
2N4427	2N5589			
2N4428	2N5590			
	2N5591	2N6080		
2N5016		2N6081		
	2N5635			
	2N5636			
	2N5637			

Most anybody can supply many or most of these popular, tried-and-true RF power devices. Single-sideband, low-band, high-band, VHF, and UHF parts.

And much of the technology that used to be state-of-the-art is now well-known by others as well as us. Balanced emitter technology . . . mesh-emitter structuring . . . spine-emitter geometries . . . SOE configurations . . . even Isothermal* fabrication.

Motorola's got it all.

But only Motorola can supply you with all these "old" parts in nearly any quantity for your designed-in communications gear. Because Motorola is the broadest-line supplier of RF power parts to 1 GHz.

AND NOBODY ELSE CAN MAKE THAT STATEMENT.

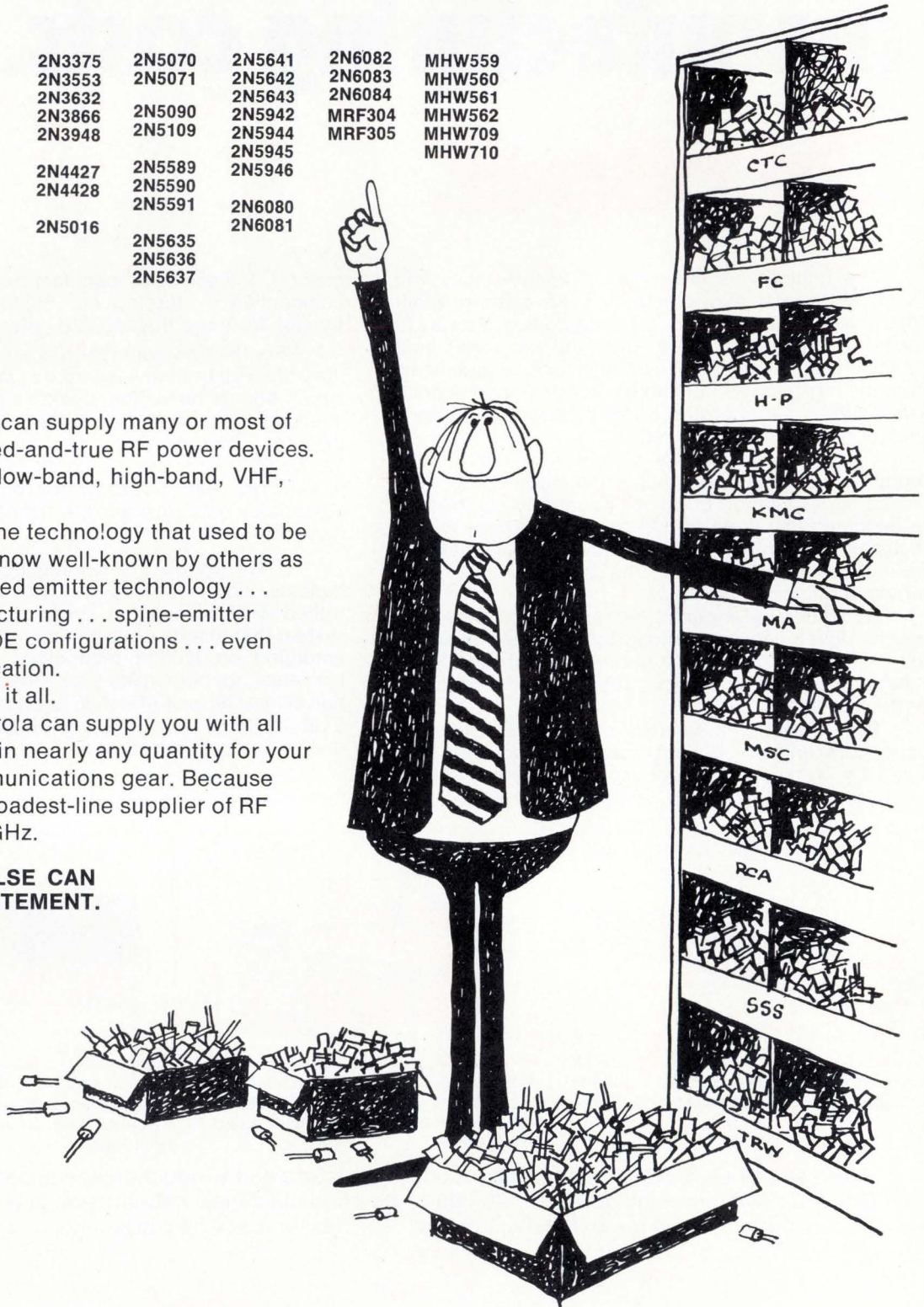

RF transistors like nobody else makes

MRF215 | Controlled Q VHF . . . highest industry gains.

MRF225 | Class E CB devices to 13 watts.

MRF227 | Class E CB, common emitter TO-39 . . . power out 3 watts. Replaces expensive stud.

MRF230 | Complete line of mid-band parts designed with gains for well-behaved circuit performance from 40 to 100 MHz.

MRF511 | State-of-the-art CATV device with the industry's best triple beat performance - 65 dB @ +50 dB MV output.

MRF619 | Industry performance leaders for UHF mobile radio. State-of-the-art leader 45 W (MRF621).

MRF5174 | Highest gain drivers available in the industry for 28 V, UHF military applications.

MRF823 | State-of-the-art 900 MHz, 12.5 Vdc device, common emitter for predictable turn-on characteristics and best stability.

MRF816 | Highest performance single sideband transistors in the industry (MRF420 75 W PEP, 12.5 V; MRF421 100 W PEP, 12.5 V; MRF422 150 W PEP, 28 V). State-of-the-art, unparalleled ruggedness.

MRF306 | State-of-the-art, UHF, 28 V, 50 W gold metallization. High gain, reliable.

MHW410 | 1.5 W, 7.5 V UHF portable module.

MHW601 | High Gain, rugged VHF modules - 20 dB/20 W/12.5 V.

MHW602

Design radios like everybody else . . . or nobody else . . .
Send for RF Design Guide RF-1 and RF Cross-Reference Guide CRF-1 — Box 20912, Phoenix, AZ 85036.
See your franchised Motorola distributor or factory rep.

one and only

From Motorola, the RF producer.

MDA SERIES NOW PART OF

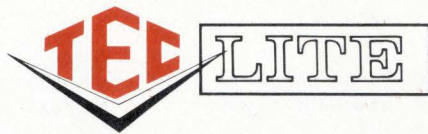

MDA SERIES LED READOUT-DECODER/DRIVER
MODULES NOW GIVE TEC THE
BROADEST LINE OF LED
READOUTS ON THE
MARKET—AT
COMPETITIVE
PRICES PLUS
FAST DELIVERY!

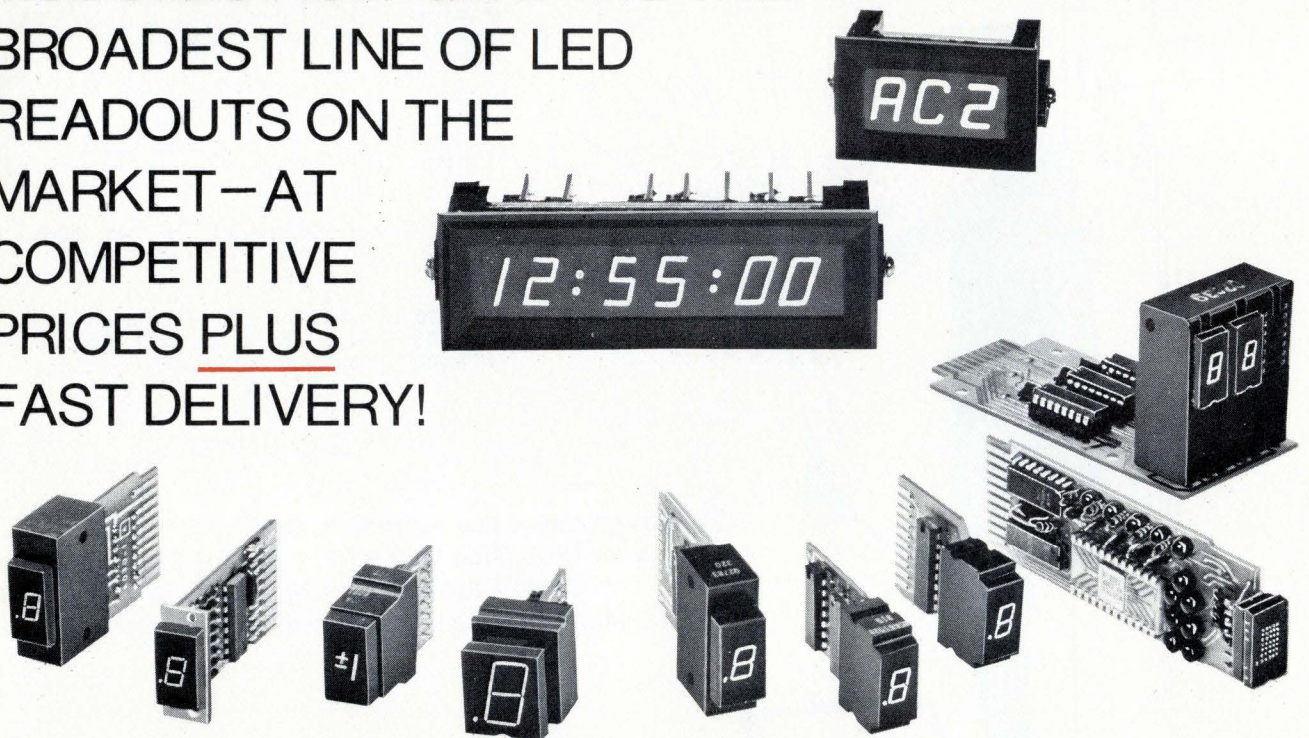

OUR READOUTS NOW INCLUDE:

FULL ALPHANUMERIC ■ LOW-COST
HEXADECIMALS ■ SIZES FROM .27 INCH
TO 1 FOOT ■ RED, GREEN, YELLOW LED'S

*TEC-LITE . . . YOUR COMPLETE SOURCE FOR SWITCHES, INDICATORS
AND INFORMATION DISPLAY/CONTROL DEVICES*



9800 N. ORACLE RD./TUCSON, AZ. 85704 U.S.A./ (602) 297-1111

INCORPORATED

Navelex readies proposals for Fleetsatcom modems

Competitive technical proposals for three classified air, ship, and ground-based components for the fleet satellite communications system will be issued by the Naval Electronic Systems Command within six months. Fleetsatcom program officials at Navelex say the units include **an air-ground digital data modem with five data rates employing biphasic and quadriphase phase shift keying**; a solid-state uhf power amplifier, for use with the AN/ARC 143B radio and other subsystems, that will be able to transmit voice, fm, teleprinter, and high-speed digital data by either satellite or line of sight; and **a pre-detection combiner to transmit or receive signals simultaneously on up to four antennas** mounted on the outer surface of an aircraft.

After demonstrating the production capabilities of the three black boxes, the contractors chosen are expected to receive awards to turn out 100 of the power amplifiers and achieve **a monthly production schedule of 20 each for the digital data modem and the pre-detection combiner**. Industry sources say the combiner is technically challenging since it must combine up to four aircraft antenna signals into one rf output. Adds Navelex, these signals may also be alternately—but not simultaneously—either frequency-modulated or differentially encoded, phase-reversed, with or without phase shift keying.

Computers boost U.S. trade balance in first half . . .

Although exports of all types of U.S. calculators surged to \$104 million in the first half, more than 80% above last year's level, Government statisticians still see computers and associated peripherals as the mainstay in the 54% increase in the country's \$555 million positive trade balance in business machines between January and June. The reason: **computers and related hardware exports rose 36% from last year to \$980 million**, accounting for 74% of total business-machine shipments overseas, while comparable imports slipped 17% to \$54 million. Moreover, the Commerce Department says its **new figures for exports—especially in computers—are higher not because of inflationary price increases but because "advances in technology continue to offset most of the higher labor and material costs."** However, U.S. dominance of the domestic electronic-calculator market is being increasingly challenged by imports, which rose 28% to nearly \$114 million in the first half.

. . . but consumer sales, imports continue down

U. S. consumer electronic product sales to dealers continued to slump in August despite a significant 14.8% increase in home radio sales—led by fm receivers—and a fractional increase in monochrome television sets. New Electronic Industries Association figures put **color TV unit sales for August and the first eight months of 1974, respectively, at 589,489 and 4,917,000, down 16.1% and 6.6% from last year**. Monochrome TV totals of 499,275 and 3,690,000 were up 0.2% for August but down 9.1% for the year so far. Home radio sales are 7.1% below 1973 for the over-all year so far, and auto radio sales 22% below.

Imports of home audio and video electronics also slipped in the first half, according to the Commerce Department. Auto radios proved the only exception, climbing 16% to 2.4 million units, the agency said, reflecting increased offshore production by U. S. makers, notably in Brazil. Dollar value of all consumer electronics imports remained in effect unchanged at \$875.1 million for the half because of price increases.

Comsat chosen to represent U.S. in Aerosat combine

Now that Comsat General Corp. has been selected over RCA Globcom to represent the U.S. in the joint development with Canada and the European Space Research Organization of Aerosat, the final roadblock to choosing hardware for the Atlantic Ocean aircraft communications satellite system has been removed. The first organizational meeting of the combine will be held in October, and **contracts for construction of two satellites and one ground station, targeted for \$90 million, will be "solicited internationally some time in 1975,"** says one Comsat General official. Preliminary satellite designs include experimental vhf capability to accommodate U.S. airlines in addition to the uhf favored by the Europeans. Clauses in the preliminary agreements that permit any partner to withdraw if development costs greatly exceed \$90 million could be a problem if retained, as the FAA estimate was \$150 million plus [*Electronics*, March 29, 1973, p. 41]. If the system is launched successfully, **a new market for L-band avionics will take off in 1977.**

FAA chief pushing U.S. air traffic hardware overseas . . .

A personal sales pitch for U.S. air-traffic-control systems is being made to six nations in Eastern Europe and the newly interested Middle East by Federal Aviation Administrator Alexander P. Butterfield to bolster private efforts and improve the U.S. balance of payments. Though the FAA and a private consultant estimate Western Europe has more than 100 major ATC facilities in need of upgrading, trade rules there favor local hardware makers. Thus Butterfield's current push is limited to **Czechoslovakia, Poland, Romania, Egypt, Iran, and Kuwait.**

. . . while FAA staff shuffling slows R&D

In every area except the politically important one of microwave landing systems, the FAA's electronics research and development is expected to slow down even more as a result of **agency chief Alexander P. Butterfield's inability to get his staff selections approved by the Department of Transportation.** The nomination of FAA planning director Frederick A. Meister, Jr., as associate administrator for engineering and development has been withdrawn because he lacks an engineering background. Gustav Lundquist will continue in that job since his nomination as FAA southern region director was rejected for undisclosed reasons at "the highest level" of DOT, officials say. And this action has in turn blocked the promotion of David Israel, Lundquist's deputy, widely believed by industry to be an alternate selection to Meister.

Treasury backs electronic systems for funds transfer

New interest at the Treasury Department in adopting electronic funds transfer systems to reduce costs of its Social Security and military payroll disbursements was noted by the chief economist of the American Bankers Association at a recent management conference. He predicted that **the transfer of funds at Federal Reserve Bank clearinghouses will increasingly be automated as the use of paper checks grows** from the 26 billion transactions a year to about 40 billion in 1980. The Federal Reserve and the Justice Department have recently enjoined that no bank be prohibited from joining an automated clearinghouse or other electronic funds transfer system developed by a local combine.

**WHAT THIS COUNTRY
NEEDS IS A GOOD**

~~4¢~~ ~~5¢~~
RECTIFIER*



HERE IT IS...GENERAL INSTRUMENT'S 1N4001

***Conditions of Sale**

Minimum Order Quantity: 1,000,000 units scheduled within 12 months

Delivery: Minimum Shipment 100,000 pcs.

Packing: Bulk Packing, 1,000 unit/box

Marking: Cathode Band, 1N4001, GI, Date Code

AQL: 1%

Specifications: Per EIA

For complete information call toll-free 800-645-1247 (In New York State call 516-733-3235) or write, General Instrument Corporation, Semiconductor Components Division, 600 W. John St., Hicksville, N.Y. 11802.

GI'S GOT IT!

**GENERAL INSTRUMENT CORPORATION
SEMICONDUCTOR COMPONENTS**



Europe's microwave equipment makers show space gear at Montreux

Although some of Europe's communications-satellite and microwave projects are still years away, equipment makers are already busy designing the components for them. And much new hardware they have so far readied was in evidence at the current Microwave 74 exhibition in Montreux, Switzerland.

Besides new hardware, the biennial microwave show—the fourth of its kind in Europe—some important trends were revealed. One is a big step toward higher frequencies and efficiencies in such components as traveling-wave tubes. In its latest TWTs with two-stage collectors that AEG-Telefunken displayed efficiency is more than 40%, and the company is developing a TWT with a five-stage collector that will give better than 50% efficiency. Other companies are displaying TWTs that operate at frequencies as high as 40 gigahertz.

Also discernible at Montreux was an advance in solid-state and integration techniques in high-frequency components. Microwave integrated circuits are no longer a new concept, but are about to become workhorse devices in nonmilitary applications. Says George P. Sloots, manager of the microwave-products group of the Elcoma division of Philips Gloeilampenfabrieken, "MICs, too much of a laboratory thing till recently, are now moving from high-brow military jobs into down-to-earth equipment."

Sloots cites microwave solid-state filters, couplers, doublers, triplers, and down-converters—not only for satellite, but also for terrestrial television use. "They are devices with guaranteed performance and life that can be mass-fabricated with high reproducibility." And when Sloots speaks of mass fabrication, he is speaking in terms of 10,000 to 100,000 of some MIC components.

Setting its sights on future satel-

lite- and terrestrial-communications markets, Siemens AG brought to Montreux a line of five new TWTs. Of particular note, a Siemens man says, is the RW1270, designed for Europe's geostationary radio-television satellites of the 1980s. Having a continuous-wave output of 700 watts, the tube operates at 11.7 to 12.5 GHz and has gain of 50 dB. Its delay line is cooled conductively, and the collector's heat is dissipated by a special carbon collector.

What may be considered the terrestrial counterpart of the RW1270 is the RW3010, another high-power TWT from Siemens. It is intended mainly as a power-output stage for satellite ground stations. Operating in the higher Ka band (30 to 40 GHz), the liquid-cooled tube has a minimum output of 1 kilowatt and a gain of more than 43 dB. Total efficiency is more than 30%. A standout in the Siemens line of grid-controlled tubes is the combination TK4500 cavity/YD1381 triode. This twosome will figure in the Marsat maritime satellite project, also dur-

ing the 1980s, in which more than 1,000 ships will communicate to shore stations via satellites. Together with the triode YD1381, the cavity operates in the 1.6-GHz range. The contact-cooled triode has a 100-w output at 2.3 GHz and has a useful life of 10,000 hours.

Philips' main theme at Montreux was, of course, microwave ICs. The company showed that a solid-state parametric amplifier, normally considered very expensive because a klystron is required as a pump source at high frequencies, can now be made at a cost reduction of 50% and with size and weight 50% to 80% below those of conventional units. These reductions result from using microstrip techniques with semiconductors that replace the klystron.

Coupler. Another technical highlight at the Philips stands was a 3-dB coupler. The normal method of making a broad-band 3-dB directional coupler by using two lines with a narrow slot between them is difficult in MIC technology. Philips

Around the world

Laser shows promise for communications

A tiny solid-state laser, built around a special neodymium-crystal compound, requires less than 1 milliwatt of pump energy to achieve light amplification—less than 10% of the energy needed by other solid-state lasers. The material, neodymium pentaphosphate, appears to be ideally suited for a communications role because it remains chemically and mechanically stable at temperatures as high as 400°C and can withstand the high radiation loads of several million watts per square centimeter that are expected in future optical fibers. What's more, a member of the team that developed the laser says that at its wavelength of 1.05 micrometer, optical fibers have minimal losses.

The crystal measures only one-third of a cubic millimeter, which is some 1/30 the size of the crystals used in conventional solid-state lasers. The new laser's energy-conversion efficiency is around 30% in pulsed operation and 2% to 3% in continuous-wave operation. The key to the laser's low pump energy and small size is the neodymium pentaphosphate, which is grown at the Max Planck Institute for Solid State Research in Stuttgart, where the laser was developed. This crystal allows a far greater concentration of optically active ions than, for example, gallium-aluminum-arsenide, neodymium-yttrium-aluminum-garnet, or other garnet materials.

combined a line on one side of the substrate and a slot on the other to build a highly reproducible device. The coupler's insertion loss is as low as 0.3 dB in the C band and 0.6 dB in the X band. Isolation in the new coupler is better than 30 dB over an octave. □

Japan

Injection laser resembles filament

Resembling a filament, the active region of a new buried heterostructure injection laser is only 1 micrometer square. The structure, developed by Toshihisa Tsukada of the Hitachi Ltd. central research laboratory, has a length on the order of 400 micrometer. Advantages of this geometry include reproducible operation at lowest-order modes and a high coupling efficiency into the optical fibers now being developed for optical-communications applications.

Most double heterostructure lasers have had an undesirable dimensional imbalance that confines both the light and carriers in the active region. In general, the width of the active region is 100 or more times larger than the thickness, causing a degradation in the structure's optical properties.

Therefore, it has been impossible to obtain predictable or reproducible transverse modes parallel to the junction plane, even though the lowest-order transverse modes perpendicular to the junction plane have been obtained reproducibly. What's more, coupling to optical fibers has been inefficient.

Tsukada has developed this laser with its width approximately equal to its thickness, which does not introduce new mechanisms of degradation, by completely burying the filamentary gallium-arsenide active region so that it is completely surrounded by gallium aluminum arsenide. This ensures that both light and carriers will be confined in the

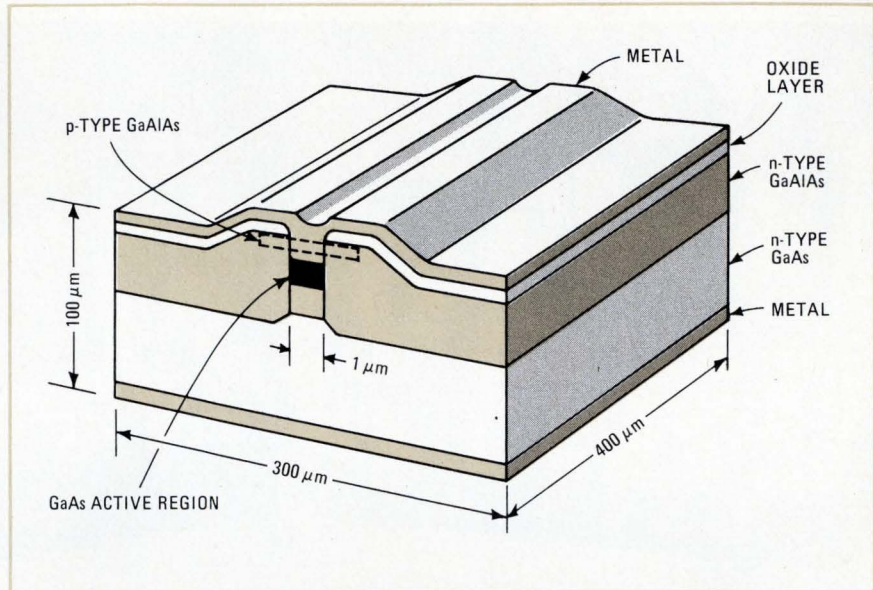

Linear. With a cross-section that measures only 1 micrometer square, the active region of injection laser gives high coupling efficiency.

filamentary active region.

Fabrication of the new laser starts in the same manner as other heterostructure lasers. Successive layers of n-type gallium aluminum arsenide, nondoped gallium arsenide, and p-type gallium aluminum arsenide are grown by liquid-phase epitaxy on an n-type gallium-arsenide substrate.

This step is followed by a mesa etch to produce a mesa about 1 μm wide by the length of the chip. Tsukada uses a deeper mesa etch than others have used and cuts unwanted regions down to the original gallium-arsenide substrate.

It appears to be difficult to start with a mask 6 to 8 μm wide and etch away the epitaxial layers so that a mesa only 1 μm wide remains. But Tsukada says that the process is relatively simple and highly reproducible. In the lab the progress of the etching process is observed, but once the conditions are set, it can be carried out easily as a production process by maintaining the same conditions and time.

Sandwich. In the next step, n-type gallium-aluminum arsenide is again grown on the substrate by a liquid epitaxial process until it reaches the height of the mesa and the active region is completely surrounded. Others have failed in an attempt to

achieve a similar structure because their mesa etch was terminated before it reached the substrate. It is necessary to grow the gallium-aluminum-arsenide epitaxial region that sandwiches the mesa on the original substrate, rather than on an earlier epitaxial layer that has been exposed during the mesa-etch process.

Subsequent fabrication steps include masked p-diffusion into the top of the mesa and immediately surrounding the gallium aluminum arsenide for ohmic contact, opening the contact window, and metalization.

Lasers of this type have been fabricated with active regions smaller than 1 μm square. They operate in the lowest-order transverse-mode pattern with predictable and reproducible performance. The mode pattern is extremely stable and does not change, even with changes of an order of magnitude in the exciting current.

The best performance to date includes continuous oscillation at room temperature with a minimum current of 17 milliamperes, and pulsed operation with a minimum current of 15 mA. These values are about an order of magnitude better than the best performance heretofore achieved. □

Here are two of the world's best oscilloscopes.

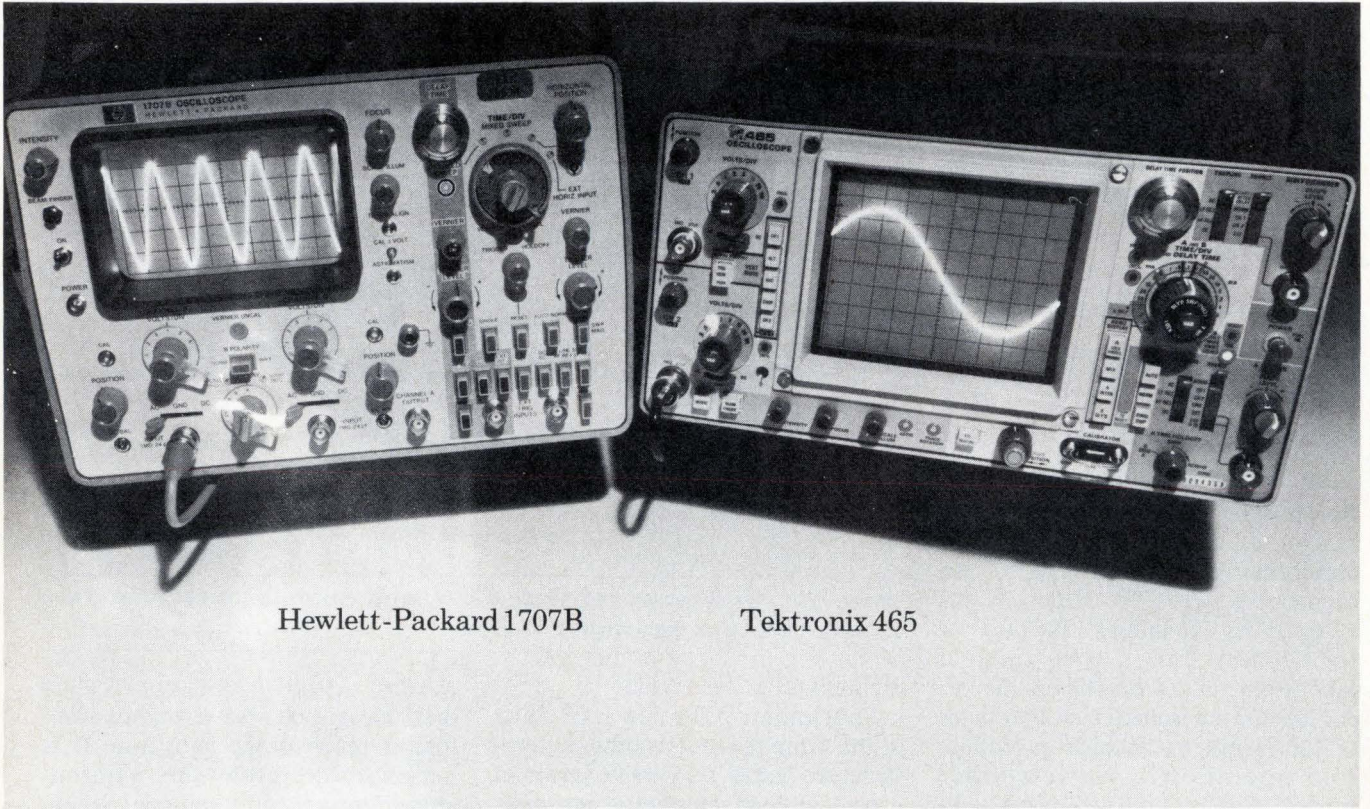

Hewlett-Packard 1707B

Tektronix 465

Here's why you shouldn't own either one.

You can lease one for as little as \$45 per month.

We can give you immediate delivery on either the Hewlett-Packard 1707B or the Tektronix 465, in quantity.

The Hewlett-Packard scope lease is \$45 per month for 36 months. The Tektronix 465 is \$50 per month for 36 months.

Anyway you choose, leasing is the best thing that ever happened to a tight capital equipment budget. You pay for your scope as you use it ... and you pay for it out of the profits it generates.

Call your closest Instant Inventory Center and ask us about short term rentals, delivery, and other lease terms for scopes or any other electronic equipment you need, up to and including minicomputers.



Anaheim, California (714) 879-0561
Dallas, Texas (214) 661-8082
Fort Lauderdale, Florida (305) 771-3500
Gaithersburg, Maryland (301) 948-0620
Burlington, Massachusetts (617) 273-2770
Mountain View, California (415) 968-8845
Oakland, New Jersey (201) 337-3757
Rexdale (Toronto) Ont., Canada (416) 677-7513
Des Plaines, Illinois (312) 827-6670

Rental Electronics, Inc.

A **PEPSICO** leasing company.

International newsletter

Unidata, Philips, Logabax computers bow at Sicob show

Europe's tri-national computer combine—Unidata—starts to flex its muscles as it presents three new machines at the current Paris Sicob EDP show. **The package will include one small office machine produced by Philips and two medium-sized models separately produced by Philips' Unidata partners Siemens and Compagnie Internationale pour l'Informatique.** At the same time, Philips is striking out on its own with a new minicomputer, the P-852M, which will not come under the Unidata umbrella. With a basic speed of 1.5 microseconds, the new machine is compatible with other Philips series 800 models.

But Philips' French rival in the mini-market, Logabax, is launching three new models at Sicob as its own broadside in what is becoming a fierce battle in this model range. Code-named 4300, 4400, and 4600, the Logabax machines, which replace the company's existing minis, have larger central memories and faster processing times. Top of the range model 4600 has a speed of 1.2 microseconds and a memory capacity of between 8 and 32 kilowords. Logabax and the smaller French computer companies are **complaining that Philips is using Unidata as a Trojan horse to invade the office computer market in France**, a move which Philips' competitors claim was forbidden by French government computer planners.

Companies agree to study Europe's 1980s airline market

In a move that could eventually have wide ramifications in European airframe and avionics markets, **six big airplane manufacturers have agreed to study aircraft requirements in the 1980s with Europe's airlines.** The companies involved are: British Aircraft Corp., Hawker-Siddeley, Aerospatiale, Dornier, MBB, and VFW/Fokker. Whether or not the study will eventually lead to actual aircraft remains to be seen. But the agreement is significant for a number of reasons. For one, it is the first time that the companies have agreed to such a move. For another, it recognizes that a European collaboration may be the way to beat rising costs of new airliners. What's more, it may provide the vehicle by which the Europeans overcome U.S. hegemony in the airframe market. **Significantly, the agreement encourages other European companies to join, which is seen as a move to discourage joint projects with U.S. companies.**

Three European companies coordinate microprocessor sets

Three semiconductor producers—AEG-Telefunken, SGS-Ates and General Instrument Europe—have each developed mutually compatible sets of MOS large-scale-integration microprocessor circuits. About to go to market as standard devices, “they are the first truly European-made microcomputer circuits to be offered,” says Klaus E. Bomhardt, head of development at AEG-Telefunken's semiconductor facilities in Heilbronn.

Significantly, compatibility is achieved even though each company has taken a different approach in MOS manufacturing technology. While the West German firm uses aluminum-gate, double ion-implantation techniques, Italy's SGS-Ates employs silicon-gate MOS, and GI Europe, also headquartered in Italy, uses aluminum-gate nitride methods. All circuits are eight-bit p-channel versions, and the technologies involved in making them reflect the respective companies' strengths in MOS

manufacture. The p-channel route was chosen because of the economy this technique offers.

The circuits are now in the pre-production stage and **first applications will be in a microprocessor system built by Olympia Werke AG, an AEG-Telefunken subsidiary.** The system, CP3-F, is a table-top calculator-printer that will come off Olympia's production lines in Braunschweig next year. Talks with other potential circuit users are already being held.

Such project-oriented cooperation in MOS LSI circuitry, says Richard Epple, development coordinator at Heilbronn, is an answer to the demand by most European circuit users for a second or third source. "But it is also an answer to the challenge posed by the American dominance in MOS technology—a dominance underlined by the fact that more than 40 companies in the U.S. are active in the MOS field."

Computer speeds survival assessment after heart attacks

A British research team has developed a computerized system of electro-encephalography—monitoring the brain's electrical activity to detect damage—which speeds assessment of a patient's chances of survival after a cardiac arrest. **The London Hospital survival predictor uses a minicomputer to process assigned numerical values of standard EEG graphs and present them as meter readings.** A clinician may switch among 13 variables to obtain a discriminant function analysis of brain damage caused by lack of oxygen during heart stoppage. A Digico Ltd. Micro 16 minicomputer is used.

Litton to market Adler data systems in U.K. and U.S.

In a move designed to strengthen its hand in the business data-processing market, Litton is marketing its Adler TA1000 in the U.K. and **plans to market the highly successful German system in the U.S. under its Automated Business Systems label.** The modular system will sell between \$10,000 and \$100,000 and is aimed to compete with units made by Burroughs, IBM, NCR, and Singer, among others. First U.S. versions will be designed for accountants, and others, general-purpose systems will follow. Production of the system, introduced in 1973, by Triumph-Adler in Germany currently is about 150 units per month.

The U.S. Federal Trade Commission is expected to rule shortly on Litton's **petition to reconsider the decision that the company divest itself of the Triumph/Adler division on antimonopolistic grounds.** Litton feels, however, that it will take years for the issue to be ultimately resolved.

Marconi lands award for UK 6 satellite

A contract for the design of UK 6, a projected scientific satellite to study gamma radiation in 1977, has been awarded to Marconi Space and Defence Systems Ltd., which is expected to get a follow-on construction contract. **In a switch from usual British practice, Marconi, as prime contractor, will supply the electronics, while British Aircraft Corp. will build the spacecraft under subcontract.** Marconi also built the 300-pound UK 5, to be launched in October [*Electronics*, Sept. 5, p. 34], for a cost of about \$7 million. The Ministry of Defence procurement executive made the award for the Science Research Council.

Design for 300° C with Carborundum Ekkcel™ thermoplastic

And mold with standard injection equipment

Few thermoplastics can retain long-term performance at temperatures of 300° C (572° F). Ekkcel can. Ekkcel is the only thermoplastic that can be easily molded on standard injection molding equipment and also resist these temperatures. That's important to you — because you're interested in both the performance of a material and the costs of molding.

Ekkcel performs . . .

A wide variety of high-performance electrical and mechanical components are being designed and molded in Ekkcel. Ekkcel has extremely low moisture absorption, good friction and wear, outstanding electricals, very high radiation and chemical resistance, and superior flammability resistance — Ekkcel satisfies Underwriters Laboratory specification VE-O.

Combine these properties with excellent dimensional stability and strength up to 300° C, and you have



Ekkcel, an exciting thermoplastic for most any electrical and mechanical design.

The other half: moldability . . .

Ekkcel molds on standard injection molding equipment. So you don't have to worry about expensive special molding equipment. Ekkcel resin runs easily, so you get high production rates — even with difficult-to-mold designs. You can also regrind Ekkcel — and that means lower costs.

What's your application?

If you have an application requiring performance at high temperatures, tell us about it. Contact Tracy O'Rourke, General Manager, High Performance Plastics, The Carborundum Company, P.O. Box 337, Niagara Falls, New York 14302. (716) 278-2441. Carborundum Ekkcel. It lives up to its name.

Effect of Heat Aging on Tensile Properties of Ekkcel I2000

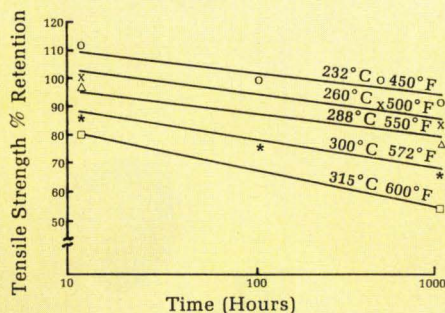

Rate of Weight Loss vs. Time Ekkcel I2000

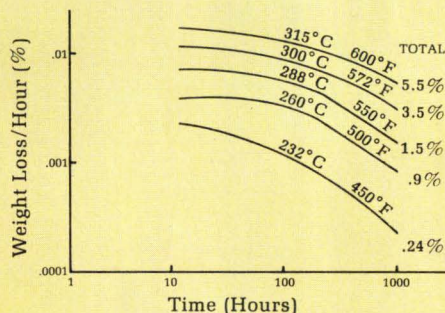

CARBORUNDUM

Circle 59 on reader service card

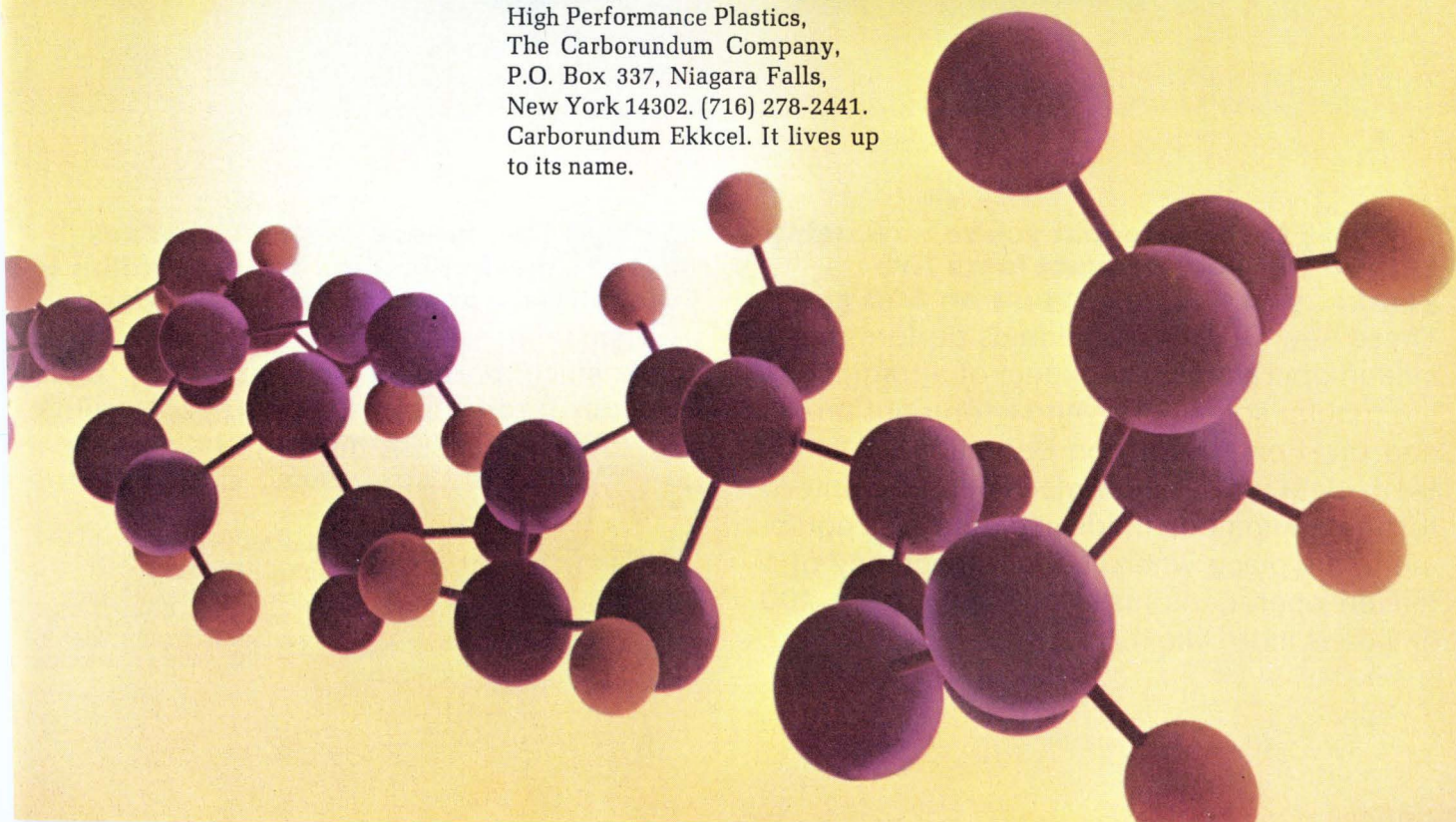

Your Guardian Angel
(and dramatic engineering
developments) bring you

solenoids



NEW! If the solenoid you're now using in your product lasts five years... you can now figure on 500 years.

These new Guardian solenoids perform the 1 million operations you expect of a traditional-life tubular solenoid . . . and keep right on . . . and on. For 100 million operations. Making them ideal for business machines, computers, testing equipment, medical electronics equipment, anyplace where a life expectancy of 1 million operations just won't do. Where 100 million is more like it.

NEW! This unique design increases mechanical life from 1 million to 100 million... at just a little more cost.

The amazing part is how little more cost for so much more life! Only about 25% more than our traditional-life tubular solenoids. Yet you get 10,000% more life! The secret is in the cost saving design of the new steel shell.



Get all the long-life facts.

in this brand new 72-page Guardian Solenoid Catalog. It's proof Guardian's No. 1 in solenoids... and plans to stay there.

that last 100 times longer*

*And that's a minimum. Life tests have already gone past 100 million operations ...and are still running!

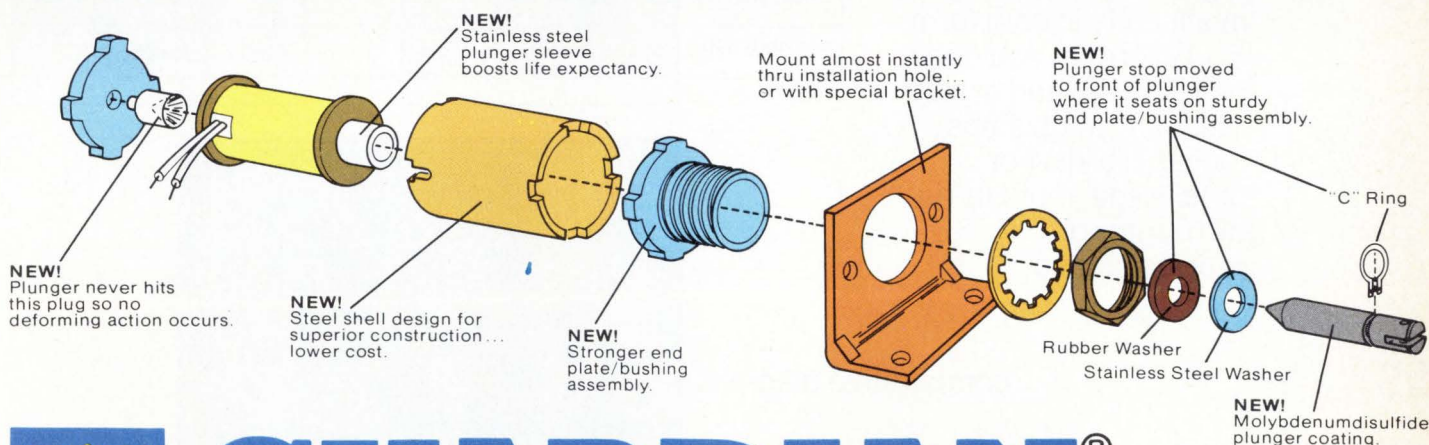
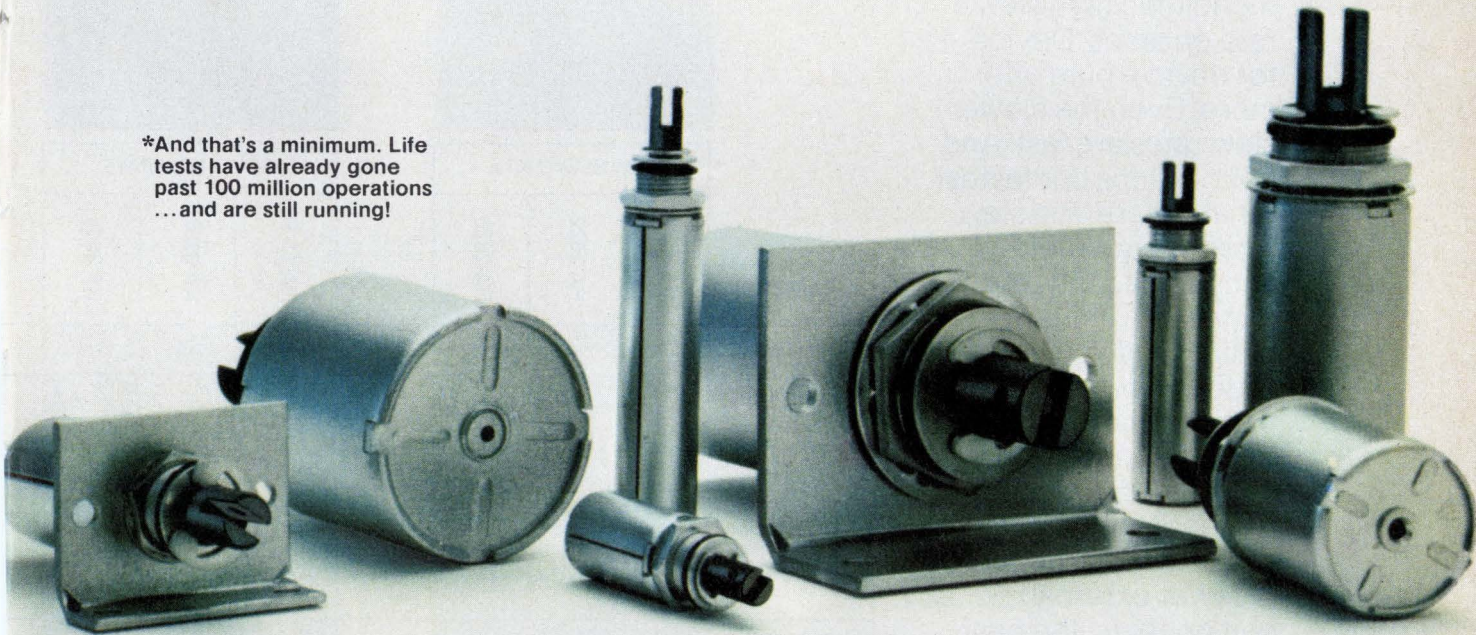

GUARDIAN®

GUARDIAN ELECTRIC MANUFACTURING CO. • 1566 West Carroll Ave., Chicago, Illinois 60607

Circle 61 on reader service card

Our family of high the broadest and fast

Here's proof.

Compare the performance characteristics of these monolithic high slew rate op amps. Device for device, ours offer more. Even the slower slew rates are fast. And nobody tops our fastest. What's more, the slew rates are guaranteed and tested. And where bandwidth limits are critical and you need wide bandwidths at high output levels, these are the op amps for you.

Other advantages are better settling times; space savings because of fewer external components; the best possible DC performance at the highest speeds; and availability in chip form. So, wherever you need high speeds and greater reliability in op amps, look to Harris. For details see your Harris distributor or representative.

PRECISION
NON-COMPENSATED
5V/V GAIN STABLE

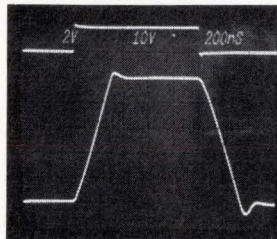

INTERNALLY COMPENSATED
UNITY GAIN STABLE

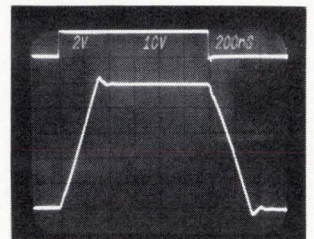

PARAMETERS	LOW SLEW RATE			LOW SLEW RATE		
	HA-2620	HA-2622	HA-2625	HA-2500	HA-2502	HA-2505
Slew Rate	± 25	± 20	± 20	± 25	± 20	± 20
Full Power Bandwidth	400	320	320	350	300	300
Gain Bandwidth Product	100	100	100	12	12	12
Settling Time	1000	1000	1000	330	330	330
Voltage Gain	100k	80k	80k	20k	15k	15k
Bias Current	15	25	25	200	250	250
Offset Current	15	25	25	50	50	100
Offset Voltage	4	5	5	5	8	8
100-999 Units	\$14.95	\$8.95	\$5.95	\$18.50	\$12.95	\$7.50

comparative diagram

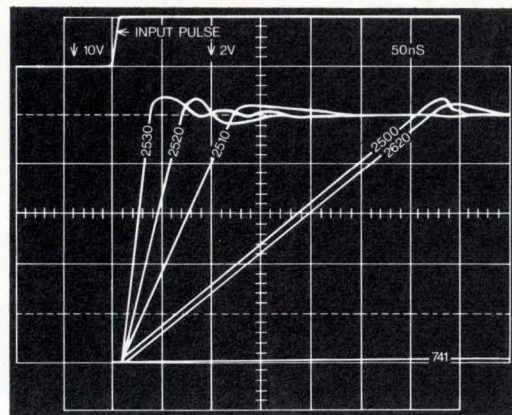

Slew rate op amps is best in the industry.

NON-COMPENSATED
3V/V GAIN STABLE

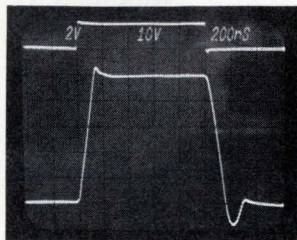

NON-COMPENSATED
3V/V GAIN STABLE

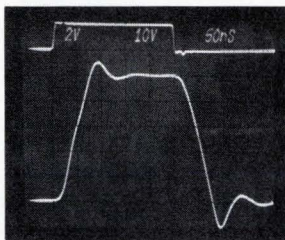

NON-COMPENSATED
10V/V GAIN STABLE
INVERTING ONLY

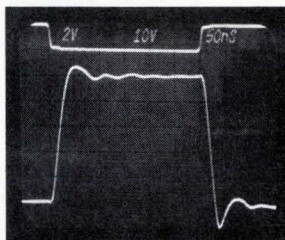

MEDIUM SLEW RATE

HIGH SLEW RATE

VERY HIGH SLEW RATE

MEDIUM SLEW RATE			HIGH SLEW RATE			VERY HIGH SLEW RATE		
HA-2510	HA-2512	HA-2515	HA-2520	HA-2522	HA-2525	HA-2530	HA-2535	UNITS
±50	±40	±40	±100	±80	±80	±280	±250	V/μS (MIN)
750	600	600	1500	1200	1200	4000	4000	kHz (MIN)
12	12	12	20	20	12	70	70	MHz (TYP)
250	250	250	200	200	200	500	500	ns (TYP)
10k	7.5k	7.5k	10k	7.5k	7.5k	100k	100k	V/V (MIN)
200	250	250	200	250	250	100	200	nA (MAX)
50	50	100	25	50	50	20	20	nA (MAX)
8	10	10	8	10	10	3	5	mV (MAX)
\$18.50	\$12.95	\$7.50	\$18.50	\$12.95	\$7.50	\$33.00	\$14.30	



HARRIS
SEMICONDUCTOR
A DIVISION OF HARRIS CORPORATION

P.O. Box 883, Melbourne, Florida 32901 (305) 727-5430

WHERE TO BUY THEM: ARIZONA: Phoenix—Hamilton, Liberty, Weatherford; Scottsdale—HAR (602) 946-3556 CALIFORNIA: Anaheim—Weatherford, El Segundo—Liberty, Glendale—Weatherford, Long Beach—HAR (213) 426-7687; Mountain View—Elmar, Palo Alto—Weatherford, HAR (415) 964-6443; Pomona—Weatherford; San Diego—Liberty, Weatherford COLORADO: Commerce City—Elmar, Denver—Hamilton, Englewood—Weatherford CONNECTICUT: Danbury—Schweber, Norwalk—Harvey FLORIDA: Hollywood—Hamilton, Schweber, Melbourne—HAR (305) 727-5430 GEORGIA: Atlanta—Schweber, Norcross—Hamilton ILLINOIS: Elk Grove Village—Schweber, Schaumburg—HAR (312) 894-8824; Schiller Park—Hamilton INDIANA: Indianapolis—Pioneer KANSAS: Lenexa—Hamilton MARYLAND: Baltimore—Hamilton, Rockville—Schweber MASSACHUSETTS: Burlington—Hamilton, Lexington—Harvey, Wellesley—HAR (617) 237-5430 MICHIGAN: Livonia—Hamilton, Troy—Schweber MINNESOTA: Medina—Hamilton, Schweber; Minneapolis—HAR (612) 432-6111 MISSOURI: Hazelwood—Hamilton NEW JERSEY: Cedar Grove—Hamilton, Mt. Laurel—Hamilton, Somerset—Schweber NEW MEXICO: Albuquerque—Hamilton, Weatherford NEW YORK: East Syracuse—Hamilton, Melville—HAR (516) 249-4500; Syracuse—HAR (315) 463-3373; Rochester—Schweber, Westbury—Schweber, Woodbury—Harvey NORTH CAROLINA: Raleigh—Schweber OHIO: Beachwood—Schweber, Cleveland—Pioneer, Dayton—Pioneer, HAR (513) 226-0636 PENNSYLVANIA: Wayne—HAR (215) 687-6680 TEXAS: Dallas—Hamilton, Weatherford, HAR (214) 231-9031; Houston—Hamilton, Weatherford UTAH: Salt Lake City—Hamilton WASHINGTON: Seattle—Liberty, Weatherford WASHINGTON, D.C.: HAR (202) 337-3170 CANADA: Mississauga, Ontario—Hamilton; Montreal, Quebec—Hamilton; Ottawa, Ontario—Hamilton

LEGEND FOR HARRIS SALES OFFICES & DISTRIBUTORS: Elmar Electronics (Elmar); Hamilton Avnet Electronics (Hamilton); Harris Semiconductor (HAR); Harvey Electronics (Harvey); Liberty Electronics (Liberty); Pioneer Standard Electronics (Pioneer); Schweber Electronics (Schweber); R. V. Weatherford Co. (Weatherford).

Beckman Instruments

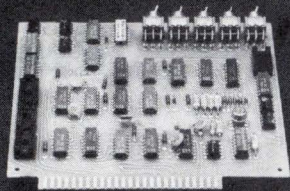

CalComp/Century Data Division

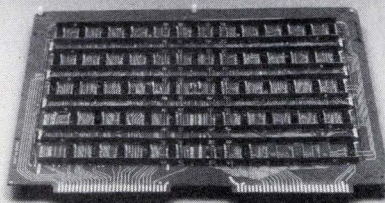

Litton Digital Data Systems

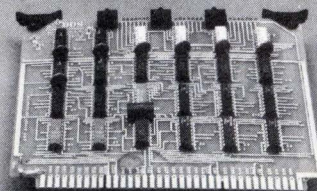

Lexitron

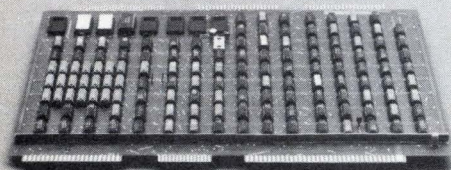

North Electric Company

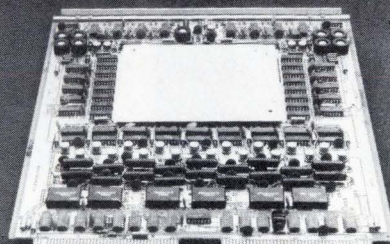

Western Electric Company

(Board not released for photography.)

Econolite

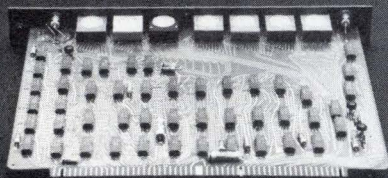

Data Source

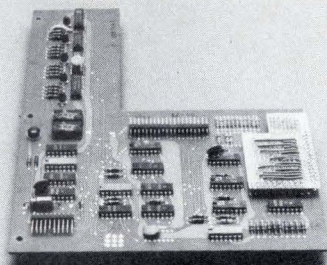

Diablo Systems Incorporated
A Xerox Company

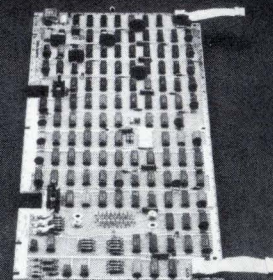

COMPUTER AUTOMATION'S AUTOMATIC TESTER HAS

We've listed a few of our CAPABLE tester customers simply to point out something obvious. Companies like these don't buy sophisticated hardware just on the name. Which is a good thing because how many people have ever heard of the CAPABLE tester, anyway?

The fact is, you can't solve testing problems with a name - big or otherwise. So these companies did just what you would do. They looked at all the automatic board testers available. And then they picked our CAPABLE.

The reason is faster board throughput. High-speed, high-volume fault detection and isolation across the entire board range. From simple

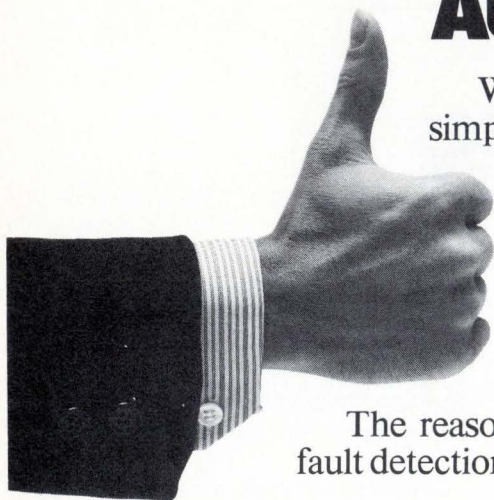

Collins Radio Company

(Board not released for photography.)

TRW Data Systems

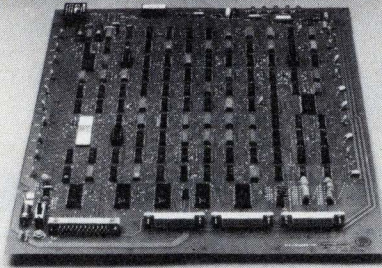

Rockwell International

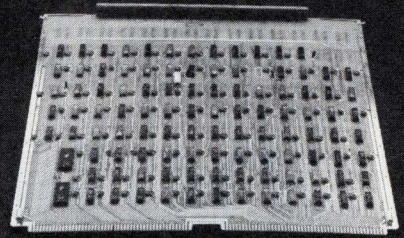

Diebold, Inc.

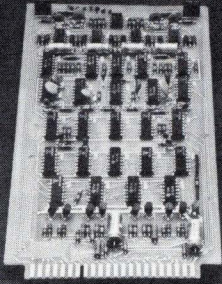

Tally Corporation

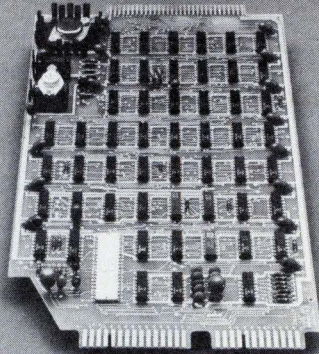

Computer Machinery

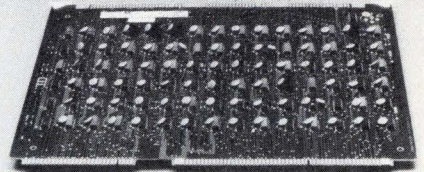

Ampex Corporation

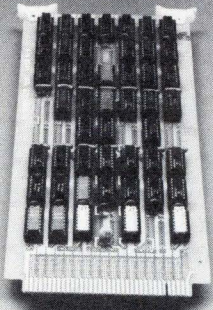

GTE/Information Systems

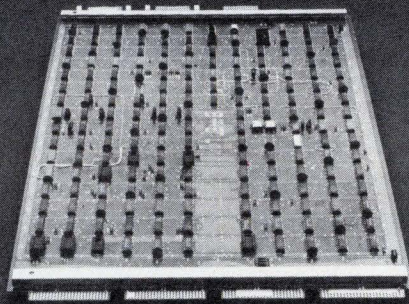

National Cash Register

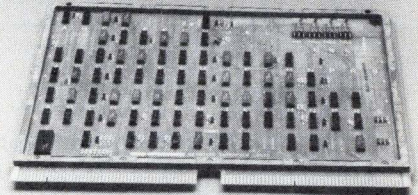

ACROSS THE BOARD APPROVAL.

to complex modules. Digitals to hybrids. With incredible ease of operation.

And here's the payoff. Actual in-use figures show that CAPABLE can pay for itself in as little as 12 months. Even less in some cases.

If you're more interested in profits than prominence, we can help you now. Later on we'll throw in a big reputation.

18651 Von Karman, Irvine, California 92664, (714) 833-8830



CA ComputerAutomation
Industrial Products Division

Bellevue, Washington, (206) 455-9650 / San Jose, California, (408) 247-2026 / Broomfield, Colorado, (303) 466-1749 / Orlando, Florida, (305) 857-0100 / Elk Grove Village, Illinois, (312) 956-6400 / Cleveland, Ohio, (216) 692-1965 / Massapequa, New York, (201) 825-0990 / Watford, England, Watford (0923) 39627

Circle 65 on reader service card

“Throughput? We push 700 bare boards a day through each of our N151’s.”



Paul Costello, QC Manager
General Circuits, Inc.
Rochester, N.Y.

General Circuits became one of the largest PC board manufacturers in the country by never letting up on product quality. And the man most responsible for that quality is Paul Costello, QC Manager.

So when Mr. Costello went looking for a high-speed test system for his bare boards, he knew what he wanted: reliability, throughput, and system support. He chose a Teradyne N151: “We liked the speed, the easy connection, and the fact that anyone could operate it. We were also impressed with Teradyne’s ability to look after the mechanical fixturing and give us a turnkey solution.”

GC now has two N151’s, each testing up to 700 boards a day using more than 600 programs stored on magnetic tape. Since the systems are completely self-programmed, they are operated by employees with absolutely no technical background.

Typical of the products tested is a 3700-point four-layer board produced for a leading computer manufacturer. GC’s 1920-point N151’s handle these in two 15-second passes, one for each half of the board.

But what really boosts throughput is the N151’s fast setup. All circuits can be tested after just two connections. Costello comments: “Testing reliability is so high we’ve been able to eliminate visual inspection, and our return rate has been reduced by a factor of 15.”

GC’s N151’s are off the air for maintenance only about two hours a week. And as for support, Costello says: “Teradyne gives us better support than any company we’ve ever dealt with.”

Sound interesting? For full details, write Teradyne, Inc., 183 Essex St., Boston, Mass. 02111. In Europe: Teradyne Ltd., 12 Queens Road, Weybridge, Surrey, England.

TERADYNE

CHICAGO (312) 298-8610 / DALLAS (214) 231-5384 / NEW ENGLAND (617) 458-1256 / NEW YORK (201) 334-9770 / SUNNYVALE (408) 732-8770
LONDON (0932) 51431 / PARIS 265 72 62 / ROME 59 47 62 / MUNICH (0811) 33 50 61 / TOKYO (03) 406-4021

Probing the news

Analysis of technology and business developments

Instrument makers seek a language

Meeting in Bucharest, aimed at establishing a universal bus standard, is studying communications rules initiated by H-P

by Stephen E. Grossman, Instrumentation Editor

As instruments almost daily acquire more capabilities, there has been a quickening clamor for a common language so they can "talk" to each other. That's what the International Electrotechnical Commission has set out to accomplish this week (Sept. 18-20) in Bucharest, Romania.

The proposition before the IEC's Technical Committee 66 is worldwide instrument bus standardization. Initiated by Hewlett-Packard Co., Palo Alto, Calif., but supported by other instrument makers, the proposed standard is a design for a universal communications link for all instruments and peripherals—computers, voltmeters, card readers, spectrum analyzers—without regard to manufacturer or nation of origin. The document defines the roles of the various interconnecting wires, the physical connector, timing, logic conventions, and the format of control signals and data signals, plus other factors necessary for compatibility.

As H-P's Don Loughry sees it, having a common interface definition makes it much more practical for both manufacturers and users to put systems together. Loughry was the principal architect of the proposal. "It means that design engineers won't have to spend a lot of time inventing interfaces for each new product," he says. "If you can indeed standardize on a common interface, this in turn should reduce manufacturing cost. [And if the user] sees devices from a number of different manufacturers, all with the same interface, then it should reduce both his learning curve and his support problems." Finally, says Loughry "if the languages that you

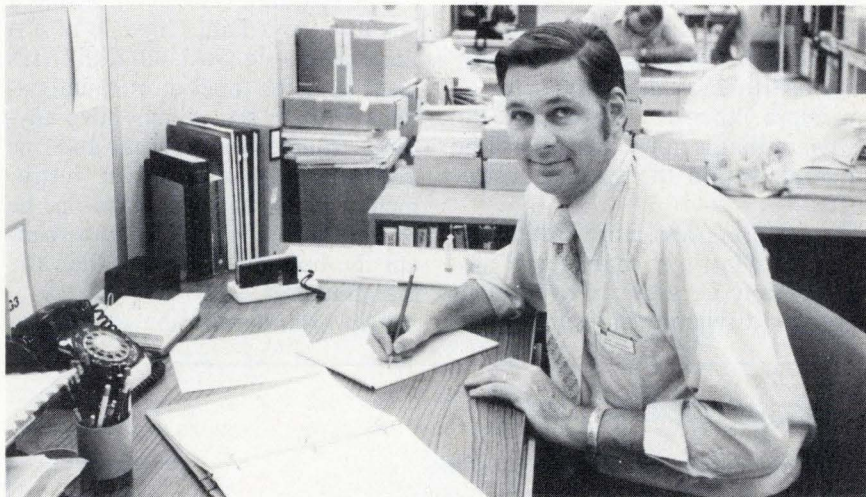

Linguist. H-P's Don Loughry was main architect of proposal for common language.

communicate to and from the instrument are similar in many respects, this tends to reduce cost of software efforts."

In a hurry. Robert Fulks, president of Mirco Systems Inc., Phoenix, Ariz., and chairman of the U.S. standards committee, says, "We've gone through the standard proposal enough times that we're pretty happy with it," adding that the firms involved have "forced ourselves to agree. We have to have the standard pretty soon." Fulks says that H-P has been helpful and flexible and has not tried to impose its wishes arbitrarily on anyone.

In general, the proposed standard has fairly strong support among instrument makers. At Wavetek Corp., San Diego, Calif., project engineer Peter Silvernail says his company "is positively and wholeheartedly in favor of the IEC standard," though he adds that he's not very excited about some parts of it, particularly those affecting the

connector. Like Fulks, he praises H-P's great cooperativeness, which he says has undoubtedly helped acceptance of the standard.

Wavetek is already making instruments with the proposed IEC standard interface, notably its models 158 and 159 multiphase generators and its model 152 function generator [*Electronics*, Aug. 22, p. 133]. Silvernail points to a specific advantage of the standard with respect to Wavetek's business: "People will be able to use our \$1,500 function generator with calculators rather than turning to \$8,000 synthesizers made by other firms."

Don Leahmer of Systron-Donner Corp., Concord, Calif., sees the data-bus standardization scheme as a means of opening up the industry competitively but not as something that will be adopted totally by the industry for at least five or six years.

Once the standard is in effect more or less generally, many com-

Probing the news

panies will lose money for a while, says Leahmer, but soon they will make up for it with an expanded market due to interchangeability of parts. "On the one hand they will lose their captive customers," he says, "but on the other, they will gain customers from competitive systems who will be able to shop around."

Leahmer expects no direct cost savings to the user. "Rather, it will be a shift in costs," he says. "The bus will make it cheaper to build a system, but it will also make the specific instruments that attach to the bus more expensive. Essentially, the software that is now external will be internal, within the specific instrument."

Some users are more optimistic. John S.J. Harrison, manager of system design at RCA's Government Systems division in Burlington,

Mass., believes a standard data bus would enable the company to connect instruments and computers a lot more economically. "In the preliminary stages of design, when you're looking at peripherals you haven't utilized, you have to estimate what it will cost to connect them," he says. "What falls through the crack is the cost of interconnection." Without this knowledge it's too easy to underestimate or overestimate cost, and a standard bus could allow users to get a better handle on this, he adds.

The standard can't be viewed as a panacea, says Paul Goodale of E-H Laboratories in Oakland, Calif. "It's very good for small to medium systems," where a user may have anything from one instrument and one controller up to a dozen instruments. Differing with Harrison, he expects bus standardization to benefit the user more directly than the manufacturer.

"Any standardization at all is a

good thing," according to John Fluke Jr. of John Fluke Manufacturing Co. in Seattle. "The only criticism I have of the IEC criteria is that they don't go far enough." As Fluke sees it, three levels of standardization are necessary if there is to be a truly complete interfacing of instruments:

- Hardware interface standardization, where there is agreement on voltage levels and "hand-shaking" techniques, and similar nuts and bolts problems.

- A common unit of information.

- A common mode of sequencing information.

H-P's Loughry sums it up by saying, "We have got to walk before we run and do what is practical and feasible. As we gain more experience in standardization, then some of the operational characteristics that are common to all devices will become a little more obvious—and then we can go ahead and finish the job." □

Equal opportunity

The standard bus system is very democratic—it lets a device change its role from "talker" to "listener" to controller in just milliseconds.

Each device ties on in parallel to three buses. The data bus transfers both data and addresses among the devices in a bit-parallel, byte-serial fashion. The transfer bus controls the transfer of data on the data bus. The control bus performs various control functions; for example, it channels a service request (SRQ) from a device needing to attract the attention of the controller, and it also handles the remote enable (REN) instruction that tells a device to respond to remote programming rather than its own.

As the illustration shows, in any data transaction each device assumes just one of the three listening, talking, or controlling roles. Here, a calculator programs devices B, C, D to perform the first two jobs. It then programs a signal generator (listener) for a chosen signal frequency and amplitude, which is applied to a unit under test (UUT). The output level is measured by the measurement instrument (talker) which passes on the measurement value to the digital recorder (listener). Simultaneously, the data can also be entered into the calculator.

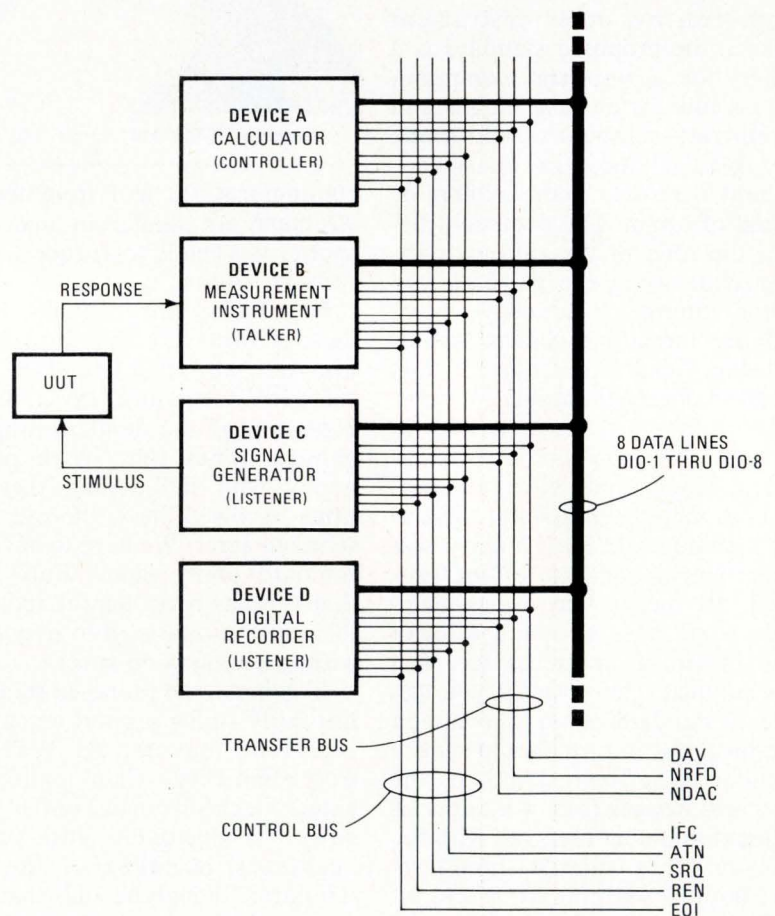

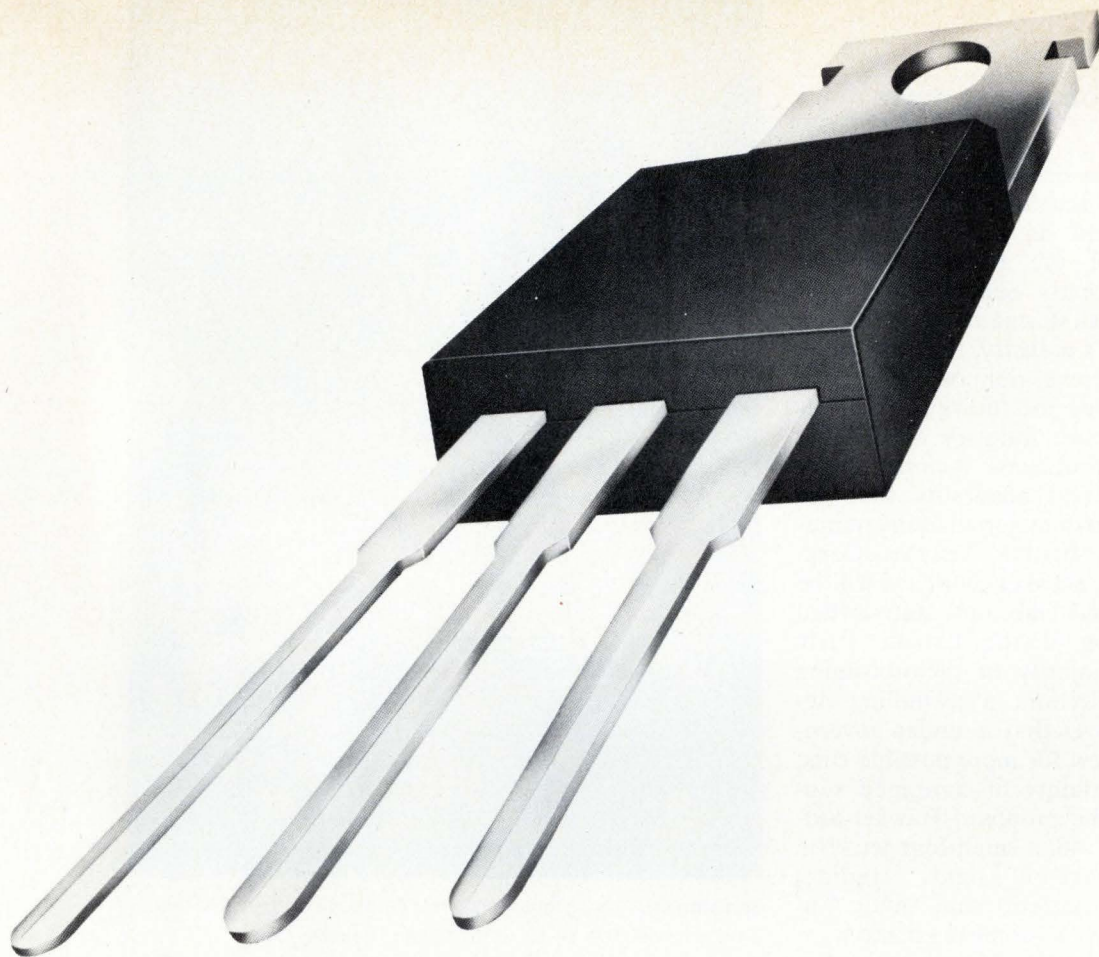

The RCA 300 volt Triac. It can knock the 400 volt triac right out of the box.

The RCA T2800C is a solid 300 volt, 8 amp. triac. And sets a whole new standard for the industry. Until now, if you wanted added protection for 120V line operation, you were forced to go from 200 volts all the way up to 400 volts. More protection than you needed. More price than you should be paying. Matter of fact, right now there are a lot of black boxes containing 400 volt triacs that could easily have used the RCA T2800C, 300 volt device.

It's rugged enough to handle just about any 120V line job you have in mind or that's 'on the boards'—from motor controls and solid state relays to power switching systems. It has features like: glass passivated junction, 100 A peak surge full-cycle current rating, shorted-emitter center-gate design, low switching losses, low thermal resistance and it comes in our rugged Versawatt package. Perfect for dependable operation in a 120 volt line non-consumer environment.

Another important feature is that you "buy it off the shelf" either from your local RCA distributor or directly from RCA Solid State.

Its 1K price is 96¢—sufficiently lower than the 400V device to save you money while still playing it safe.

T2800 FAMILY

RCA TYPE	VOLTAGE RATING	1K PRICE
T2800B	200V	\$0.88
T2800C	300V	0.96
T2800D	400V	1.04
T2800M	600V	1.50

For more information contact your local distributor or RCA Solid State, Section 70119, Box 3200, Somerville, N.J. 08876. Phone (201) 722-3200, Ext. 3134.

For a free sample, send RCA a note under your company's letterhead stating the application.

RCA Solid State

International: RCA, Sunbury-on-Thames, U.K., or Fuji Building, 7-4 Kasumigaseki, 3-Chome, Chiyoda-Ku, Tokyo, Japan. In Canada: RCA Limited, Ste. Anne de Bellevue 8 10, Canada.

Probing the news

Against an economically uncertain backdrop, the British aerospace industry held its first international edition of the Farnborough Air Show in early September, and if weather can dramatize the situation of Britain's industry, the dark rainy cloud cover was right on cue.

Muddying the future of the British aerospace industry are several internal problems. Among them: the very real possibility that the country's two major airframe manufacturers, British Aircraft Corp. (BAC) and Hawker-Siddeley, will be nationalized into one state-owned corporation if the Labour Party wins a majority in the upcoming general election; a dwindling defense budget that is under government review for more possible cuts; and uncertainty of continued support for the proposed Hawker-Siddeley HS-146, a small four-jet STOL (short take-off and landing) "feeder" transport that would appear to have a promising market.

Airline slump. Internationally, British airframe and avionics suppliers share with other countries increased competition for traditional markets while foraging for new buyers. A slump in the airline industry adds problems, too.

Since avionics makes up about a third of the cost of an average aircraft, suppliers of radars, communications equipment, airborne computers, and other electronic aerospace gear face tough going. An executive with a U.S. avionics company declares there is "an oversupply of suppliers" in most of the countries fighting for available markets. Assuming survival of the fittest, he freely admits that "everyone's riding it out, hoping others will drop out."

British avionics suppliers also fear that some of them might be candidates for nationalization. Demurring on that point, M.I. Dodd, sales manager for avionics with Plessey Avionics and Communications, indicates that success might be a matter of carefully choosing markets. While acknowledging the threat of nationalization and the tough competitive atmosphere, he's optimistic



Showing off. Among radars shown at Farnborough was this Plessey S-band model, the AR-15/2, for civil and defense roles.

Electronics abroad

Gloom blankets Britain's air show

At Farnborough, too many avionics makers compete for too few customers

by William F. Arnold, London bureau manager

because "we sell in the right end of the market" with vhf-uhf communications equipment.

Despite the climate, export-conscious British companies put on a bright face during the show. BAC announced the most lucrative orders: sales of Rapier surface-to-air missiles to Oman for \$112 million and to Iran for an undisclosed amount, which includes possible joint production of a tracked mobile version; and an agreement totaling \$200 million with Oman and Ecuador for Jaguar jets BAC is jointly producing

with the French Dassault-Breguet combine. Rapier export sales now amount to \$422 million, BAC boasts.

New or evolutionary electronics technology was prominent in the exhibits of radars, communications equipment, control systems, airborne computers, and guidance systems that took much of the space among stands also showing landing gear, seats, and metallurgy. Overall, more than 400 companies from 10 countries had exhibits, including more than 200 British and 98 American. More than 50 types of aircraft

When RCA says its 2023-12 GIGAMATCH delivers 12 watts at 2.3 GHz, 12 watts is what it delivers.

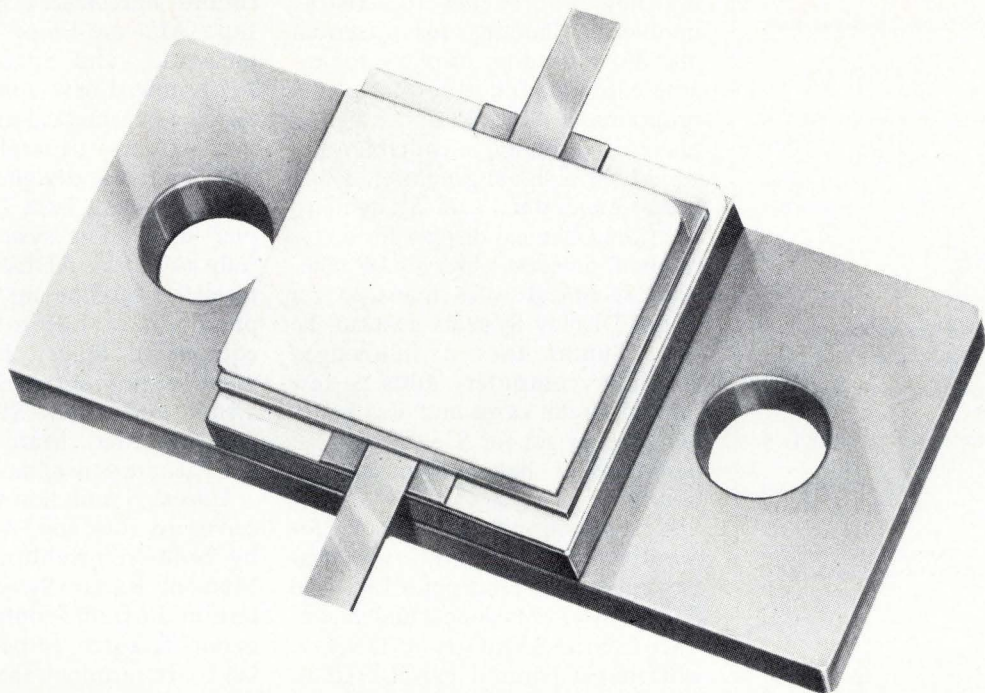

That's technology you can use.

If 12 watts is what you need at 2.0 to 2.3 GHz, 12 watts is what you're going to get. Because at RCA we're working to make our technical leadership important to your product's performance. And to you.

For example, we've used our experience on epitaxial and overlay emitter-electrode construction technologies to bring you the RCA 2023-12. It's internally matched for use in amplifier applications in the 2.0 to 2.3 GHz range.

The RCA 41044 discrete transistor is another case in point. Here's an RF power oscillator that delivers 350 milliwatts of power at 4.3 GHz.

At that frequency, that's a lot of performance.

And that's just the tip of the iceberg.

Last year, we announced 18 families and 29 types of products in the RF power area. Products such as the RCA 2000 and the RCA 3000 series. A new family of 2-GHz and 3-GHz microwave power transistors. A series in inventory, in quantity, and ready to ship.

This year, it's more. We've recently announced the RCA 2310 discrete transistor. We believe this device offers the highest power output for a single transistor to date (10w min.) for S-band telemetry service at 2.2 to 2.3 GHz.

And more is on the way.

In the high power microwave area, we're working on L-, S- and C-

bands. Our line of GIGAMATCH devices (transistors with built-in input and output matching) is being expanded to cover the following additional frequency bands: 0.6-1.0 GHz, 1.2-1.4 GHz, 1.4-1.7 GHz, 1.7-2.0 GHz and 3.6-4.2 GHz.

All these devices will be usable at the frequencies and power outputs specified. So when you think of RF power devices that live up to their specifications, RCA should come to mind and you should contact your local RCA Solid State Distributor.

For data on new microwave transistors write RCA Solid State, Section 70119, Box 3200, Somerville, N.J. 08876. Phone (201) 722-3200 Ext. 3435.

RCA Solid State

A power house in RF transistors

MINI- AND MICROCOMPUTERS SEMINAR

Seminar Chairman: A. C. Knowles, Digital Equipment Corp., Maynard, MA

Monday and Tuesday, October 28 and 29

Commonwealth Ballroom of the Sheraton-Boston Hotel

9:30 am, Monday

S-1 DEVICE TECHNOLOGY

Chairman: W. H. Roberts, Western Digital Corp., Newport Beach, CA

LSI-16/THE WORLD'S FIRST 16 BIT SOS MINICOMPUTER — L. E. Taylor, General Automation, Inc., Anaheim, CA

A HIGH PERFORMANCE, MICROPROGRAMMED, NMOS-LSI PROCESSOR FOR 8- AND 16-BIT APPLICATIONS — Z. Soha and W. B. Pohlman, Western Digital Corp., Newport Beach, CA

MOTOROLA M6800 MICROCOMPUTER/AN ARCHITECTURE DESIGNED FOR EASE OF USE — T. H. Bennett, Motorola Semiconductor Products, Inc., Phoenix, AZ

4K RAM SYSTEM DESIGN CONSIDERATIONS — J. E. Coe, Mostek Corp., Carrollton, TX

2:00 pm, Monday

S-2 MAIN FRAME AND COMPUTER TECHNOLOGY

Chairman: E. D. Crockett, Hewlett-Packard Co., Cupertino, CA

THE TECHNOLOGY OF THE COMPUTER — C. G. Bell, Digital Equipment Corp., Maynard, MA

AN OVERVIEW OF MAJOR MINICOMPUTER PERIPHERALS — R. J. Daniel, Hewlett-Packard Co., Cupertino, CA

GOING REAL-TIME WITH PEOPLE/TERMINAL TRENDS AND PRODUCTS — J. A. Wolaver, Digital Equipment Corp., Maynard, MA

TRENDS IN MINICOMPUTER SYSTEMS AND SYSTEMS SOFTWARE — E. D. Crockett, Hewlett-Packard Co., Cupertino, CA

9:30 am, Tuesday

S-3 INDUSTRIAL APPLICATIONS

Chairman: A. T. Devault, General Automation, Inc., Anaheim, CA

BUILDING MANAGEMENT SYSTEMS — J. H. O'Connell and D. M. Priestley, RCA, Burlington, MA

A PROCESS CONTROL LANGUAGE FOR MICROPROCESSORS — L. H. Anderson, COMSTAR, Edina, MN

PRACTICAL CONTROL APPLICATIONS FOR MICROCOMPUTERS — A. Raynaud, R2E Microcomputers, Orsay, France

MULTI-TASK EXECUTIVES/AN APPROACH TO MICROPROCESSOR APPLICATION SOFTWARE — P. Roybal, National Semiconductor Corp., Santa Clara, CA

2:00 pm, Tuesday

S-4 SCIENTIFIC APPLICATIONS

Chairmen: E. Kramer, Digital Equipment Corp., Maynard, MA

LABORATORY AUTOMATION — D. Glover, Digital Equipment Corp., Maynard, MA

MINICOMPUTER APPLICATIONS IN CHEMISTRY/THE PRESENT AND A LOOK INTO THE FUTURE — D. Dix, Dow Chemical, Wayland, MA

THE NORTHEASTERN UNIVERSITY HIGH ENERGY PHYSICS DATA ACQUISITION SYSTEM — W. Faessler, Northeastern Univ., Boston, MA

MICRO- AND MINICOMPUTER APPLICATIONS IN BIOMEDICINE — A. Gottmann, MD, Metropolitan Labs, Denver, CO

REGISTRATIONS REC'D BY OCT. 15TH

IEEE Members \$80 Non-Members \$99

REGISTRATIONS REC'D AFTER OCT. 15TH

IEEE Members \$95 Non-Members \$125

Registration fee includes one copy of the Seminar Proceedings and free registration to general program and exhibits.

Mini-Micro

Name _____

Address _____

Checks payable to: NEREM-74

31 Channing St. Newton, MA 02158

72 Circle 72 on reader service card

Probing the news

were shown, including the new Hawker-Siddeley Hawk jet trainer and the McDonnell-Douglas F-15 Eagle. The Soviet Union was conspicuously absent.

While fighting for markets, avionics makers showed they are exploiting new approaches to existing hardware. Shooting for a retrofit market in head-up displays, for example, Smiths Industries unveiled a programable "Flexihud" for fighter planes. Normally, a suitable unit would use a signal generator, a ballistics computer, and a standard electromechanical display for a cost of about \$50,000, observes J.R. Caldwell, technical sales manager for Flight Display Systems. Instead, he says, Smiths uses a full-fledged weapons computer, adds a few printed-circuit cards and a cathode-ray tube to get for \$35,000 what it maintains is better than conventional units.

A new radar, the Searchwater, for maritime-patrol aircraft, was displayed by EMI Electronics Ltd. The Searchwater, developed under contract from the Ministry of Defense, will enable Nimrod patrol craft to spot periscopes. The development should set up EMI to compete in a growing international market in sea-patrol radars.

Litton Systems Canada Ltd., which started production of an AN/APS-503 helicopter-borne sea-search radar for Canada, and Ferranti, which is offering a cutdown

Stalker version of its Royal Navy Seaspray, both showed their maritime units. Cossor Electronics, leader in secondary surveillance radars, unveiled new Identification Friend or Foe (IFF) gear and a new portable monitoring unit to check the accuracy of ground-based radar beams.

On the navigation and communications side, Decca Navigator Co. Ltd., Marconi-Elliott Avionic Systems Ltd., and Sperry Gyroscope (UK) showed new units. Decca produced a new tactical-aircraft navigation system a general-purpose digital computer designed to operate with the Decca Type 71 and 72 doppler navigation systems, and the fully automatic ADL-81 Loran-C/D receiving set—the first in the company's new Loran-80 series of equipment. Sperry had an automatic airborne Omega navigation system and a new SRC-200 flight-data recorder. Marconi displayed the Tacan teactical navigator.

Unreal. Simulation technology received its due, too, with new units by Solartron-Schlumberger, and Marconi Radar Systems. The Solartron air-traffic-control radar simulator features a new interactive keyboard-terminal that enables an instructor to give instructions directly to a computer without his having to be a computer programmer. Marconi's Tepigen (for television picture generator) employs a digital computer to generate detailed color or monochrome images on a television screen without the use of models or television cameras. □

On its way. Blowpipe, a British surface-to-air missile for unit defense against low-level attack, goes to work. Made by Shorts Brothers of Britain, it also is to be used by Canada.



FOR NEW STANDARDS IN SPECTRUM ANALYZERS, THINK HP

Tracking generators for wide dynamic range, swept frequency response measurements.

8556A Tuning Section, 20 Hz—300 KHz, with built-in tracking generator, \$1975

8553B Tuning Section, 1 KHz—110 MHz, \$2650.

8443A 110 MHz Tracking Generator/Counter, \$3925.

8444A 1300 MHz Tracking Generator, \$3150.

The Widest Choice in Spectrum Analyzers.

With HP's neatly-interrelated spectrum analyzers, you choose tuning sections, displays and companion instruments to tailor a system for your measurement needs all the way from 20 Hz to 40 GHz. Then, as your requirements expand, re-configure your system simply by adding the related piece of equipment. For example, when you need to cover a new frequency range simply add that tuning section.

By themselves, any of the 4 spectrum analyzers give you tremendous signal analysis capability made possible by absolute amplitude calibration, low distortion, high resolution, and wide frequency scans coupled with the ability to zoom down to a narrow scan.

Value really multiplies when you add the companion instruments. For example, the tracking generators combined with the analyzers make swept measurements over a 120 dB range thus forming precision swept frequency test systems.

And our automatic preselector for the microwave tuning unit does away with virtually all image, multiple and spurious responses.

All in all, HP's family of spectrum analyzers gives you the greatest depth and breadth of performance and the best value in signal analysis equipment available anywhere. For more information, call your local HP field engineer or write.

8554B Tuning Section, 0.1—1250 MHz, \$3700.

8555A Tuning Section, 10 MHz—40 GHz, \$6750.

8445B, 18 GHz Automatic Preselector, for wide scans, free from unwanted responses, \$2370. (\$3040 with LED frequency readout option.)

HEWLETT *hp* PACKARD

Sales and service from 172 offices in 65 countries.
1501 Page Mill Road, Palo Alto, California 94304

8552B High Resolution IF Section has 10 Hz bandwidth, manual scan, two log plus linear scales, \$3275. Lower cost unit (8552A, \$2575) also available.

141T Variable Persistence and Storage Display Section. Gives bright, high-resolution traces at slow scans, \$2035. Also available: economical normal persistence and large screen displays.



It's this way. Ernest, at left above, says "You've got to have a skill."

Probing the news

Manpower

Unlocking a source of technicians

Fairchild, IBM, and H-P sponsor year-long course at San Quentin prison; the 24 enrolled inmates and company sponsors hail classroom innovation

by Judith Curtis, San Francisco bureau

Class begins shortly after supper—at around 6:30 or 7 p.m.—in a dingy, concrete-floored classroom. Open toilets, a water fountain, a green chalkboard, and a yellowing poster reading "Prevent Accidents" provide the decor. Old coffee cans serve as ashtrays. The instructor wears brown pants, a white shirt, and a tie; the students all wear regulation blue shirts and blue jeans.

The course is electronics technology, held four nights a week, four hours a night, at San Quentin prison near San Francisco. After 100 applicants were screened, 40 were chosen, and 24 remain.

The course took one and a half years to jell because of the need to win approval from the state Depart-

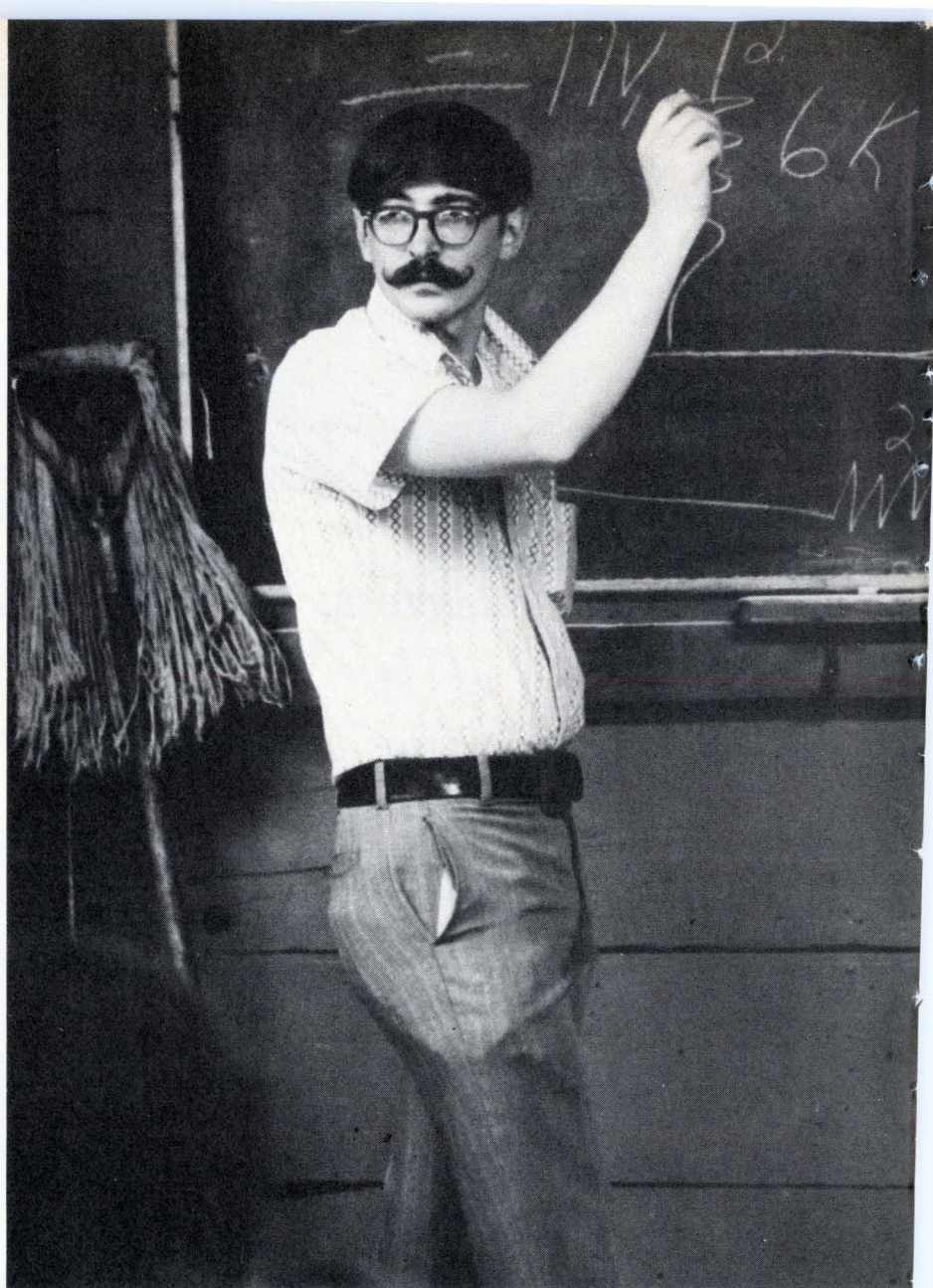

ment of Corrections and to persuade electronics manufacturers to donate the \$50,000 worth of oscilloscopes, voltmeters, and other equipment needed to help teach the students. However, most of the basics—like breadboards and passive components—haven't arrived yet.

The equipment donated so far by the participating companies—Fairchild Camera & Instrument Corp., Hewlett-Packard Co., and IBM Corp.—has been mostly oscilloscopes and voltmeters—gear that's too sophisticated for this stage of the course. Breadboards, power supplies, resistors, diodes, and transistors have yet to reach the classroom. Roger Barney, Fairchild personnel director, admits the problems were

caused by a lack of organization in the beginning. "We probably haven't been as involved as we should have been," he says. "We're going back now to scramble" for those needed tools.

But in any event, to the students the course is a ticket to normalcy. To Ernest, a 39-year-old prisoner scheduled to leave next June, the one-year course, begun this past June, is "going to put me and my family together. I won't have to wait six to seven months for a job or go on welfare when I get out."

It is also a sort of insurance to the electronics firms that put the course together because they will have the pick of the graduates for their technician-short industry.

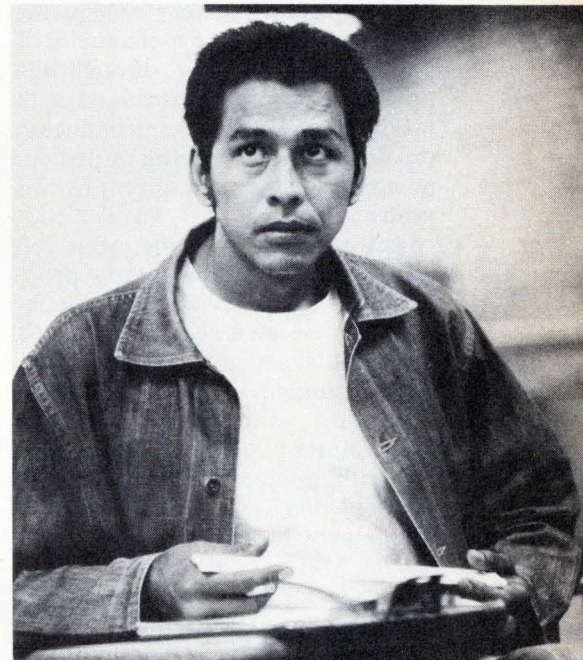
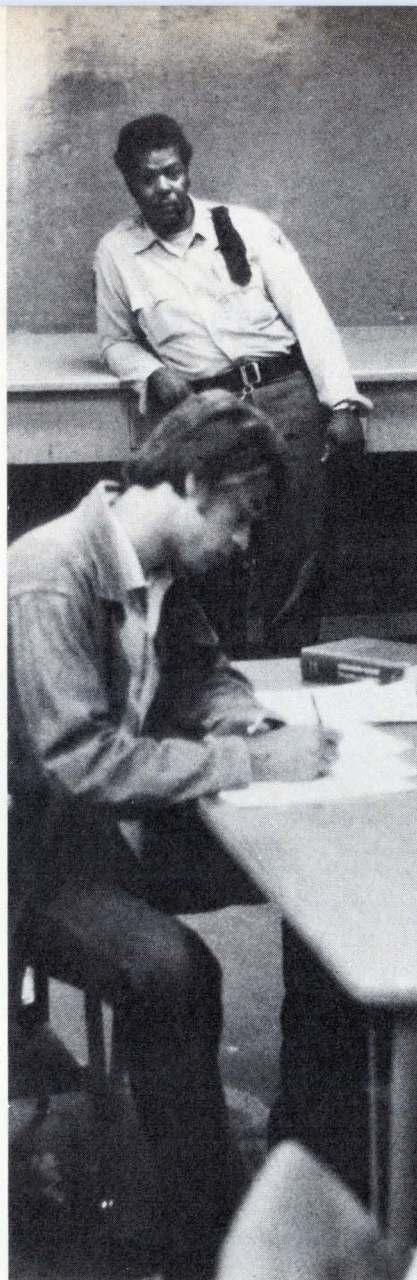
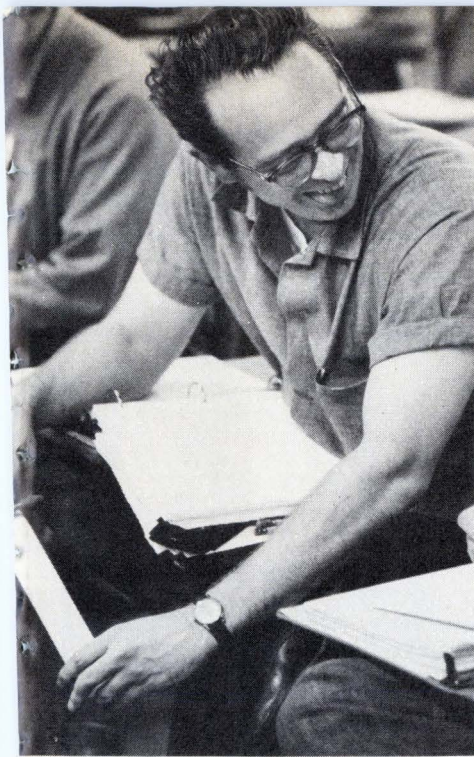

Behind the walls. Counterclockwise from left: instructor Jack Nelson makes a point; student Lavaster smiles because "this gives me an opportunity to have a trade;" Joseph concentrates in the hope that "I won't be back again;" Joseph wonders how much weight the San Quentin course will carry with the parole board—"A lot depends on how I do," he says; Isaac dreams of the day when he can own a business. "I've always wanted to fix TVs and radios but I never gave myself the time to do it. I hope I really get wound up in this."

Sponsors. It all started when Robert Padgett of IBM in Sacramento invited Barney to take a look at the prison vocational program through a tour sponsored by Scope, the Special Committee on Parolee Employment. Barney got the idea that training the men while in prison, rather than after they got out, would benefit the participating companies, as well as the prisoners.

Barney admits that formation of the class, which at Bay Valley Technical Institute, another sponsor, would cost about \$2,000 in tuition, was not totally altruistic. "Our motives were selfish," he says. "There is a social angle and a selfish business angle." In San Quentin, he points out, "there is a group of people

being wasted, and we have a tremendous need for technicians." Barney connected the two ideas, and started the ball rolling.

Jack Nelson, the class instructor, is an enlisted electronics technician at the Navy's Treasure Island base. Prison officials and others participating chose an instructor from the Navy base because it is near the prison, and it's well stocked with instructors. San Quentin pays Nelson's \$5,000 annual salary.

Nelson, more than anyone in the program, has the responsibility for his men. And when working tools, like pliers and screwdrivers, become available, he will be in charge of their use—and liable for their misuse. But he has lost the fears that he

had on his first night teaching the class at San Quentin. That night, he says, "I expected to see Lon Chaney walking around and machine guns. Now, I've never felt safer than when in my class: if anything happened, they would take care of me."

Future. But most of all, the prisoners have gained the confidence that they can take care of themselves when they get out. The reason, claims Joseph, 28, is "that when you go to prison, they don't teach you about a job. That's why I keep up ending up in the joint."

To Carl, who has four more years to serve, the class offers a great chance for a career, rather than just a job. "It's got more of a professional feel to it," he smiles. □

Memories

The 4-k RAM is on schedule

Early production travails are just part of the game, makers contend, as they gird their loins for coming marketing and price battles

by Howard Wolff, Associate Editor

Don't shed any tears for the makers of the sometimes troubled 4,096-bit random-access memory. For as the manufacturers of the n-channel MOS part work their way through the problems normally associated with production of a new semiconductor, the dribble of parts being turned out now should swell to a torrent by this time next year.

But some users have been left disappointed by those early problems. Perhaps convinced by the enthusiastic oversell that has become a semiconductor industry trademark, such customers as Hewlett-Packard Co. and peripherals maker Datapoint of San Antonio, Texas, found themselves scurrying for substitutes when Texas Instruments had problems with its 4-k process [*Electronics*, March 21, p. 70].

Such disappointment came even though knowledgeable observers had said early in the year that output of 4-k RAMs for 1974 wouldn't total much more than 100,000 units [*Electronics*, Jan. 10, p. 100]. That this figure will be surpassed is more a credit to technological knowhow than to a new conservatism on the part of semiconductor marketing men.

The manufacturers know that the start-up problems they've encountered are to be expected. They recall that the ubiquitous 1,024-bit 1103, announced about five years ago, took about two years to get into high-volume production. That timetable puts the 1103's 4-k cousin right on schedule. And the manufacturers also know that when volume production of the 4-k is started by a few leaders, it will be extremely difficult for the others to turn out enough

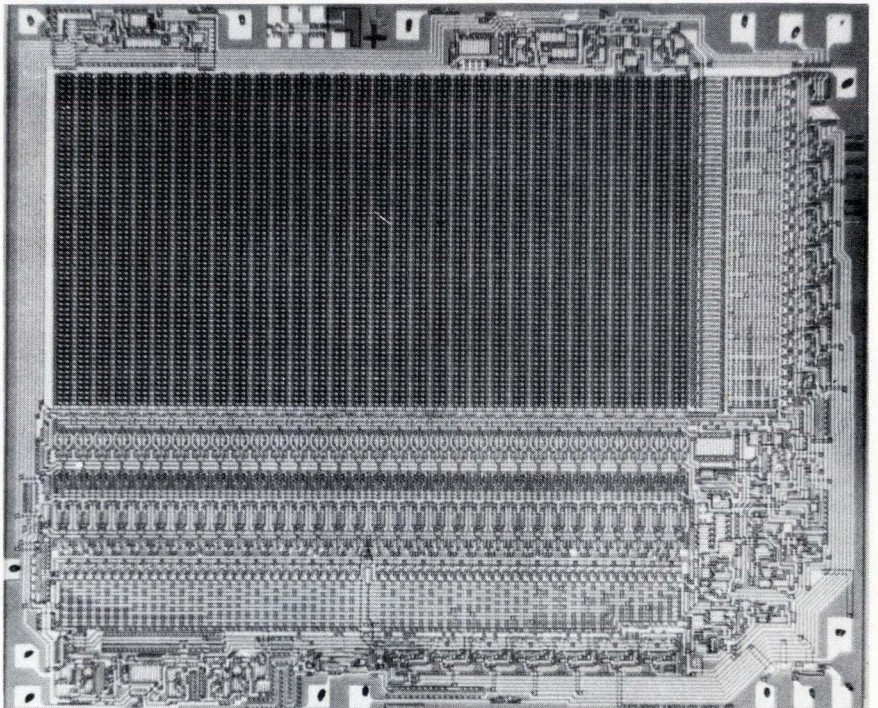

parts to keep up with price cuts and still make a profit.

Industry experts predict that from all this will come a gradual increase in output, coupled with falling prices. Volume is expected to increase for the next 18 months from 900,000 or a million units selling for \$15 to \$20 this year until a few surviving manufacturers will produce 25 million or more parts in 1976 and charge only \$6 to \$8 for them.

Waiting for those prices and volume production are computer mainframe houses. At the moment, 4-k RAMs are finding their way mostly into minicomputers and peripherals. However, as Control Data Corp.'s Tony Vacca says, "It must get below about \$8 in volume production" to compete with the 1-k RAM now sell-

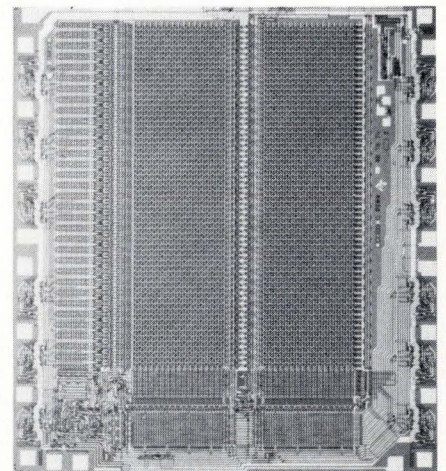

Remembering. The 4-k RAM comes in two pin configurations: the 16-pin version, such as Mostek's (top), and the 22-pin, an example of which is the Texas Instruments chip that is shown above.

The inside story of the company inside your products.

AVX is the major supplier of ceramic capacitors and EMI filters. Components you use inside your systems and subassemblies.

Our inside story is quality. Quality built into all our components through technological leadership in ceramics and metal-

lization. Through advanced design in packaging. Through painstaking manufacturing and thorough testing at every stage of the production cycle.

Quality that lets you forget all about us once you've built our components into your products.

To remind you of all the components and subassemblies we offer, we've packed them into two new catalogs. Fill in the coupons on the following pages to order your catalogs and get the complete AVX story.

AVX: The Insiders.



Where can you find a remote controlled cassette tape transport for under \$100?

For years, designers have been waiting for a high quality tape transport at a reasonable cost. Now the Phi Deck has arrived, the first American-made transport with features like complete remote control, quick head engagement, no tape coasting, battery or AC current operation, a capability for digital or analog signal recording and standard or non-standard speeds. But the features don't stop there. It can play a C-120 cassette with ease, has the fastest stop-start speed of any deck of its kind on the market, and because it has four separate motors, can be equipped to electronically sense the status of the tape, preventing any tape damage, ever. And the price is under \$100 even if you buy just one. There are so many uses for a transport with this flexibility, it's a wonder someone didn't think of it before.

HERE!

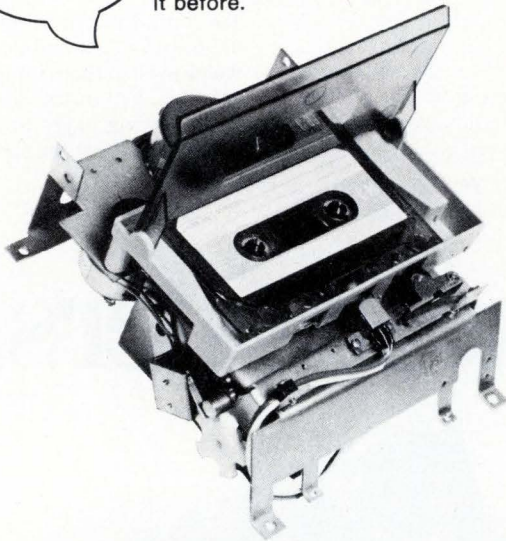

PHI-DECK A PRODUCT OF I.I.I.

An affiliate of The Economy Company, Educational Publishers
Oklahoma City, Oklahoma 73125

Call, write, or send the coupon to: C

Individualized Instruction Incorporated
1901 N. Walnut
Oklahoma City, Oklahoma 73105
(405) 528-8444 Ext. 76

Please send me more information about
PHI-DECK.

Name _____

Address _____

City _____ State _____ Zip _____

Probing the news

ing for \$2 to \$5. Vacca, manager of the System Electronics department in CDC's Advanced Design Laboratory, adds, "The \$3 to \$4 range makes it extremely attractive, and this price isn't out of the ballpark for the 1976-77 time frame, major suppliers have indicated to us." Vacca says that some of CDC's divisions will be building 4-k RAMs into peripherals and small computers next year. "But just because of the inertia and the time it takes to get a big computer into the marketplace," he adds, 4-k won't show up in mainframes until later in the decade. "We've begun to design with the 4-k in mind," says Vacca, "and will be picking candidates next year."

The Minneapolis-based computer maker is concerned, not only about price, but also about reliability. "None of the suppliers has done a reliability study," says Vacca, "If we believe the numbers they quote, and if we apply those numbers to a system, it wouldn't run more than a few minutes. Reliability is the top concern of this mainframe manufacturer."

That covers some of the concerns of the 4-k RAM manufacturers, who must get the parts designed in, increase output, lower prices, and still make a profit. Production know-how with the silicon gate is a must; the companies that can do the job fast and well will survive in the 4-k RAM business.

Texas Instruments won't release output figures but says it is now No. 1 in production—and, as marketing manager Ed Huber flatly states, "We've read all the estimates" [*Electronics*, Sept. 5, p. 26]. Now that the Texas giant has solved its well-publicized yield problems and is turning out its 300-nanosecond memory chip, it is shipping to distributors as well as original equipment manufacturers and is well positioned as regards availability to both small and large users. The other maker of 4-k RAMs in the Lone Star State, Mostek Corp. of Carrollton, says it is shipping 20,000 parts each month.

At Intel Corp. in Santa Clara, Calif., the word is that 400,000 units

Inside AVX Capacitors.

We're the industry leader in ceramic capacitors. The volume leader in discs and tubes. In multi-layer radial, axial and chip capacitors. The quality leader in capacitors for consumer products. For critical military,

industrial and EDP applications. You know our Ni-Guard® multi-layer chip capacitors with the exclusive silver, nickel, gold terminations. You know our molded Ceralam® radials and axials. Our dipped Skycaps.

Now we'd like you to know our complete line of quality capacitors in all EIA characteristics and Military specifications. Send for the new AVX ceramic capacitor catalog. Get the inside story of the industry leader.

AVX CERAMICS
DIVISION OF AVX CORPORATION



AVX Ceramics
Department C-3
P. O. Box 867
Myrtle Beach, S.C. 29577

Rush me _____ copies of the
new AVX Ceramics capacitor
catalog at no cost to my company.

NAME _____

TITLE _____

COMPANY _____

ADDRESS _____

ZIP _____

TELEPHONE _____

For faster delivery call AVX Ceramics
directly: 803-448-3191.
TWX: 810-661-2252

AVX Distributors: Cramer Electronics, Inc./Jaco Electronics Inc.
Newark Electronics/ Texas Instrument Supply/ Weatherford Co.

Probing the news

will have moved off the 4-k production line by the end of 1974. Most of this, says a company spokesman, will be the slower and cheaper 2107A; the faster B version will grow in volume toward the end of the year and finally replace the A during the first six months of next

year. And in 1975, says Gordon Moore, Intel's executive vice president, the market for units selling for \$10 to \$12 will be around 7 million pieces with Intel aiming to chop off 40% to 50% of that upcoming market for itself.

Motorola Semiconductor feels, not unexpectedly, that it's getting its ducks in a row right on time for the big 4-k push. A company spokes-

man says that its 4-k RAM has been stalled in the start-up mode for a couple of months, but its 3-inch wafer line at Mesa, Ariz., is coming on stream, and the second production module of its new Austin, Texas, plant is due to be for n-channel silicon gate (the first is for [C-MOS]). As a result, Motorola production for 1975 should total 2.5 million to 3 million units. Also, points out the spokesman, Motorola has cut the size of its 4-k chip or die to 23,000 square mils from 32,000, leaving only Intel with a smaller die.

Motorola's 4-k design partner, American Microsystems Inc. of Santa Clara, says it is aiming to produce a high-performance device in the sub-300-ns range. AMI's target is 25% of that market, where price should level at around 25% more than the \$6 to \$8 of the low-speed, low-performance arena, says Frank Rittiman, microprocessor marketing manager. Right now AMI is only producing samples in the hundreds of units, but Rittiman says that fabrication modules in its Pocatello, Idaho, plant should be able to turn out enough by 1975.

Around 450 miles down the California coast from Silicon Valley in Newport Beach, Stephen B. Stuart, manager of product marketing and planning at Western Digital Corp., says that his company will be able to turn out as many 4-k RAMs as customers call for. "The limit is how much we can sell," he says. The big hurdle for most companies is the silicon-gate process, Stuart adds, a process that Western Digital has used to produce some 300,000 pieces a month for calculators. Currently his company can sell parts with access speeds ranging from 250 ns to 450 ns in 50-ns increments, says Stuart, with total output for 1974 coming to "at least 100,000" 4-k RAM parts.

Stuart agrees that the industry will turn out 6 million to 8 million parts in 1975, and prices should get down to \$6 to \$8 during the last quarter. However, says Stuart, "The manufacturer that has the distribution at the low end of the access-time spec, coupled with reliability and the ability to produce the device, will have no trouble selling his product." □

8 CASES FOR SWITCHING TO NATIONAL® SCRs



16-1600 Amperes rms
25-1700 Volts
Power and Inverter SCRs
Patented Regenerative Gate

Call or write for full details



NATIONAL ELECTRONICS

a varian division

geneva, illinois (312) 232-4300

Inside AVX Filters.

The nice thing about an AVX filter is what's inside. A quality, high performance AVX capacitor. Giving all our networks precision performance. Exact conformity to specification.

AVX offers a complete line of broadband, feedthru's and high

frequency filters. In addition, we're introducing a new modular design concept for multi-filters. Using our standard broadband eyelet line, it enables AVX or our customers to build custom filter packages in countless varieties with off the shelf speed. And at off the shelf prices.

Look through our catalog to find the AVX equivalent for filters you are now using. Or the new AVX design that meets your application. You'll find the parts you need. And you'll like the parts you get.

AVX FILTERS
DIVISION OF AVX CORPORATION

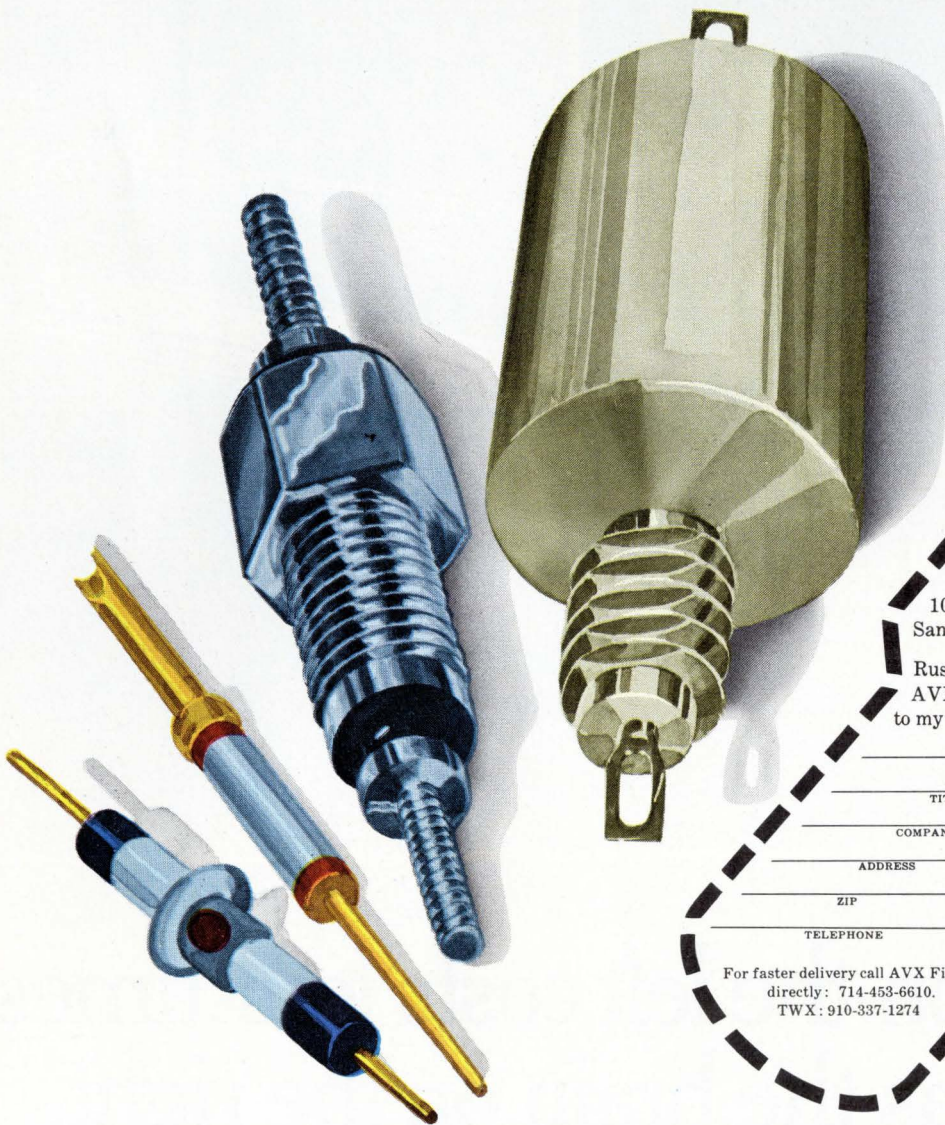

AVX Filters
Department F-3
10441 Roselle Street
San Diego, Ca. 92121



Rush me _____ copies of the new
AVX EMI filter catalog at no cost
to my company.

NAME _____

TITLE _____

COMPANY _____

ADDRESS _____

ZIP _____

TELEPHONE _____

For faster delivery call AVX Filters
directly: 714-453-6610.
TWX: 910-337-1274

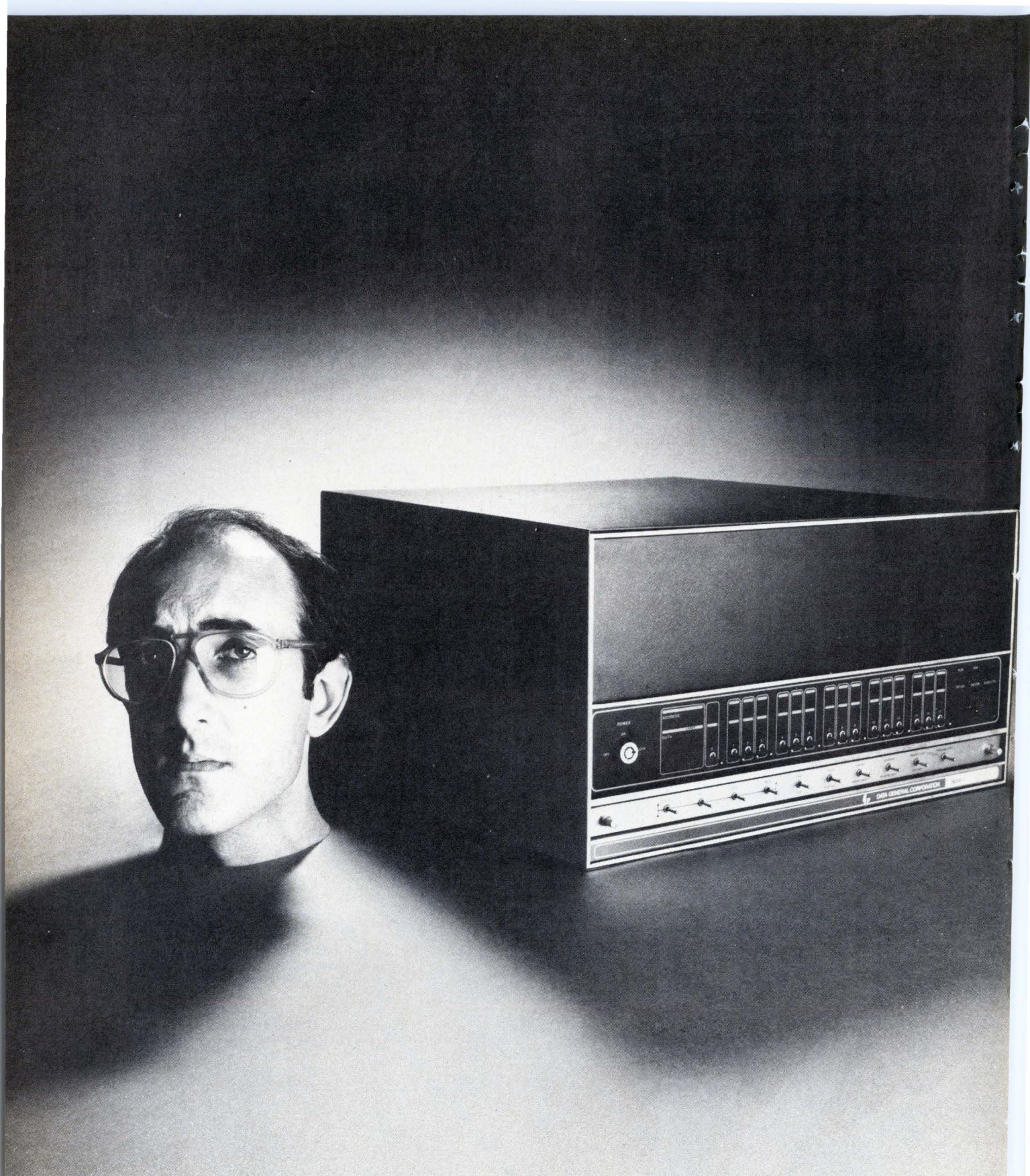

The brain on the left costs four times
as much as the brain on the right.

These days, it's costing a lot more to get a computer programmed than it does to get the computer.

So anyone with any sense of proportion is now checking out systems software as carefully as they used to check out hardware.

Which is an idea we'd like to encourage.

Because we've designed our systems software to help you get your programming done faster, easier and for less money.

Our Real-Time Disc Operating System (RDOS) does a lot of work other operating systems expect programmers to do. To create a file named "FRED," for example, all you have to do is type in "CREATE FRED." You don't have to scout around for the best place for the file, or give it an address, or make sure it won't get disturbed. RDOS does all that for you.

And unlike a lot of other operating systems, you don't have to know RDOS inside out to put it to work for you. The commands are simple, straight-forward, easy-to-remember. To run a program named "BRAIN," just type in "BRAIN" (instead of gibberish like !#AREA, 3 @ 1000, 5 @ 2000! BRAIN @ 1000 @ 2000).

As a matter of fact, RDOS is so easy to use that anyone who's ever worked in FORTRAN should be able to develop programs with it.

Write for our brochure: "Software Isn't So Hard to Understand."

You may discover you don't need a lot of brains to write your software.

DataGeneral

The computer company you can understand.

Data General Corporation, Southboro, Massachusetts 01772. (617) 485-9100.
Data General of Canada, Hull, Quebec, J8Y3S6. Data General Europe, 116 Rue de la Tour, Paris 75016 France.
Data General Australia, Melbourne (03) 82-1361/Sydney (02) 908-1366.

Circle 83 on reader service card

**OUR POWER
SEMICONDUCTORS
ARE SO GOOD
WE USE THEM OURSELVES.**

20,000 TIMES A DAY.



That's the rate at which Delco Electronics supplies a variety of products for GM cars.

Under one roof we design and manufacture complete systems, including the power semiconductors that help make those systems work. This can mean a lot to you. Here's why:

We know the requirements and standards that must be met to produce over 20,000 systems a day. We know what it means to deliver on time, to meet our own production schedules. And we know the importance of component quality in assuring reliability of the end product.

Our semiconductor devices are used

in the Delco AM radios, AM/FM radios and stereo tape systems we produce for GM cars. They are also used in the GM High Energy Ignition systems, I.C. voltage regulators, alternators, and in the new combination front seat/shoulder belt interlock systems you find in all the 1975 GM cars.

And all the capabilities that go into Delco semiconductors can work for you, too.

There are select distributors with stock on hand strategically located coast to coast. For the distributor nearest you, phone

your closest Delco Electronic regional sales office: Kokomo, Ind. (317) 459-2175, Van Nuys, Calif. (213) 988-7550, Union, N.J. (201) 687-3770.

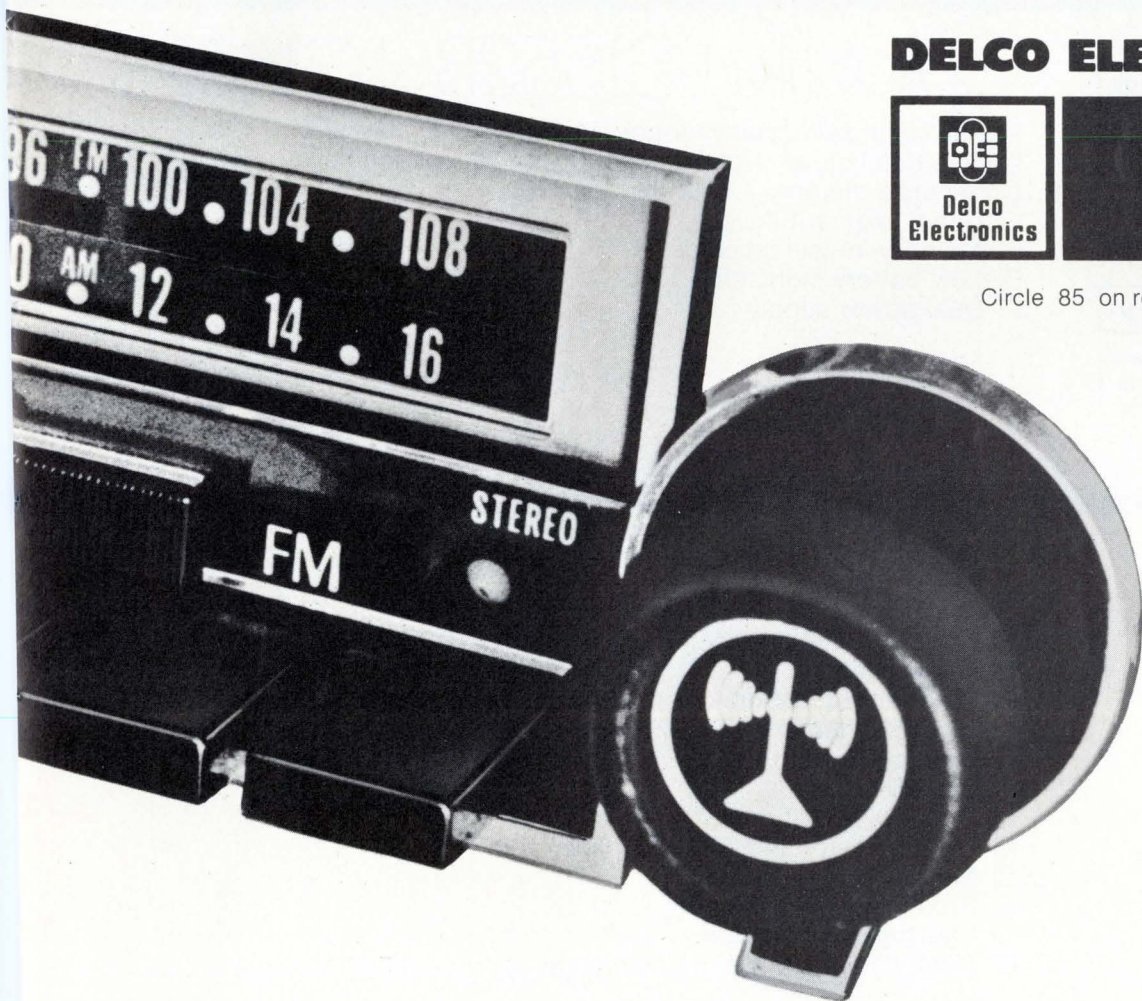
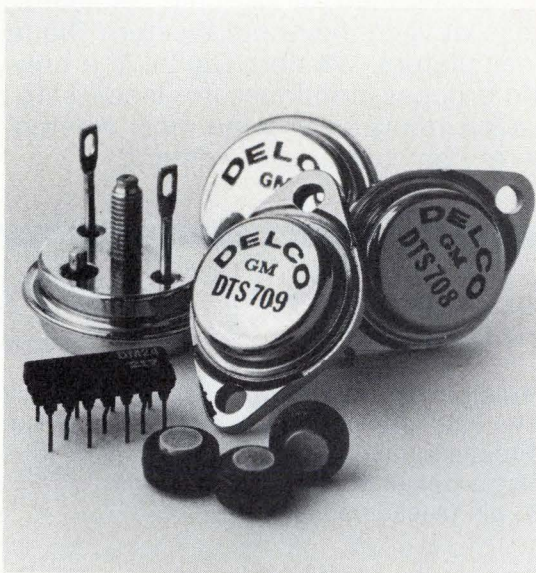

DELCO ELECTRONICS



Circle 85 on reader service card

We Got the Whole

The mastery of MOS/LSI silicon gate technology has enabled Western Digital to design and produce a line of highly sophisticated, single-chip calculator devices. The performance, price and reliability of these devices have put Western Digital in a significant position of leadership in electronic calculators. Western Digital, the only manufacturer of calculator chips using the silicon gate process, continues this leadership by offering an even broader line of calculator chips — each incorporating the most wanted features, as well as unique ones to meet each and every calculator requirement.

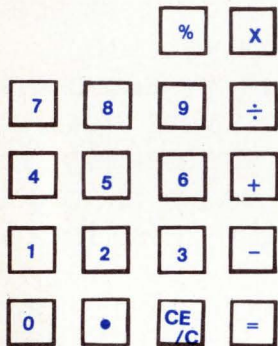

ChepStik CS1752F

- Full eight digit display for positive or negative numbers
- Five function with repeat capability on \square key
- Direct segment drive
- Single power supply / 6v-9v range
- 28 pin plastic package

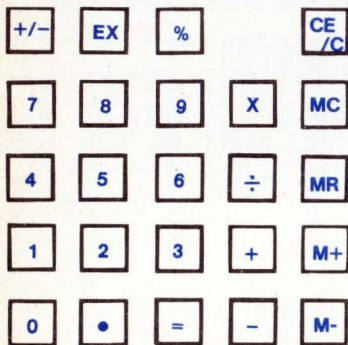

ChipStik LC1552B LC1662B

- Full eight digit display for positive or negative numbers
- Five function with repeat capability on all function keys
- Versatile memory / M+, M-, MR, MC
- Direct segment drive
- Memory-in-use indicator
- Low battery indicator
- Dual power supply

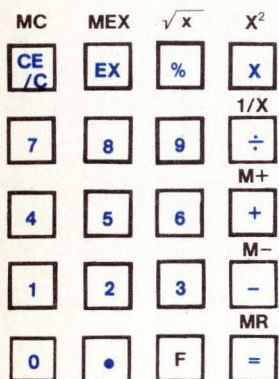

FlipStik FS1732B

- Full eight digit display for positive or negative numbers
- Eight function / +, -, x, ÷, %, \sqrt{x} , 1/x, x^2
- Automatic constant with repeat capability on \square key
- Versatile memory / M+, M-, MR, MC, MEX
- Flip key — flips to "upper case" using only 20 keys for total functional capability
- Direct constant-current segment drive
- Display restoration with clear key
- Memory-in-use indicator
- Flip key in use indicator
- Low battery indicator
- Single power supply / 6v-9v range

watch for SlipStik / make slide rules obsolete

"Shtik" in Calculators

"Stik" Family Features

- Full floating point entry & results
- Algebraic (sequential) entry
- Automatic constant with repeat add/subtract/multiply/divide
- Chain calculations
- Overflow protection/symbolization/decimal point wrap-around
- Simplified add-on/discount

- Floating minus sign/credit balance
- Display blanking/power saver feature
- Universal display interface
- Double action clear key
- Leading zero suppression
- Internal power-on clear
- Internal clock generator
- Internal keyboard encoding/debounce
- Low chip power consumption

KwikStik LC1692B

- Full 10 digit display for positive or negative numbers
- Eight function / +, -, x, ÷, %, \sqrt{x} , $1/x$, x^2
- Automatic constant with repeat capability on \square key
- Versatile memory / M+, M-, MR, MC
- Automatic summation to memory / Σ switch
- Direct segment drive
- Display restoration with clear key
- Memory-in-use indicator
- Low battery indicator
- Dual power supply

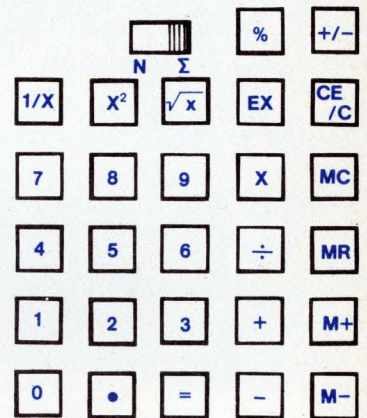

ChopStik MC1532B

- Selectable 10 or 12 digit display for positive or negative numbers
- User selectable arithmetic or algebraic entry
- Versatile memory / M, M+, M-, = M+, = M-, MR, MT, MC
- Automatic summation to memory / Σ switch
- Memory-in-use indicator
- Various fixed point rounding options / round-up, round-off (5/4), round-down
- Fixed point, floating point, or dollar mode / keyboard or slide switch select
- Display restoration with clear key
- Low battery indicator
- Dual power supply

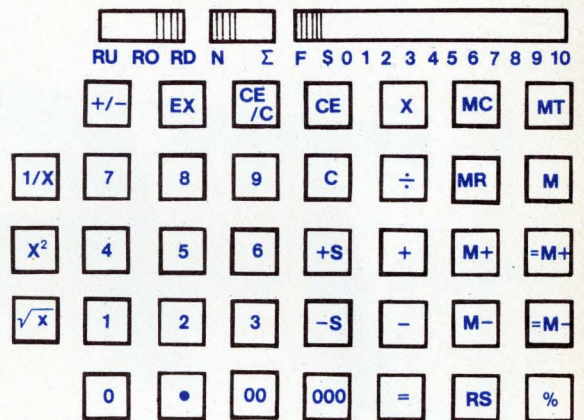

Note: Capability for Arithmetic (Business Logic) and Algebraic entry are provided. These functions are usually not combined in a single machine.

PrinStik PS1762B

- 10 or 12 digit entry and results
- Custom printer interface
- Microprogram flexibility / customized functional operation
- Business logic
- Floating point, fixed point, dollar mode / keyboard or slide switch select
- Fixed point rounding options
- Automatic constant
- Internal power on clear
- Single power supply

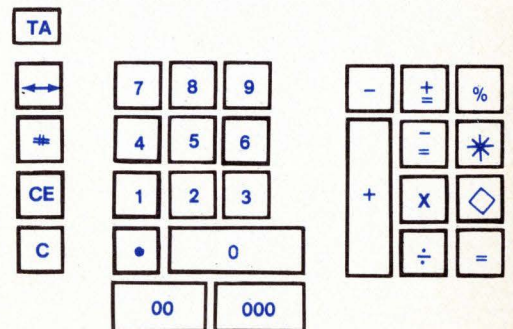



WESTERN DIGITAL

C O R P O R A T I O N

3128 RED HILL AVENUE P.O. BOX 2180
NEWPORT BEACH, CALIFORNIA 92663
TELEPHONE: 714-557-3550
TWX: 910-595-1139

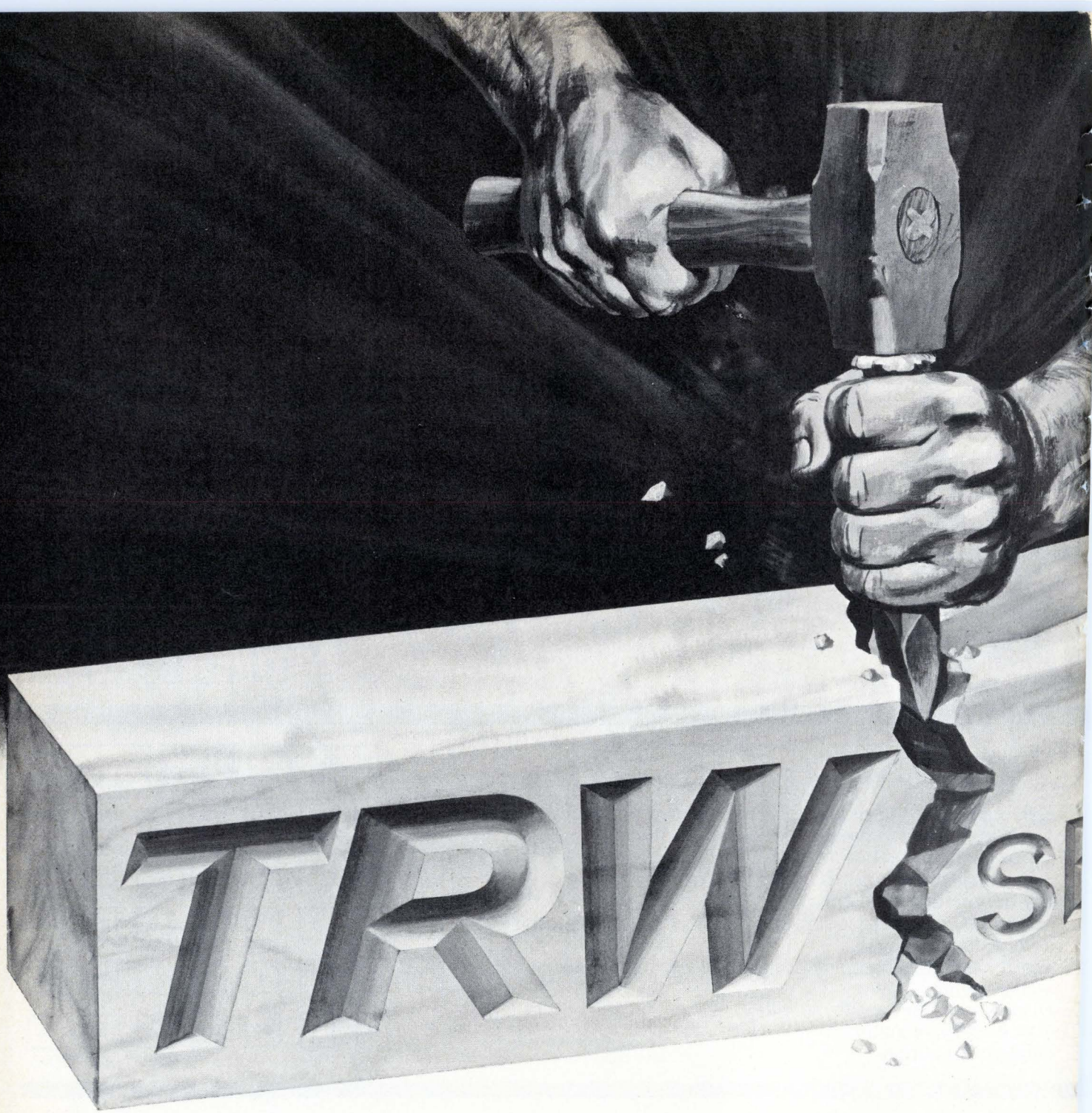
Circle 87 on reader service card





SEMICONDUCTORS

We've fractured our name

(and reorganized our thinking to make it more like yours)

Because you know us for our expertise in either RF/microwave transistors or power supply semiconductors, the name TRW Semiconductors was too broad to be useful. It implied we were generalists, and we aren't. So we've re-evaluated and split into two new

units under two new names that define our real business.

We have always had separate research, separate technology, separate manufacturing and—to a surprising extent—separate customers for each line. And a breadth of products and capabilities in each specialty.

So now we are two. TRW RF Semiconductors and TRW Power Semiconductors.

It makes sense. Because that's the way you think of us, and that's the way we are. You'll be hearing a lot more from us soon. Separately, but equally.

TRW RF SEMICONDUCTORS

TRW POWER SEMICONDUCTORS

AN ELECTRONIC COMPONENTS DIVISION OF TRW INC., 14520 AVIATION BOULEVARD, LAWDALE, CALIFORNIA 90260
Circle 89 on reader service card

A low-cost scope offer more than a low

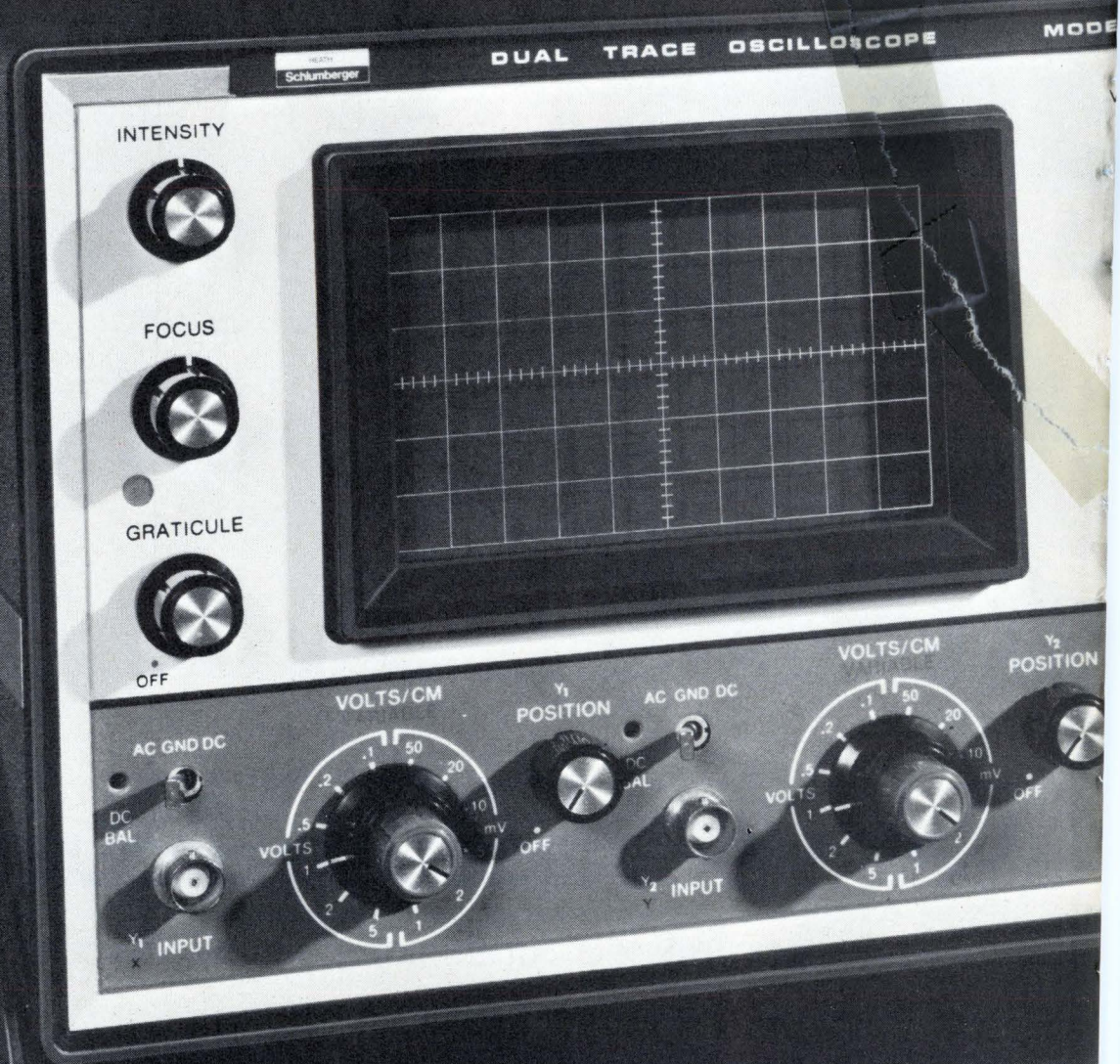

should price.

The new Heath/Schlumberger dual-trace SO-4510 has DC-15 MHz bandwidth, 1 mV sensitivity, post-deflection accelerated CRT, vertical amplifier delay lines & more ...for only \$750*.

The actual value of any oscilloscope is really how much it benefits the user in price, or performance, or both. Our SO-4510 offers a low price plus DC-15 MHz bandwidth, vertical sensitivity of 1 mV/cm, time base sweep to 100 nsec/cm and complete dual-trace capability. And it also offers many features that other manufacturers don't provide at anywhere near our low price.

Like post-deflection acceleration for a brighter trace and faster writing speeds. Many input signals that wouldn't be visible on a mono-accelerated CRT are presented in a sharp, bright trace on the SO-4510. Think of your applications for an oscilloscope. Can you really do without our additional brightness?

Trigger bandwidth—is it specified? The SO-4510 will typically trigger on signals up to 45 MHz and is guaranteed to 30 MHz. And there's no stability control needed with the digitally-controlled triggering circuits. In the automatic mode, a reference baseline is generated even when the trigger signal is absent. Complete triggering controls are provided with choice of AC or DC coupling, triggering at any point on the vertical signal. An AC fast coupling mode is provided to reject low-frequency components of the trigger waveform for accurate scope triggering. Choice of automatic or normal sweep uses any one of 22 time bases from 0.2 sec/cm to 0.1 μ sec/cm.

Vertical input sensitivity of 1 millivolt—over the full bandwidth. Think of this in terms of the way you're most likely to use an oscilloscope—with a X10 probe. With SO-4510 and a X10 probe, you can still read waveforms to 10 mV/cm, not the 50 or 100 mV/cm found on other scopes. We also offer a companion high impedance isolating probe with 10:1 attenuation for only \$23.95*.

Internal delay lines for the vertical amplifier insure start of the horizontal sweep prior to the beginning of the vertical signal. They allow display of at least 20 nanoseconds of the pretriggered waveform, insuring that the complete waveform will be displayed. Can you really do without this pulse analysis capability?

True X-Y capability. X-Y operation uses Channel 1 for horizontal deflection and Channel 2 for vertical deflection. Phase measurements can be made using the standard vertical inputs, not the horizontal input as other scopes require.

Dependable, rugged design with easy-to-service construction. The SO-4510 was designed by service-oriented engineers who have been designing low cost scopes for a long time. The SO-4510 is remarkable easy to service. All major circuitry is located on five circuit boards for easy trouble-shooting. Push-on connectors permit fast removal of any board. Even the CRT can be removed and replaced in a matter of minutes.

Most important, the SO-4510 is designed and built by Heath—specialists in high performance, low cost instrumentation. We know how to provide good instrument value for the money, not merely another low-price instrument. And we're not just entering the low-cost instrument market, we've been here for years. The SO-4510 was designed for a maximum of performance at the lowest possible cost. Compare our scope with the competition. You won't find a better value than the SO-4510 from Heath/Schlumberger.

The latest Heath/Schlumberger catalog describes a complete line of high performance, low cost instrumentation for industrial, R & D and educational applications. Mail the reply card or the coupon below for your free copy.



Heath/Schlumberger Instruments
Dept. 531-289
Benton Harbor, Michigan 49022

HEATH

Schlumberger

Please send the latest Heath/Schlumberger catalog.

Name _____
Title _____
Company/Institution _____
Street _____
City _____
State _____ Zip _____

*Mail order prices; F.O.B. factory. Prices & specifications subject to change without notice.

EK-432

Remember the time you wanted something special in 3½ digits?

Your time has come.

When we at Analog Devices introduced the 5-volt digital panel meter, we said there'd be more—a lot more. Look what we can offer you in 3½ digits alone.

Why so many? To give you a choice. So you won't have to order or build specials anymore. Because now we've made what you need a standard.

Let's say you need 3½ digit resolution. You can get it displayed in Numitron, LED, or even Sperry.

In Numitron, we can even give you a choice of green or red.

Now you have to power it. Most of our meters are 5 volts DC

because so much of what you're working on is in TTL logic. But if you need one that can run on 115 volts AC, you've got it. The AD2006 with Sperrys—in AC or DC. It's our latest DPM. But not our last.

You may even be designing something that will end up in another country. We can help you there too. With meters that will operate on voltages in Europe, the U.K., Japan, and just about anywhere else.

If you look closely, you'll see that one meter isn't a meter at all. It's a remote display. Sometimes you need that kind of thing.

But then giving you what you need is what it is all about. Like reliability. And extra features like card edge connectors. Ratiometric inputs. .05% accuracy. And low prices. Ours start at \$49 in hundreds for the remote display.

Now, would you like to see what we can do for you in 4½ digits—or 2½ digits? Give us a call. We'll see that you get a copy of the "Designer's Guide to Digital Panel Meters." And any other help you may need.

Analog Devices, Inc., Norwood, Mass. 02062. On the East Coast, call (617) 329-4700. In the Midwest, (312) 297-8710. And on the West Coast, (213) 595-1783.



 **ANALOG
DEVICES**

Then it was special. Now it's a standard.

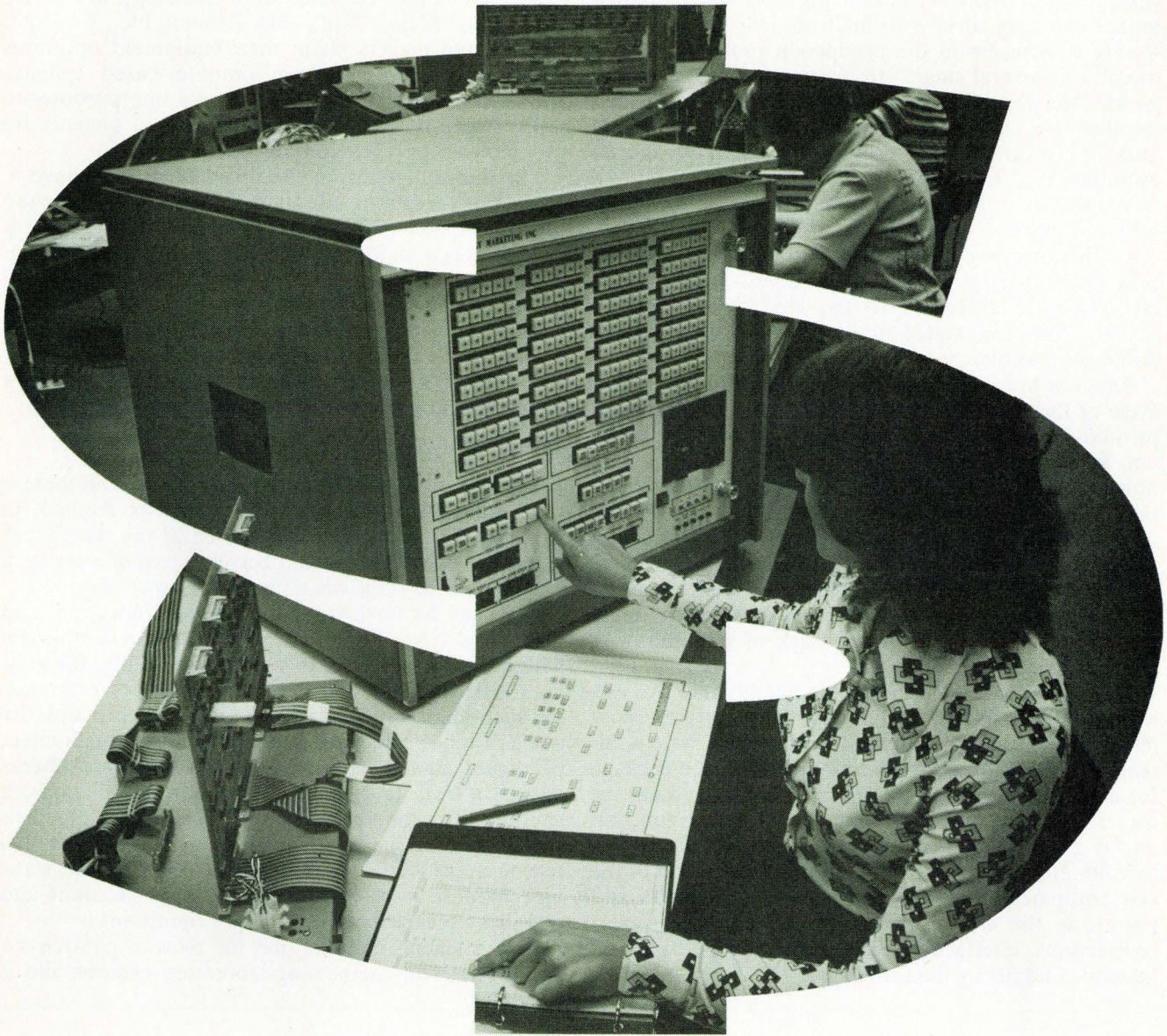

Automated testing pays off for electronic system makers

Testers are becoming necessary to spot and diagnose defects in components of constantly increasing complexity; the manufacturer of end products may find testing will mean the difference between profit and loss

by Stephen E. Grossman, *Instrumentation Editor*

□ Once affordable only for complex and costly military systems, automated testing has become a cost-cutting—and profit preserving—must for makers of a variety of electronic equipment. With the relentless growth in complexity of today's electronic products, no equipment maker can long survive without the help of automatic testing somewhere in the production process, and frequently in several stages—from straightforward go/no-go tests to uncover incoming duds to dynamic simulated performance exercises of complete systems. The variety and sophistication of the tests required virtually dictate automation of the testing process.

What's more, it has become more and more important to diagnose why a part is defective. That knowledge—because it points the way to saving, not scrapping, a costly subsystem or circuit board—makes a dollars-and-cents difference to the electronic-equipment maker. And automated testing makes cost-effective diagnosis feasible.

The new breed of testers finds jobs all through the life cycle of the product—incoming components, assembled printed-circuit boards, subassemblies, deliverable product, and after-delivery troubleshooting. Portable testers now extend diagnostic power right into the field to expedite repairs. And new in-circuit testing gear checks components mounted on pc boards as if they were still unmounted. These automated testers go a long way toward reducing the labor-intensive manual testing of parts and subassemblies. Of even more value, the more sophisticated testers also keep track of how many of what kinds of faults are found.

Automated test equipment falls roughly into two categories—the dedicated tester and the general-purpose tester. The dedicated tester, an off-the-shelf system, often includes a software testing and diagnostic package for a specific task. For the general-purpose system, the user selects the sources of stimuli, such as the function and rf generators, as well as such measurement devices as voltmeters and spectrum analyzers. The maker of the test equipment then assembles these subsystems and provides the necessary program control, interconnections, interfaces for the units, and perhaps will generate and debug the software.

There is a growing trend to build test systems around dedicated controllers, rather than minicomputers, which have been most frequently used in the past. Among the companies pursuing this approach are Macrodata Corp., Woodland Hills, Calif., Technology Marketing Inc., Costa Mesa, Calif., and Zehntel Inc., Concord, Calif. These makers claim their equipment optimizes testing because, unlike minicomputer-based systems, their controllers are designed for only one purpose—to test. What's more, many of the dedicated systems are programmed simply by read-only memories.

The minicomputer, on the other hand, may have to waste time executing programs through software, and memory space may be wasted. Where software is needed, it is a major cost in testing, as shown in Fig. 1. The costs are broken down for both analog and digital printed-circuit-board testing as a percentage of total costs over a seven-year span. What is evident and perhaps surprising is that the equipment amounts to a relatively minor percentage. The major amount of money will be spent on software and in troubleshooting.

Weighing dynamic and static tests

Digital testing may be dynamic or static, and there is some controversy over which is the better method. In dynamic testing, the device is driven at the same clock rate it will encounter when it becomes part of a product. Tests are called static when made at a slower speed.

Tests can be further subdivided into functional and parametric types. Functional testing checks compliance with a logic truth table. In parametric testing, the voltages, currents, and shapes of the pulses are examined for such characteristics as propagation delay and rise and fall times, which amounts to analog measurement of digital signals. Static functional tests are checks against a truth table at relatively slow speed. Logic is checked after the various gates have settled into their steady-state levels. Proponents of dynamic functional testing argue that it is more authentic than the static type because it takes circuit delays into account and provides a means for detecting race conditions.

But opponents contend that the more expensive dynamic test is an engineering-laboratory exercise and is

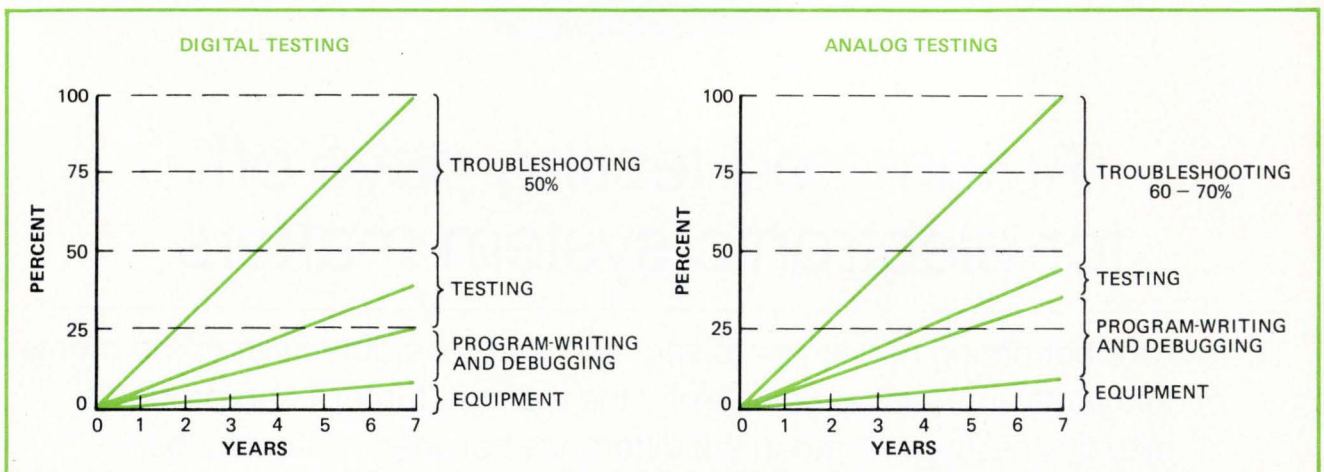

1. **Where the dollars go.** Plots denote the relative costs of automated testing. Note that hardware amounts to less than 15% of the cost over a seven-year span. Time spent troubleshooting and writing and debugging the test program are the principal costs.

unnecessary. They claim that fewer than 1% more defects can be detected by testing at full speed than by running only at low speeds.

Regardless of which route to testing he chooses, the equipment manufacturer stands to benefit from testing if his production volume is high enough. What's more, the earlier the faults are discovered, the less expensive they turn out to be. An excellent example is cited by G.W. Ince., vice president of support and planning at Sycor Co., Ann Arbor, Mich., a manufacturer of terminals, who says the test system used by his company catches failures at an early stage. "This saves both time and dollars because failures at the final-assembly level cost 30 minutes per failure, while failure at the board level costs 9.5 minutes per failure. And it is this savings in time that has enabled us to ship an additional 14 terminals per week."

But before the manufacturer makes his choices among system approaches and testing modes, he must determine if testing is economically feasible for his operation. And that's a complex process. Costs must be calculated on a case-by-case basis. For components, formulas are presented in "Testing vs not testing: the costs," p. 108. Whether or not automated testers are worth the investment depends on the volume of parts used, the acceptable quality level of incoming components, and the impact on both manufacturing costs and product reliability of not testing any given component.

The testing dilemma

The component buyer is confronted by a difficult and costly problem: many a component delivered to his receiving line is out of specification or dead on arrival. If



2. How many duds? Sample testing to a 0.65% acceptable quality level means that 95% of lots with 0.65% defective devices will be accepted. However, the tail of the curve indicates that 50% of the lots with 2.09% defectives will be accepted, and 10% of lots with 4.8% defectives will be accepted. Each defective device that slips past incoming inspection leads to expensive troubleshooting and rework.

not, it may fail later and cause the end product to fail. Although at later stages in the cycle, it is usually desirable to test every subsystem, usually only a designated portion of incoming devices is sampled.

Quality-control specialists use the term acceptable quality level (AQL) to describe the percentage of bad parts in a lot. Although defined in all its complex detail in MIL STD-105, it simply boils down to a specified probability (usually 95%) that a lot will be accepted. To obtain this figure, only a specified percentage of the lots is tested.

It turns out that a 0.65% AQL means that a lot with

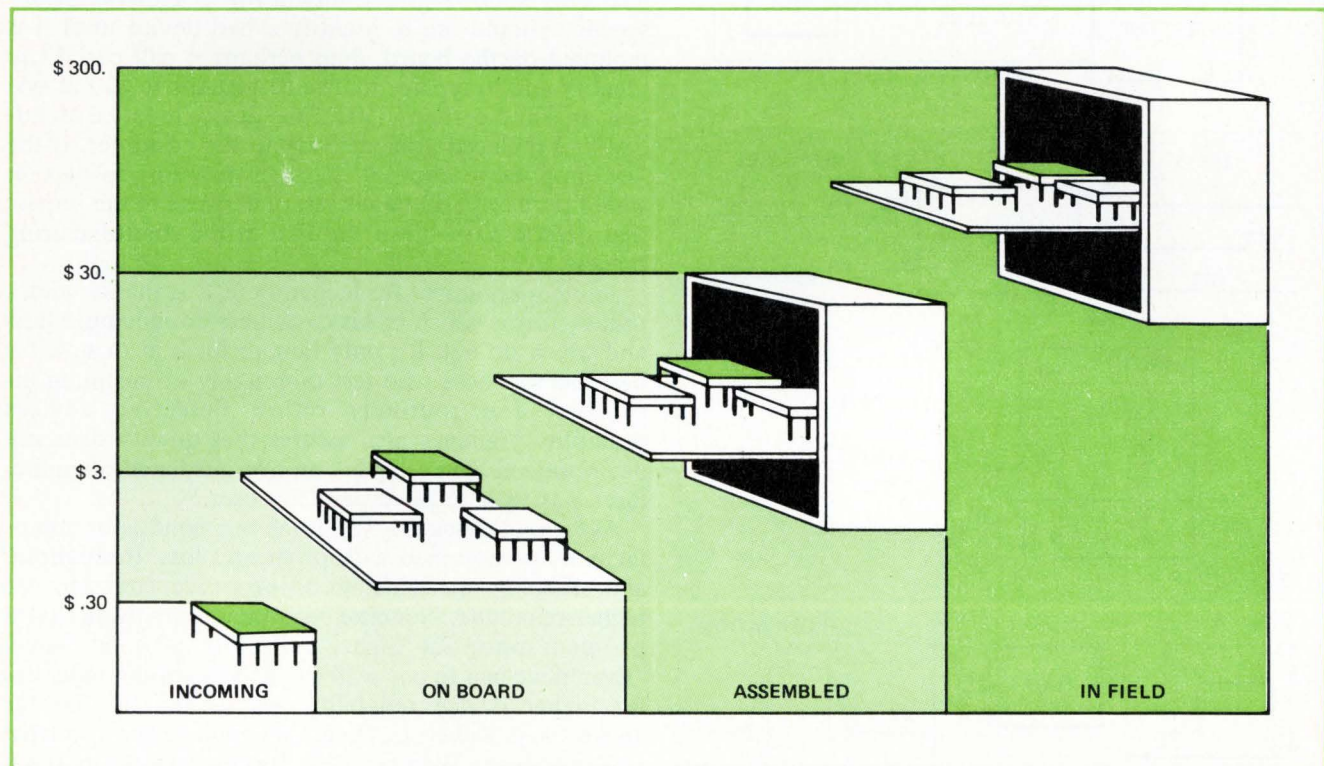

3. Test it later? A defective IC that slips past one manufacturing step may cost 10 times more to catch at the next stage. Such escalations can often justify the expense of automated testing at each stage of the manufacturing process.

Translating testers' terminology

Automated test equipment operates in several modes and it is useful to know the meaning of the more common terms.

Digital testing may be either dynamic or static. When a digital test set is driving the unit under test at the same speed it will operate in the finished product, testing is said to be dynamic, as shown in (a). If the unit under test is driven more slowly, then the test is termed static.

Dynamic and static tests may be either functional (b) or parametric (c). Functional testing of digital circuits means checking for the correct output response to a sequence of test-pattern inputs. These tests may be performed at either dynamic or static speeds. Parametric tests, which measure such device properties as rise time (t_r) fall time (t_f), and propagation delay, must be performed at dynamic speeds to be meaningful.

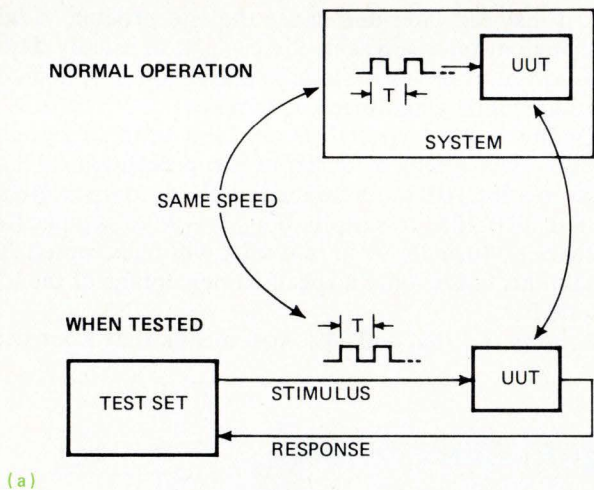

(a)

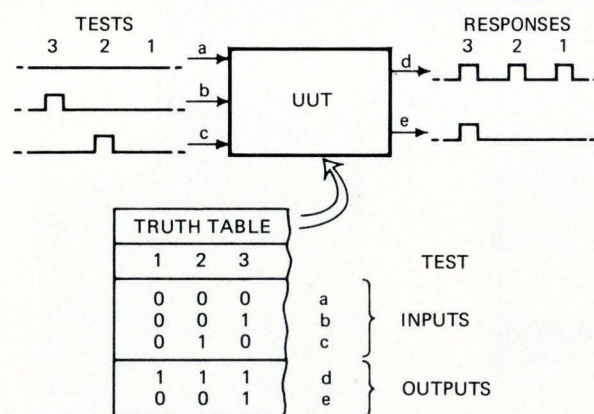

(b)

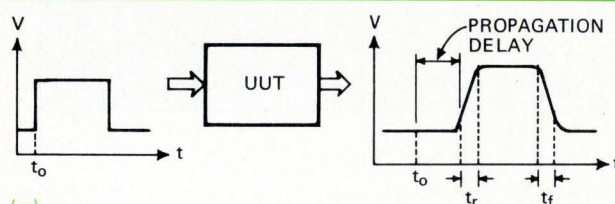

(c)

0.65% defective parts will have 95% chance of being accepted. However, as shown in Fig. 2, it also leads to a lot with 2.09% defectives being accepted 50% of the time, and lots with 4.8% defectives, 10% of the time. The defective devices that slip through will be costly to identify and replace later on.

"Though 0.65% AQL may be great for nuts and bolts, it can be disastrous when you are talking about acceptance levels for semiconductor devices," says Gerald Kutcher, an advisory quality engineer at Inforex Inc., Burlington, Mass. "The need for testing depends heavily on how many devices populate a board. Take the case of building transistor radios where the transistors meet a 1% AQL—you put 10 transistors in each set. Then, at least nine out of 10 will be expected to work," says Kutcher.

"Now, examine what happens if you buy ICs at 1% AQL. Assume three cases: say that you put 10 on a board. Then only one out of 10 boards is no good. But if you put 50 on a board, then the likelihood jumps to 50% that the board will malfunction. Should you put all 100 on a single board, then there is virtually no possibility that any board is good," he concludes.

Clearly, large board populations lead to expensive troubleshooting and rework costs, so the earlier each defective device is identified and weeded out from the manufacturing process, the better. Moreover, attaching some costs shows how expensive it is to wait.

The cost of not testing

It costs about a penny to test each IC at incoming inspection. If a user must test 100 to find three bad ones, then each bad device costs 30 cents to identify and reject. This is shown graphically in Fig. 3. However, if inspection should fail to identify a bad device until it is mounted on the board, then perhaps it will cost \$3 to identify and to replace it. The cost jumps to \$30 at system level and perhaps \$300 if the device must be identified and replaced after delivery to the customer. If the AQL dropped to about 0.1%, then incoming inspection would probably still be necessary because of the impact that defects have down the line in the manufacturing process.

Another argument for incoming tests is that a vendor usually learns which of his customers do incoming tests and which do not. It's only human for him to save his best lots for those who test thoroughly at incoming inspection and routinely return defective devices promptly. Vigilance also assures that quality does not deteriorate in the event that an overburdened manufacturer may rush untested parts to a user.

As for improving the AQL level, semiconductor manufacturers preoccupied with profit and loss, throughput, and shipping are reluctant to negotiate contracts for higher reliability. Nonetheless, many users think that a premium price for higher reliability is good value. "Even if we had to pay a 20% to 25% premium to assure far higher device reliability, we would still be far ahead," says Robert C. Foster, an engineering specialist at Xerox Corp., Webster, N.Y. But Foster says there's a growing need for 100% testing as purchased components grow more complex. "With the growing use of

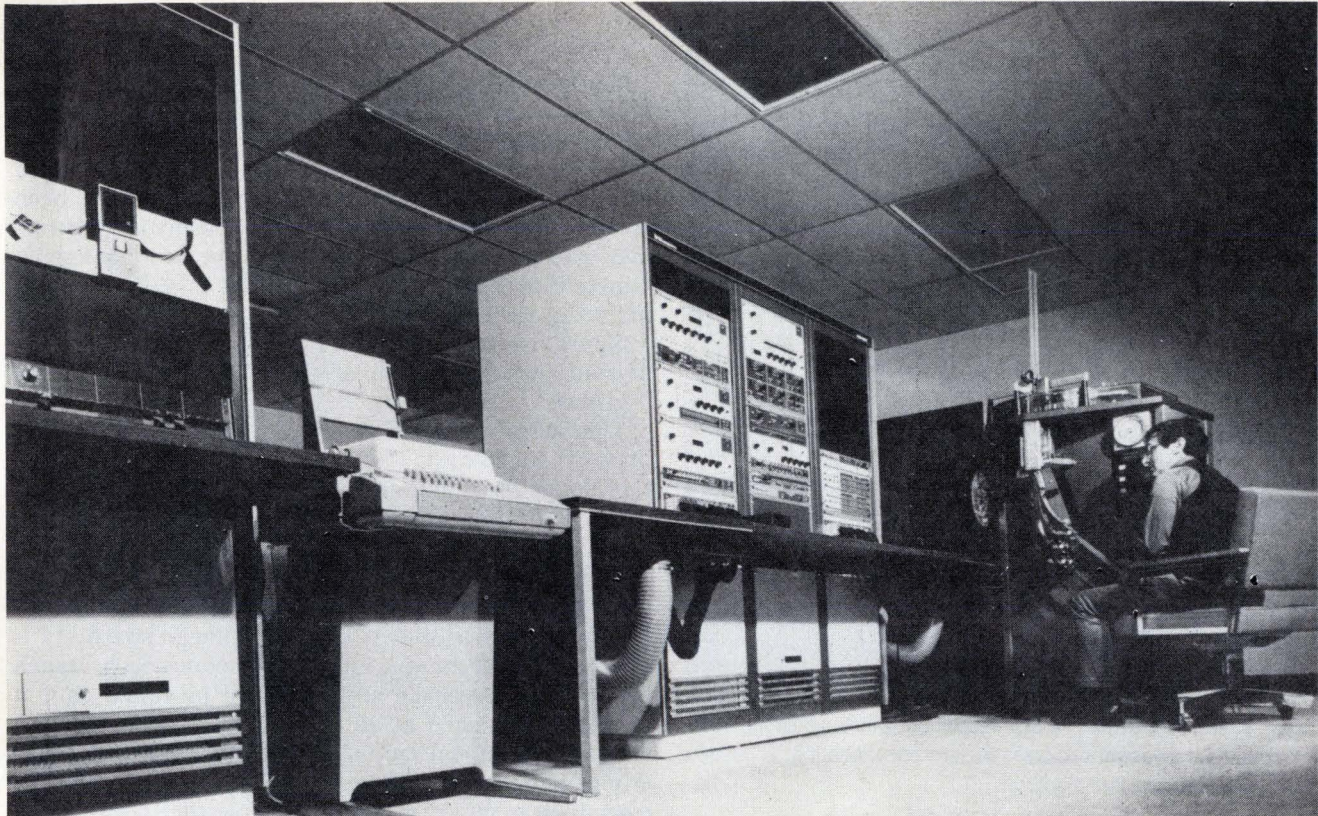

4. Diagnostic dreadnaught. Macrodata's MD-500 diagnostic-test system is designed to perform digital functional and parametric testing of bipolar and MOS LSI devices at data rates as high as 10 MHz. Parametric and functional testing may be performed simultaneously. Its compiler-based operating system can perform a number of tasks simultaneously, such as operating two test stations in parallel and compiling.

memories and microprocessor chips, I don't see that we will have any alternative but to test them at incoming," he says.

A number of companies have designed testers to test LSI, including memories and microprocessors. And there is a growing tendency to test LSI devices in parallel in an attempt to cope with high volume and relatively long test times. This means that if one test fixture goes down, the system has to interrupt testing.

System is asynchronous

Macrodata claims that its MD-104M system, which ties test heads into a system in such a way that they operate independently and asynchronously, is more efficient than a parallel system because if the main computer goes down, the test fixtures continue testing. Also, different devices requiring different test patterns can be tested simultaneously.

Moreover, Macrodata says that the MD-104 system's six test heads, at an additional cost of only 15% per station, can deliver 50% more throughput than can six heads based in parallel to one test-pattern generator. Macrodata also makes a model MD-500 (Fig. 4), which can perform functional and parametric tests on bipolar and MOS devices. It can perform five different tasks simultaneously.

One popular IC tester is the J283 circuit-test system, known as the "slot machine." Made by Teradyne Inc., Boston, it performs both static functional and parametric tests on digital and hybrid devices and has an

add-on option for dynamic testing. Pulse capabilities are available for measuring propagation delay and transition time. The J283 provides functional tests at 100 kilohertz, and an optional high-speed capability at 20 megahertz is available for the testing of memories.

One or more satellites can be connected to the system mainframe, and each satellite can operate as many as four test stations. The smallest J283 configuration has the capability to test devices with 12 input/output terminals, plus V_{CC} and ground. The system can be expanded in increments of six channels to test devices with 144 or more I/O terminals.

The J283 delivers data of several different types, such as lot-summary sheets that indicate the number of devices tested at each station, how many devices are classified into each category, and the number of times each test in the program has failed. The system will also log parameter values of each device and tell whether or not the results satisfy the programed limit value.

Tektronix Inc., Beaverton, Ore., says its model S-3260 serves design, as well as incoming, test functions on increasingly complex devices—memories, microprocessors, and the like. Says Jim Fisher, market-development manager, "Since modern LSIs are indeed systems, design engineers must test them thoroughly so they can characterize device performance and design companion circuits accordingly.

"At incoming inspection, with LSI memories and microprocessors, you're really into the same testing game as the guy testing a core-memory computer. You must



5. Component tester. Teradyne's K167B relay-test system is designed to examine a relay in any sequence with a single insertion. The system provides various types of hard-copy data that is valuable to the relay user and manufacturer.

prove its ability to store, retrieve, and manipulate data. The only change is, today, the CPU is on a single chip, and so are the memory blocks. So now you do system-level testing on the individual chip."

High-speed test equipment such as the Tektronix S-3260 with its 20-MHz capability is claimed to be particularly valuable because the latest IC devices often have multiple pin functions. The reason is that the IC package has only a limited number of pins—40 leads is typical. This may be insufficient to provide all the interface necessary. Thus, the chip designer adds I/O-switching to enable pins that provide input functions at one moment to be switched nanoseconds later and become output pins.

But ICs are not the only components tested at incoming inspection. There are a number of dedicated testers on the market for testing such passive devices as capacitors, as well as discrete devices such as diodes. Both General Radio Co., Concord, Mass., and Teradyne, among others, make dedicated component testers. A Teradyne K167 B relay tester is shown in Fig. 5.

Testing should not stop at the incoming level because mounting the components into circuit boards or other assemblies provides new opportunities for defects to develop. Nor can incoming inspection deliver a 100% confidence level. Defective components that escaped detection at incoming inspection must be identified and replaced before the project is shipped.

In-circuit component testing

In-circuit component testing is a new and powerful technique that is coming on strong. The equipment individually tests components mounted on a printed-circuit board as if they were still unmounted. This over-

comes the so-called lack of visibility when trying to identify a defective component among many mounted on the board. Visibility is a term describing the capability to sense and thereby localize malfunctions to a particular component.

In-circuit testing can check either unloaded or loaded pc boards immediately after the components have been soldered into place. The technique is particularly attractive when a large number of passive components is mounted on a board. It is sometimes called a "bed-of-nails" approach because the circuit board is mounted in a fixture that has pins placed so they will contact each node on the soldered side of a circuit board, as shown in Fig. 6(a).

The board is held in place by a vacuum system that draws about 55 cubic feet per minute of air from the fixture. (Note the manifold on the right of the fixture.) In-circuit testers provide visibility not attainable if only an edge-connector type is employed. It is thus able to test capacitors, resistors, and board continuity. It is also effective at identifying reversed diodes and polarized capacitors, as well as solder bridges, on the pc board.

A guarding technique effectively isolates each branch component electrically so that it can be tested as if it were not connected at all in a circuit. The equipment uses an operational amplifier, well known for its property of having its input at a virtually zero potential. A test circuit is shown in Fig. 6(b). Note that point X is a virtual ground, and points Z are actually grounded. Thus, components between point X and ground have zero potential across them and no current flowing through them. As a result, these components have no effect on the operational amplifier.

In addition, components between point Y and ground are driven by the output of the operational amplifier, and they have no effect on the operational amplifier's feedback loop. Thus, other components play no role in the measurement, and the value of the resistor R_F can be determined from the usual equation for an operational amplifier shown in the figure. Test time per component averages about 6 milliseconds.

The Faultfinders' model FF101 (Fig. 7) made by Faultfinders Inc., Latham, N.Y., is an in-circuit tester programmed by a paper tape that can load its contents into a core memory in about 15 seconds. General Data-Comm Industries Inc., Wilton, Conn., uses an FF101 to cut manufacturing costs on its line of modems and multiplexers. John Bouse, quality-control manager at GDC, says: "It used to be that 60% of the complex boards going to final test would function. Thus, the 40% that were defective would require a half to three quarters of an hour each to debug. The Faultfinder tester has raised the number passing final test to about 90%."

Bouse says that the cost of the fixture and a debugged test program for each new board runs about \$2,000. With runs as low as 100 boards a week, he estimates, the payback on these one-time costs is about 10 weeks. The testers themselves cost between \$40,000 and \$65,000, depending on the various options selected.

Systomation Inc., Elnora, N.Y., also make branch-testing machines. President Stan Anderson points out that there are now some 200 of the company's Fixit ma-

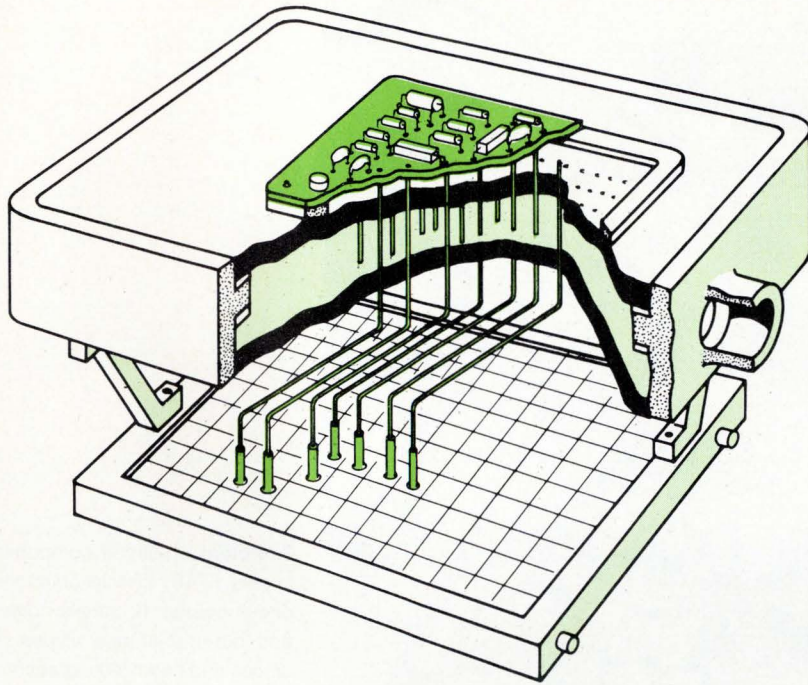

(a)

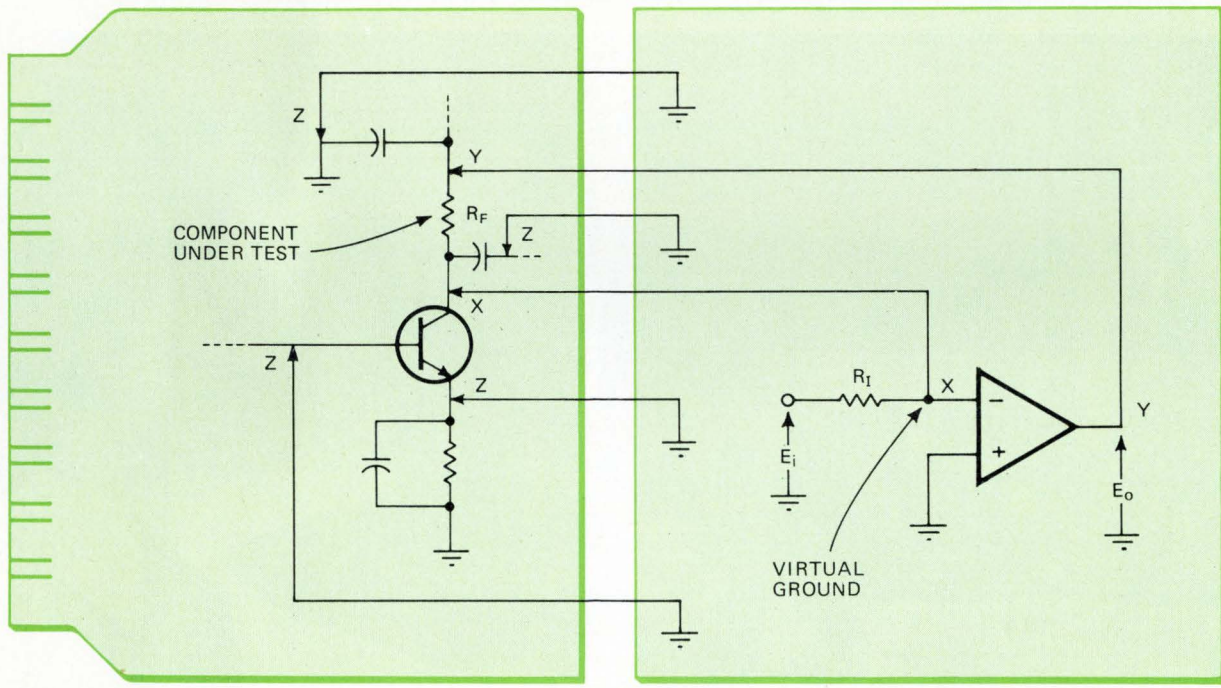

PRINTED-CIRCUIT BOARD

IN-CIRCUIT COMPONENT TESTER

(b)

$$E_o = - (R_F / R_I) E_i$$

6. Bed of nails. Spring-loaded pins contact the solder nodes on the bottom of the printed-circuit board to enable an in-circuit tester to test the components individually as if unmounted (a). In-circuit tester uses a guard circuit to ensure that each component is isolated from the others on the circuit board (b). Note that the virtual ground at node X and actual grounds at Z electrically isolate component under test R_F .



7. Potent. In-circuit component tester, such as Fault-finders' FF101 checks components mounted on printed-circuit boards. It checks components for short, opens, and out-of-tolerance values. It also detects reversed diodes and polarized capacitors.

8. Dedicated. General Radio's 1792 logic-board tester contains both stimulus and measurement capabilities. Optional software, highlighted by a potent diagnostic technique, rounds out the testing package.



TABLE 1. THE ROAD TO AUTOMATED TESTING — A COST COMPARISON

	PRESENT — MANUAL TESTING	PROPOSED — AUTOMATED TEST COST	REMARKS
SET UP	\$ 15,000	\$ 0	Manual testing covers time to collect and assemble test set up. There is no set up charge with automatic testing because programming is done by software in a few seconds.
TEST	500,000	8,333	Demonstrates approximate 60 : 1 savings in labor by going to automatic testing.
TROUBLESHOOTING	300,000	37,500	Troubleshooting in automated testing roughly 1/10 that in manual testing. Assumes 30% of the boards fail.
SET UP (RETEST)	4,500	0	Same as set up.
RETEST	150,000	2,500	Same as test.
DEPRECIATION	30,000	60,000	Manual testing uses 30 test fixtures depreciated over five years. Automated testing assumes one automatic system, also depreciated over five years.
TEST PROCEDURE/ PROGRAMING	48,000	100,000	Manual: 12 hours to write a test procedure. Automatic: 25 hours to write and debug a test program.
TOTAL	\$ 1,047,500	\$ 208,333	

Note: Table is based on 1,000 boards per week for one year; 200 board types mounting 20 to 30 ICs; approximately equal quantities of digital, analog, and hybrid (digital-analog) boards; and 130-pin pc-board connections; majority of analog and hybrid boards have potentiometer adjustments.

chines in the field. He says that they have a negligible down time that typically does not exceed 5%.

Speeds for the Fixit model 706 range from four to 45 tests per second, depending on the nature of the test. Large capacitors, of 100 picofarads and above, require the longer test times, while simple continuity tests can be performed at rates of 40 to 45 per second. In-circuit component testing in combination with function testing is offered by Zehntel.

Testing subsystems

Once component tests have been performed and defects corrected on the pc board, it's time to power up the board and test it on the same equipment as a subsystem. Components now are run through their circuit functions. If both incoming and in-circuit testing have been performed, failures amount to only a small fraction of the number that would occur if those tests had not been performed. Nonetheless, board testing is crucial and today represents a major automated-testing effort in manufacturing plants throughout the world because pc boards are the basic building blocks in all electronic products.

Failure to test thoroughly can lead to some unusual field failures. Design errors in computers have been de-

tected long after the equipment was shipped. In one instance, the equipment was well along in its life cycle before a subroutine was executed for the first time, and the computer could not perform it successfully.

Testing digital boards effectively on automated testers depends heavily on the test pattern delivered and the capability to diagnose failures according to responses to the test patterns. Test patterns must exercise the board fully, which means that every gate must be toggled, and every logic sequence possible must be executed. Second, there is the matter of adequate fault coverage, which means that the test must identify all the faults that may occur on a given board.

Some years ago, a popular test for a new digital board was to substitute it physically for a presumably working board in operating system. The advantage of this technique is that it requires virtually no setup costs to begin testing. However it requires dedication of a final product for test purposes. But, the disadvantages are numerous. Board substitution as a method of test requires lengthy troubleshooting time and usually requires highly trained personnel. Moreover, there is no diagnostic capability, and the tests seldom check the board thoroughly.

Troubleshooting has as its jumping-off point the com-

parison of a board's responses to sequences of test patterns with what are thought to be the correct responses. The correct responses may be based on a known good board or on a software simulation of the circuit.

There are several ways that the output from the unit under test can be evaluated. The simplest way is a go/no-go approach, which can take the form of comparing all outputs for a given test number with the correct responses stored in a look-up table. Lack of coincidence in any test means that the unit is malfunctioning. Another approach is to count transitions. As test patterns are applied to the board, some output pins will switch from 0 to 1, or 1 to 0. These transitions are summed in a counter, and the sum is compared with the value expected for a good board.

Choosing software

Crucial to computer-based systems is the software, not only to program tests, but also to perform diagnostics. A potent diagnostic can troubleshoot a complex logic board in a small fraction of the time it would take a good technician armed with scope and schematic.

In its simplest form, a diagnostic program stores a list of defects that could cause a malfunction at any specific numbered test. However, this approach may have little value because the list of possible defects at any test number may be enormous.

A second approach is to use a lookup table that stores for each test number all the right and wrong responses. It also contains a list of all the malfunctions that might cause each incorrect response pattern at that test number.

Unfortunately, such a look-up table requires great quantities of random-access bulk storage. Consider a circuit in which 2,500 faults might occur. This might be typical for a network with about 120 ICs and about 200 output pins at the edge connector. A typical test designed to identify 98% of the faults might require 500 tests.

An entry in the look-up table must be provided for each of the 2,500 faults at each of the 500 tests. And since it is assumed that there are 200 external output pins, then the full fault dictionary would contain $2,500 \text{ faults} \times 500 \text{ tests} \times 200 \text{ pins} = 2.5 \times 10^8$ bits. For a typical computer, that translates into almost 10 million words of storage. This demands a large and costly memory.

Some fault dictionaries, such as those that Mirco provides for many companies, in addition to its own 500-series tester, overcome the storage problem by storing only the first failed test results for each simulated fault. Mirco Systems Inc., Phoenix, Ariz., claims that this technique has the advantage of handling most multiple and intermittent faults better than exhaustive fault dictionaries.

General Radio claims to have drastically reduced the requirements for bit storage without sacrificing fault resolution. Its automatic fault-location software package, announced last spring, develops a small dictionary of faults that records a fault the first time a node fails a test, but ignores the same fault in the node uncovered in subsequent tests. The company claims the software can

Fault diagnosis—the GR approach

Unlike fault tables that store all faults that occur in all tests for all output pins, General Radio's software causes the memory to store only the output pattern for the first test at which a failure causes an incorrect output pattern. Assume that IC 7's pin 1 is stuck high and would first show up as a failure at test 7. This fact would be stored. The fact that this defect also causes tests 30, 32, and 34 to fail would not be stored. This reduces storage requirements drastically. For a circuit with a capability to develop 2,500 distinct faults and having 200 output pins, $2,500 \text{ faults} \times 1 \text{ test} \times 200 \text{ pins} = 500,000$ bits or about 42,000 words of computer storage would be required—at least two orders of magnitude less than a full fault dictionary.

During actual testing, the GR program generates the remaining data required for diagnosis of a particular circuit card on line via simulation. Thus, the full diagnostic resolution inherent in a test program is preserved while, at the same time, storage requirements are kept manageable.

The reason that all fault signatures for all tests are unnecessary is that, once a fault has manifested itself, the tester will model the suspected fault in software to confirm or deny that it is actually the cause of the malfunction.

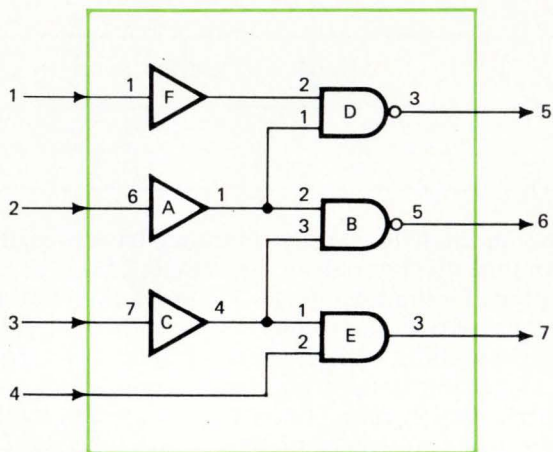

(a)

F1: A. 1 - 0 1st SOFTWARE SIMULATION

TEST NO.		1	2	3
INPUT PINS	1	0	0	1
	2	0	1	1
	3	0	1	1
	4	0	0	1
OUTPUT PINS	5	1	1	1
	6	1	1	1
	7	0	0	1

(d)

tion. For instance, a fault that first occurs at test 10 might also cause a malfunction at tests 75 and test 329, but no purpose is served by storing this fact in software. All the required diagnostic data will be regenerated by the simulator.

The diagnostic file then contains, for each test step, the faults that are first detected at that step, as well as the logical values that are observed at the external pins in the presence of a fault at the test step. Faults with identical first-failing test patterns are grouped together and called a fault group. In other words, members of a fault group are faults that develop identical output patterns up to and including the first failing test step.

As an example, assume that three test patterns are applied to the logic circuit shown in (a) and test No. 2 fails. The board has failed test 2 because the output is 110, not 100, as expected and shown in (b). Note that any of the faults, F1 A.1-0 (read pin 1 of device A stuck at zero), F2: C.4-0, or F3: B.5-1 could cause this fault pattern. (Collectively, F1, F2, and F3 are a fault group and are listed in c.)

A conventional dictionary look-up table would end at the first failing test (test No. 2); however, the GR system begins its fault-isolation routine here. The suspected

faults are now injected into the simulator, which looks for a match—not just down to the first failing test—but all the way through the test program.

In other words, the tester simulates each fault, F1, F2, F3, in software—one at a time. For each fault, it runs through the entire test program to compare the expected outputs of the board. When the fault behavior of the software model matches exactly the behavior of the board, then the fault has been identified.

The fault classes can be modeled F1: A.1-0, F2: C.4-0, and F3: B.5-1, as shown in (d), (e), and (f). Thus, the tester first simulates in software pin 1 of device A stuck at zero. It now applies the same test patterns as before to a software model of the board. Then it compares the simulated output with the actual output obtained in all tests—three in this example—for coincidence in all tests. It finds coincidence only for F3, hence the failure must be caused by pin 5 of device B stuck at 1.

What makes the technique potentially so powerful is that the simulation employs all the test patterns and all the resultant outputs and seeks coincidence between the modeled output and the actual output of the defective board. These operations can be performed on a 50-IC board with 200 test steps in less than a minute.

TEST NO.		1	2	3
INPUT PINS	1	0	0	1
	2	0	1	1
	3	0	1	1
	4	0	0	1

CORRECT SOFTWARE PATTERN				
OUTPUT PINS	5	1	1	0
	6	1	0	0
	7	0	0	1

INCORRECT HARDWARE PATTERN; FAILS TEST 2				
OUTPUT PINS	5	1	1	0
	6	1	1	1
	7	0	0	1

(b)

SUSPECTED FAULTS:

- F1: A.1-0
- F2: C.4-0
- F3: B.5-1

(c)

F2: C.4-0 2nd SOFTWARE SIMULATION

TEST NO.		1	2	3
INPUT PINS	1	0	0	1
	2	0	1	1
	3	0	1	1
	4	0	0	1
OUTPUT PINS	5	1	1	0
	6	1	1	1
	7	0	0	0

(e)

F3: B.5-1 3rd SOFTWARE SIMULATION

TEST NO.		1	2	3
INPUT PINS	1	0	0	1
	2	0	1	1
	3	0	1	1
	4	0	0	1
OUTPUT PINS	5	1	1	0
	6	1	1	1
	7	0	0	1

(f)

localize defects to within an average of 1.5 devices on a board (see "Automatic fault location—the GR approach," p. 104). The program is written in assembly language for the PDP-8/E used in the General Radio 1792 tester.

Two classes of software are associated with automated test equipment. The first kind, generated only once for each test system (usually supplied by the test-equipment manufacturer), includes all the necessary instructions for setting up stimulus-measurement devices and provides for the required switching to the unit under test. Depending on tester configuration, this software can also be partially hard-wired.

The second kind, usually generated by the system manufacturer himself, is sometimes referred to as application software. It is prepared once for each board type to be tested. It consists of information similar to that contained in conventional manual-test procedures in that it includes input- and output-signal requirements and allowable tolerances for the unit under test.

Vendors of automatic test equipment sometimes offer a high-level test language in English that can be easily learned by test and design engineers in a matter of days. Unfortunately, there is a lack of standardization of these languages in the industry, but this drawback is not severe, since most are similar (many are based on Atlas or Basic language) and can be learned quickly. To develop such a language requires a large programming investment. But the benefits are passed on the purchaser by vendors of automated test equipment, who amortize the cost through sale of many systems.

Comparing board-testing hardware

It's difficult to generalize about automated test equipment, especially testers for pc boards and subsystems. Some of these testers can also be used for incoming testing of components. Some manufacturers sell fully dedicated systems, which usually include the signal sources and measuring instruments. Test-pattern and diagnostic software or firmware may be included.

Other vendors sell general-purpose systems that provide the basic control functions that leave the customer the option of choosing the signal sources and the instruments for sensing and measuring the responses of the unit under test. They may or may not provide test-pattern and diagnostic software. Accordingly, some of the best known pc-board and subsystem testers are described individually rather than categorized.

General Radio's 1792 logic-board tester is a dedicated tester containing all stimulus and measurement modules within the cabinets as shown in Fig. 8. Its software program, called CAPS (for computer-aided programming software) is provided as an option. In addition to the fault-location capability provided by the software, a computer-guided probe is also supplied as a diagnostic aid.

However, neither diagnostic approach requires a known good board because software simulation supports both troubleshooting approaches. The 12-inch screen of the CRT can display the program, a page at a time, each with a maximum of 23 lines of 80 characters. A test program may be prepared through the keyboard

and then be stored on a disk, magnetic tape, or paper tape.

The series 390 general-purpose system, made by Instrumentation Engineering Co. in Franklin Lakes, N.J., has been purchased by such companies such as RCA, Xerox and ITT in the U.S., and overseas by Siemens and ITT Europe. Paul Giordano, president, points out that IE spent the largest part of its investment dollars for development of software for its System 390.

Table 1 shows cost savings projected by IE for a test program for 1,000 boards per week. Note that the total projected costs (\$208,000) are about 20% of those for a manual testing operation.

"We feel that the customer is best equipped to select the stimulus and measurement instruments which best suits his needs," says Giordano. "What we have done is assumed responsibility for the high-risk portion—that's the automation."

Handling other tasks

Giordano says his system can serve other functions beyond manufacturing tests. "The program used for in-house testing can become a vital tool for field-servicing. Thus, if the program is shared with the field service group, testing in the field comes 90% for free. Another virtue of our system is that the printout of the test data can serve for quality-control sign-off. In fact, there are situations in which we can justify the cost of our test equipment, based solely on its contribution to quality control," says Giordano.

"Hang a modem on our system, and it can share its data with any other system anywhere in the world. It is flexibility and versatility such as this which enables our system to compete with the dedicated systems," concludes Giordano.

Ince of Sycor says his company was attracted to the IE system because of its ease of programming, its adaptability to testing analog boards, and its modularity. Says Ince: "The IE system has helped to reduce our average troubleshooting time from 14.5 minutes per board to 8.6 minutes per board. Another significant factor is that we have reduced our failures at final assembly by 50%" because failures are being caught at an earlier stage.

Zehntel designs test systems with an eye to relieving the user of the software burden. One system, the Testpac III, is aimed at testing analog devices such as digital panel meters and telephone modules. Price ranges from \$20,000 to \$30,000. Says James Oenning, regional manager for Zehntel: "We put our money into a hard-wired computer controller, so there is none of the excess baggage associated with using a minicomputer. Our system has only 26 high-level instructions. However, our customers seldom require more than 10 or 11 or them.

"We provide program and control and let our customers pick the instruments. However, one instrument which couldn't be bought is a benchtop in-circuit measuring instrument. Thus, we came out with our Z Option. With it, a user can test at the nonfunctional level and catch defects as the boards come off the wave-soldering machine. This is where 90% of the defects on a board can be caught. Clearing manufacturing and as-



9. No software. The microprocessor of the Technology Marketing series 2000 tester is permanently programmed so that the user does not require any particular software. The operator enters the test procedure through switches and controls on the front panel. The procedure may then be stored on a magnetic card. Up to 700 test steps can be performed at a testing rate of 33 steps per second.

sembly problems means cleaning up solder splashes, reversed diodes, ICs, and polarized capacitors. Then the unit can be functionally tested on the same system.”

Another company that has avoided the software route is Technology Marketing. Its series 2000 tester (Fig. 9) employs a microprogramed computer for test routines, error analysis, and program generation. By

avoiding a language or any other software as a means of interfacing with the equipment, special training of personnel is virtually eliminated. The tester captures the correct responses from a known good board. Programs to compare these responses are contained on magnetic cards, each of which can store 16,000 bytes of program.

Caelus Memories, San Jose, Calif., which builds disk

Testing vs not testing: the costs

There are cost factors on both sides of the to-test-or-not-to-test decision. In dollars, the cost per device purchased or not testing is:

$$T = RPC + RDWF$$

where R is the percentage of total devices that are defective, P the percentage that fail in-plant, C the average cost of in-plant repair, D the percentage of defective devices that are long-term risks, W the percentage of those that fail during warranty, and F the average cost of in-warranty field repair per defective device.

For example, using some typical costs and risks, if 1% of the ICs purchased are defective (R), 75% of these are likely to fail in-plant (P), incurring an average cost of \$10 for in-plant repair (C). Then, say that 25% of the defective ICs are long-term risks (D), with half failing during warranty (W), resulting on an average cost of \$100 per defective device for in-warranty field repair (F). Then:

$$T = (0.01 \times 0.75 \times 10) + (0.01 \times 0.25 \times 0.5 \times 100)$$

That works out to 20 cents per purchased IC, or \$10,000 a year for a company that uses 50,000 ICs annually.

The break-even point, where the cost of testing is equal to the cost of not testing, can be found from:

$$TN = P + N(L/H)$$

where T is the per-device cost of not testing, N the annual consumption of devices, P the price of test equipment, L the labor cost in dollars per hour, and H the number of units tested per hour.

Rearranging, the annual consumption of devices that will justify 100% incoming inspection is:

$$N = P/(T - L/H)$$

Using conservative numbers—labor costs, including overhead, of \$10, throughput of 500 units, and one-year amortization of \$8,000 in test equipment—the break-even point is about 44,000 ICs per year. If the company's device usage turns out to be higher than this, testing would be a more cost-effective route than nontesting.

drives, tests the electronics for the drives on the series 2000 tester. Al Matej, manager of test engineering at Caelus, explains how automated testing was cost-effective for the company: "We wanted to use lower-skill technicians to do tests. By going to the Technology Marketing series 2000 tester, we no longer required a technician to test, but could employ a lower-skilled operator.

"We found that programing a microprocessor-driven tester meant that a technician, not a programmer, was able to program the tests. Admittedly, a microprocessor's clock time is in the millisecond range—not microseconds, as is the computer's. But in many of our tests, there are time-outs where the computer would stand idle. If board tests are about a minute long, then the difference in test time is almost unnoticeable."

There are many important applications for automated test equipment outside the realm of go/no-go

testing and diagnostics. As an example, Western Electric Co. in North Andover, Mass., was faced with testing a sophisticated oscillator for short- and long-term stability. After sample test runs on each oscillator, extensive calculations were necessary to determine the value of a select-at-test resistor. Three years ago, Western Electric bought a Hewlett-Packard Co. model 9500 automatic tester and programmed it to do the job.

"We were able to cut test and calibration time from several hundred hours down to 15 to 20 hours," says Ted Danglemeier, a Western Electric development engineer. The system is designed to automatically compute the temperature-deviation data and then print out the resistor value required to provide the necessary compensation.

H-P, Palo Alto, Calif., guarantees that its recent entry into the automated test-equipment market, the HP 9510D, will deliver performance where it really counts—at the interface connector where the unit under test is attached. The system will test dc and ac voltages, resistance, and distortion—phase, digital, and pulse—in the frequency range from dc to 500 MHz.

As with any computer-oriented system, automated testing lends itself to multiplexing. As an example, the Texas Instruments ATS-960 automated test system, which its Digital Systems division, Houston, built around TI's 960A computer, can accommodate up to four test stations.

While one of the system's stations is doing fault isolation on a digital board, a second may be doing go/no-go testing on analog boards, a third may be debugging a test program, and a fourth is being used for incoming inspection on integrated circuits. The ATS-960 is essentially a general-purpose system and can interface with a variety of stimulus and response instruments that have remote control capability.

The tester can check high-complexity boards at a 20-kHz pattern rate and is able to test digital, analog, or hybrid assemblies, which contain both analog and digital circuits. A diagnostic is developed by having the tester memorize the response at every node of a known good board. The data is then stored on disks. In the event of a failure, a probe is used to guide the operator, node by node, back to the malfunctioning device and thereby isolate the defective component.

Testing in the field

Field support is vital to customer good will and follow-on sales, and putting quality automated testers at field-service stations almost assures worthwhile rewards. Service personnel often have a low level of confidence in a board repaired at the factory and returned to him as a spare. Turn-around time is often long. Returned boards compete at the factory with boards on the production line, and since the latter compete with products that can be shipped and billed, boards from the field are frequently sidetracked.

Because of long turn-around times, the service man often orders a large backlog of spares, since he can't risk having to wait for factory returns. Frequently, he doubts their worth when they do come back.

Against this background, it isn't hard to realize that

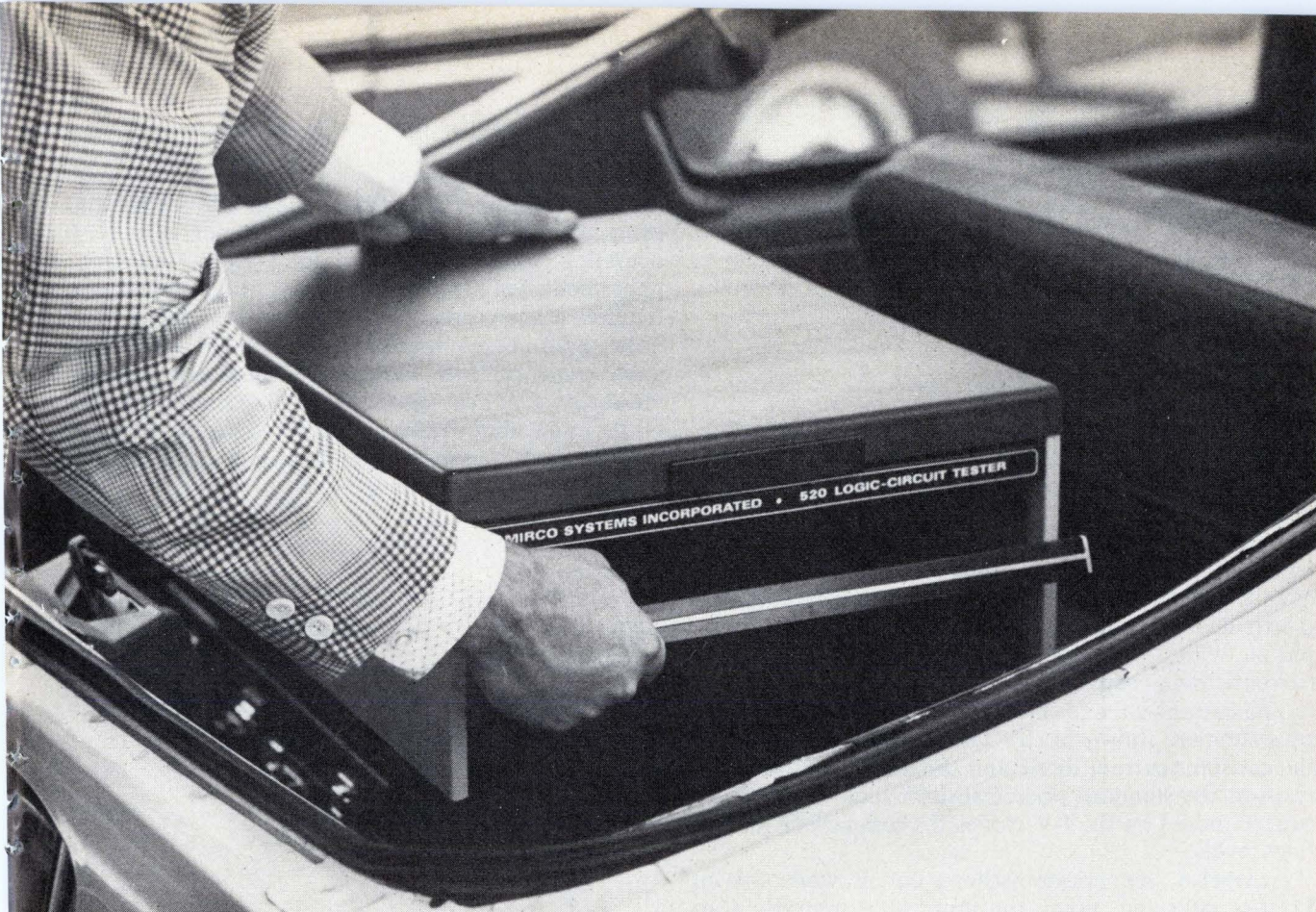

10. Tester for the road. Mirco's series 500 tester can provide field-service personnel with a potent portability advantage in the testing of logic circuits. The tester can be programed at the user's discretion with both programed and pseudorandom test patterns.

putting a tester in the field is likely to pay for itself. The field-service man can then test and repair every board that is defective. His confidence is 100%—after all, he repaired it. He cuts back by perhaps 80% the number of boards he returns to the factory. Thus, he rids the mails of an enormous float—boards that are neither on his spares shelf nor in operating equipment—and so are serving no worthwhile purpose.

One tester that promises both field and in-house testing is the 500-series logic-circuit tester made by Mirco (Fig. 10). With a price tag of \$6,000 to \$18,000, depending on various options, it is claimed to provide test performance more common for testers in the \$30,000 to \$60,000 range.

Mirco's tester combines both programed and non-programed (pseudorandom) test patterns. Programed test patterns are important to initialize sequential-logic circuits. Pseudorandom test patterns can exercise circuits at a lower setup cost than can a manually generated test program.

The series 500 tester enables a user to employ a variety of diagnostic techniques. He may employ fault dictionaries, effective for rapid identification of defective ICs and short circuits between adjacent pins, or he may use a probe to trace a fault back to its cause. Transition counting is also available.

Another tester that is being aimed at field-servicing is Technology Marketing's model 2080. A test program developed in-plant can be prepared on a magnetic card

and mailed to the field for use on this tester.

Some equipment manufacturers have large in-house test development capability and choose to build their own automatic test equipment. However, Fred Van Veen, of Teradyne, a test-equipment manufacturer, says, "We can accumulate more experience faster because we interface with many companies."

Fred Pffiferling, manager of production programs for RCA, Moorestown, N.J., agrees. He says that if a piece of automated test equipment from a reputable manufacturer precisely meets a user's requirements, it is usually better to purchase the equipment.

Advantages of purchasing include a lower price than a system built in-house because one-time software and hardware-design costs have been amortized over a number of systems, documentation is usually better systemized and of higher quality, and spare support is available.

In-house designs require a large test-engineering group of wide-ranging skills, and software is expensive, particularly if only one system is to be built.

But there are some advantages for the in-house design, concludes Pffiferling. "In-house designs can generate a greater pride of ownership with a resulting increase in efficiency. Also in-house designs usually are more flexible in regard to accommodating future changes and additions to the tester." □

Reprints are available for \$3 from Electronics Reprint Dept., P. O. Box 669, Hightstown, N. J. 08520. Copyright 1974 by Electronics, a McGraw-Hill Publication.

Two-component light sensor has high voltage output

by Thomas T. Yen
Statham Instruments Inc., Oxnard, Calif.

An output voltage of up to 50 volts can be developed by a light-sensing circuit that uses a constant-current diode as the load for a phototransistor. The circuit, which is drawn in (a), provides high noise immunity because its output remains relatively constant until the input light-level threshold is reached. Since the circuit can operate over a wide range of voltages, it is compatible with C-MOS devices. And, at high light levels, it is also compatible with TTL and DTL devices because of the high-current-sinking capability of its phototransistor.

The current-voltage characteristics of a typical phototransistor are shown in (b). The nonlinear load line of the constant-current diode and the linear load line of a resistor, the standard phototransistor load element, are superimposed on the I-V curves for comparison at four light levels.

At level A, the phototransistor is cut off, while at level D, it is saturated. When the input light intensity goes from intermediate level C to saturation level D, or vice versa, the change in the phototransistor's output voltage is far larger for the nonlinear load than for the linear load. In circuit (a), therefore, the output voltage remains high until the input light intensity is large enough for the phototransistor's light current to match the diode's pinchoff current. At this point the circuit's output voltage decreases abruptly and becomes the saturation voltage of the phototransistor.

When the input light changes from bright to dark, the circuit's output voltage rises slowly, as the constant current from the diode charges the phototransistor's collector capacitance. In this circuit, the charging time will be on the order of 100 microseconds. The output rise time can be shortened either by clamping the output to a lower final voltage or by using a diode with a higher current rating.

With the components shown, the circuit is limited to medium-speed (1 kilohertz) applications—for example, an event-counting sensor for industrial purposes. Faster operating speeds can be realized by substituting a photodiode for the phototransistor. But, a photodiode requires a low-current diode, one with a rating on the order of 20 microamperes, and such a constant-current diode is not currently available. Furthermore, integrating the constant-current diode and the phototransistor on the same chip would permit the circuit's risetime to be optimized, because device capacitance could then be minimized through the chip layout. □

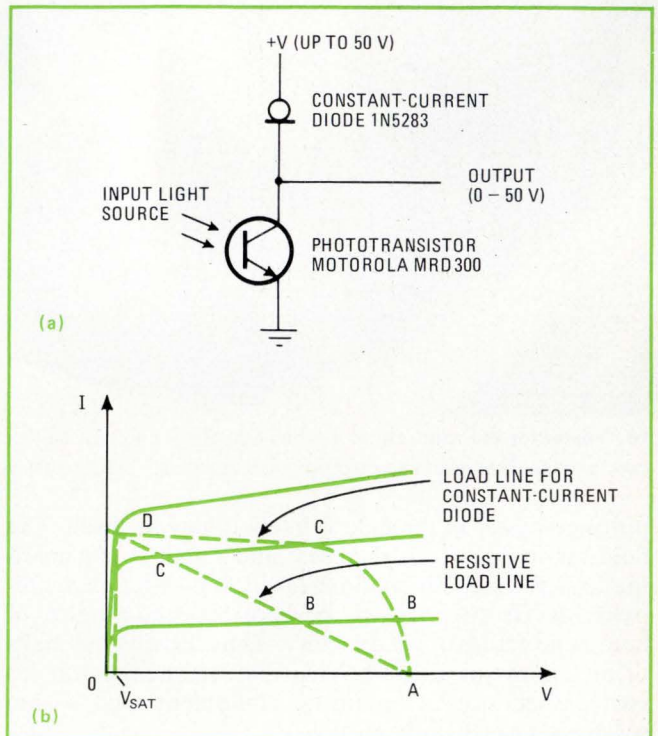

Light detector. Constant-current diode acts as a nonlinear load for a phototransistor so that the output voltage of this light sensor (a) remains high until the phototransistor's current equals the diode's pinchoff current. When the input light threshold is reached, the circuit's output switches to the saturation voltage of the phototransistor, as shown by the I-V curves (b) of a typical phototransistor.

Coding a-d converters for sign and magnitude

by William D. Miller
Hybrid Systems Corp., Burlington, Mass.

Successive-approximation analog-to-digital converters that provide a sign/magnitude type of output coding are not only hard to come by, they also tend to be

costly. In a sign/magnitude-coded output, the output bit values are identical for either positive or negative inputs of the same magnitude, and an extra bit (a sign bit) is used to distinguish between the two input polarities. A fairly simple circuit can be used to develop sign/magnitude output coding for either a unipolar converter or a bipolar converter having an offset-binary-coded output.

For the unipolar converter, an analog circuit (a) consisting of a sign-bit amplifier (or an equivalent absolute-value network) and an analog comparator is placed at the input end of the converter. The circuit maintains the

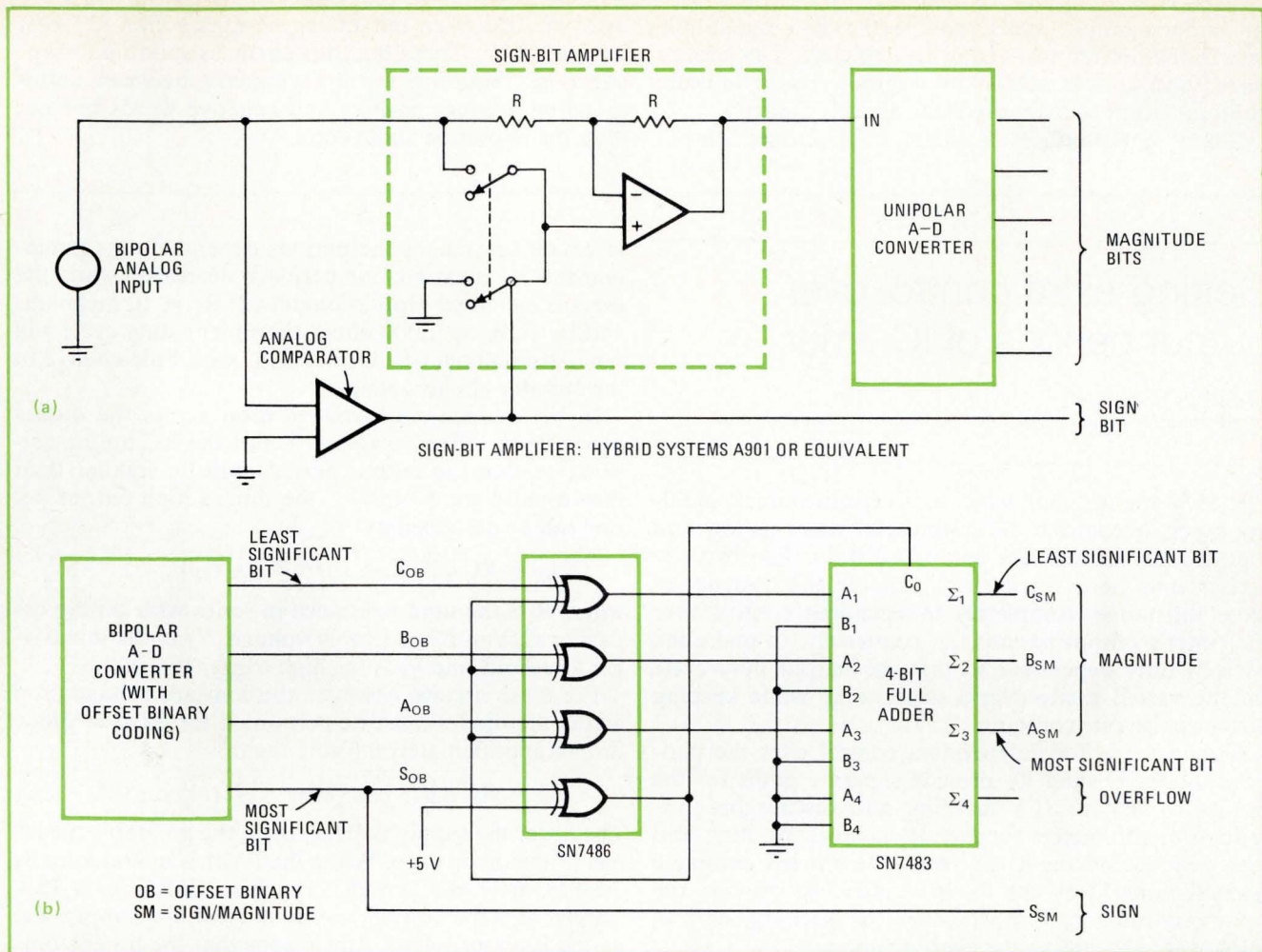

unipolar input to the converter to preserve the magnitude information, while the sign information is generated on a separate line.

Besides accommodating any unipolar code, this approach provides the zero-plus and zero-minus codes that occur within $\pm 1/2$ least significant bit of the true zero input. Parts cost for the circuit, however, is rather high—in the range of \$30.

A more economical digital approach (b) can be used if the a-d converter is one of the readily available bipolar types having an offset-binary-coded output. Exclusive-OR gates and full adders are the logic elements needed to convert from the offset binary code to the sign/magnitude code. With this technique, parts cost is only \$5 or so for a 12-bit converter.

The figure shows a representative four-bit system. The table compares the offset binary and sign/magnitude codes for the 16 corresponding digital output words. For words 1 through 8, each bit in each code is identical. For words 9 through 16, one code is the two's complement of the other code. For clarity, the most significant bit of each code is assumed to be the same for the same word.

For words 9 through 16, the exclusive-OR gates translate the offset-binary-coded output bits from the converter to a one's complement code. These gates also develop the carry-in bit for the four-bit adder. Three of

CODE CONVERSION

WORD	FROM OFFSET BINARY				TO SIGN/MAGNITUDE			
	S _{OB}	A _{OB}	B _{OB}	C _{OB}	S _{SM}	A _{SM}	B _{SM}	C _{SM}
1	1	1	1	1	1	1	1	1
2	1	1	1	0	1	1	1	0
3	1	1	0	1	1	1	0	1
4	1	1	0	0	1	1	0	0
5	1	0	1	1	1	0	1	1
6	1	0	1	0	1	0	1	0
7	1	0	0	1	1	0	0	1
8	1	0	0	0	1	0	0	0
9	0	1	1	1	0	0	0	1
10	0	1	1	0	0	0	1	0
11	0	1	0	1	0	0	1	1
12	0	1	0	0	0	1	0	0
13	0	0	1	1	0	1	0	1
14	0	0	1	0	0	1	1	0
15	0	0	0	1	0	1	1	1
16	0	0	0	0	0	1	1	0

← OVERFLOW AT Σ₄ →

Simple conversion. Analog circuit of (a) enables a unipolar a-d converter to accept bipolar inputs and produce a sign/magnitude-coded output. A sign-bit amplifier or an equivalent absolute-value network performs the polarity selection. The digital circuit of (b) translates the offset-binary-coded output of a bipolar a-d converter to a sign/magnitude-coded output. A four-bit system is shown here.

the adder's output sums provide the sign/magnitude data in the desired two's complement code. The adder's fourth output sum acts as an overflow bit to indicate when the input count exceeds the adder's capacity.

Circuit (b) produces a single nonpolarized output

word of 1000 when the analog input is within $\pm 1/2$ least significant bit. Therefore, this circuit is suitable for applications requiring mirror symmetry between corresponding nonzero positive and negative words but not ultrafine resolution about zero. □

Getting extra control over output periods of IC timer

by Arthur R. Klinger

United States Air Force, Sheppard Air Force Base, Wichita Falls, Texas

The 555-type IC timer, which is a versatile circuit building block, becomes even more useful when its low and high output periods are controlled fully. The two circuits shown here, for example, enable the designer to have full-range, completely independent control over the timer's output periods, or, conversely, to make the periods fully dependent so that the output duty cycle can be varied easily over a wide range while keeping output pulse rate constant.

Circuit (a) is for independent control over the periods. Diodes D_1 and D_2 provide separate paths for the timing capacitor's (C) charging and discharging currents. Potentiometers R_1 and R_2 control the high and low periods independently over the timer's complete normal range. Resistor R_3 is included to provide the same minimum fixed resistance in the discharge loop as resistor R_4 provides in the charging loop.

When $R_1 = R_3$ and $R_2 = R_4$, a single calibrated dial can be shared by potentiometers R_1 and R_2 (through a concentric control). If $R_1 = R_2 = 10$ megohms and $R_3 = R_4 = 1,000$ ohms, the ratio of high-to-low or low-to-high periods can approach 10,000:1.

Circuit (b), which is only a slightly modified version

of circuit (a), makes the periods dependent. As potentiometer R_1 is varied, one period is decreased while the other is increased proportionately. If $R_1 = 10$ megohms and $R_2 = R_3 = 1,000$ ohms, the timer's duty cycle will range from about 0.01% to 99.99%, with little change in the output pulse frequency.

In both circuits, the voltage drop across the diodes decreases the effective voltage across the RC timing network, so that the output periods will be smaller than they usually are. Normally, the timer's high output period can be described by:

$$T_{HI} = RC \ln[(V_{CC} - V_1)/(V_{CC} - V_2)]$$

where R is the total resistance in series with timing capacitor C, V_{CC} is the supply voltage, V_1 is the low trigger threshold, and V_2 is the high trigger threshold.

For these circuits, however, the constant voltage drop across the diodes must be accounted for. If each diode drop is approximately 0.6 volt, then:

$$T_{HI} = RC \ln[((V_{CC} - 0.6) - V_1)/((V_{CC} - 0.6) - V_2)]$$

The lower the supply voltage, then, the greater is the effect of the diode drop. When the timer is operated in its astable mode, the period is roughly $0.76RC$ for a 15-v supply, and for astable operation with 5-v supply, the period is about $1.4RC$. This means that the timer's output periods will be more sensitive to variations in the power-supply voltage, which may be a disadvantage in some applications. □

Designer's casebook is a regular feature in Electronics. We invite readers to submit original and unpublished circuit ideas and solutions to design problems. Explain briefly but thoroughly the circuit's operating principle and purpose. We'll pay \$50 for each item published.

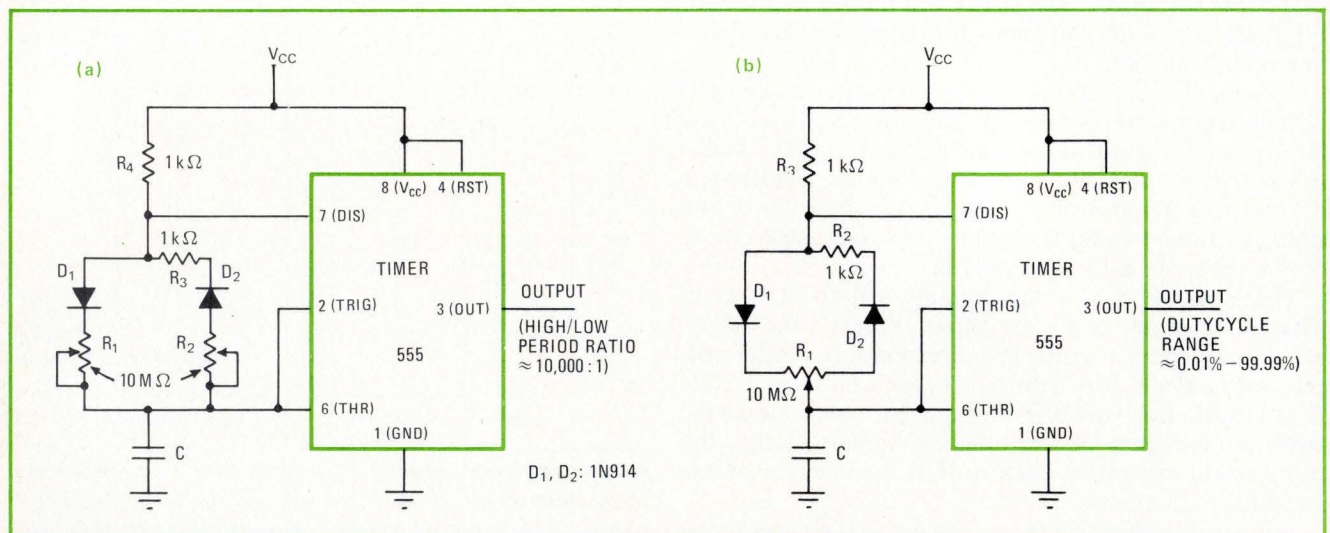

Simple but effective. When a pair of diodes is used to separate the charging and discharging paths of an IC timer, the high and low output periods of this device can be controlled easily. The periods can be made independent of each other, as in (a), or fully dependent without changing the output pulse frequency, as in (b). The diode drops, however, make the timer more sensitive to supply variations.

SIEMENS

Cost-Effective Solutions to Semiconductor Test Problems

APPLICATION:

Verification of semiconductor memory performance from device to system level.

WHAT TO LOOK FOR IN A TESTER:

High speed microprocessor.
Independent X & Y addressing.
Off-the-shelf device interface.



COMPUTEST MODEL 901

Semiconductor testing demands a practical low-cost solution. To check performance of semiconductor memory from the device through the system level requires memory-oriented addressing capability, a stable clock system, performance compatible device interface and real-time error detection. It's all found in the Computest Model 901 bench top memory tester.

The Computest 901 has an easy-to-use, 10 MHz microprocessor, independent X & Y address generator, and a flexible, multi-channel clock. A complete inventory of RAM/ROM interface modules puts the 901 to work for you immediately.

The Computest 901—flexible, versatile, tailored in price and performance for semiconductor memory testing from device to system level.

FREE!

Send for the Computest catalog of Semiconductor Test Equipment and our Semiconductor Program Library



NAME _____
COMPANY _____
ADDRESS _____
CITY _____
STATE _____ ZIP _____

For applications assistance, contact:

John Lalley, (609) 424-2400

Siemens Corporation
Electronic Systems Division
Computest Products

3 Computer Drive, Cherry Hill, N.J. 08002 (609) 424-2400



A new series

MODELING *the* **bipolar** **transistor**

by Ian Getreu, Tektronix, Inc., Beaverton, Ore.

In many applications, computer-aided design is the best approach to analyzing a circuit containing bipolar transistors. But the available transistor models on which any CAD analysis must be based can appear confusing to their would-be user on several counts.

He has to decide which of several bipolar transistor models is best for his purposes. To make that decision, he must be familiar with the different notations used by various models, since a single standard notation does not exist. He even has to decide how to measure the parameters needed to describe his model, since again no standard methods of measurement exist.

At this point, the circuit designer may well wonder whether the difficulties of using CAD do not outweigh its advantages as a cheap and fast method of breadboarding. But the problems of modeling the bipolar transistor are not insurmountable, and CAD's real usefulness is far greater than is commonly realized.

CAD enables the designer of either discrete or integrated circuits to do things that are quite impossible with any other technique. For example, with the computer, the circuit designer can:

- Observe waveforms and frequency responses of voltages and currents without loading his circuit as a probe would.
- Predict the performance of an IC at high frequencies, whereas an actual breadboard introduces parasitics that are not present in the IC.
- Use selectively ideal devices, such as a transistor with an infinite bandwidth or a very large gain, to do blue-sky analyses, or to isolate the effects of various device parameters on circuit performance.
- Separate out his dc circuitry to understand the basic part of the circuit.
- Open a feedback loop without disturbing the dc levels.

- Determine the poles and zeros of a transfer function for normally prohibitively large circuits.

- Do noise, sensitivity, worst-case, and statistical analyses.

The many computer programs now available to the circuit designer allow him to perform a wide variety of analyses. The fact that just about every program seems to have a different format and different rules is troublesome, but information about them is readily available, and mistakes can be detected relatively easily by the computer, the program, or the user himself. A much greater problem is the lack of standard models for active devices, as in the case of the bipolar transistor.

In general, transistor models can be divided into two major groups—the linear ones for small-signal analyses, and the nonlinear ones for time-domain and large-signal analyses. The linear models are fairly well-documented and relatively easy to work with. Unfortunately, such is not the case for the nonlinear models.

This three-part series is intended to help even the inexperienced computer-user to select and describe the nonlinear model that best suits his application. In addition to showing how to model the bipolar transistor systematically, these articles present techniques for determining all necessary model parameters from terminal measurements of the device.

Part 1 of the series appears in this issue and covers the simplest nonlinear large-signal transistor model, which is called the first-level Ebers-Moll model. The theory behind this model, as well as definitive methods for measuring the model parameters, are included here. Part 2, which will appear in an upcoming issue, takes up the next level of model complexity, accounting for the first-order effects of transistor charge storage. Part 3 will discuss how to measure the parameters needed to specify this sec-

Part 1: First-level nonlinear model

Simplest large-signal equivalent is useful for dc analyses, as well as idealized simulations, and its parameters can be determined from direct measurements

ond-level model, which is also based on the Ebers-Moll equations.

In order to describe either of these nonlinear models completely, a computer program needs three types of information. They are the fundamental physical constants, the operating conditions, and the model parameters.

The constants, such as Boltzman's constant and electron charge, are normally defined inside the program.

The operating conditions establish the circumstances under which the model equations are to be used. In a nodal-analysis type of program, the operating conditions are normally the transistor's bias voltages, which are determined internally as the computer iterates to the solution. That is, the program assumes a set of bias voltages, solves the nodal equations, and then selects new and better values of the bias voltages at each iteration—this is all done internally.

The third type of program input needed is the set of model parameters for each different device in the circuit. The manner in which the values of the various model parameters are described by the user is predetermined by the program. Some programs are very flexible and allow some model parameters to be specified indirectly, in terms of other parameters. In this case, the program will compute the value of the indirectly specified parameter.

Finally, a distinction must be made between the model parameters and the program's input parameters. The model parameters are those parameters used in the model equations to describe the device being modeled for a given set of operating conditions. The input parameters, on the other hand, are those required by the program to specify the model parameters. Some or all of the input parameters may be model parameters, depending on the program.

Almost every model that simulates the nonlinear large-signal behavior of the bipolar transistor is based on the well-known Ebers-Moll representation.¹ Though in its basic form it applies to only ideal or dc transistor characterizations, it can be modified to bring the device simulation closer to actual transistor operation. But the price is greater model complexity.

Of course, the simplest model that will do the job should always be the one chosen. Unnecessarily complicated models, besides wasting man hours and computer time, make it harder both to understand the results of the analysis and to extract useful information from it.

The first-order effects of nonlinear charge storage are not covered by the first-level model described here in Part 1 but will be handled in Parts 2 and 3. Second-order effects, such as base-width modulation, which introduces a finite impedance, and variation of current gain with current level, need not be accounted for in many computer simulations,² and this series does not deal with them.

The first-level Ebers-Moll model is essentially a dc equivalent circuit because there is no characterization of transistor charge storage. All the models based on the Ebers-Moll representation are valid for all regions of operation, including the saturated, inverse, normal, and off conditions. The transistor's operating region is determined by its junction bias voltages (Fig. 1).

Choosing model notation

Currently, there are two popular versions of the first-level Ebers-Moll model. One can be called the injection version (Fig. 2a), and the other can be called the transport version (Fig. 2b). Mathematically, the two, which are both drawn for an npn transistor, are identical. It is not immediately apparent why one should be preferred over the other. However, the transport version is better for computer simulations because it is the simpler one for a computer program to use, and it is more readily

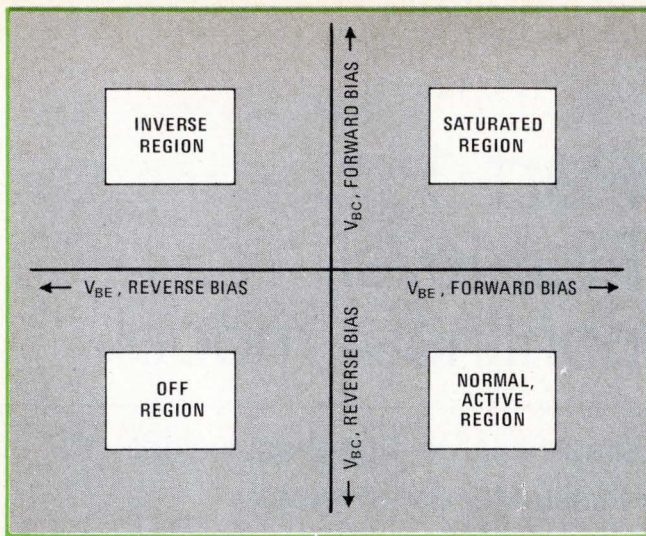

1. For reference. Four-quadrant representation of a bipolar transistor's operating regions clearly shows the effects of the device's base-emitter and base-collector junction voltage polarities.

modified for more complex modeling.³

The injection version is the original and better-known Ebers-Moll model. Its reference currents—those currents used to express all other currents—are the currents through the diodes. The reference forward diode current is:

$$I_F = I_{ES}[\exp(qV_{BE}/kT) - 1] \quad (1)$$

where I_{ES} is the emitter-base saturation current, V_{BE} is the base-emitter voltage, q is electron charge, k is Boltzmann's constant, and T is temperature. The reference reverse diode current is:

$$I_R = I_{CS}[\exp(qV_{BC}/kT) - 1] \quad (2)$$

where I_{CS} is the collector-base saturation current, and V_{BC} is the base-collector voltage. The collector terminal current can now be expressed in terms of I_F and I_R :

$$I_C = \alpha_F I_F - I_R \quad (3)$$

where α_F is the large-signal forward current gain of a common-base transistor. Similarly, the base terminal current can be written as:

$$I_B = (1 - \alpha_F)I_F + (1 - \alpha_R)I_R \quad (4)$$

where α_R is the large-signal reverse current gain of a common-base transistor. And lastly, the emitter terminal current becomes:

$$I_E = -I_F + \alpha_R I_R \quad (5)$$

A simple intuitive feel for the model can be obtained by inspection. The diodes represent the transistor's base-emitter and base-collector junctions. The I_F term is the current that would flow across the base-emitter junction for a given V_{BE} if the collector region were replaced by an ohmic contact. Current I_{ES} is the saturation current of this junction. Equation 1 yields the value of I_F for a given V_{BE} . Similarly, Eq. 2 describes the collector-base junction if the emitter were replaced by an ohmic contact, and I_{CS} is the saturation current of the collector-base junction.

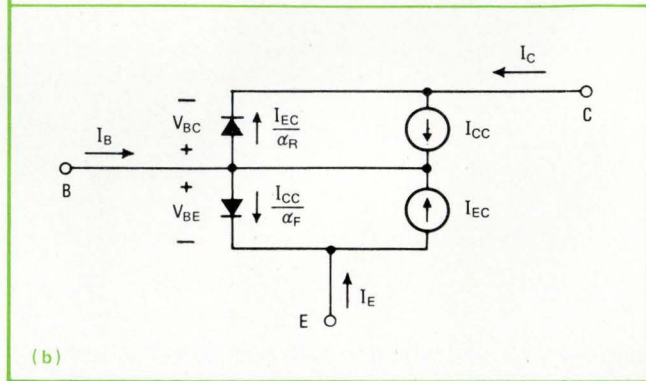
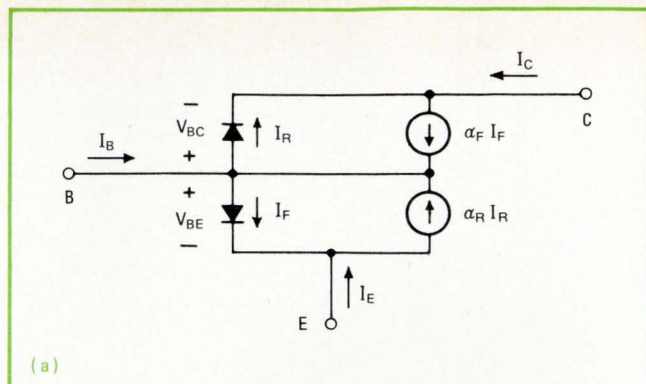

2. A difference in notation. The reference currents for the injection version (a) of the first-level Ebers-Moll model are the diode currents. All other model currents are expressed in terms of the reference currents. In the transport version (b), the reference currents are the two current sources. Either model can be specified with only three parameters—the two betas and the saturation current.

The two diodes alone, back to back, do not fully represent the transistor. Coupling between the junctions is physically provided by a very narrow base region and is modeled by the two current-dependent current sources. Suppose the transistor is biased in its normal active region (V_{BE} forward-biased and V_{BC} reverse-biased). Then, the collector-base diode can be approximated by an open circuit, and the model reduces to the $\alpha_F I_F$ current generator and the base-emitter diode, which is the often-used representation of a transistor operating in its normal active region.

Current I_F represents the total current flowing across the base-emitter junction, while α_F is whatever fraction of that current is collected at the base-collector junction. Similarly, when the transistor is operated in its inverse mode (V_{BE} reverse-biased and V_{BC} forward-biased), α_R is the fraction of the total current that is flowing across the collector-base junction and that is collected at the emitter-base junction.

With Eqs. 1 through 5, four parameters— I_{ES} , I_{CS} , α_F , and α_R —are required to describe the injection version of the first-level Ebers-Moll model at one temperature. The number of parameters can be reduced by one because the current gains and saturation currents are related by:

$$\alpha_F I_{ES} = \alpha_R I_{CS} = I_S \quad (6)$$

where I_S is the common portion of both the I_{ES} and I_{CS} saturation currents. A pn-junction saturation current

consists of two terms—a term from an analysis of each neutral region. Equation 6 simply means that the analysis of the base region for both I_{ES} and I_{CS} is the same and that saturation current I_S is the common component.

The constants α_F and α_R are related to the large-signal current gain of a common-emitter transistor:

$$\beta_F = \alpha_F / (1 - \alpha_F)$$

where β_F is the large-signal forward current gain of a common-emitter transistor. Likewise:

$$\beta_R = \alpha_R / (1 - \alpha_R)$$

where β_R is the large-signal reverse current gain of a common-emitter transistor.

Now only three model parameters are needed at one temperature—the ones normally used are β_F , β_R , and I_S . All the other model parameters (I_{ES} , I_{CS} , α_F , and α_R) can be obtained from these three.

Transport notation is better

The transport version of the first-level Ebers-Moll model differs from the injection version only in the choice of the reference currents. In the transport version, the reference currents are the model's current sources, I_{CC} and I_{EC} —they represent those currents that are collected. The reference collector source current can be written as:

$$I_{CC} = I_S [\exp(qV_{BE}/kT) - 1] \quad (7)$$

And the reference emitter source current is:

$$I_{EC} = I_S [\exp(qV_{BC}/kT) - 1] \quad (8)$$

These two reference currents can then be used to express the transistor's terminal currents:

$$I_C = I_{CC} - (I_{EC}/\alpha_R) \quad (9)$$

$$I_B = [(1/\alpha_F) - 1]I_{CC} + [(1/\alpha_R) - 1]I_{EC} \quad (10)$$

$$I_E = -(I_{CC}/\alpha_F) + I_{EC} \quad (11)$$

Mathematically, Eqs. 7 through 11 are identical to Eqs. 1 through 5. In these definitions, the dependence of the reference currents on the junction voltages is the same for both I_{CC} and I_{EC} . That is:

$$I = I_S [\exp(qV/kT) - 1]$$

where I is the reference current, and V the appropriate junction voltage.

Figure 3 shows the variation of the reference currents, for both the injection and transport versions, as a function of the appropriate junction voltages. For the injection version (Fig. 3a), two constants (I_{ES} and I_{CS}) are needed to obtain the reference currents (I_F and I_R). For the transport version (Fig. 3b), however, the curves for the collector and emitter reference source currents are identical. This means that the variation of both of these currents with junction voltage can be described by one fundamental constant— I_S . For given values of V_{BE} and V_{BC} , then, the transport version's two reference currents can be completely determined if I_S is known. This, together with the fact that the reference currents for the transport version are linear over many decades of a semilogarithmic plot (even for higher-order models), ac-

counts for the preference for the transport version over the injection version.

The difference between the injection and transport versions of the basic Ebers-Moll model only involves a change in notation, not a change in the form of the model. (The transport notation will be used here.) But, a change in model form can be helpful.

Simplifying model form

As shown in Fig. 4a, the transport model's two reference current sources can be replaced by a single current source between the collector and the emitter terminals. To do this, the equations for the diode saturation currents must be changed appropriately, along with the equation for the single reference current source, I_{CT} . The diode currents become:

$$(I_{CC}/\beta_F) = (I_S/\beta_F) [\exp(qV_{BE}/kT) - 1]$$

and:

$$(I_{EC}/\beta_R) = (I_S/\beta_R) [\exp(qV_{BC}/kT) - 1]$$

The model's terminal currents can now be written as:

$$I_C = (I_{CC} - I_{EC}) - (I_{EC}/\beta_R)$$

which is equivalent to Eq. 9, and as:

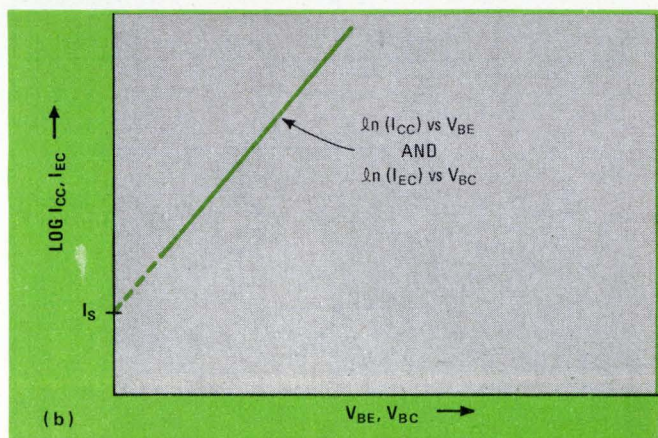
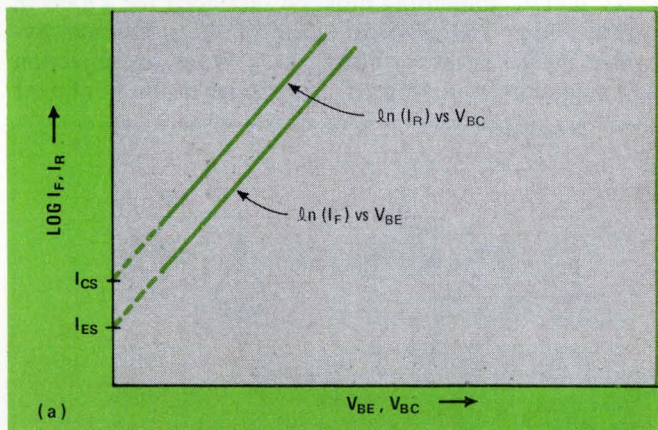

3. Transport model is preferred. Reference current as a function of junction voltage is plotted for both the injection (a) and transport (b) models. The transport model is the better choice, because each of its reference currents can be described by the same saturation current. The injection model, on the other hand, requires two saturation currents to describe its two reference currents.

$$I_B = (I_{CC}/\beta_F) + (I_{EC}/\beta_R)$$

which is equivalent to Eq. 10, and as:

$$I_E = -(I_{CC}/\beta_F) - (I_{CC} - I_{EC})$$

which is equivalent to Eq. 11.

There is a good reason for making this alteration. With the model form of Fig. 4a, the linearized small-signal equivalent circuit of a transistor operating in its forward active region reduces to the well-known linear small-signal hybrid- π model. As shown in Fig. 4b, the I_{CT} current generator becomes the g_m (transconductance) current generator. The forward-biased diode between the base and the emitter terminals becomes the r_π resistor ($r_\pi = \beta_F/g_m$). And the reverse-biased diode between the base and the collector terminals becomes the r_μ resistor, which is normally assumed to be an open circuit.

Because of this easy transition from a nonlinear model to a linear model, the equivalent circuit of Fig. 4a is conveniently called the nonlinear hybrid- π model. Its similarity in form to the linear hybrid- π model means that a computer program can perform the small-signal hybrid- π linearization with very little effort.

As always, something must be sacrificed for a gain in convenience. The physical sense of the nonlinear hybrid- π model is not as strong as it is for the injection and transport model forms. The diodes in the nonlinear

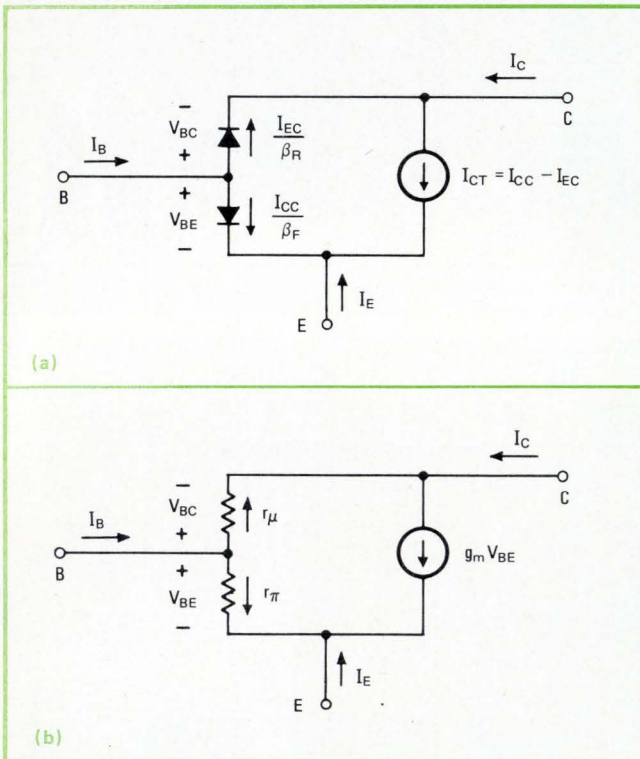

4. Changing model form. The nonlinear hybrid- π model of (a) is obtained by consolidating the two reference current sources of the transport model (Fig. 2b). The change in model form is strictly a matter of convenience. When the nonlinear hybrid- π model is linearized for a small-signal analysis in the forward active region, it easily reduces to the well-known linear hybrid- π model of (b).

hybrid- π model no longer represent the actual transistor pn junctions, and the diode currents now actually represent components of the base current. However, the change in model form does not affect the parameters required to specify the first-level Ebers-Moll model at one temperature—these parameters are still β_F , β_R , and I_S .

Adding temperature dependence

At the level of model complexity being considered here, parameters β_F and β_R are both regarded as constants, independent of current and voltage levels, as well as temperature. The only parameter that is assumed to change with temperature is I_S . This temperature variation is given by:

$$I_S(T) = I_S(T_{nom})(T/T_{nom})^3 \times \exp[(-E_g/k)((1/T) - (1/T_{nom}))]$$

where T is the analysis temperature (in kelvin), T_{nom} is the nominal temperature (in kelvin) at which the device data is taken, and E_g is the energy gap (in electronvolts) of the semiconductor material being used.

To account for the variation of I_S with temperature, then, two more model parameters— T_{nom} and E_g —are needed. In some computer programs, the value of E_g is internally fixed at 1.1 eV (that is, the semiconductor material is assumed to be silicon). In other programs, E_g is a model parameter that the user can specify. The size of the energy gap is not normally measured, but rather an appropriate value is chosen from a data table.

At this point, a brief review will help to summarize the important aspects of the first-level nonlinear bipolar-transistor model:

- For computer simulations, the transport model is a better choice than the injection model.
- At a given temperature, only three model parameters— β_F , β_R , and I_S —are needed to specify the model. Two additional parameters— T_{nom} and E_g —are required to model the variation of saturation current I_S with temperature. Because the first-level Ebers-Moll model is a dc model, β_F and β_R are dc parameters, not ac parameters. For the model complexity being discussed here, however, the distinction between ac and dc beta values is purely academic.
- A transformation from the transport model form (Fig. 2b) to the nonlinear hybrid- π model form (Fig. 4a) makes the computer linearization to the small-signal linear hybrid- π model (Fig. 4b) simpler.

All the model diagrams given here are for an npn transistor. For a pnp transistor, the voltage and current polarities must be changed appropriately. In most computer programs, the model parameter values are always considered to be positive, and the appropriate sign changes are implemented internally by the program. The collector characteristics of the first-level Ebers-Moll model are shown in Fig. 5 as they would appear on a curve tracer. (Note that, even for this model, there is an inherent saturation voltage, V_{CESAT} .) Although it is very simple in form and requires, at most, five parameters, the first-level Ebers-Moll model is quite accurate. It is useful, not only for a dc characterization of the bipolar transistor, but also for simulating an ideal transistor.

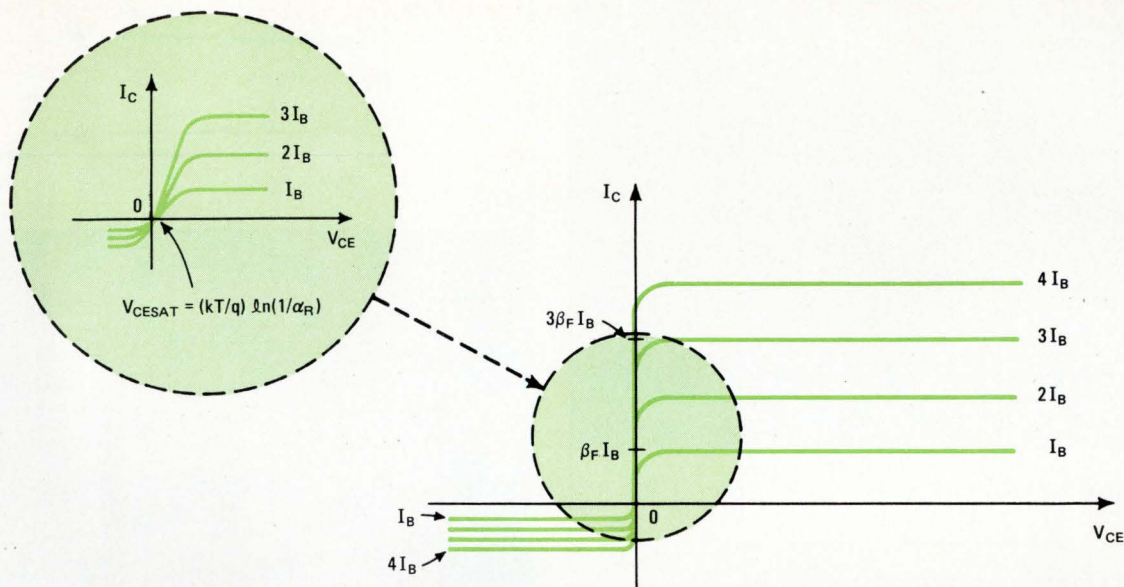

5. Collector characteristics. The first-level Ebers-Moll model simulates the behavior of an ideal bipolar transistor, as illustrated by these collector-characteristic curves. Such a model is generally useful for a dc characterization or when an ideal transistor is needed.

The principal limitation of the first-level Ebers-Moll model is its neglect of transistor-charge storage. It does not account for diffusion and junction capacitances, nor for ohmic resistances to the terminals. These model elements will be included in a first-order manner in the next article in this series.

Measuring the parameters

The test equipment for making terminal measurements of the parameters for the first-level Ebers-Moll model need not be highly sophisticated. Minimally, a curve tracer and a thermometer are all that are needed. If a curve tracer is not available, an alternate setup for measuring dc characteristics will be required.

The measurement schemes described here are by no means the only possible ones, nor are they necessarily the best ones. But they do work well, providing an acceptable accuracy for a computer simulation.

Parameter β_F is the ratio of the dc collector current to the dc base current when the transistor is in its normal active region, with its base-emitter junction forward-biased and its base-collector junction reverse-biased. Figure 6a shows how β_F typically varies with collector current, but for many applications, β_F can be assumed to be constant. A typical value of β_F may range from 5 for a high-current device to 100 for a small-signal device to 1,000 for a super-beta device.

The appropriate constant value of β_F can be determined from a curve-tracer display (Fig. 6b) of collector current versus collector-emitter voltage for a fixed base-current drive. β_F should be measured at the I_C and V_{CE} values at which the transistor will be operated. As already mentioned, the dc, rather than the ac, value

should be used. For example, the dc β_F would be:

$$\beta_{Fdc} = I_{C2}/I_{B2}$$

Whereas, the ac β_F would be:

$$\beta_{Fac} = \Delta I_C / (I_{B2} - I_{B1})$$

Parameter β_R , or the inverse beta, is the ratio of the dc emitter current to the dc base current when the transistor's collector-base junction is forward-biased and its emitter-base junction is reverse-biased. This parameter is also usually assumed to be constant; typically, its value is 0.1. The same technique is used to measure both β_F and β_R . However, to obtain β_R , the emitter and collector leads are interchanged. With some curve tracers, this interchange can be accomplished by simply rotating the transistor test fixture by 180°.

Evaluating saturation current

Parameter I_S is the saturation current that is related to the collector current and the base-emitter voltage, both of which can be readily measured. The collector current is defined by:

$$I_C = I_S [\exp(qV_{BE}/kT) - 1] - (I_S/\alpha_R) [\exp(qV_{BC}/kT) - 1]$$

When the transistor is in its normal active region, this expression reduces to:

$$I_C = I_S [\exp(qV_{BE}/kT) - 1]$$

I_S , which is directly proportional to the active emitter-base junction area, can vary significantly from device to device. A typical I_S value is 10^{-16} amperes.

To determine the value of I_S , a curve tracer can be used to display collector current versus collector-emitter

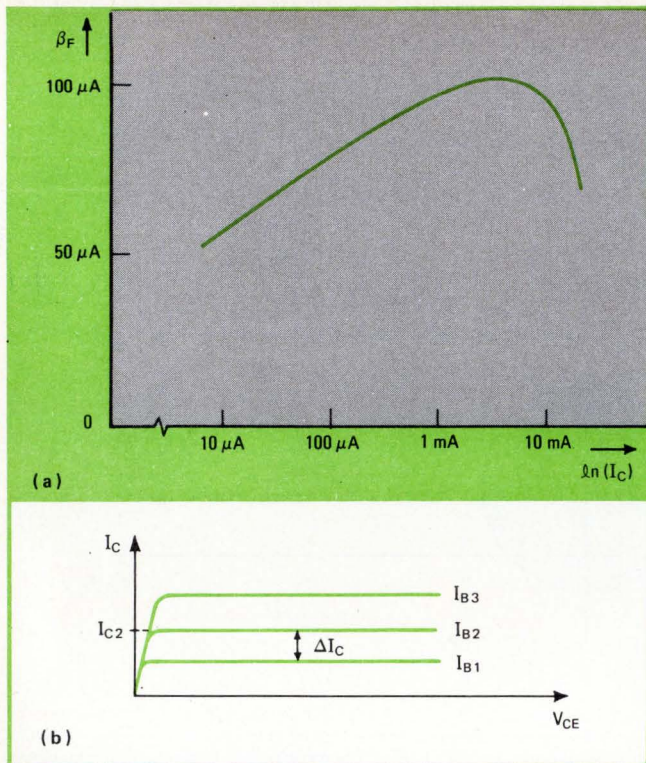

6. Determining the current gains. Parameters β_F (forward beta) and β_R (inverse beta) are two of the three parameters that must be measured to specify the first-level Ebers-Moll model. Although β_F typically varies with collector current, as shown in (a), it is assumed to be constant for this level of model complexity, as in β_R . The dc values of both betas can be obtained from the collector characteristics.

voltage at a constant base-emitter voltage, as shown in Fig. 7a. I_S can then be computed at a single V_{BE} value or found graphically from a plot of I_C versus V_{BE} . Because of the exponential dependence of I_C on V_{BE} , be careful never to set V_{BE} too large initially. Always start with small V_{BE} values, increasing to larger values—never vice versa.

Here's an example for a measurement of I_S for a single value of V_{BE} . Suppose the transistor's operating bias voltages are $V_{BE} = 591.5$ millivolts and $V_{CE} = 0.6$ v. Then, the value of I_S is the measured value of I_C (at these bias voltages) divided by 10^{10} , which is the value of $\exp(qV_{BE}/kT)$ here. Although this single-point measurement is simple and fast, it may not be accurate enough for many computer simulations.

A more precise method is to obtain I_S from a plot of I_C vs V_{BE} . A curve tracer can be used to display I_C as a function of V_{BE} directly, but greater accuracy can be obtained by actually drawing the curve from measured data points.

To do this, measure I_C at several points for $V_{BE} = V_{CE}$ so that $V_{BC} = 0$. Next, plot the natural logarithm (\ln) of I_C as a function of V_{BE} , as in Fig. 7b. The value of I_S is then obtained by extrapolating the curve to $V_{BE} = 0$.

At high current levels, the plot of $\ln(I_C)$ versus V_{BE} deviates from a straight line because of high-level injection and/or the effects of ohmic resistance. High-level injection occurs when the concentration of minority car-

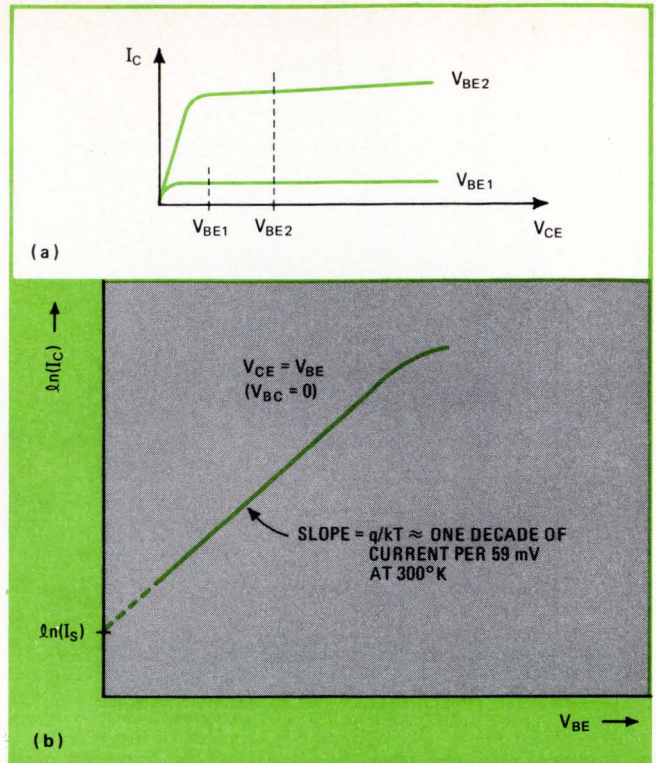

7. Determining saturation current. Parameter I_S (saturation current) is the third parameter that must be measured. It is a constant that can be computed from a single-point measurement of I_C at a constant V_{BE} value of $V_{BE} = V_{CE}$ so that $V_{BC} = 0$. The curve-tracer display of (a) shows I_C versus V_{CE} for a fixed V_{BE} . The value of I_S can also be extrapolated from a plot (b) of $\ln(I_C)$ versus V_{BE} .

riers in the base region, which are injected from the emitter, becomes comparable to majority-carrier concentration. Both high-level injection effects and ohmic-resistance effects can be accounted for with a more complex model than the first-level Ebers-Moll model.⁴

Parameter T_{nom} is the temperature at which all the other model parameters are obtained. It is typically taken to be room temperature, approximately 27°C or 300°K. The simplest technique for measuring T_{nom} is by means of a thermometer placed near the transistor. As long as the power dissipation of the device is low enough to increase junction temperature only negligibly, then the junction temperature is approximately equal to the room temperature. All the model parameters should be measured under low-power conditions at $V_{BC} = 0$. If thermal effects are important, a higher-order model should be used.

The energy gap, E_g , of the transistor's semiconductor material usually need not be measured. The appropriate E_g can be selected from a listing of typical values. For silicon, $E_g = 1.1$ eV; for germanium, $E_g = 0.67$ eV; and for a Schottky-barrier device, $E_g = 0.69$ eV. □

REFERENCES

1. P.E. Gray, D. DeWitt, A.R. Boothroyd, and J.F. Gibbons, "Physical Electronics and Circuit Models of Transistors," SEEC, Vol. 2, J. Wiley, 1964.
2. D.A. Hodges and D.O. Pederson, "The Here and Now of Computer-Aided Circuit Design," ISSCC Digest of Technical Papers, pp. 38-39, 1974.
3. J. Logan, "Characterization and Modeling for Statistical Design," Bell Systems Technical Journal, Vol. 50, pp. 1,105-1,147, 1971.
4. H.K. Gummel and H.C. Poon, "An Integral Charge Control Model of Bipolar Transistors," Bell Systems Technical Journal, Vol. 49, pp. 827-852, 1970.



EMR-Telemetry... in a class by itself.

Here, and in 20 other countries around the world.

When you're good at what you do, your reputation spreads world wide. But, excellence in system design and total product breadth isn't enough when you're selling turnkey systems.

It takes installation know-how, software expertise, customer training, and an attitude that says . . . we care now, and will care in the future about your changing needs.

EMR customers respond to this philosophy with enthusiasm. We don't just sell hardware . . . we're there when you need us, world wide. They know it at the National Space Agency in Japan, at the India Aeronautical Development Establishment, and at every key data gathering station around the globe.

Japan Space Program . . .

By 1976, the Japanese National Space Development Agency expects to launch a variety of communication and scientific satellites. EMR will supply both frequency and time division multiplex ground stations for use at several stages of the program: for experimenters to check out their scientific and communications packages; for functional tests of each stage of the rocket boosters; and for a complete checkout and monitoring system in the blockhouse at the launch site.

India Aircraft Flight Test Program . . .

The India Aeronautical Development Establishment is using an EMR ground telemetry Data Readout Station consisting of a quick-look, van-mounted, checkout system coupled with a large FM-PAM/PDM and PCM computerized telemetry system. Real-time flight testing of aircraft will be accomplished with this facility.

When can we help with your data gathering needs?

EMR EMR
Schlumberger

EMR Telemetry
Weston Instruments, Inc.
Box 3041, Sarasota, Florida 33578
813-371-0811

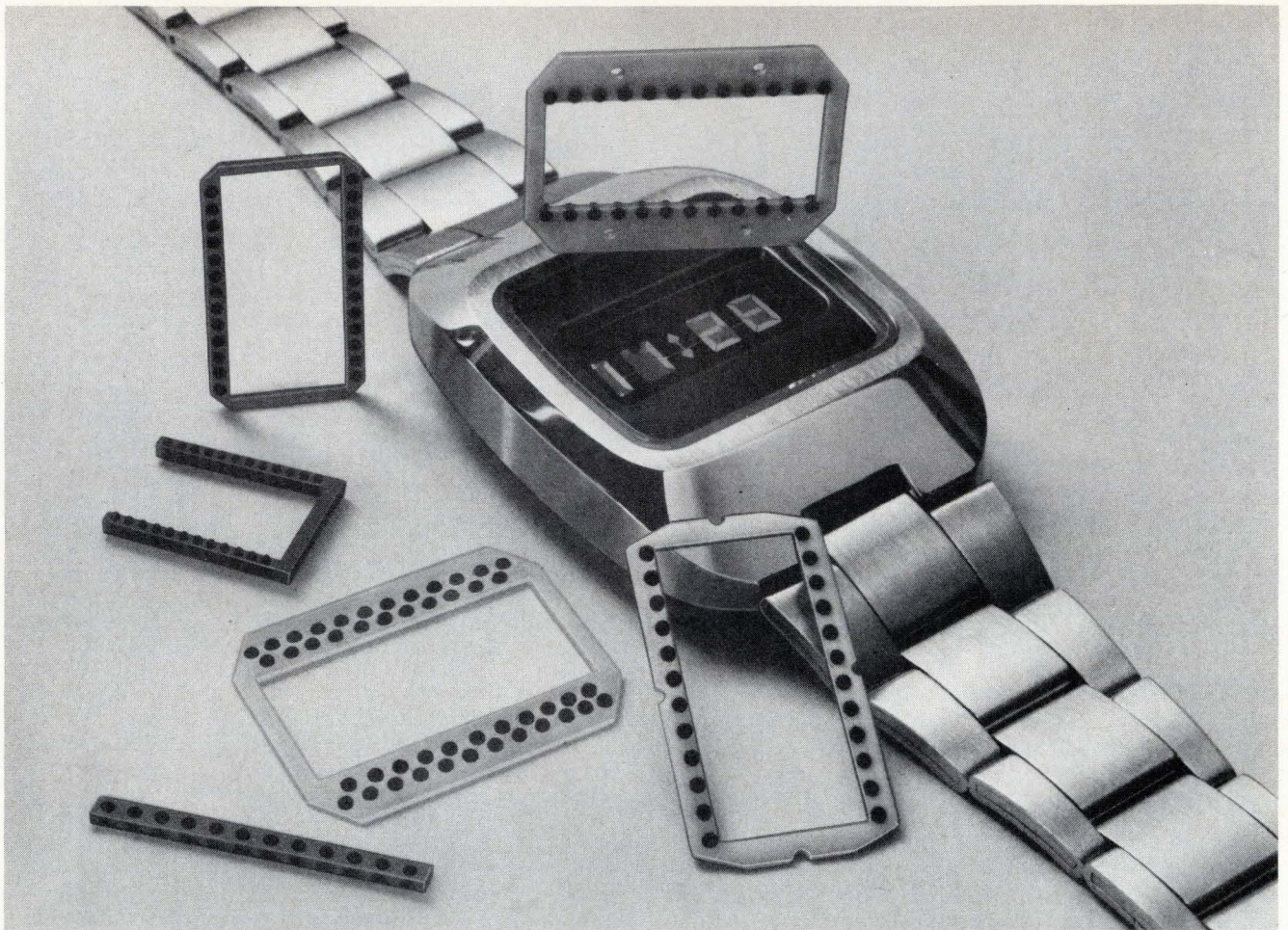

Conductive elastomers make small, flexible contacts

A wide variety of products—including liquid-crystal-display watches—can benefit from interconnections made with elastomers containing carbon or metal particles

by Leonard S. Buchoff, *Technical Wire Products Inc., Cranford, N.J.*

□ As solid-state devices grow ever smaller, the demand for smaller connectors with closer contact spacings grows larger. And when microelectronic circuitry has to be mated with displays in such increasingly popular applications as hand-held instruments, automobile dashboards, pocket calculators, and electronic watches, the need for connections with greater immunity to shock and vibration also grows.

Both sets of requirements are met by conductive elastomeric connectors, which have contacts formed from an elastomer such as silicone rubber that is made

conductive by the incorporation of carbon or metal particles. They cushion against shock and vibration, provide a gas-tight seal that excludes corrosive atmospherics, and are inexpensive in large quantities. The size, shape, conductivity and spacing of the contacts can be varied enormously, and they can be reproduced with great precision, yet still accommodate dimensional variations on the connected assemblies.

Such connectors are replacing other kinds of pressure contacts in applications such as zero-insertion-force, mother-daughter board, and liquid-crystal-display con-

nectors. Elastomeric buttons can be vulcanized onto almost any metal lead or wire, including printed-circuit boards, flat cable, and leadless IC packages (Fig. 1).

The most widely used elastomer is silicone rubber because of its resistance to most environments, including ozone, oxygen, ultraviolet light, water, and temperature extremes—its useful temperature range is typically -80°C to $+200^{\circ}\text{C}$. In addition, the material is easy to mold and exhibits low compression set.

Its highest strength and resistance to set is obtained when carbon is used as the conductive filler. Carbon filler is adequate if an electrical resistance of 100 to 5,000 ohms per connection is acceptable. Silver, silver-coated copper, or silver-coated glass spheres provide resistances per connection in the 0.1-to-10-ohm range, and nickel or other metals also can be used as conductive fillers. Other factors controlling contact resistance are fabrication technique and shape.

In fact, the way to produce the optimum combination of electrical resistance with mechanical force and deflection is to vary button shape—particularly height. Normally, buttons are designed to be compressed from 20% to 50% of their original height to allow for tolerance build-up on other components in the system. However, care must be taken not to make buttons too tall, or they may short out adjacent buttons or components when compressed or themselves flop over rather than compress.

Buttons through holes

In some applications, the circuitry on one side of a pc board or hybrid package has to make connection with elastomer buttons on the opposite side. Conductive rubber can be molded directly through the substrate, but only if the carrier has a thickness tolerance of ± 0.001 inch. Otherwise, flashing of the elastomer will occur around the transfer mold if the board is too thin, while too thick a board will suffer physical damage.

To circumvent the need to grind the board to the required dimension, conductive silicone rubber bumps can be molded to a solderable pin, which is then inserted through the pc board (Fig. 2). The silicone rubber provides a pressure contact on one side of the board, and the pin can be soldered on the other side.

Conductive elastomeric technology can also be used to mount components on a printed-circuit board if, for example, the board cannot be soldered. Figure 3 shows a printed-circuit board on which the circuit and resistors were silk-screened by using epoxy inks. Since soldering to the screened inks would not be feasible, attachment points for discrete components are provided instead by conductive elastomer buttons with holes molded through the center. In addition, since no soldering is involved, a thermoplastic board, which would be damaged by heat, can be used to provide the necessary ± 0.001 -in. tolerance.

The LCD connection

Liquid-crystal displays offer a major market for conductive elastomeric connectors. Metal contacts are unsatisfactory because they may have burrs and sharp corners that can damage the tin oxide or indium oxide

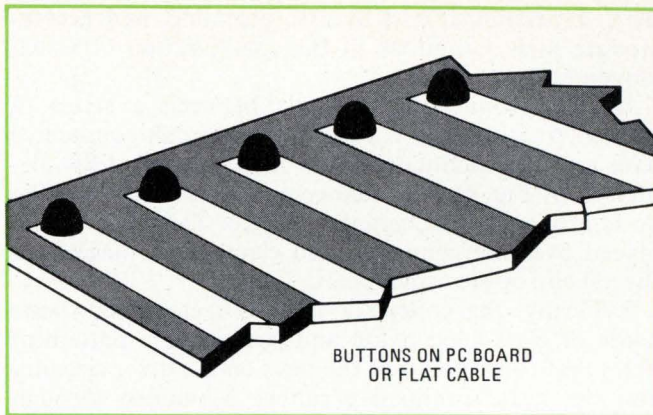

1. Rubber bumps. Conductive elastomeric connector contacts can be vulcanized onto almost any metal lead or wire.

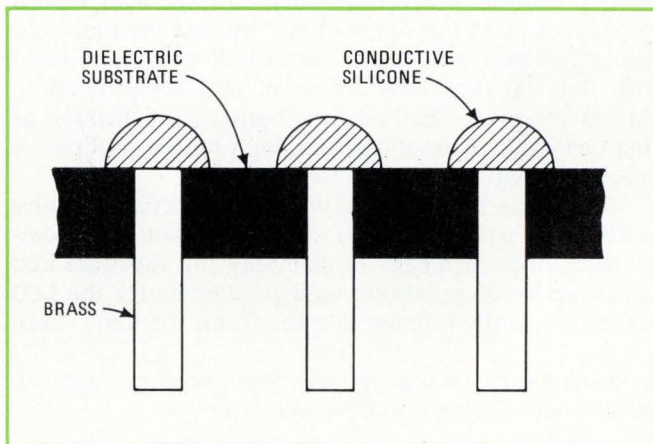

2. Through holes. Brass pins can be used to connect circuitry on one side of a board to elastomeric contacts on the other side.

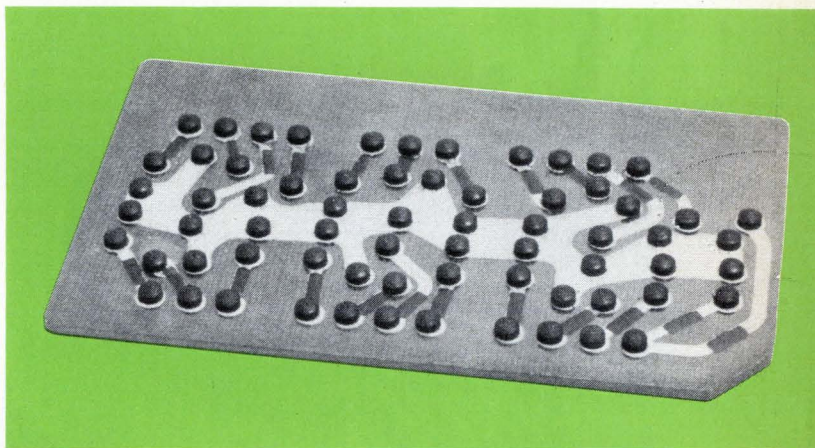

3. Solderless. Conductive elastomer buttons with holes molded through the center can be used for attaching discrete components where soldering isn't feasible.

conductive pads on the glass LCD package. They may also lose contact by being displaced after either shock or vibration.

The LCDs in most digital watches, for instance, are interfaced to the drive circuitry through elastomeric connectors. The requirements are stringent: connectors must be small, have close spacing—0.025 to 0.85 in.—between contacts, be replaceable in the field by inexpe-

rienced personnel, cost little to assemble, and accommodate wide variations in the configuration of watch movements.

Usually, connection is made between a series of printed-circuit-board pads or hybrid-circuit conductive pads and the conductive leads on two edges of the 3½-digit LCD (Fig. 4). The connector is positioned over the pc board or hybrid ceramic surface. The LCD is then placed over the connector and clamped in place by a special clip or the watch bezel.

Typically, the connector is a contact carrier frame made of glass-filled nylon and containing a pattern of holes that corresponds to the pads on the drive circuitry and the LCD. Conductive rubber is molded through these holes to form buttons that extend on each side of the carrier frame. In most watch applications, the conductive buttons are carbon-filled silicone with typical resistances of 200 to 5,000 ohms between the pads and the LCD. These values are very small when compared with the 200 megohms across an LCD segment. With carbon- or silver-filled silicone buttons, a deflection as small as 0.001 in. on a 0.015-in.-high button produces a reliable enough connection for LCD use.

The carrier frame can serve other functions besides holding or positioning the connective buttons. Compression stops, a means of clamping the substrate and LCD together as a subunit, and positioners for the LCD can be integrally molded into the frame. In some cases,

4. Watch the connection. The first major market for conductive elastomeric connectors is in LCD electronic watches.

5. Alternate. Elastomeric contacts can be molded directly on the watch-component carrier for space and assembly economies.

the carrier acts as a holder for the entire electronic circuit, including the quartz crystal, battery, and chip.

Some variations

The form and material of the carrier frame may be varied. Buttons can be molded into strips which are laid on each side of the LCD. Alternatively, if a minimum connector height is required, buttons can be molded through holes in a 0.002-in.-thick Kapton or Mylar sheet or strip to a total height of 0.008 in. This connector can then be positioned over the corresponding contacts of either the LCD or the pc board and be temporarily cemented in place as a subassembly.

An alternative to the button-in-frame connector scheme used in most watch designs is shown in Fig. 5. In this package, made by U.S. Electronic Services Corp., Sharon Hill, Pa., for Optel Inc., Princeton, N.J., metalized paths run from the chip-mounting pads on the underside of the connector to the top. On these exposed wire ends (shown at left in Fig. 5) are molded conductive rubber buttons (shown at right) that provide contact pads to the LCD. Careful preparation of the connec-

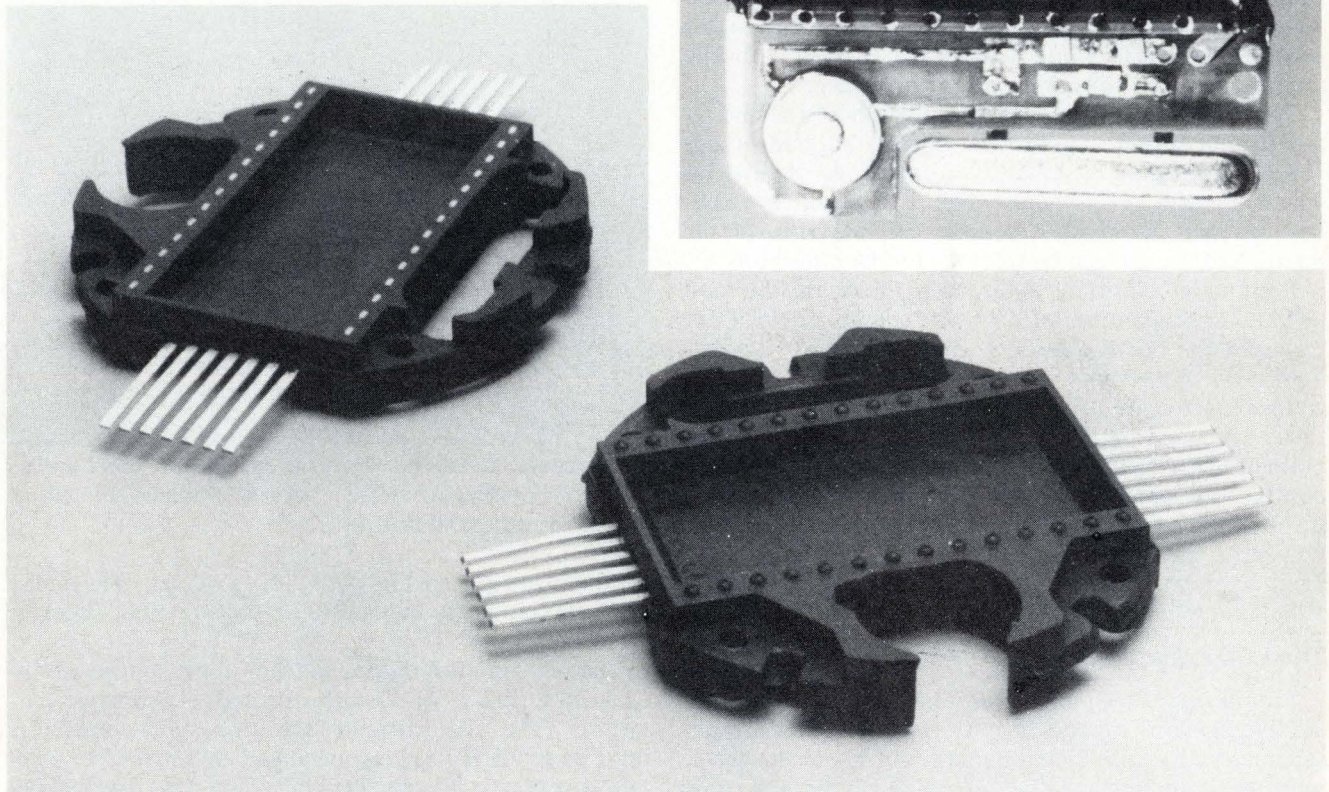
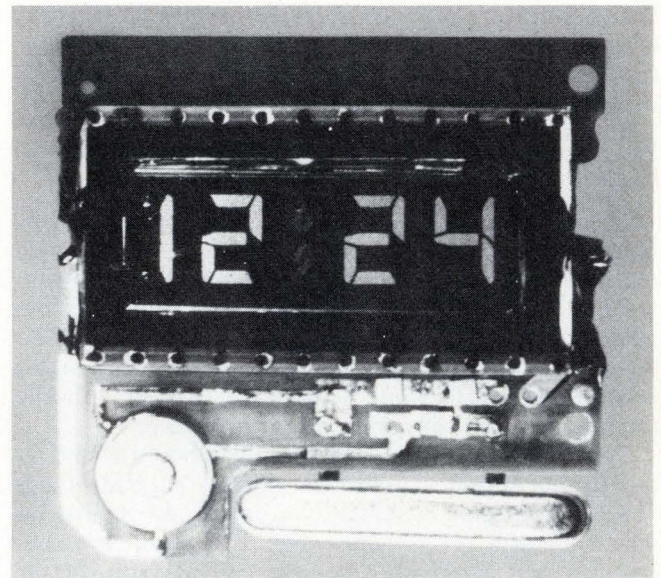

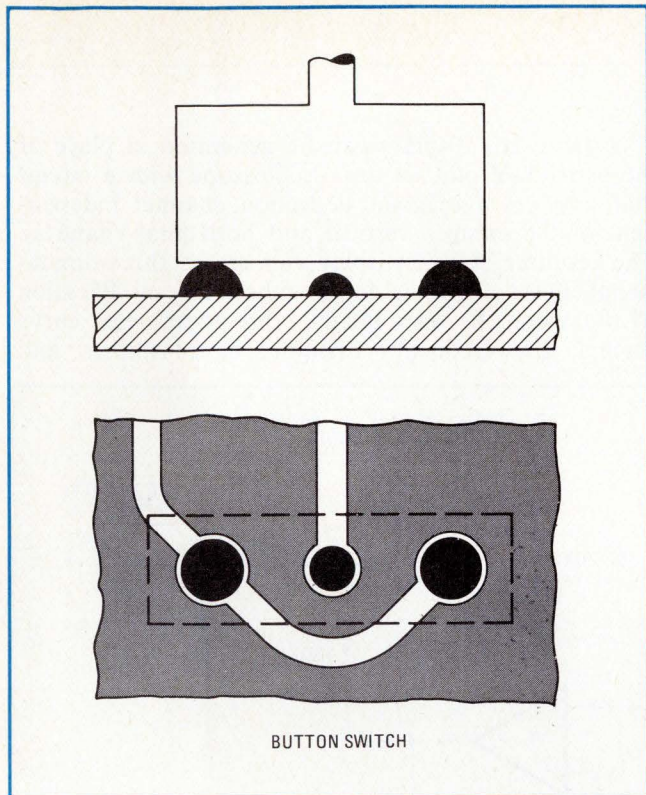

6. **A switch.** Conductive rubber bumps can serve as switch contacts and spring returns for the activator.

tor surface has produced excellent adhesion of the conductive silicone.

Connection to the liquid-crystal display is not the only area where conductive elastomers can be used in the electronic watch. Also under development or in production are: connections between the various circuit layers, connections to leadless IC chips, battery connections, grounding to the case, connection to the discrete resistors and capacitors, and connecting paths.

A rubber switch

The conductive-rubber bump switch shown in Fig. 6 is being designed into some electronic watches. Bumps are molded onto an interrupted path on a pc board. The higher bumps act as a spring return for the actuator, holding it in place. When the actuator is depressed, its conductive surface connects the lower bump to the other bumps, completing the circuit. As many as four different button heights can be produced in one group, and the entire array can be positioned in a circle as small as 0.15 in. in diameter. If the bumps are of various heights, continuing pressure on the actuator will create a sequence of discrete contacts, while bumps of different configurations will allow for quite distinctive tactile responses.

The advantage of having conductive rubber doing a number of jobs in a particular circuit is that the buttons can be produced in a single molding operation, greatly reducing the cost per connection. With proper design, only a minimum of space need be taken up by connectors and circuitry.

So far, digital watches have been the focus of discus-

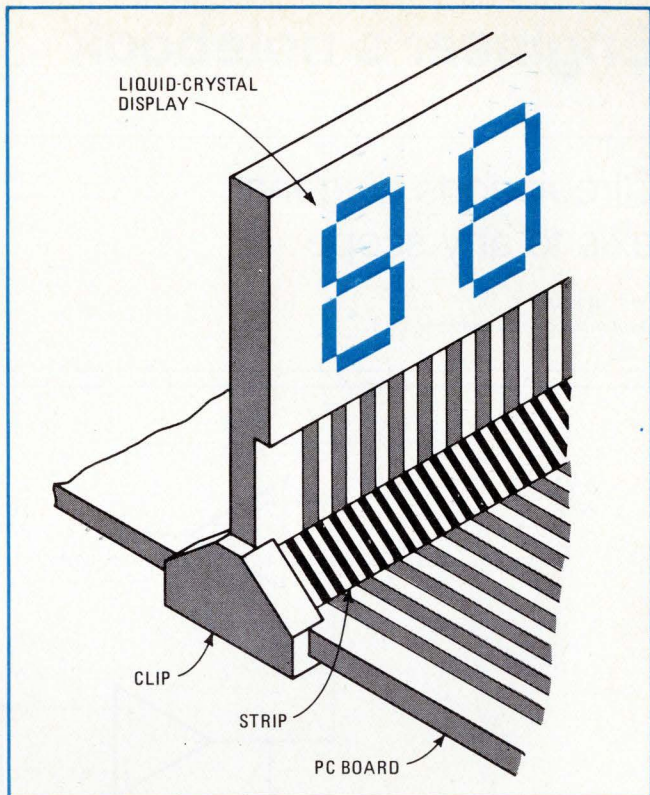

7. **Striped Interface.** Alternate layers of conductive and nonconductive silicone rubber can be used to form a connector.

sion. But elastomeric connectors can also be used with larger LCD units and pc boards. For this purpose, a connector concept about to be trademarked "Zebra" is useful. It consists of alternate layers of conductive and nonconductive silicone rubber (Fig 7). These are typically 10 mils wide each and carbon-filled in the case of the conductive layers.

For most of the present units, this spacing is acceptable—that is, where the center-to-center distance between pads is 0.040 in. or more and pad width is at least 0.015 in. But prototype connector strips have been supplied with layers as thin as 0.002 in. and silver-filled conductive paths. In use, there is always at least one conductive path joining every pair of matching contact pads, and there is always at least one insulating area between each set of pads.

Interfacing printed-circuit boards

To interface a printed-circuit board with a large LCD or a daughter board perpendicular to the pc board, the Zebra connector is supplied in triangular shape. It can be put across two butted pc boards to connect the corresponding paths or can be clamped between two pc boards to establish a removable connection. Other shapes can be cut to meet individual requirements.

As for other applications, conductive elastomers provide rapid, reliable connections in test fixtures and burn-in fixtures. They are inexpensive and readily adaptable to complex, multipoint contacts. The goal of continuing development programs is to produce conductive elastomer connectors for use with IC chips having conductive pads on 0.010-in. centers. □

Circuit adds diagonal axis to any scope

by Kai Lanz
Stanford University, Stanford, Calif.

True three-axis displays can be generated in place of the usual X-Y plot on any oscilloscope with a circuit that provides a diagonal-deflection channel independent of the existing vertical and horizontal channels. The resulting X-Y-Z display can create three-dimensional effects of striking depth without any modification to the scope. Its uses include three-parameter curve tracing, three-frequency Lissajous figure studies, and

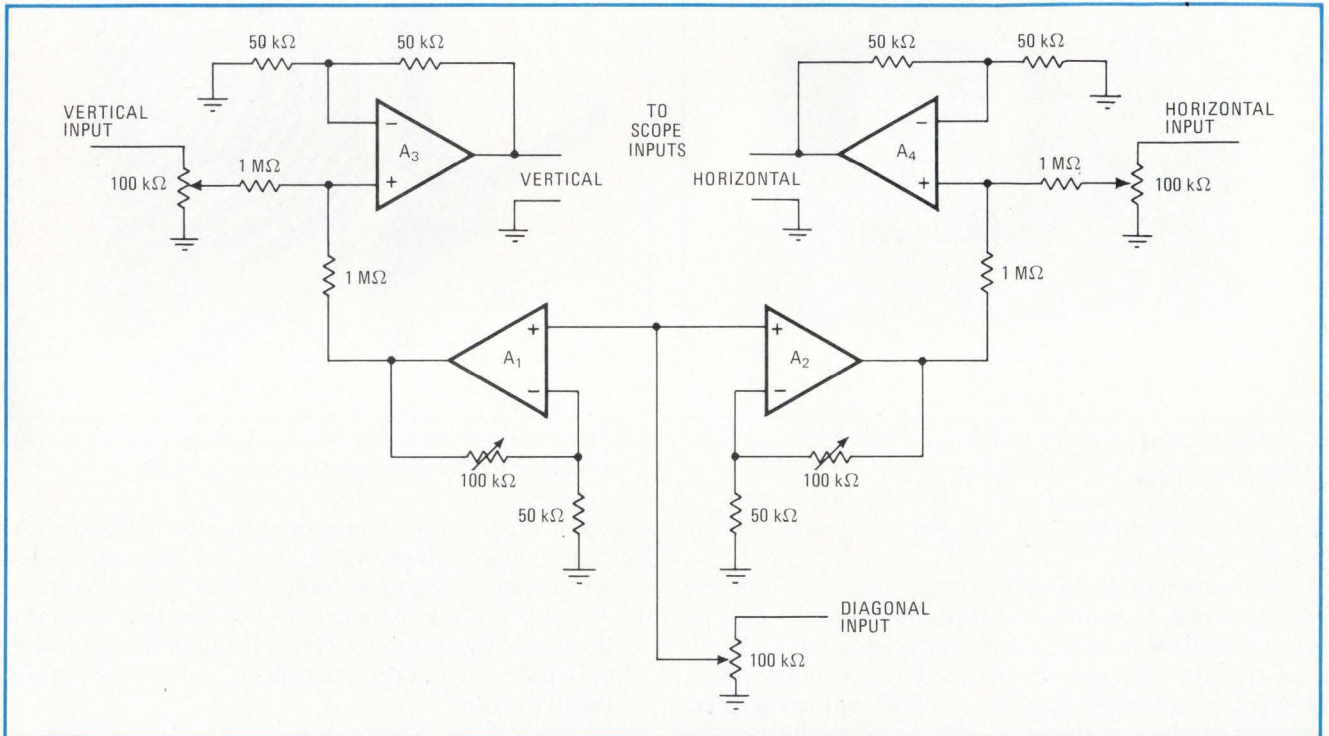

3-d circuit. Four operational amplifiers generate diagonal deflection to create illusion of depth on ordinary scope screen. Two op amps isolate the diagonal and the conventional inputs, and two more add these components to control the deflection.

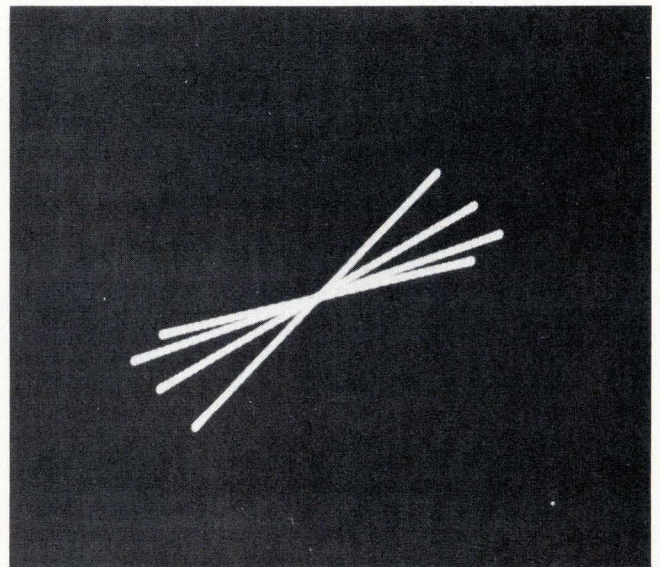
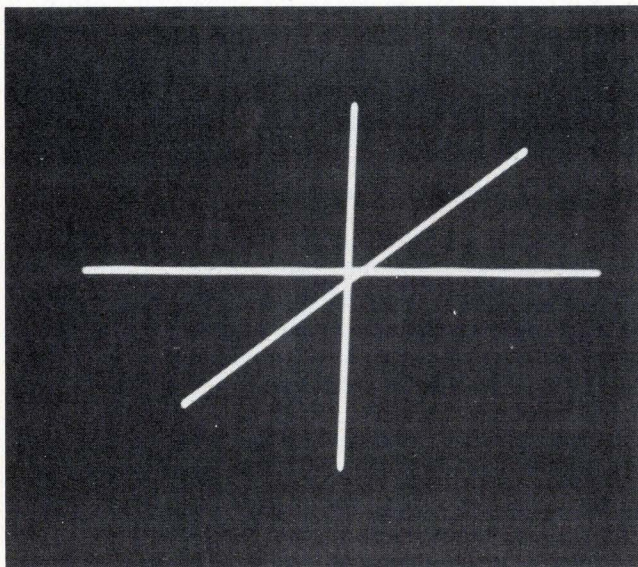

Three axes, various perspectives. Triple exposure (left) shows the three deflection axes, vertical, horizontal, and diagonal. Multiple exposure (right) shows different angles of perspective, obtained by varying the ratio of the gains of the isolating amplifiers.

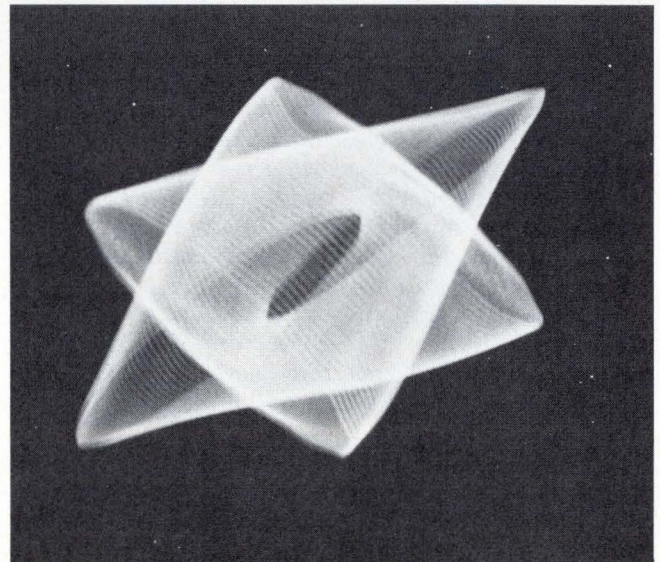
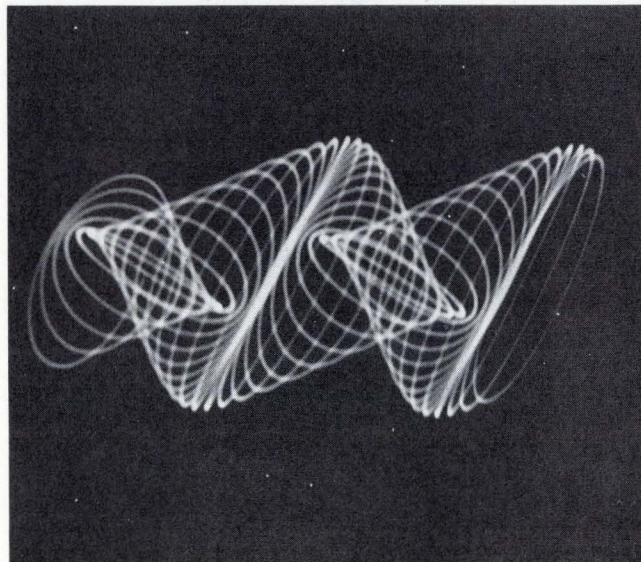
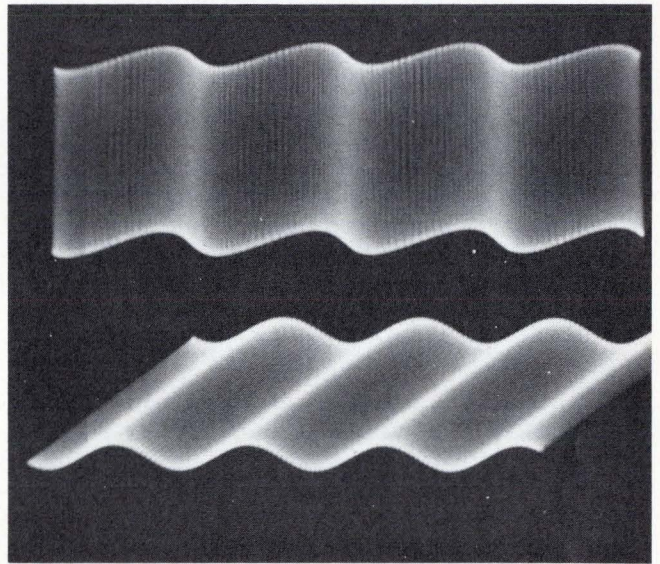
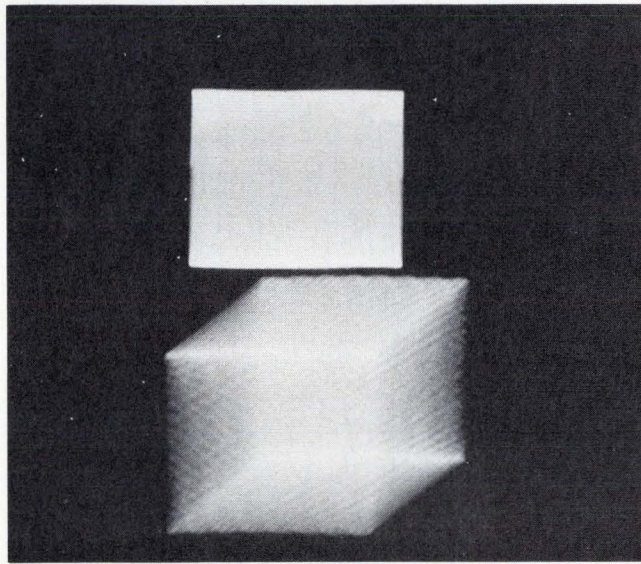
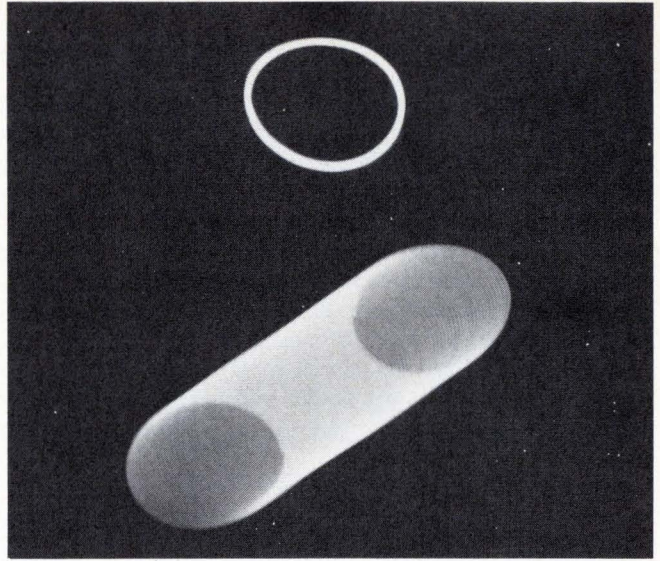
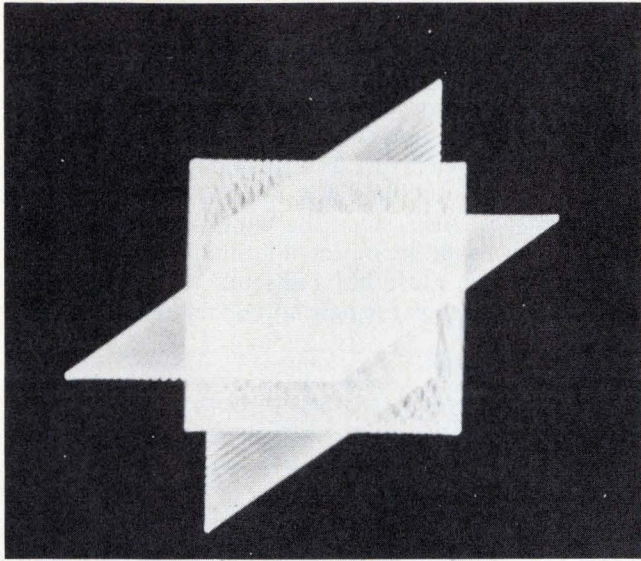

3-d displays. Triple exposure (top left) illustrates three deflection planes, X-Y, Y-Z, and X-Z. At top right is a 2-d Lissajous circle, also shown expanded into a cylinder. A square raster expanded diagonally into a cube is at center left. Two sine waves expanded vertically create wavy surfaces in X-Z and X-Y planes, respectively. At the bottom are two complex shapes produced from Lissajous figures.

three-dimensional character generation—to say nothing of many eye-catching and fascinating visual displays of all sorts.

For diagonal deflection, the diagonal input signal is applied simultaneously to both the vertical and horizontal amplifier inputs. This produces the familiar in-phase Lissajous pattern, a simple 45° line. Operational amplifiers A₁ and A₂ isolate the diagonal input from the vertical and horizontal inputs, while A₃ and A₄ add the diagonal signal components and the vertical and horizontal inputs respectively. The gains through A₁ and A₂ are adjustable, to vary the angle of the diagonal axis, which is proportional to the ratio of these gains. Adjustments on the three inputs provide noninteractive con-

trol of the sensitivities of the three channels.

The four op amps should be identical and identically compensated, especially for work at high frequencies. Otherwise, for example, if the phase-shifts through the two legs of the diagonal channel are not equal, the diagonal deflection line expands into an ellipse. Obviously a quad op amp is the best way to obtain these identical characteristics. Also, since the circuit uses the scope's external horizontal input, the internal horizontal sweep, if it is desired, must be connected from the scope's sweep-output jack to the new horizontal input. □

Engineer's Notebook is a regular feature in Electronics. We invite readers to submit original design shortcuts, calculation aids, measurement and test techniques, and other ideas for saving engineering time or cost. We'll pay \$50 for each item published.

Self-powered comparator warns when signal exceeds limits

by Roger Fell
Analog Devices Inc., Norwood, Mass.

An analog comparator circuit that indicates whether the signal measured by a digital panel meter is within programmable limits is powered entirely by that same DPM. The circuit is particularly useful for system applications in which the voltages of process-control equipment or pollution have to be monitored.

The DPM displays all input signals, regardless of the limits, but flashes the polarity sign or digital display for inputs outside the desired range. The comparator works with any DPM that has blanking circuitry for the polarity sign or entire display; the Analog Devices AD2006 is suggested because it has, in addition to the blanking circuitry, ±15-volt dc and +5-v dc outputs that supply sufficient power for the comparator circuitry.

The reference output of the DPM is used here as a stable reference voltage for the comparator. It is buffered and attenuated by operational amplifiers A₁ and A₂ to levels of ±2.5 v. Potentiometer R₁ is set for the lower threshold and R₂ for the upper threshold, both at any value within the DPM's input range.

An analog input between the two thresholds drives the outputs of op amps A₃ and A₄ positive. The diode network at the outputs of A₃ and A₄ is a primitive AND gate, which turns on transistor Q₁ if both op-amp outputs are high. This short-circuits the timing capacitor C₁ of the NE555 timer, which is connected as an astable multivibrator. With pin 6 of the timer held at digital ground, the output of the timer at pin 3 is forced high. This signal, at the blanking input of the DPM, unblanks the polarity sign or display.

When the analog input signal of the DPM is above or below the preset thresholds, one of the two op-amp outputs is driven negative, turning off transistor Q₁, and removing the short circuit across C₁. This enables the astable multivibrator to operate; the resulting square wave at its output flashes the polarity readout of the DPM at a rate of about 5 hertz. □

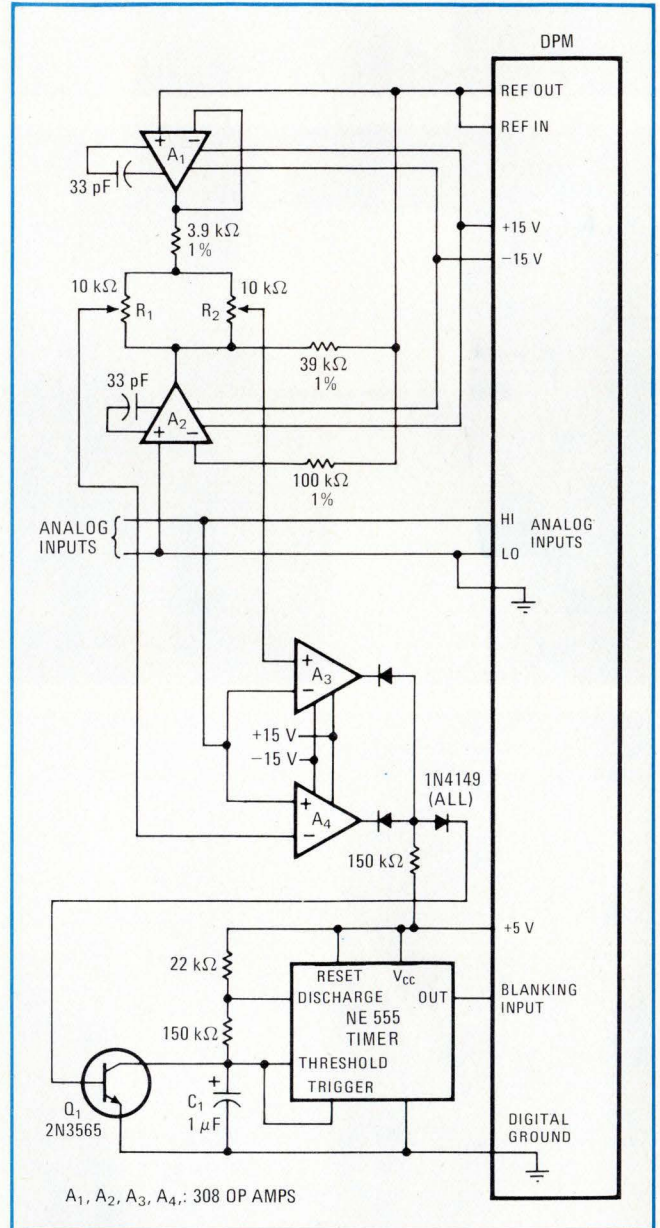

Limit checker. Potentiometers define upper and lower thresholds for permissible range of analog signal. When input is above or below the threshold range, the timer, connected as an astable multivibrator, begins to flash either the entire display or its polarity sign.

16Kx18 =

more core in Fabri-Tek's reliable 600 Series

We have an addition to our 600 Series! It's the Model 686 Core Memory System with a basic module capacity of 16K x 18. Like all 600 Series models, the 686 combines off-the-shelf availability with reliable performance and minimum cost.

Modular constructed, ferrite core memories permit operation of up to eight modules in a single enclosure. Developed for a wide variety of data storage applications, the entire 600 Series is completely compatible with TTL logic. So, check the specifications, then specify the 600 Model that best fits your application.

The 620 Core Memory System

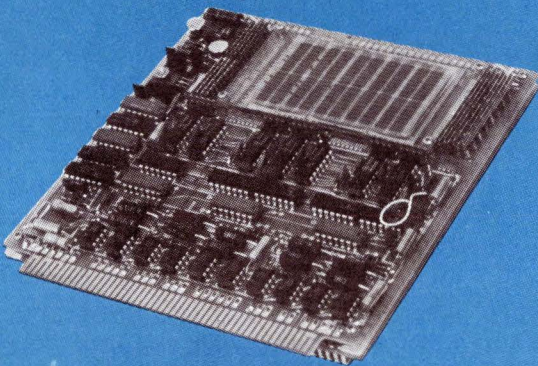

Capacity of 1,024 words by 10 bits on a single card. Planar 3-D, 4-wire configuration measures 6.0 x 6.4 inches. Expandable. Access time: 350 nanoseconds. Full cycle time: 1.0 usec.

The 684 Core Memory System

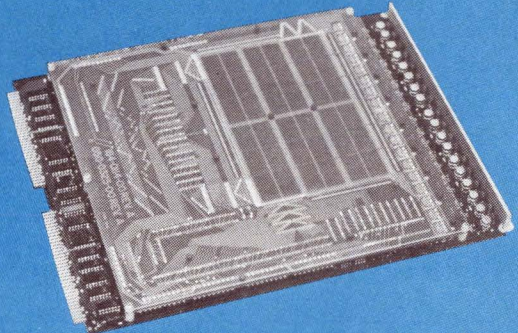

Basic module capacity of 8,192 words by 18 bits on a single card. Expandable to 32K x 36, 64K x 18 or 128K x 9 bits. Planar 3-D, 3-wire configuration measures 11.0 x 14.75 inches. Access time: 300 nanoseconds. Full cycle time: 650 nanoseconds. System options include: enclosures with printed circuit back panels, power supplies and test exerciser, and 250 nanosecond access time option.

The 686 Core Memory System

NEW

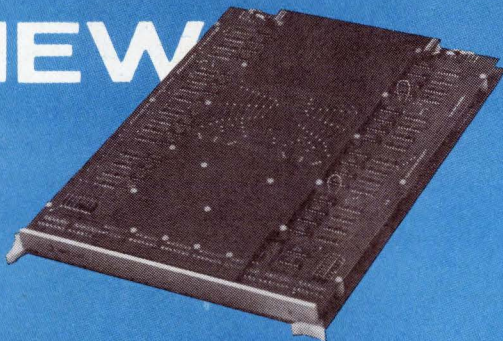

Basic module capacity of 16,384 words by 18 bits on a single card. Expandable to 64K x 36, 128K x 18 or 256K x 9 bits. Planar 3-D, 3-wire configuration measures 11.625 x 20.0 inches. Access time: 350 nanoseconds. Full cycle time: 750 nanoseconds. System options include: enclosures with printed circuit back panels, power supplies and test exerciser.

The 688 Core Memory System

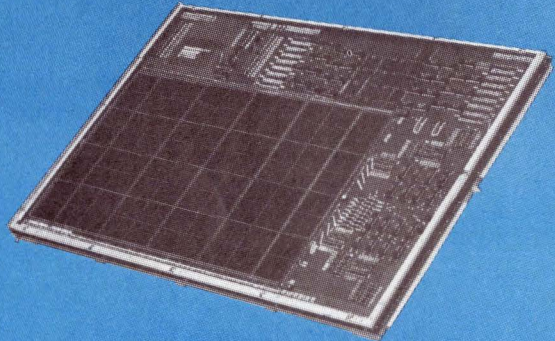

Basic module capacity of 32,768 words by 20 bits on a single card. Expandable to 128K x 40, 256K x 20, or 512K x 10 bits. Planar 3-D, 3-wire configuration measures 15 x 21.5 inches. Access time: 500 nanoseconds. Full cycle time: 1.2 microseconds. System options include: enclosures with printed circuit back panels, power supplies and test exerciser.



FABRI-TEK INC. COMPUTER SYSTEMS

5901 South County Road 18 • Minneapolis, MN 55436 • (612) 935-8811
Leader in Memory Technology for Over a Decade

SALES OFFICES IN:

Boston (617) 969-5077	Dallas (214) 661-3155	Detroit (313) 487-5940	New Jersey (201) 964-4770	Phoenix (602) 266-4448	Hong Kong K-331383	Tokyo (03) 432-6901
Chicago (312) 437-4116	Denver (303) 753-0631	Long Beach (213) 420-2493	Orlando (305) 857-1050	Sunnyvale (408) 739-4780	Munich 089-755-8298	United Kingdom Maidenhead 37321-4

Potentiometer OK with FET setup to keep linearity

When a single field-effect transistor is used as a voltage- or current-controlled resistor, its resistance characteristic unfortunately becomes highly nonlinear at high signal levels, notes D. S. Gibbs, an applications engineer at Ferranti Ltd., Oldham, England. But, by using two FETs—either p-type or n-type devices, one inverted and the other noninverted—you can cancel out the nonlinearity of each FET and obtain an extremely linear resistance characteristic.

It's done with a potentiometer. The input control signal is applied to the wiper of the potentiometer whose resistance element is connected between the source of one FET and the drain of the other. The gate of the first is then grounded, as is the source of the second. Then the drain of the first and the gate of the second are tied together, with the output taken between these two terminals. The potentiometer can now be used to balance the two FETs so that signal distortion can be minimized.

Scanner provides visual display for coordinates

IC design specialists fed up with painstaking mechanical processes for finding precise X, Y, and Z coordinates of a sample under test should check out a scanning sample positioner—a \$2,000 instrument from Varian's Vacuum Division, Palo Alto, Calif., that provides a visual display on a monitor to guide you to the spot on the chip you want to analyze. The image of the chip's surface is precisely defined by an electron beam from an auger gun, making indirect readings of the sample position unnecessary. When ready for the analysis, the scanner is switched out of the circuit, removing both the scan voltages from the gun and the bias from the sample.

Small thermometer offers designers circuit access

To troubleshoot those temperature-related circuit problems, designers might consider a pocket-sized thermometer that's available with fast-response surface temperature probes able to poke into hard-to-reach device points on a breadboard. Just touch the probe tip to the surface to be measured for a quick $\pm 1\%$ -accuracy meter readout—from -110°F to $+750^\circ\text{F}$. Two probe types are available: a stainless steel shaft with a 90° angle for junctions and nodes, and a large flat tip with a straight shaft for conductors. From Heat-Prober Div., William Wahl Corp., 12908 Panama St., Los Angeles, Calif. 90066.

555-type timer used to shape square waves

For a low-cost square-wave shaper, try the 555-type IC timer—a suggestion from Joe R. Wild, a product engineer for the B.F. Goodrich Co. in Akron, Ohio. This device's comparator characteristics make it a fast-switching wave shaper ideal for optical circuits, or when you want to use the ac line frequency as a clock reference. Any positive waveform can be squared up.

Wiring the timer is easy. The signal to be squared is applied to the timer's threshold and trigger pins, which are tied together. The reset and V_{CC} pins are also tied together and then run to the supply voltage. The ground and output pins are the standard types. (Discharge and control-voltage pins are not used.)

—Laurence Altman

Ask The Man Who Uses One

He works for these
companies:

Fairchild
Hamilton Standard
ITT Avionics
ITT-Europe
NCR
Rank Xerox
Raytheon
RCA
Siemens
Sperry
Sycor
U.S. Air Force
U.S. Navy
Western Electric
Xerox

He knows the real value of flexibility and economy in computer-controlled test systems. He needs a system that is truly interactive, easy to program, capable of conducting any type of functional or dynamic testing, able to handle any kind of digital, analog, and HF unit under test, and ready for today's — and tomorrow's — complex test requirements.

With the IE System 390, the software is the key. User-oriented software, with an English-language test program, makes it easy to conduct tests and fault isolate down to a component level on a variety of test units, with minimal hardware changes.

Send us your test requirements, and we'll show you how the System 390 can meet all of them efficiently and economically. We'll also send you our User Catalog.

Contact:

Instrumentation Engineering, Inc.,
769 Susquehanna Avenue,
Franklin Lakes, N.J. 07417;
telephone: 201-891-9300.

Instrumentation
Engineering 

The System 390

Ask The Man Who Uses One.

Los Angeles Office:
213-884-8241

Washington, D.C., Office:
703-451-1422

Europe Offices:
Siemens AG
D 7500 Karlsruhe 21
595-2591
D 8000 Munich
7200-7131

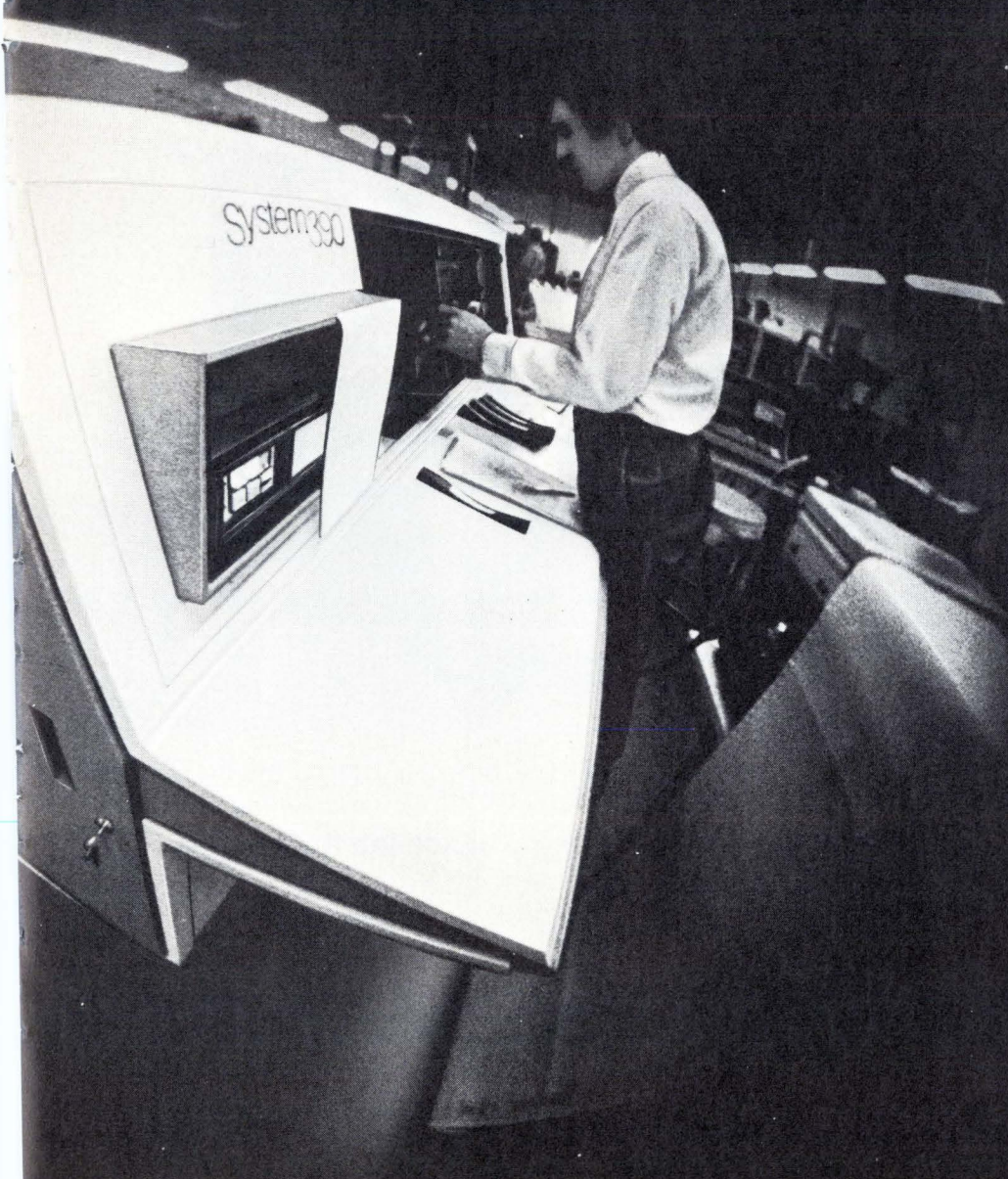

Proven Performance.

Computer:	General Automation SPC-12/20. Step and repeat, mirror image, automatic rewind. Handles variety of formats.
Spindle feed rate:	20-250 ipm. Accuracy to within 2% of setting. Stroke limit adjustable, 0.001-in. increments.
Table travel speed:	400 ipm each axis. Computer-driven, high-torque, high-speed, low-inertia servo motor gives instant acceleration.
Drill hit rate:	200/min. Quality holes on 1/4-in. movement with 3-high stacks and 0.002 chip load.
Spindle motor speed:	15,000-45,000 rpm electric motors; 15,000-60,000 rpm liquid-cooled, frequency-controlled motors; 30,000-80,000 rpm air-bearing frequency-controlled motors.

The Excellon Mark III. Nobody's equalled it yet.



The Excellon Mark III is the most advanced p.c. drilling system in the industry today.

We've had more than our share of advances over the years. The fact is, when we added up the knowledge we've gained from our successes (and failures), we had all the makings of a major breakthrough.

The magnificent Mark III, for instance.

World-wide, the Excellon Mark III is giving unequalled performance with highest production rates possible . . . at the lowest hole costs possible, with high accuracy and clean, smear-free holes.

It has no competition because nobody's equalled it yet. Call or write Dick Hogan, Sales Manager. His number is (213) 325-8000.

Excellon Automation

A Division of Excellon Industries
23915 Garnier Street
Torrance, California 90509
Phone: (213) 325-8000

Telex: 67.45.62 Cable: Excellon Torrance



Excellon Sales and Service in ENGLAND • FRANCE
SCANDINAVIA • W. GERMANY • HOLLAND • AUS-
TRALIA • HONG KONG • TAIWAN • JAPAN

New products

IC op amp has C-MOS output

Device also includes interdigitated p-MOS input structure and bipolar gain stages; process mix offers benefits in gain, speed, and voltage swing

by Laurence Altman, Solid State Editor

Both the designer and the user of linear circuits can enjoy the benefits accruing from the new-found ability of processing specialists to add MOS stages to these circuits. With MOS, the designer can now overcome some basic shortcomings of bipolar technology—such as high current inputs and low impedance outputs—and in the process simplify his design while improving performance.

That is exactly what RCA Corp. has done for a new operational amplifier that has a p-MOS input structure, bipolar gain stages, and a C-MOS output structure. It's the first time that a C-MOS output stage has been designed into a monolithic op amp.

An example of a product that lends itself to the combined C-MOS and bipolar process is the automobile seat-belt interlock. Today's systems use either all C-MOS or all bipolar technology. Here comparators are required, along with the necessary logic to ensure that the driver and passengers have their seat belts fastened under many complex conditions. The output of the circuit usually requires handling more than 100 milliamperes for driving a relay, a solenoid, and/or a lamp. The comparator and logic functions are easily implemented by C-MOS logic, while the current-driver function is more easily suited to bipolar technology.

The new process is also expected to have an impact on devices in computer-interface equipment. These include clock drivers, level shifters, and sense amplifiers for semiconductor memories, as well as drivers and receivers for data communications.

The advantages in performance from these mixed processes is shown in the table on page 135. Because interdigitated p-MOS transistors are used in the input stage of the CA3130, typical input-offset voltages of 2 millivolts and an offset-voltage temperature-tracking characteristic of 5 microvolts/°C are obtained. The input has an open-loop differential input impedance of 1,000 megohms, input bias current of a mere 5 picoamperes, and the ability to swing below the negative supply-voltage rail by about 1 V.

Most of the voltage gain is achieved in the second stage, a bipolar-MOS design. An npn transistor

drives cascoded p-MOS devices. The high output resistance of the p-MOS cascode configuration and C-MOS output inverter results in a voltage gain of 6,000. This minimizes the size requirement of the compensation capacitor and maximizes speed.

Unique is the output stage—a C-MOS inverter that is capable of providing a voltage swing within a few millivolts of the positive and negative rails. The CA3130 can sink or source a minimum of 20 milliamperes, and, since the gate of the output inverter is available, that current-handling capability can be increased by connecting additional C-MOS inverters—from a CA3600,

Path of gain. In CA3130's second stage, a bipolar-MOS design, high output resistance of p-MOS cascode configuration and C-MOS output inverter give voltage gain of 6000.

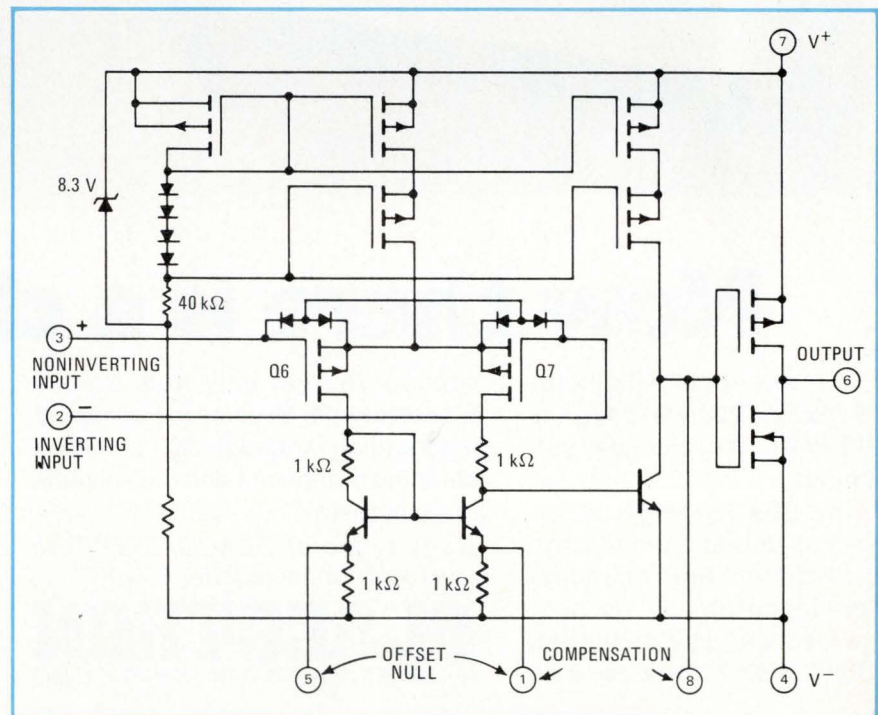



Now there is a choice.

DuPont calls their trichlorotrifluoroethane "FREON" TF. We call ours "BLACO-TRON" TF. So now you have a choice.

That's why BLACO-TRON precision cleaning solvent cleans the same as FREON: Their chemical formulas are identical.

If they're identical, why should you try BLACO-TRON? Service. The

service you get only from Baron-Blakeslee—for 38 years the accepted leader in advanced design precision cleaning equipment and the solvents to go in them.

Many types of BLACO-TRON are available for immediate delivery.

BLACO-TRON
FLUORINATED SOLVENTS—NOW THERE IS A CHOICE

NEW

**Precision
Cleaning
Solvent**

REFERENCE GUIDE

Covers the full line of BLACO-TRON fluorinated solvents—with complete specifications on each solvent.

WRITE FOR YOUR COPY TODAY.



Baron-Blakeslee

1620 South Laramie Ave., Chicago, Ill. 60650—Offices in All Principal Cities.

*FREON is DuPont's registered trademark for its fluorocarbon cleaning agents.

**BLACO-TRON is Baron-Blakeslee's registered trademark for its fluorocarbon cleaning agents.

Circle 134 on reader service card



**Call your nearest
Baron-Blakeslee "BLACO"
SERVICE CENTER
for prompt Solvent Service**

- New England**
General Chemical Corp., Boston, Mass.
(617) 872-1202
The Hubbard-Hall Chemical Co.
Waterbury, Connecticut
(203) 756-5521
- Metro New York City, Northern New Jersey,
Long Island**
Baron-Blakeslee, Garden City, N.Y.
(212) LE9-8680
(201) 687-7383
(516) 747-8460
- South New Jersey, Eastern Pennsylvania,
Maryland, Delaware**
Tri-State Chemicals, Inc.
Blackwood, N.J. (Philadelphia)
(215) LO3-5071
- Southeastern United States**
MORELAND CHEMICAL CO. INC.
Spartanburg, S.C.
(803) 583-8481
Greenville, S.C.
(803) 242-3727
Florence, S.C.
(803) 662-5246
Augusta, Ga.
(404) 722-3751
Atlanta, Ga.
(404) 457-4485
Kingsport, Tenn.
(615) 247-7149
Chattanooga, Tenn.
(615) 894-8700
Charlotte, N.C.
(704) 392-4301
Greensboro, N.C.
(919) 292-0624
Tampa, Fla.
(813) 685-5874
- Upstate New York, Northwest Pennsylvania**
Inland Chemical Corp., Syracuse, N.Y.
(800) 348-4661
- Indiana, Ohio, Michigan**
Inland Chemical Corp.
Ft. Wayne, Indiana
(800) 552-4605
Inland Chemical Corp., Toledo, Ohio
(800) 348-3621
Inland Chemical Corp.
South Bend, Indiana
(800) 552-4605
Inland Chemical Corp., Cleveland, Ohio
(800) 348-3621
Inland Chemical Corp., Lima, Ohio
(800) 348-3621
- Illinois, Wisconsin, Minnesota, Iowa,
Missouri, Nebraska**
Baron-Blakeslee, Chicago, Illinois
(312) 656-7300
Baron-Blakeslee, Milwaukee, Wisc.
(414) 762-6850
- No. California, Nevada**
Baron-Blakeslee, San Francisco, Calif.
(415) 591-8237
- Oregon, Washington**
Baron-Blakeslee, Portland, Oregon
(503) 252-3468
- Southern California, Arizona**
Baron-Blakeslee, Los Angeles, Calif.
(213) 532-0730
- San Diego Area**
Baron-Blakeslee, San Diego, Calif.
(714) 295-0041

New products

for example—in parallel with the output. The gate terminal may also be used for strobing the CA3130 to reduce a system's power dissipation.

The C-MOS output stage has one other distinct advantage over bipolar types—it has intrinsic short-circuit protection. Most bipolar circuits have active short-circuit protection, which affects the output characteristic of the device being protected. But the MOS output transistors of the CA3130 exhibit a short-circuit current that is limited, primarily by the transistor's gate-to-source voltage. And short-circuit current decreases with increasing temperature. The CA3130 output voltage is also

ative than 0.3 V, presenting the user with a difficult clamping problem in order to gain protection in a realistic system.

The C-MOS output enables a user to design threshold detectors in which the accuracy of the trip voltages strictly depends on the supply voltage and external feedback-resistor tolerances. This is possible because the output voltage is guaranteed to swing to within 10 microvolts of the positive and negative rail voltages. By comparison, 741 op amps display inaccuracies, not only because output voltages are temperature-dependent, but also because output voltages can only

TYPICAL PERFORMANCE CHARACTERISTICS

($V_+ = 15\text{ V}$, $T_A = 25^\circ\text{C}$)

Input-offset voltage	2 mV
Input-offset current	0.5 pA
Input-bias current	5 pA
Voltage gain (large signal)	100,000
Common-mode rejection	90 dB
CMR input-voltage range	0 – 11 V
Sink	20 mA
Maximum output-current source	22 mA
Maximum output voltage	10 mV to 14 V
$V_{10}/\Delta T$	5 $\mu\text{V}/^\circ\text{C}$
Unity-gain crossover	15 MHz
Slew rate (unity gain, noninverting)	8 V/ μs

independent of temperature. In contrast, the output characteristics of standard op amps, such as the 741, have output voltages that are a function of collector-emitter and base-emitter voltages, two temperature-sensitive parameters.

Because of its novel characteristics, the CA3130 can be used in a variety of applications. As a comparator, it can be operated from a single supply and, with a reference voltage, close to ground, even in a noisy environment, since its inputs can be driven below the negative rail. Most single-supply op amps available today cannot go more neg-

swing to within about 1 V of each supply rail. Other applications for the CA3130 include wide-range current-to-voltage converters, power supplies, and audio amplifiers.

Three versions of the new op amp are available. The CA3130, which is a commercial type, has an input offset voltage of 2 mV and is priced at 75 cents. The other two are high-reliability types: the CA3130A, which has offset voltage of 2 mV, is priced at \$2.95; and the CA3130B, priced at \$9.95, has an offset voltage of 0.8 mV.

RCA, Solid State Division, Route 202, Somerville, N.J. 08876 [338]

Components

Cherry moves into displays

Gas-discharge panels aimed at calculator, auto, instrument markets

In a diversification move that brings Cherry Electrical Products Corp. into the information display field for the first time, the Midwest components company has introduced at Wescon 74 a line of gas-discharge display panels.

The digital readouts, called the Plasma-Lux line, are being produced under a license from Burroughs Corp. They are similar to the Burroughs Panaplex displays and are interchangeable with them in application. Cherry officials say they have made changes in the design and the manufacturing process that affect contrast and the intensity of light in the seven-segment characters.

The panels now in production contain only numerical characters, but Cherry plans to start production soon on alphanumeric types. The basic panel has 13 digits, and the company is working on a version that will permit up to 16 positions. The neon orange color is easily filtered, the company points out, and the 0.40-inch-high digits are readable at 25 feet.

Thin- and thick-film technology are used in the manufacturing process, and one of the features of the Plasma-Lux line is a back light that fills the gaps between character segments and gives the appearance of more nearly continuous lines.

Other advantages, attributed by the company to advanced film technology and the manufacturing process, include high contrast, flicker-free brightness, uniform consistency among segments of the characters, low power consumption and long life.

The panels are designed specifi-

cally for applications in desktop electronic calculators, automobiles, scales, clocks and voltmeters.

Unit price is \$29.57, and this goes down gradually for quantity orders until the price per panel in lots of 1,000 is \$15.38; and for 50,000, it is \$8.40 each. Connectors and mounting brackets are optional items. The panels are available from stock in small quantities and will be ready in production quantities within four or five weeks.

In another diversification step, Cherry has disclosed that it is ready to start marketing hand-held calculators under its own brand name. For several years, the Illinois company has been producing calculators that are being sold under other brand names.

Cherry Electrical Products Corp., P.O. Box 718, Waukegan, Ill. 60085 [341]

Potentiometer has digital display, push-button action

Panel designs requiring precision data-entry or set-point controls are among applications for a digital potentiometer that combines precision with a three-decade digital display and fast, push-button resistance selection in one package. Snap-in mounting is another feature of the unit, called the model 3680 Knobpot.

Integral design saves back-panel space, the company says. No external resistors, resistor networks or pc boards are required. The combination of laser-trimmed cermet resistor technology with positive push-button detent action results in a dial-readout accuracy of voltage ratio to within $\pm 0.5\%$. Resolution of output is 1 in 1,000 discrete steps, with repeatability specified as within $\pm 0.1\%$.

Temperature coefficient of the Knobpot is 100 ppm/ $^{\circ}\text{C}$, and power rating is 2 watts. Standard resistance range is 5 kilohms to 1 megohm, and resistance tolerance is $\pm 1.0\%$.

Prices range from \$23 each for one to nine down to \$17.04 each for 100-249 and lower for larger quan-

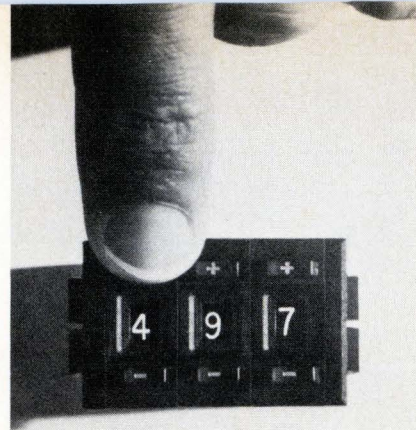

ties. Delivery of small quantities is from stock.

Bourns Inc., Trimpot Product Sales, 1200 Columbia Ave., Riverside, Calif. 92507 [342]

Relays offer compatibility with DTL, TTL circuits

Both electrical and dimensional compatibilities with TTL and DTL integrated circuits are offered in a family of electromechanical relays built around a magnetic circuit and contact design. The four-pole, double-throw relays are available in dual in-line packages, which are 0.43 inch high by 0.63 in. wide by 0.95 in. long. The relay pins are arranged on 0.1-in. centers in two lines 0.3 in. apart so that the packages can be plugged into standard DIP sockets or soldered into the 100-mil-hole grid of a printed-circuit board. Three basic types of relays are available in a variety of coil ratings, pin configurations, and mountings: type 21 sensitive relays, type 25 magnetic-latch relays, and type 28, a three-position OR-function design with a dual coil. Typical price in production quantities is \$5.50 for a type 21 relay.

Electrodyne Inc., 2126 Adams St., Milwaukie, Ore. 97222 [343]

LEDs match frequency response of optical fibers

Featuring a significant improvement in switching speeds over other units on the market, a line of infrared LEDs is also closely matched to the frequency response characteristics of fiber-optic cable. Peak emission wavelength for the units is 885

Cinch has the extras in .100" PC edge connectors

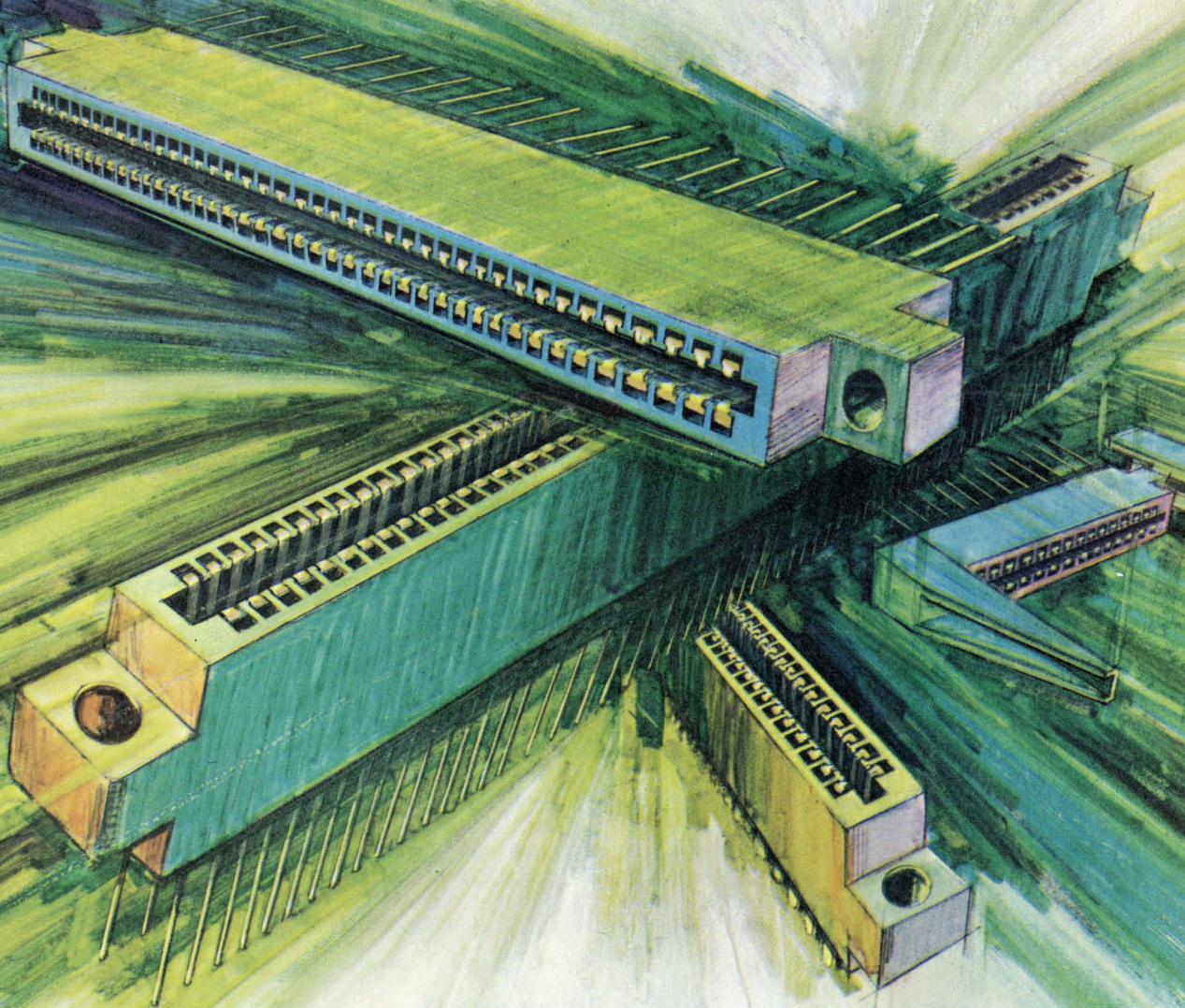

Extras that result in higher reliability, wider availability, and greater economy are integral to these TRW/Cinch edge connectors:

- Gold-plated contact reliability at a lower cost through Cinch selective plating (30 microinches on board contacting areas and 10 microinches on non-contacting areas).
- Cantilevered contact construction results in gap uniformity and controlled insertion and withdrawal forces, due to preloading of bifurcated contacts against insulator stop.
- Available in 16 sizes, from 10 to 50 double readout contact positions, with choice of wire wrap*, dip solder

or solder tab terminations, and detachable card guides, for added versatility.

- Nation-wide stocking by TRW/Cinch distributors of six popular sizes (15, 22, 36, 40, 43, and 50 positions) for off-the-shelf availability.

For additional information, see detailed listings in EEM, contact your nearest TRW/Cinch sales office, or dial toll-free (800) 645-9201 for the name of your nearest TRW/Cinch distributor. Or write for Catalog C-24, describing the complete line of printed circuit edge connectors, to TRW/Cinch Connectors, an Electronic Components Division of TRW Inc., 1501 Morse Avenue, Elk Grove Village, Illinois 60007; phone (312) 439-8800.

*T.M. Gardner-Denver

CM7404

TRW® **CINCH CONNECTORS**

Circle 137 on reader service card

New and improved General Electric lamps provide for increased design flexibility.

Two new sub-miniature halogen cycle lamps ideal for miniaturization.

These new T-2, 6.3V, 2.1 amps, 75 hour GE halogen cycle lamps are the smallest of their type (.265") and set industry standards for size and light output (16-20 candlepower). They are perfect for miniaturization of equipment such as reflectors, housings and optical systems. They also save on overall cost of equipment and are less than half the cost of the #1973 quartz lamp they replace.

Two terminal configurations are available. #3026 (20 candlepower) has wire terminals. #3027 (16 candlepower) has a new two pin, ceramic base that plugs in to make installation and removal a snap. Samples of the #3027 lamp are available in limited quantities now; production quantities will be available in the first quarter of 1975. These lamps have an iodine additive that creates a regenerative cycle that practically eliminates normal bulb blackening. They will produce approximately 95% light output at 75% of rated life.

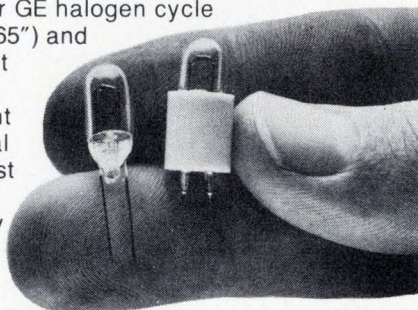

An expanded line of Wedge Base Lamps for simple, low-cost circuitry.

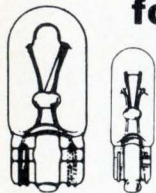

Now you can have greater design freedom than ever before with wedge base lamps. GE now offers six large lamps in its line of T-1 $\frac{3}{4}$ (.230" max.) all-glass, sub-miniature wedge base lamps. In addition to our three 14V lamps (#37, #73 and #74), we now also offer two 6.3V lamps (#84 and #86) and a 28V lamp (#85).

These lamps are ideal for applications where space is at a premium. Their wedge-based construction allows you to design for low-cost sockets and virtually ends corrosion problems because they won't freeze in the sockets. And the filament, which is always positioned in the same relation to the base, offers more uniform brightness.

Green Glow Lamp has been improved over previous lamp.



Actual Size

Now our G2B Green Glow Lamp, the only domestic green lamp on the market today, gives a more uniform, purer green light than our previous model. It's bright enough for your circuit component applications. With appropriate current limiting resistors, it can be used for 120/240 volt green indicator service. Or used together with our high-brightness C2A red/orange/yellow glow lamps to emphasize multiple functions with color.

All GE glow lamps give the benefits of small size, rugged construction and low cost — 12¢ each for the G2B, 4.4¢ each for the C2A in 100,000 quantities.

Send today for newest literature.

For the most up-to-date technical information on any or all of these lamps, write: General Electric, Miniature Lamp Products Department, #0749-M, Nela Park, Cleveland, Ohio 44112.

GENERAL  **ELECTRIC**

New products

nanometers; fiber-optics cable typically has maximum transmission at about 820-830 nm. The 3-dB bandwidth is 10 MHz so that the LEDs produce flat output over a range of frequencies. Applications include card and tape readers, material-sorting systems, couplers, and proximity switches. In quantities of 100 to 999, prices range from \$1.50 to \$3.20, depending on specifications.

Semiconductor Division, International Rectifier Corp. 233 Kansas St., El Segundo, Calif. 90245 [344]

Indicator light is bezel-mounted

The series 5600 indicator light is bezel-mounted for assembly into any panel face, and spring legs on the case snap into a secure position. Six lens colors are offered: white, red,

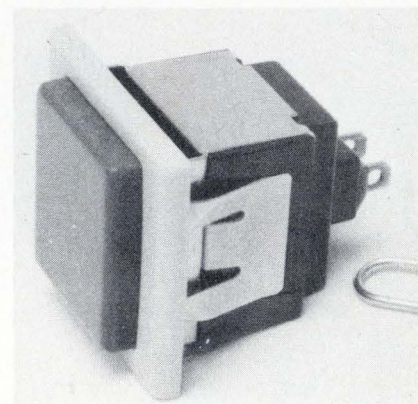

orange, yellow, green, and natural. Bezel size is 0.937 by 1.035 inches, and lens size is 0.746 by 0.656 in. End-to-end dimension is 1.209 in. Price ranges from 79 to 87 cents each, depending on quantity.

C&K Components Inc., 103 Morse St. Woburn, Mass. 02172 [350]

Trimmer potentiometer is rated at 0.2 watt

A low-profile 10-millimeter composition trimmer potentiometer, designated series 260, offers a serrated, slotted knob so that adjustment can

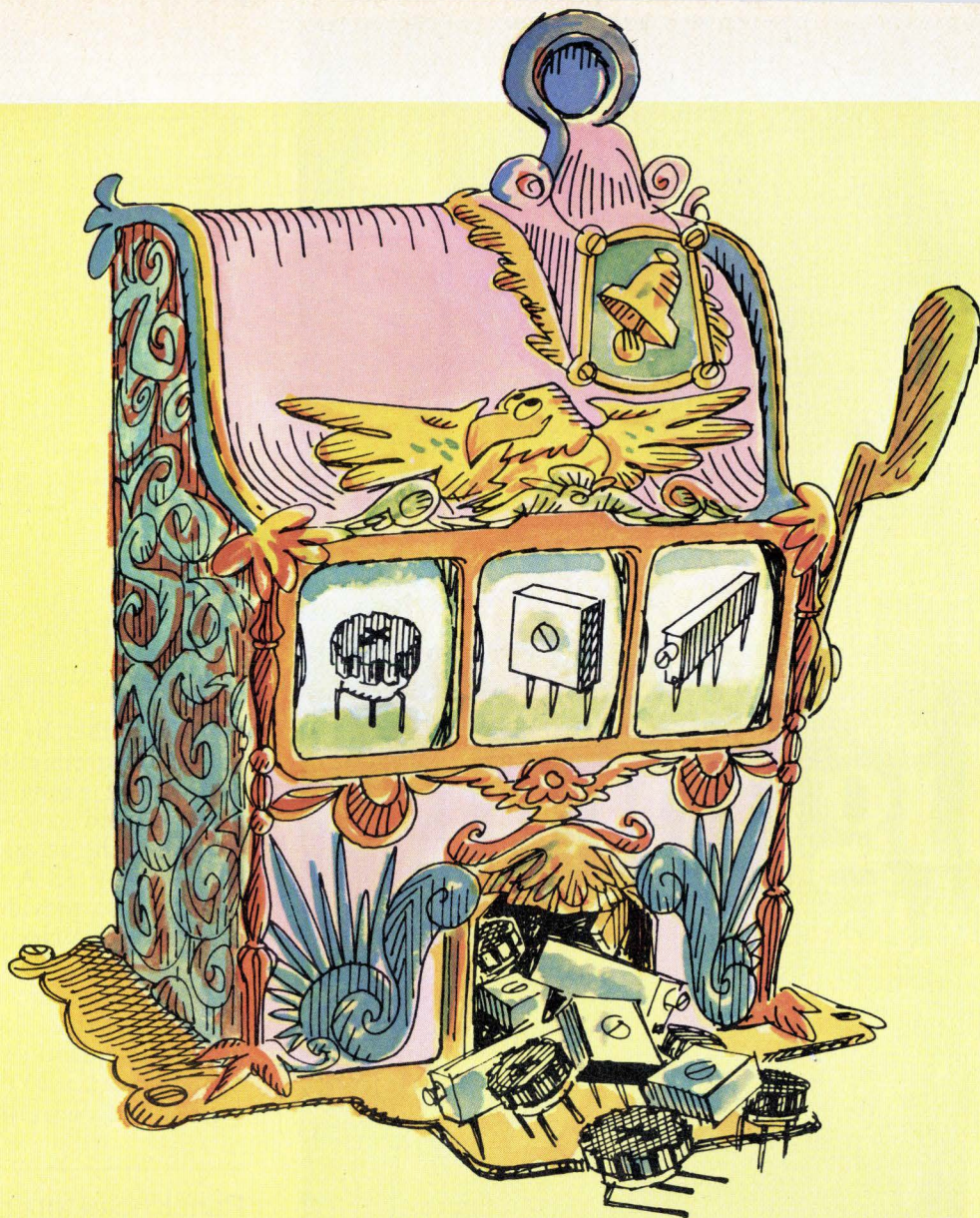

Take the gamble out of trimmer buying.

Three of the winners in our extensive cermet trimmer line can give you a sure jackpot, because, right now, they satisfy over 90% of all trimmer requirements and board layouts.

Pick the 3/8" square, single-turn, sealed Model 72. Or the 3/4" rectangular, multiturn, sealed Model 89. Or the 3/8" diameter, covered, single-turn Model 91. Each in 19 standard resistance values from 10 ohms to 2 megohms...and in a variety of pin spacings.

Prices are right, too. Models 72, 89, and 91 are respectively just \$0.53, \$1.01, and \$0.41 in the 500-piece quantity.

And after all that, if exceptional setability

and 100 ppm°C tempco isn't enough, think of this: They're all available for immediate delivery from stock at your local Beckman/Helipot distributor!

Considering the stakes in your own competitive field, you should look into the quality and performance of Beckman cermet trimmers.

If you need immediate technical literature or the phone number of your local Beckman/Helipot representative, call toll-free (800) 437-4677.

Beckman
HELIPOT DIVISION

When you
specify High-Rel Hybrids,
specify
Highbrids
from Raytheon/Quincy

Highbrids because they combine high reliability, high performance and high technology in a beam lead or chip-and-wire package.

Highbrids are the *only* hybrids we make at Raytheon/Quincy. Because we're high on the military and medical electronics markets. In fact, that's where 98% of our Highbrids are used.

All our Highbrids are custom engineered and are the most advanced design units available.

So, if you don't know all about Highbrids from Raytheon/Quincy, it's high time you do. Contact Mr. K. Singh at Raytheon Company, Industrial Components Operation, 465 Centre Street, Quincy, Mass. 01810. (617) 479-5300.

RAYTHEON

New products

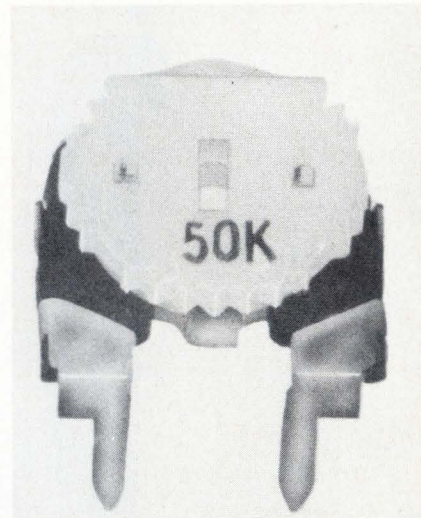

be made either by hand or with a screwdriver from either the front or rear. Power rating is 0.2 watt at 55°C, derated to no-load at 100°C. Voltage rating across the end terminals is 350 v dc. A wide resistance range is also provided, from 1 kilohm through 5 megohms (linear taper) with a tolerance of $\pm 30\%$. Special resistances are also available. Price is less than 7.5 cents each in production quantities.

CTS of Canada Ltd., 80 Thomas St., Streetsville, Ontario, Canada [345]

Panel indicators put out
3 millicandelas at 20 mA

A line of solid-state panel indicators using low-voltage gallium-arsenide-phosphide light-emitting diodes offers a light output (red or green) of 3 millicandelas at 20 milliamperes. Encapsulated in molded nylon, the units snap-mount into the

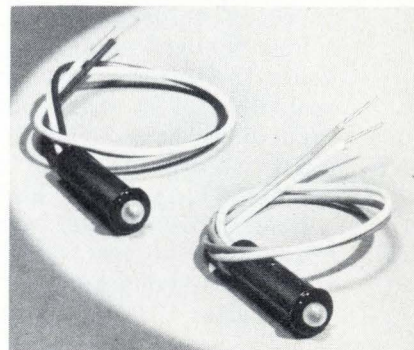

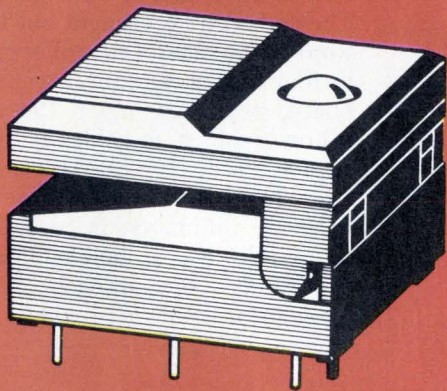
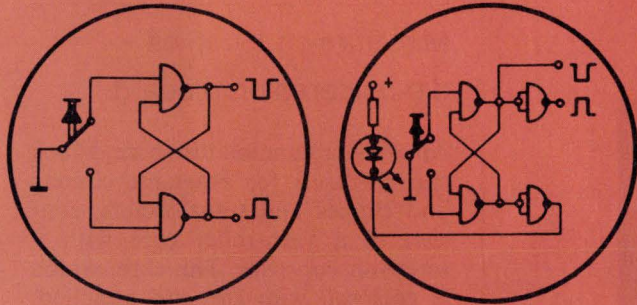
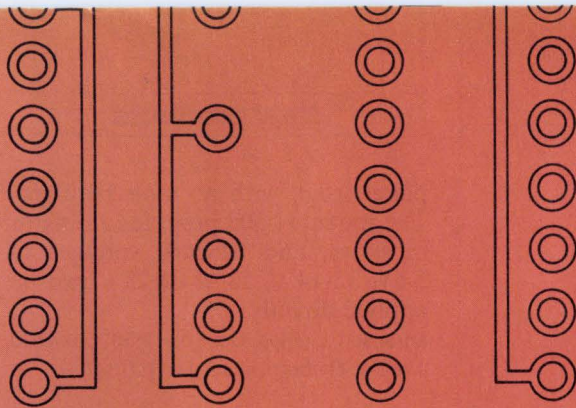

Digitast™

modular electronic
switch input component

Circle 141 on reader service card

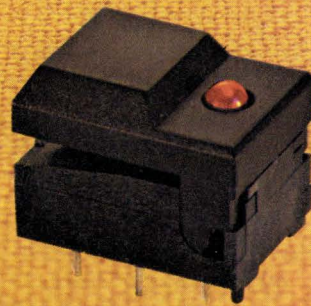

digitast

SRL (LED factory installed)
12.3mm wide x 17.1mm

STL (LED factory installed)
17.3mm wide x 17.1mm



digitast

SR 12.3mm wide x 17.1mm
ST 17.3mm wide x 17.1mm

Digitast is a remarkable new modular electronic switch input component for use with dual in-line packages (DIP). The inner construction eliminates more costly and troublesome conductor plate sandwiched switches.

The single pole, double throw momentary contact element is made of gold-plated over nickel-plated brass wire. Included in the contact arrangement is a unique bussing contact precluding the need for double-sided printed circuit boards in most applications. The design of the Digitast housing around the outer contacts prevents wicking of flux or solder.

The contact arrangement of the DIP also lends itself to economical PC board designs and assembly techniques of sophisticated electronic equipment.

The modular design allows simple plug-in capability, including 2 PC board locator pins and 4 PC board stand offs for flush, parallel mounting. A crisp, consistent tactile feel is achieved through the use of a spring-loaded, vibration-free inner contact arrangement. Two standard button sizes are available: the 12.3mm and 17.3mm widths, with or without light emitting diodes (LED).

Digitast's uncomplicated construction allows you to economically design varied button configurations to your individual requirements.

Pushing the button applies pressure to the cross bar switching mechanism, in connection with the single pole bussing feature, preventing contact bounce and insuring constant electrical output.

Digitast is innovatively designed for incorporation into the sophisticated electronic equipment of today and tomorrow.



SCHADOW
AMERICA, INC.



INTERNATIONAL ELECTRO EXCHANGE CORPORATION

8081 Wallace Road, Eden Prairie, Minn. 55343

612/944-1820 • TWX 910-576-2469

Manufacturing facilities in Minneapolis, Minnesota, Einbeck, W. Germany and W. Berlin.

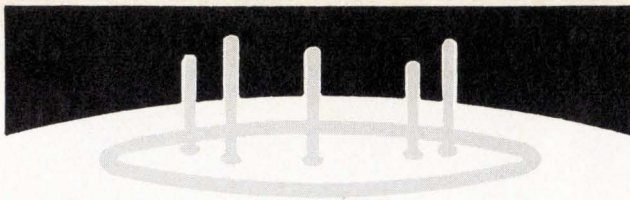

How can short-exposure X-ray images be created without film or processing?

How can industrial monitoring systems freeze and display transient images (such as flaws on steel strip)?

How can slowly scanned images (such as thermographs) be stored and displayed without film — and at lower cost?

How can high-resolution pictures be sent through narrow-bandpass facilities?

How can doctors obtain non-fading EKG records without paper or film?

WITH
**extra-
vision™**
THE UNIQUE
Lithocon II™
IMAGE STORAGE
SYSTEM AT WORK
IN THE PEP
SCAN CONVERTER

Now you can scan a frame once, at any speed from DC to megahertz. And store it for up to an hour with 64 levels of grey scale (or up to two hours in pure black and white). A fine, stable, high-resolution picture rivaling wide-band, closed-circuit television.

Extra-vision captures a transient or single-scan image and displays it in hard-copy quality without hard-copy cost and delay. You can selectively erase and rewrite a portion of an image. Or zoom in to magnify up to 36X without altering the stored image.

The image can be read out in any video format and at any scan rate, continuously refreshing as many monitors as required. In any mix of sizes.

If you have an image-processing application, you may be surprised at the techniques made possible by the Lithocon II silicon-target storage tube.

The five applications cited here are from a long list of actual systems. Please tell us about your image-processing activity. We may have some ideas for you.



**PRINCETON ELECTRONIC
PRODUCTS, INC.**

P.O. Box 101, North Brunswick, N.J. 08902
(201) 297-4448

New products

panel front, with no tools required. The model N-503 provides a resistor in series, and forward voltages of 5-6v, 12-14 v, 18 v, or 28 v can be applied directly.

Sorenson Lighted Controls, 530 Oakwood Ave., W. Hartford, Conn. 06110 [347]

Miniature core can be dip-soldered onto board

An adjustable miniature core, which can be used for resonant circuits and chokes and transformers, consists of a yarn-roller core with a screw-on cup core. The core, which is enclosed with the cup attached, can be dip-soldered on a pc board. The ends can be brought out to two wires in the base of the roller core or to four solder tags on a connecting board, depending upon the application involved. Q values as high as approximately 200 can be achieved, and when positioned, the core measures 4.6 millimeters in base diameter and 5.5 mm in height. Price for 1,000 units is 90 cents each.

Siemens Corp., 186 Wood Avenue South, Iselin, N.J. 08830 [346]

Cartridge lamps are rated at 10 and 20A

Part of the Littelite series, a family of cartridge indicating lamps has a plastic lens attached to an aluminum sleeve which houses a solid-state, incandescent, or neon lamp. The lamp is welded to two 0.40-inch-diameter stainless-steel pins that are offset for polarization and for positive mating of the unit to the cartridge lamp holder. The 900 series solid-state units employ a gallium-phosphide or gallium-arsenide-phosphide light-emitting diode for voltage ranges of 1.8 to 28 v with built-in resistance for nominal current ratings of 10 and 20 milliamperes. The incandescent units use subminiature filament lamps 1/4 inch or smaller in diameter.

Littelfuse Inc., 800 East Northwest Highway, Des Plaines, Ill. 60016 [348]

The MACRODATA MD-107 Memory System Analyzer!

Imagine a tester that can handle plated-wire, core, or semiconductor memories... that can test complete computer memory systems, memory boards, or memory chips... that can operate at 10 MHz and compare up to 160 data bits at any of 16,000,000 addresses.

The Macrodata MD-107 Memory System Analyzer does it all.

- Macrodata's Cascaded Computer Control Testing Concept
- Minicomputer, Microprogrammable Processor, and CRT Display
- Key-

- board Entry of Test Programs
- Split Cycle Timing Capability
- Sophisticated Address Manipulation Capability
- Simple Software Language with Display of Directive Action for Operator Based on Test Results
- Extensive Sync Capability
- CRT Display of Device Inputs/Outputs for Test Monitoring
- CRT Message Display for Easy Program Debug
- Complete system under \$50,000.

For the full story, send for the MD-107 brochure, or call us directly.



SYSTEM BLOCK DIAGRAM

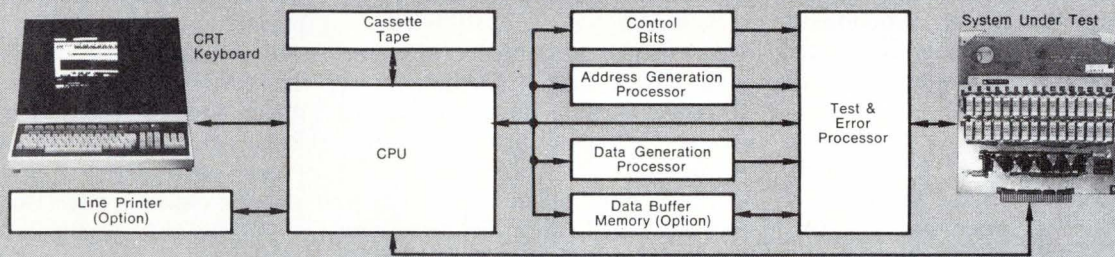

Macrodata



Macrodata Corporation, 6203 Variel Avenue, Woodland Hills, California 91364, Phone: (213) 887-5550, Telex: 65-1345
 Sales Offices: Northern California Area Tel. (408) 735-9560 • Scottsdale Tel. (602) 966-2179 • Minneapolis Area Tel. (612) 454-2034 • Chicago Area Tel. (312) 297-8746 • Cleveland Area Tel. (216) 461-8333 • Dayton Area Tel. (513) 293-3145 • East Coast Tel. (516) 543-8600 • Florida Area Tel. (305) 922-5230
 International: West Germany - Munich Tel. (0811) 34 56 00 Telex: (841) 529-448 • Milan, Italy Tel. 871-988/899-248 Telex: (843) 34314 • Sweden and Norway - Stockholm Tel. (08)-380-370 • Tel Aviv, Israel Tel. 25 55 69 • Tokyo, Japan Tel. (03) 985-5266 Telex: (781) 272-2171 • Berkshire, England Tel. (0628) 30151
 Paris (Suresnes), France Tel. 772-3108 Telex: MB61450F

Circle 143 on reader service card

Instruments

**Test program
can be edited**

System for in-circuit check
of ICs can be programed,
debugged on line or off

The ability to edit and debug programs without interrupting production testing is a valuable asset in any test system. That's why Systemation provides as an accessory a program-editing console for its latest in-circuit component test system, designated the model 731. With the program editor, the user can write and debug programs either online or offline.

The 731 system, which incorporates integrated-circuit logic, can be used with a disk memory that increases the capacity for storage of test programs, compared to previous Systemation models that used core memory only.

The 731, called Fixit, tests circuit wiring, checks the physical orientation of polarized components, and performs in-circuit measurements of values and characteristics of components, except for a few cases—claimed to be less than 2%—where circuit conditions prevent the application of the necessary guarding technique. It can functionally check digital and linear integrated circuits at approximately 25 tests per second.

The program-editing console interfaces with disk or core memory and enables program writing and debugging as well as inserting changes resulting from design modifications in electronic assemblies. It has an automatic-search feature, to facilitate editing magnetic tape cassettes for off-line storage. The cassettes store 144,000 eight-bit characters per track, with two tracks per tape. One console can be used to service several Fixit and memory installations. The keyboard on the console can be used to operate Fixit

manually, as a user might want to do during debugging. Using a quiet electronic printer, the editing console provides a hard copy of the program. One console can be multiplexed with up to four test systems by addition of interfaces.

Either a core memory or a disk memory may be used. The core memory has a basic capacity of 16,000 eight-bit words, expandable in increments of 16,000 to a maximum of 64,000.

The disk memory system can be a sealed disk with a capacity of 2.4 million bits, or a replaceable type with a capacity of 24 million bits per replaceable disk cartridge. When used with either core or disk memory, Fixit 731 increases throughput approximately 40%.

Fixit operates from a punched-tape program. The tape is read at 1,000 characters of 8 bits each per second.

In addition, Systemation has developed a computerized system for writing programs. On the average, computerized program-writing is accomplished in about ¼ the time required for manual writing. Also, debugging of the program usually requires less time.

Systemation Inc., Clifton Park, Elnora, N.Y. 12065 [351]

**Adapter extends ac range
of hand-held multimeter**

An rf probe adds the ac measurement range from 100 kilohertz to 500 megahertz to Hewlett-Packard's model 970A hand-held multimeter. Accuracy in this range is said to be within 1 dB. Voltages from 0.25 to 30 v full scale can be measured with the probe, called the model 97003A rf adapter. Maximum ac input is 30 v rms plus 200 v dc. The basic pocket-sized 3½ digit multimeter measures ac and dc voltage and resistance. Its ac voltage range is from 100 microvolts to 500 v, 45 Hz to 3.5 kHz, and input resistance on the ac range is 10 megohms; the model 97003A extends the usefulness of the multimeter into the rf re-



gion. Input resistance of the adapter is greater than 25,000 ohms, shunted by less than 4 picofarads. Price is \$85.

Inquiries Manager, Hewlett-Packard Co., 1501 Page Mill Rd., Palo Alto, Calif. [355]

**Counters offer resolution
of 100 nanoseconds**

Four new universal counters and one universal counter/timer offer frequency ranges from 10 hertz to: 80 megahertz, 200 MHz, and 1 gigahertz. LSI MOS circuitry allows each counter to have 100-nanosecond time resolution and low power consumption for the digital circuitry. In the rf channel, there is a multistate p-i-n diode circuit that attenuates the input signal to a level just above 5 to 6 millivolts, the value of the trigger window. The PM6610 family performs frequency, single-period, period-average, totalizing, and multiple-ratio measurements. The PM6612 counter/timer can also make time-interval measurements. Price ranges from \$790 to \$1,750.

Philips Test & Measuring Instruments Inc., 400 Crossways Park Dr., Woodbury, N.Y. 11797 [353]

**Digital-circuit analyzer
aids troubleshooting**

Designated the Datatester 4000B, a redesigned digital-circuit analyzer eliminates expander-board requirements and comes with 60 outputs. The output is selected by thumb-

First, the Fabulous 43...

Then, the Super 70...

And now--

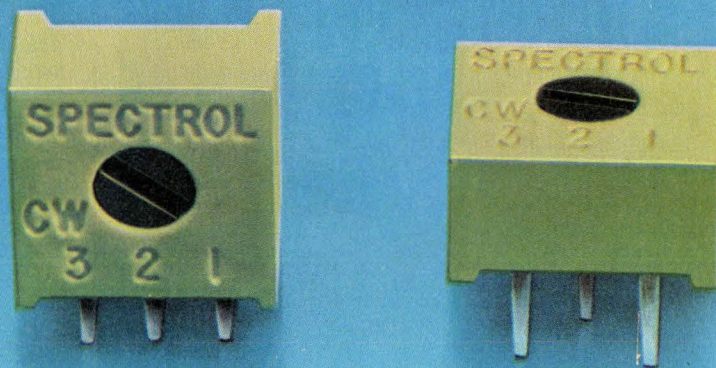

The "Set-sational" 63!

If you liked our $\frac{3}{4}$ -inch and $1\frac{1}{4}$ -inch rectangular cermet trimmers, you'll love our new single-turn $\frac{3}{8}$ -inch square cermet, the Model 63. Its superior Spectrol design virtually eliminates springback problems and provides reliable setability. It plugs right into those 362, 3389, and 72 sockets, and it's competitively priced.

The 63's are available from the factory and 75 distributor outlets. For free samples, all you have to do is ask.

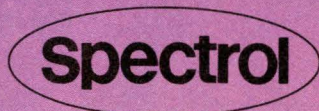

SPECTROL ELECTRONICS GROUP

UNITED STATES Spectrol Electronics Corporation 17070 E. Gale Avenue, City of Industry, Calif. 91745, U.S.A. • (213) 964-6565 • TWX (910) 584-1314

UNITED KINGDOM Spectrol Reliance Ltd. Drakes Way, Swindon, Wiltshire, England • Swindon 21351 • TELEX: 44692

ITALY SP Elettronica spa Via Carlo Pisacane 7, 20016 Pero (Milan) Italy • 35 30 241 • TELEX: 36091

Circle 145 on reader service card

PRECISION CONTROL

with the **SERIES 300 CONTROL TACHOMETER**

"The EVENT CONTROLLER that DOES IT ALL"

OVERSPEED, UNDERSPEED PROTECTION

PROVIDES START-UP

TURBINE OVERSPEED ALARM & CONTROL

SEQUENTIAL SWITCHING

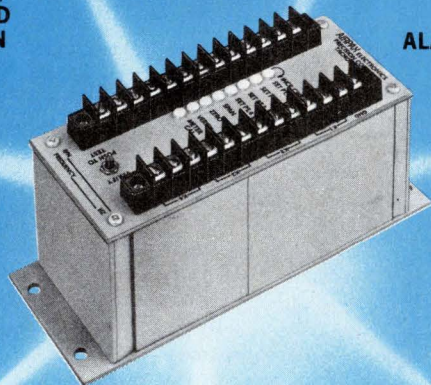

CONVEYOR PROTECTION

MACHINE CONTROL

MONITOR SHAFT RPM

The 300 Tachometer is compact and solid state. It will accept signals from many types of sensors . . . will operate from signals produced by magnetic or zero-velocity type pick-ups mounted in proximity to a rotating gear. Up to 4 switch points can be provided. Analog control outputs, verify features, selectable relay logic and other standard options are available.

Bulletin 8511-574 gives complete details and specifications.

**AIRPAX Controls Division P.O. Box 8488
Fort Lauderdale, Florida 33310 Phone: 305/587-1100**

AIRPAX™

New products

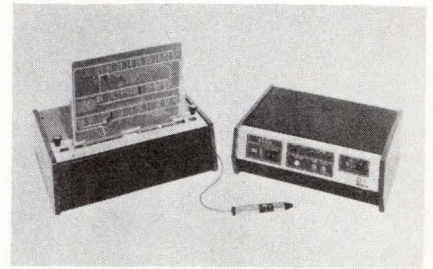

wheel, and a crystal-controlled test clock provides rates of 125 kilohertz to 2 megahertz. The system is good for troubleshooting and rework stations. It functionally tests outputs at the rate of 5 seconds per output. The 4000B, which handles DTL, TTL, MOS, C-MOS and ECL, exercises every circuit element in every test and pinpoints faults, including intermittent failures. Price of the analyzer is \$4,995.

Data Test Corp., 2450 Whitman Rd., Concord, Calif. 94518 [354]

**Laser power meter covers
440 to 680 nanometers**

A laser-power meter provides direct power readout at any wavelength from 440 nanometers to 680 nm in 1-nm steps. It is designed for use with any type of visible cw laser from the submilliwatt helium-neon devices through the cw dye types to 10-watt argon lasers. The model 504 power meter presents a flat response over most of the visible-wavelength range by using internal electronic compensation. By dialing on the front panel the wavelength being measured, the laser power can be read directly for any wavelength. Laser power from a fraction of a milliwatt to 10 w can be measured on the 504 in seven ranges (10 mw, 30mw, 100 mw, 300 mw, 1 w, 3 w,



NOW THERE'S A MASS-PRODUCED LASER TO TAKE YOU TO YOUR MARKETS ECONOMICALLY.

Spectra-Physics, the world's leading laser manufacturer, has achieved the breakthroughs necessary to mass-produce a high-quality laser that meets all the requirements of a true system component.

The Model 136 is priced 30% to 40% below most other low-cost helium-neon lasers. It culminates three years of intensive research, development, and testing by Spectra-Physics. Its introduction marks a turning point in laser reliability and in the ease with which lasers can be set to a precise power level, installed and aligned in equipment. In most applications you never have to touch it again for the useful life of the system.

This revolutionary laser is inexpensive, precise, and reliable. It is easily adapted to a large variety of applications with minimum technical and packaging involvement by the system manufacturer. These applications include products for the home, business, and industrial use—video record players, recorders, optical copiers, scanners, pollution monitors, industrial measuring instruments and alignment systems.

Instead of a bare, fragile tube, you get a hermetically-sealed metal cylinder only $1\frac{1}{8}$ inch in diameter and less than a foot long. It contains the tube, beam power control, shock mounts, thermal stress reliefs, ballast circuit, and safety ground. The Model 136 has been designed to operate reliably in the toughest of environments—it even works under water.

You can adjust output power from less than 1 mW to more than 2 mW,



with full consideration of all applicable safety regulations. To assure interchangeability with little or no realignment, the beam is concentric within 0.05 millimeters of the package's precision alignment surfaces.

Typical continuous operating life is more than 20,000 hours—twice



that of most other lasers and electronic products. And this laser requires only 6 watts from a system supply. Or you can buy plug-in subsystems with sealed power supplies that draw less than 0.2 amps from a 115V AC line or less than 9 watts of battery power.

Yet the Model 136 is priced under the so-called economy lasers that are less precise, less reliable, and less efficient. Its low cost results from our ability to mass-produce it without compromising performance.

The Spectra-Physics Model 136—whether you buy it in small quantities, in OEM discount volumes, or customized to meet your special needs, it's the only laser that can take you to your markets, economically.



Spectra-Physics

1250 West Middlefield Road
Mountain View, CA 94040 (415) 961-2550
Europe: 6100 Darmstadt. Alsfelder
Strasse 12 (06151) 75081

“We’ve Got A Great Instrument”



Carl Pehlke, President and Chairman

In fact, we’ve got a lot of great instruments. Perhaps we’ve grown complacent. Maybe we haven’t been ardent enough in telling our customers Texscan IS the world leader, with a complete line and a single source that no other has.

With our design and design capabilities, we’re coming on even stronger in the CATV, sweeper, spectrum analyzer, oscilloscope, attenuator and oscillator business.

We’ll be telling you more later. For now, though, why is Texscan *the* leading supplier? For openers, take a look at the chart below:

PRODUCT	Number of Models		
	TEXSCAN	TELONIC	WAVETEK
Laboratory Sweep Generators	26	8	7
Spectrum Analyzers	6	0	0
Display Oscilloscopes	3	3	1
Attenuators	83	18	8
Oscillators	149	0	0
Filter types	8	6	0

Based on latest catalog information

Texscan

THE WORLD LEADER AND
COMING ON EVEN STRONGER.

U. S. Sales Offices: Albuquerque 505-298-2575, Bayside (N.Y.) 212-423-7330, Binghamton (N.Y.) 607-748-0509, Blue Bell (Pa.) 215-542-1490, Cedar Rapids 319-363-2489, Cleveland 216-243-8430, Dallas 214-363-5291, Dayton 513-298-3033, Depew (N.Y.) 716-685-4111, Detroit 313-482-1229, Dover (N.J.) 201-366-7518, Hamden (Conn.) 203-288-5246, Hazelwood (Mo.) 314-731-5200, Hazlet (N.J.) 201-264-1851, Honolulu 808-941-1574, Huntsville (Ala.) 205-837-1601, Independence 816-737-1414, Indianapolis 317-257-7231, Los Angeles 213-478-1586, Mt. Penn (Pa.) 215-672-5565, Northbrook (Ill.) 312-882-7140, Orlando 305-859-2160, Palo Alto 415-494-3331, Seattle 206-763-2233, Syracuse 315-454-9314, Ulster Park (N.Y.) 518-372-6649, Winston-Salem 919-722-9671, Waban (Mass.) 617-969-3372, Wheaton (Md.) 301-942-9420. **Canadian Sales Offices:** Downsview 416-638-0218, Halifax 902-455-0670, Montreal 514-735-4565, Ottawa 613-728-4624, Vancouver 604-732-7317, Winnipeg 204-475-1732.

New products

10 w). The price is \$495, including attenuators for operation up to the 3-w range. The optional attenuator required for the 10-w range costs \$75.

Lexel Corp., 928 E. Meadow Dr., Palo Alto, Calif. [356]

Multimeter-counter operates to 10 MHz

The model 4440 digital multimeter-counter measures ac and dc voltage, ac and dc current, and resistance. Frequency-counting extends to 10 megahertz. The unit will operate for approximately six months from disposable alkaline batteries. Ac-line operation and rechargeable batteries are optional. Full-scale resolution is 1 part in 20,000, and dc voltage accuracy is within $\pm 0.05\%$. The crystal-controlled frequency counter resolves to 1 part in 100,000, with error held to 0.01%. Price is \$299.

Valhalla Scientific Inc., 7707 Convoy Ct., San Diego, Calif. 92111 [359]

Signal processors control X-Y automatic plotter

Designed to operate with the Nicolet family of real-time signal processors, the model 131E X-Y automatic plotter produces semiautomatic paper recordings of the spectrum outputs obtained from spectrum ana-



Some Delevan designs are very special...

THEY'RE NOT MADE YET.

Applications for inductive devices are virtually unlimited . . . and not even Delevan's broad line of *standard* designs can fit every requirement. That's where Delevan's Application-Engineering capability comes in! No matter how unusual or highly-specialized your application may be . . . Delevan can provide a custom-engineered design to meet the most demanding specifications, the most unique applications.

At Delevan, the design of inductive devices is far more than an art . . . it is a highly-sophisticated science. State-of-the-art techniques in winding and molding, the instant availability of computerized data, and utilization of new materials and procedures . . . combined with the proven expertise of Delevan engineers . . . equals unmatched capabilities. If you have the application, Delevan can provide the design.

Delevan
Division



AMERICAN
PRECISION
INDUSTRIES INC.

270 QUAKER RD. / EAST AURORA, N. Y. 14052
TELEPHONE 716/652-3600 TELEX 091-293

OTHER DIVISIONS OF AMERICAN PRECISION INDUSTRIES INC.:
BASCO • DUSTEX

Digital Timing Measurements The Easy Way.....

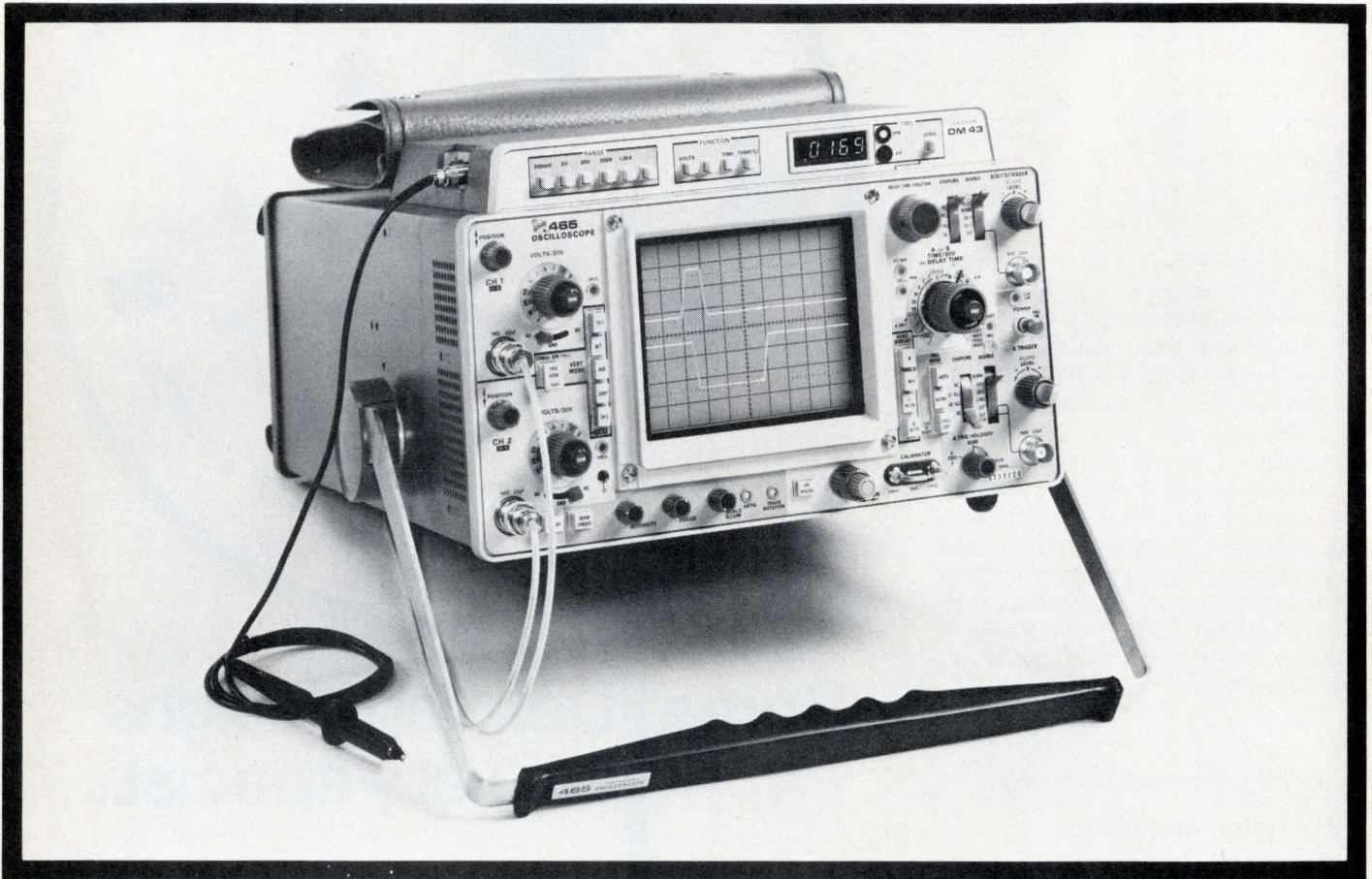

Digital timing measurement with improved resolution, 1% accuracy, increased freedom from error, faster operation, and greater operator convenience. The new TEKTRONIX DM43 with its unique direct numerical readout of time intervals adds all of these advantages to the field proven 465 and 475 oscilloscopes. What's more the DM43 includes precision digital meter capabilities as well. The DM43 is also available in the new 466 and 464 Fast Storage Portable Oscilloscopes. The DM43 provides a direct numerical readout of the time between any two points on the oscilloscope screen selected by the delay time position control. 3½ digit resolution and the 1% accuracy of the DM43/oscilloscope combination provide

convenient measurement of critical digital system timing in field servicing, in production, and in the design lab. Speed of measurement, freedom from error, and operator convenience are all improved since no dial readings or mental calculations are needed to arrive at a final reading.

Dc voltage measurement with an accuracy of 0.1% from 0 to 1200 V, resistance measurement within 0.75% over the range 0 to 20 M Ω , and the convenience of temperature measurement with a probe over the range -55°C to +125°C add still more to the versatility of the DM43. In field servicing, in production, and in design laboratory applications the DM43/Portable Oscilloscope combination provides the capability to meet almost any measurement need, and it's all in one compact package which can easily be carried wherever tests must be made.

With all of its added features the DM43/Oscilloscope combination is priced only \$475 above the price of the oscilloscope alone. A second model, the DM40, has all of the features of the DM43 except temperature measurement for only \$390.

To find out more about this unique innovation in portable instrumentation, contact your local Tektronix Field Engineer or write Tektronix, Inc., P.O. Box 500, Beaverton, Oregon 97005. In Europe write Tektronix, Ltd., P.O. Box 36, St. Peters Port, Guernsey, C.I., U.K.



For Demonstration circle 215 on reader service card

Circle 150 on reader service card

Logic Triggered Displays

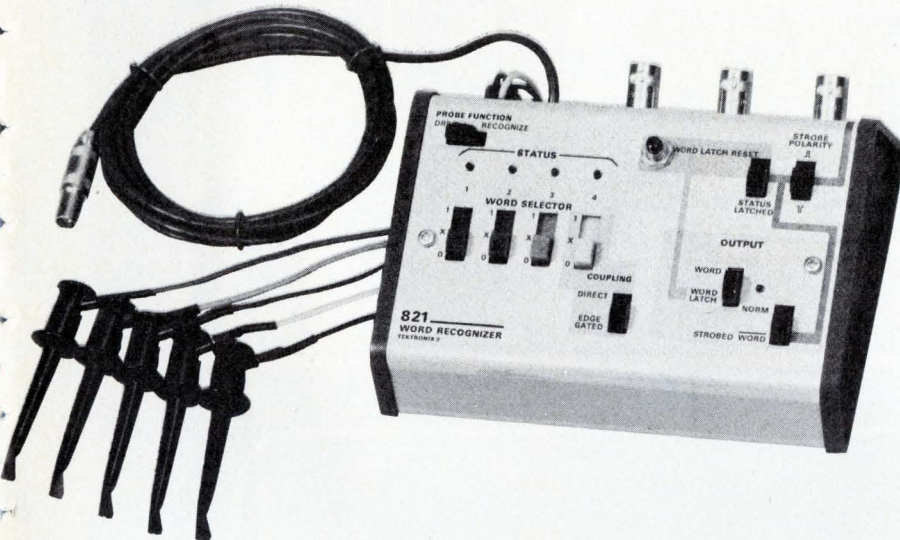

Stable oscilloscope displays of asynchronous logic sequences are easily achieved with a trigger from the TEKTRONIX 821 Word Recognizer. Or the 821 will work equally well with synchronous sequences that have no single unique sync point. As a digital trigger generator, the 821 combines your choice of four input logic signals to produce a single output pulse. Each input can be independently set to recognize a logical "1", "0", or "don't care" condition. And a different logic combination can be chosen as a trigger simply by changing these input recognition switches. Appearance of a specific op code in an instruction register, a predetermined count from a digital counter, or the occurrence

of a special set of logic levels at your system inputs can all be used for jitter-free oscilloscope triggering.

And the versatile 821 performs four additional functions. As a logic "babysitter" the 821 latches an output indicator light if the selected set of input levels is ever recognized. The absence of a selected logic combination at an external clock time can be indicated by a light or by a "fault" pulse. By simply supplying an external strobe, the 821 can be used as a four input logic probe capable of supplying timing information. In drive mode, the 821 forces operator selected logic levels at the four probe tips for troubleshooting static logic. All of these valuable logic diagnostic aids are offered in one pocket-sized unit for only \$200.

For more information on stable triggering on digital information contact your local Tektronix Field Engineer or write: Tektronix, Inc., P.O. Box 500, Beaverton, Oregon 97005. In Europe write: Tektronix, Ltd., P.O. Box 36, St. Peter Port, Guernsey, C.I., U.K.



For Demonstration circle 216 on reader service card
Circle 151 on reader service card

New products

lyzers in the company's fast-Fourier-transform UA-500 series, analyzers in the 400 series, and correlators in the 200 series. The recordings are automatically aligned with pre-printed grid lines on continuous-feed paper, thus eliminating the need to load and position sheets of paper between plots. Applications include those in which a large number of plots must be made in close succession.

Nicolet Scientific Corp., Northvale, N.J. 07647 [357]

Insulation testers provide accuracy within 1.5%

Two battery-powered insulation testers for servicing, production, inspection, and engineering applications are primarily used to determine electrical-insulation resistance

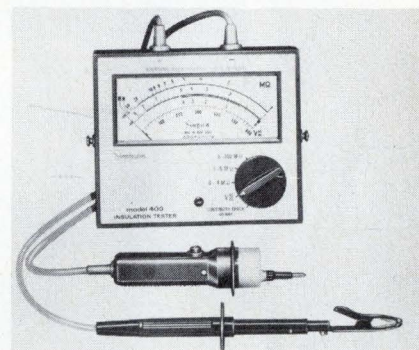

in electrical appliances, switches, motors, and other equipment. The units measure ac/dc voltage and make continuity checks in low-resistance circuits. The model 400 is designed to handle most tolerance requirements; it tests insulation at 500 volts dc, and measures ac or dc voltage as high as 600 v. Accuracy is to within $\pm 1.5\%$ full scale. An insulated negative test probe with a battery-saving operating button and built-in indicating lamp is also offered. A larger model, the 401, tests insulation at 1,000 v dc, and will measure ac/dc voltage as high as 1,000 volts. The 400 is priced at \$185 and the 401 at \$375.

Simpson Electric Co., 853 Dundee Ave., Elgin, Ill. 60120 [358]

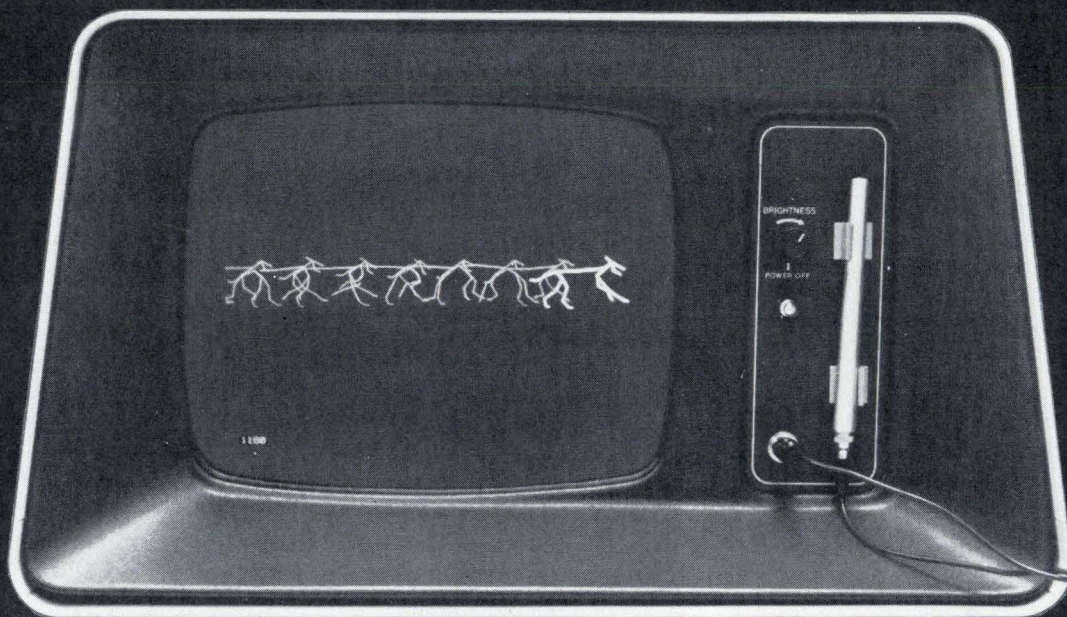
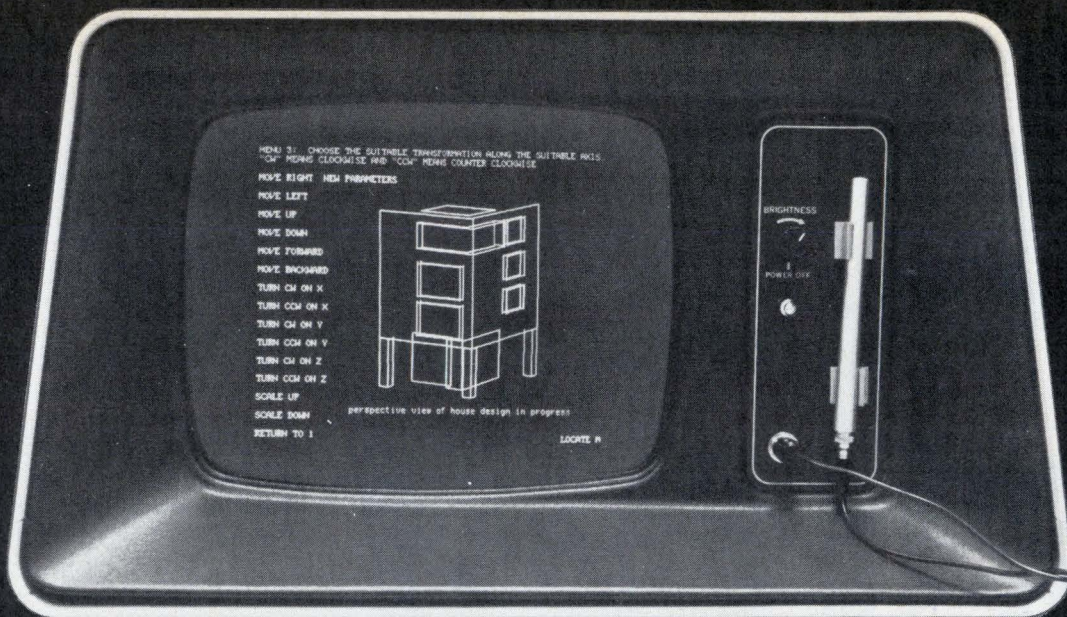

Digital announces a whole

Right now is the time to look at graphics in a way you've never looked before.

Because graphics has come of age. And Digital feels you're about to see a tremendous increase in the use of graphic systems. In science, research, medicine, business and industry.

Harnessing computer speed with visual display convenience has made it easier

and more effective to monitor, compute, evaluate and modify designs or events, wherever you want a better picture of the problem.

We're pointing this out to you because we're committed to meeting your graphic needs. In fact, we've been making graphic systems almost as long as we've been making computers. And today, we may have the broadest range of

computerized graphic systems available.

In our GT Series alone, Digital offers three multi-purpose graphic systems. The GT40's complete graphics capability includes a PDP 11/10 processor, 8K words of memory, keyboard, and 12" screen with light pen. Extensive peripheral and application software offerings are also available. For expanded needs, the

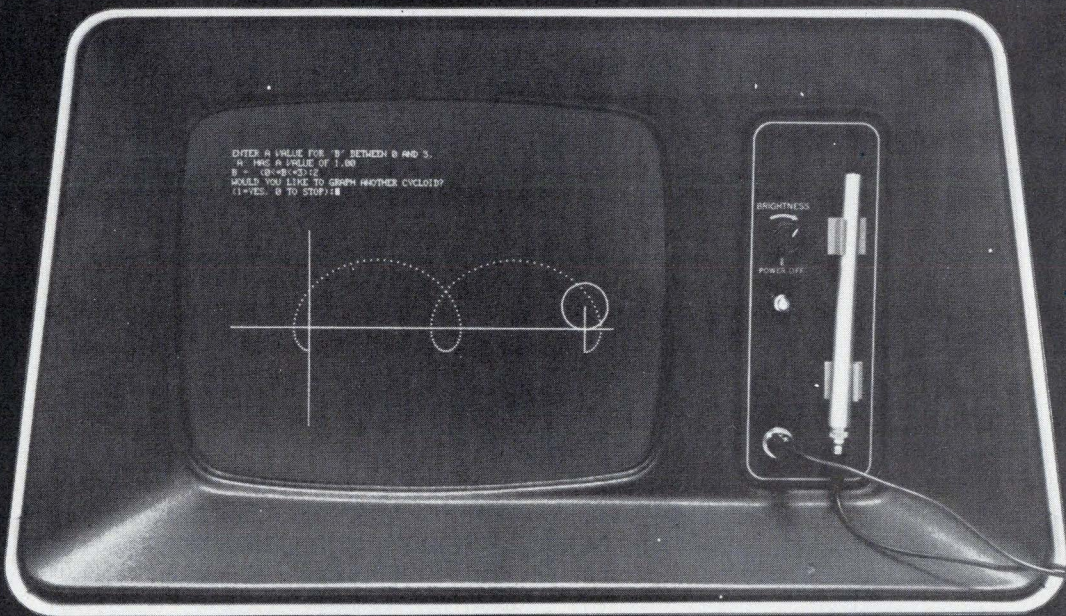
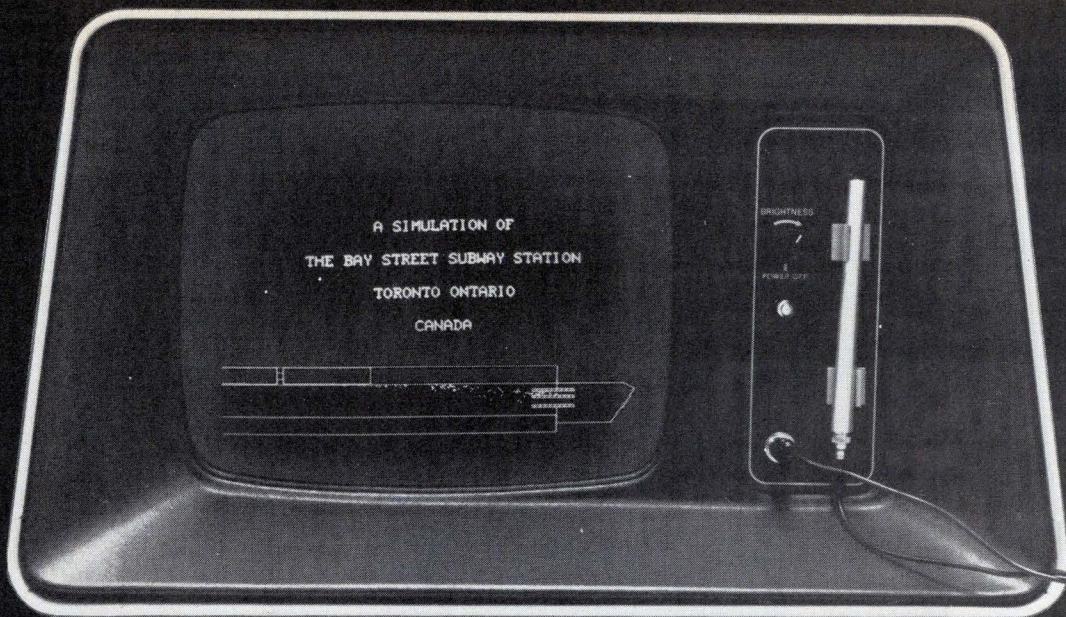

new way to look at graphics.

GT42 offers a 17" screen with light pen and communications interface. And a powerful GT44 system provides a high performance PDP 11/40 processor with 16K words of memory, 17" screen with light pen, and our own DECwriter for your hard copy needs. These are powerful, complete computer systems based on the PDP-11, the most popular 16-bit computer. Besides graphics, you

can use these systems for virtually any computer application. They're backed by an extensive array of peripherals and software. Plus Digital's worldwide service organization.

And should you already be a PDP-11 user, a graphic add-on may give you a totally new perspective on meeting your needs.

So if you're looking into graphics, be sure to see us.

Please contact your local Digital office. Or write Graphics Group, Digital Equipment Corporation, Marlboro, Mass. 01752. Or call (617) 481-9511, Ext. 6936. European headquarters: 81 route de l'Aire, 1211 Geneva 26. Tel: 42 79 50.

digital

Circle 153 on reader service card

To measure lower distortion than ever before

-- just push a button

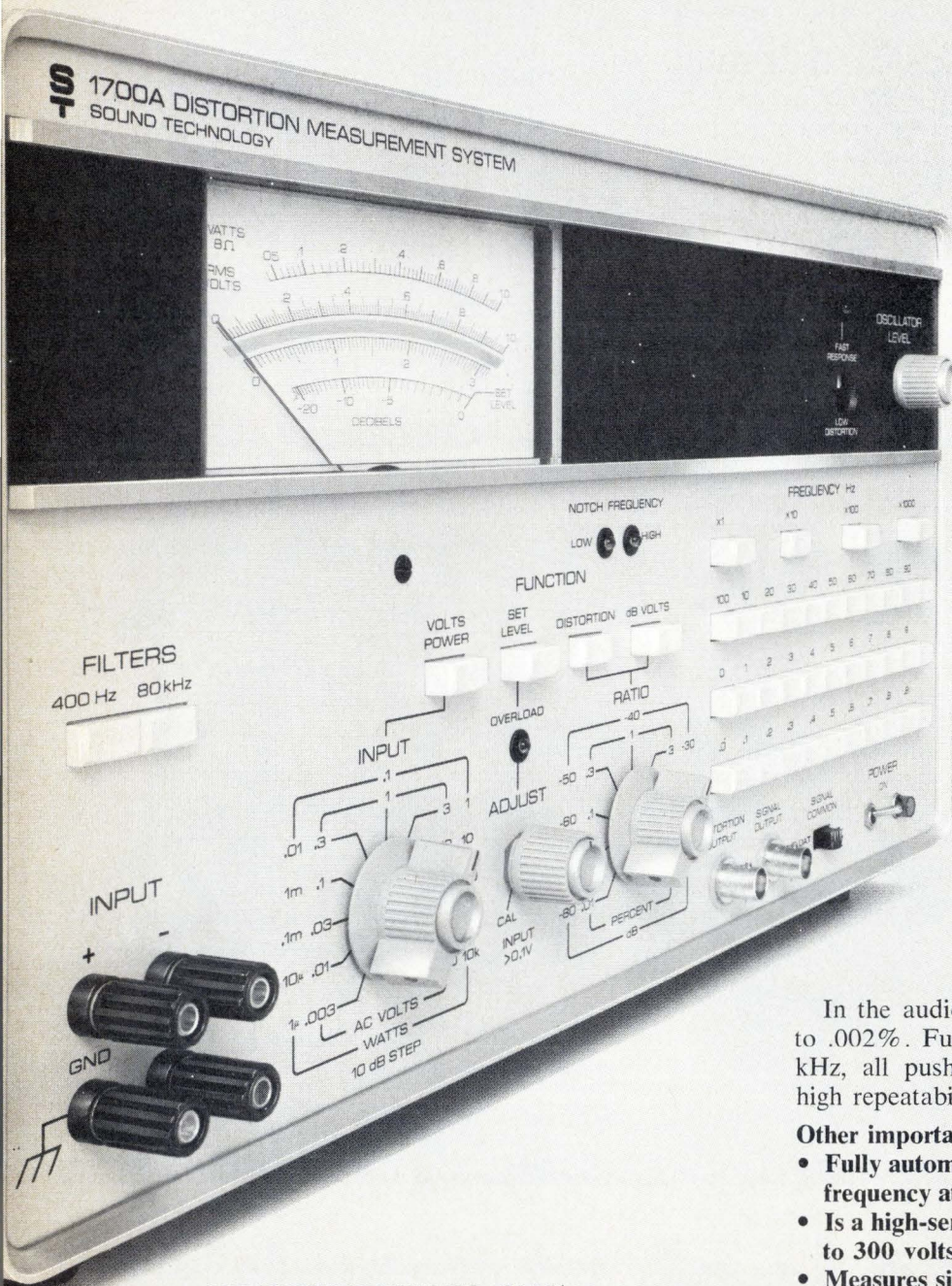

MEASURE DOWN TO .002%

Here is an important new system for measuring distortion.

This new Sound Tech 1700A is both an ultra-low-distortion signal source and a total harmonic distortion analyzer.

It's an instrument that's fast and easy to use. You can make a measurement in 5 seconds — because both source and measuring circuits are tuned by the same pushbuttons. Even non-technical production personnel can measure with it. And that can save a lot of test dollars in the plant and lab.

AUTOMATIC NULLING

In the audio range you can typically measure down to .002%. Full frequency range is from 10 Hz to 110 kHz, all pushbutton-controlled for fast selection and high repeatability.

Other important features:

- Fully automatic nulling — just push a button for frequency at which you want the measurement.
- Is a high-sensitivity AC voltmeter — 30 microvolts to 300 volts.
- Measures signal ratios up to 100 dB.
- Has differential input.
- Reads power in 8-ohm loads.

ECONOMICAL

The 1700A truly saves on initial outlay, too. It's only \$1485 (other models only \$1250). That's less than the cost of much lower performance oscillators and distortion analyzers.

MAKE PROFIT HAPPEN — CALL NOW

So don't get caught short. Make profit happen. Call Larry Maguire or Bob Andersen and get full performance data on this important new development.

ST

SOUND TECHNOLOGY

1400 DELL AVENUE
CAMPBELL, CALIFORNIA 95008
(408) 378-6540

DEVELOPERS OF THE INDUSTRY-STANDARD 1000A STEREO ALIGNMENT GENERATOR AND 1400A ULTRA-LOW-DISTORTION OSCILLATOR

Circle 154 on reader service card

New products

Semiconductors

Driver/receiver for bus systems

TTL quad package sends, receives signals on a bidirectional data bus

Because of the popularity of bus-organized digital systems, monolithic TTL bus driver/receiver circuits are being introduced to replace logic/driver assemblies. The newest is Teledyne Semiconductor's 6605 quad bus driver/receiver.

The 6605 is bidirectional. Each of the four circuits in the package allows data to be transmitted or received on a bus line and each bus line can carry information in either direction. It consists of four TTL open-collector bus drivers and four TTL bus receivers, with a common strobe-input gate. The strobe input determines the bus driver output state (either by gating the data input or presenting a high-impedance output). The receiver is always gated on. The bus output and receiver are common and connect to a single pin for easy connection to the data bus. The bus output can sink 100 milliamperes and thus can be operated into a twisted pair of flat cable lines, singly terminated in 50 ohms to the power supply voltage or terminated at both ends in 100 ohms to the power supply.

The features that make the 6605 novel, says Richard Goerner, product manager, are a high total bus capacitance of 450 picofarads, a very low nodal output capacitance of 8 pF, a typical propagation delay time of 35 nanoseconds, and noise-immunity.

The 6605's data-input-to-bus-output propagation delays are typically 35 ns, and while that appears to be not as fast as some other BDRs, it is measured with a 50-ohm, 450-pF load. Since the output node capacitance is 8 pF, this means it is possible to drive a large bus with 300

pF and still attach 20 devices to it. If the loads are lighter (either less bus capacitance or fewer BDRs), the 6605 can go faster. If the conventional 50-pF load measurement is used, the propagation delay drops down to about 20 ns.

The receiver inputs normally connect to TTL subsystem logic, so they have the normal TTL fanout of 10. Inputs from the system logic are standard TTL that is fully buffered.

Goerner says the 6605 has been optimized to give a very high system noise-immunity. Most BDRs have noise margins higher than the 400 millivolts of standard TTL. The 6605 gains a full 1.0 volt additional noise margin by having relatively high logic thresholds of 1.4 and 3.0 V (TTL is 0.9 and 2.0 volts).

The 100-mA output sink capability means the bus can be terminated with 100-ohm resistors, which gives the whole bus structure good noise-immunity. The termination technique dampens noise or ringing (logic signals reflecting back from inadequately terminated line ends). It is this technique which allows the use of twisted pair and flat cable, and such wires have high noise rejection.

The common strobe input allows the driver to operate normally or to be turned off into a high-impedance condition if power goes off as well as when logically strobed off. This allows all the other subsystems on the bus to operate even if one subsystem should have a power failure. With conventional outputs, the sub-

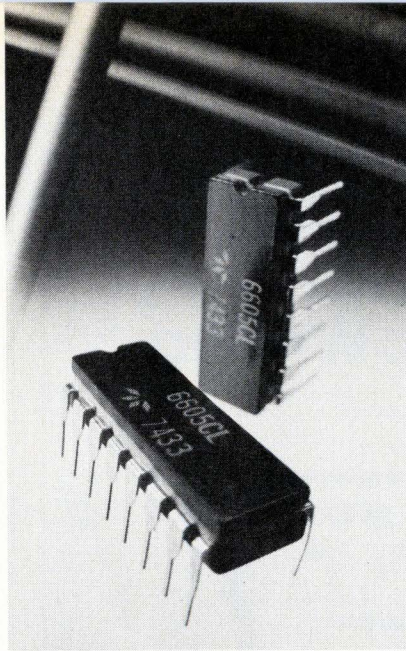

system losing power would pull all the bus lines low and render the system inoperative until some procedure restored the system.

Typical applications for the 6605 BDRs would be in the final stages of any type of digital subsystem. The subsystems could be within one complete system, such as a computer or a point-of-sale terminal; a primary system such as a computer mainframe and attached peripherals; or remote terminals.

The 6605 is available in volume quantities in two configurations—the J package (16-lead silicone DIP), and the L package (16-lead ceramic DIP). Price in 100-quantities is \$2.30 each.

Teledyne Semiconductor, 1300 Terra Bella Ave., Mountain View, Calif. 94040 [411]

Operational amplifier has slew rates to 70 V/ μ s

Slew rates to 70 volts per microsecond and bandwidths of 15 megahertz are features of the SG118/218/318 high-speed operational amplifiers. Typical input characteristics include 2 milliwatt offset voltage, 6-nanoampere offset current and 120-nA bias current. Voltage gain is typically 200,000, and supply voltage range is ± 5 volts to ± 20 V. Unity gain frequency compensation is provided internally. However, the device may be connected externally for uses requiring either feed-forward compensation (for slew rates greater than 150 V/ μ s) or over-compensation. Applications include a-d converters and sample-and-hold circuits. Prices range from \$2.60 to \$22.95 in 100-lots, depending on package.

Silicon General Inc., 2712 McGaw Ave., Irvine, Calif. 92705 [413]

Optically coupled isolator is rated at 25 kilovolts

An optically coupled isolator, with isolation voltage to 25 kilovolts, is called the OPI 120 and consists of

FINALLY A Battery Powered Chart Recorder Featuring COLD Electric Writing



- Instantaneous and uniform writing at any speed. No heat — No smoke — No ink.
- Operates more than 8 hours on a battery re-charge
- D. C. to more than 100 hz response
- Up to 999 chart speeds
- Lifetime guarantee on Stylus
- Two channels plus 1 marker, 50 MV full scale sensitivity
- Only 25 pounds complete



ASTRO-MED  **ATLAN-TOL INDUSTRIES INC.**

A DIVISION OF ATLAN-TOL INDUSTRIES, INC.
ATLAN-TOL INDUSTRIAL PARK
WEST WARWICK, RHODE ISLAND 02893
(401) 828-4000

New products

an npn silicon planar phototransistor coupled with a high-efficiency gallium arsenide infrared emitter mounted in a high-voltage plastic package. The device also is available in a photo-Darlington version. Minimum 25°C free-air isolation breakdown voltage of the OPI 120 is

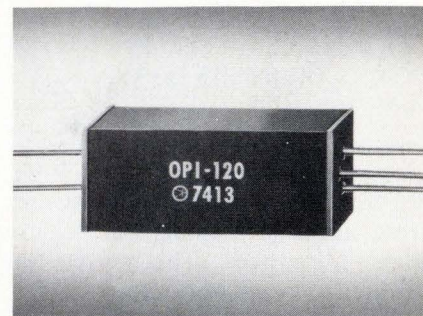

15 kv, which may be increased to 25 kv by special encapsulation. Typical current transfer ratio is 50% with an input of 10 milliamperes. The OPI 120 is priced at \$7.50 each in 100-lots.

Optron Inc., 1201 Tappan Circle, Carrollton, Texas 75006 [414]

Dual peripheral drivers handle 300 milliamperes

Called the LM3611 series, a family of dual peripheral drivers each contains a pair of TTL gates driving 300 milliamperes and 80-volt-output power transistors. This is said to be double the voltage capability of other monolithic peripheral drivers. The series consists of the LM3611 dual AND driver, the LM3612 dual NAND driver, the LM3613 dual OR driver, and the LM3614 dual NOR driver. Applications for the series are driving lamps, relays, solenoids, print-head hammers, or any inductive load where voltage spikes higher than 30 volts might be present. The series also has a slightly slower turn-on time. The added 100 nanoseconds or so in the device's internal delay means that less noise will be generated on the circuit card. And if the LM3611 is employed as a lamp driver, lamp life will be extended because of the

Problem solving... with Victoreen High Voltage Technology

1 UNORTHODOX CRT DRIVE

How did we meet ever-expanding requirements for increased bandwidth and lower power consumption, coupled with the availability of high-voltage zener-type diodes (Victoreen Corotrons)? With an unorthodox drive scheme for CRT's.

Basically, this scheme is a mirror-image of the conventional method. Instead of supplying the CRT anode with very high voltage, we ground the anode and supply a drive signal, riding at approximately -1800 volts, to the grid. The advantages? Being direct-coupled there are no reactive components to limit high-end frequency response or cause roll-off

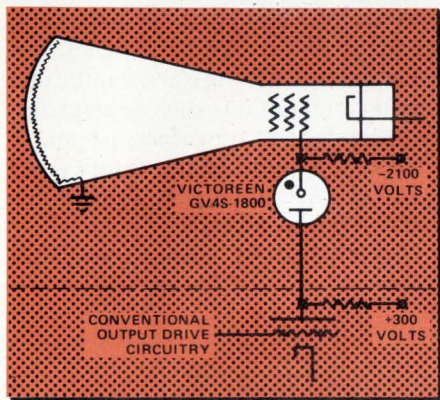

at the low end. Second, the face plate of the CRT does not build up static charges which can distort the display.

Even though the Corotron operates in the corona mode of discharge, it has no voltage jumps or jitters. Corotrons are not tied to "natural" operating voltages and are adjustable in manufacture from 350 to 30,000 volts. Corotrons also have a positive regulation curve eliminating possible relaxation oscillation.

2 FROG MUSCLES TO BRAIN WAVES

Colleges and universities, medical research laboratories and a number of R&D firms are faced daily with the need for controlled high-amplification of a wide variety of extremely low level signals. Such signals are derived from frog-muscle experiments, brain-wave measurements, cardiac research, avalanche-breakdown, currents in ionization chambers as well as from a range of constant-current sources.

The operational amplifier provides the amplification required because of theoretical infinite-gain characteristics. However, at full gain an op-amp tends to be unstable and go into oscillation; further, amplified signals are difficult to fully analyze if the gain is unknown.

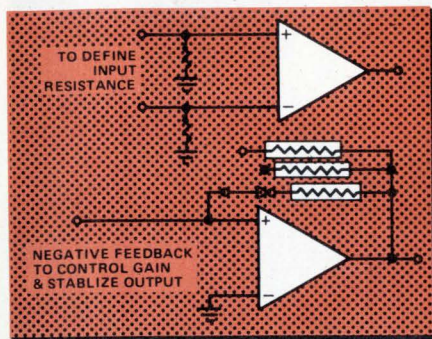

Victoreen MINI-MOX resistors are used widely to modify op-amp characteristics to: 1. Stabilize output and eliminate oscillation. 2. Define gain so measurements can be quantified. 3. Restrict bandwidth to the region of specific interest.

Smaller than a conventional resistor and compatible with a TO-3 can, MINI-MOX resistors are ideal for highly-stable, low-level, miniature electronic circuitry.

They typically have a voltage coefficient of -5 ppm/volt, full-load drift of less than 2% in 1000 hours, temperature coefficient of 100 ppm, and a Quatech noise of less than 1.5 μ V/volt at 20M ohms. They are available in values from 100K to 10,000M ohms in 1, 2, 5 and 10% tolerances.

3 A PROBE FOR HIGH POTENTIAL

Two Victoreen MAXI-MOX resistors used in series can serve as a probe in radar circuitry capable of measuring voltages up to 60,000 volts. The probe, compatible with a number of voltmeters of different manufacture, has both short- and long-term stability. Short-term stability assures negligible drift and fluctuation

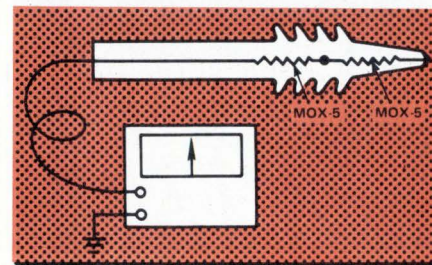

during measurement, while long-term stability maintains the original calibration accuracy of the probe.

Each MOX-5 resistor used in the probe has a maximum operating voltage of 37,500 volts with a power rating of 12½ watts. The voltage coefficient is 1 ppm/volt over the complete voltage range of the MOX-5, while the temperature coefficient is better than 300 ppm from

-55° to 125°C.

MAXI-MOX resistors have full-load drift less than 1% in 2000 hours of operation, and are available in tolerances of 1, 2, and 5% in values from 10K to 2,500M ohms. A silicone varnish conformal coating provides environmental protection while allowing a maximum hot-spot temperature of 220°C. In addition, it is compatible with commonly-used potting compounds.

4 SPARK GAPS SPARK INTEREST

Victoreen SGSP spark gaps normally protect electrical circuits from damage from transient voltage spikes; however, Optical Radiation Corporation, Azusa, Ca. uses them to ignite a Xenon lamp in a theatrical lamphouse to project motion pictures. Xenon lamps provide two

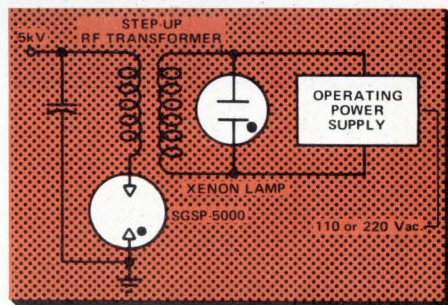

advantages; one, being very small and brilliant, light radiation is easier controlled; second, efficiency is higher, so smaller lamp-houses with greater output result. The design won the company an Academy Award in technical achievement.

In operation, the capacitor is charged until the SGSP-5000 breaks down. The stored energy is released through the transformer primary, producing a very high voltage pulse in the secondary which ignites the Xenon lamp. This provides an extremely reliable method of starting the lamp. Once ignited, operation is sustained by a lower-voltage line operated power supply.

**Victoreen Instrument Division
of VLN Corp.
10101 Woodland Avenue
Cleveland, Ohio 44104**



Variations of Light



National Semiconductors Limited offers a complete line of photoelectric devices, including:

photocells	photoelectric arrays
photodiodes	optoelectronic couplers
phototransistors	customized photoelectric devices



NATIONAL SEMICONDUCTORS LTD

331 Cornelia Street, Plattsburgh, N.Y. 12901 (518) 561-3160
 2150 Ward Street, Montreal 378, Quebec (514) 744-5507
 On the West Coast, call: Varigon. (213) 644-3611

Circle 158 on reader service card

Years ago we made a decision to let the other guys knock out all of the simple printed circuit boards they could make. We wanted the tough jobs.

Multilayer and two-sided PCs. Complex drilling, printing and plating.

And we wanted to do them better than anybody in the business. Since then, we've been doing

more of the hard work than anyone. And delivering it on time. With precision and economy.

We built a reputation on hard work. We're not about to take things easy now.

If you've got a tough job, call us at (213) 722-6810 collect. Or write Data Products Division, 6201 East Randolph Street, Los Angeles, California 90040.

We built a reputation on hard work.

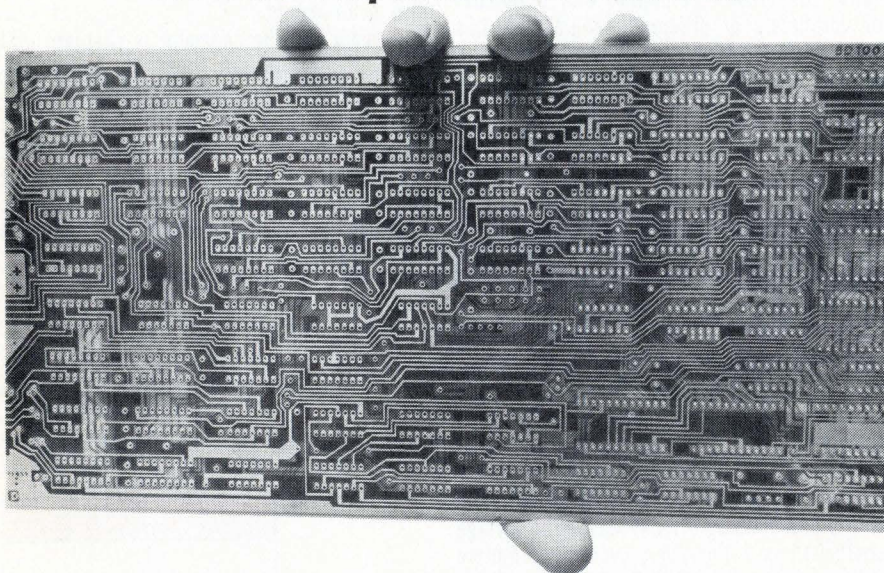

Lockheed Electronics—First In Complex PCs

15 YEARS OF LEADERSHIP IN ELECTRONICS. 1959-1974.

158 Circle 217 on reader service card

New products

softer rise-time. In quantities of 100, the units are price at \$1.90 each.

National Semiconductor Corp., 2900 Semiconductor Drive, Santa Clara, Calif. 95051

Npn transistor array

operates up to 500 MHz

A high-frequency linear-IC npn transistor array for low-power applications at frequencies up to 500 megahertz, designated CA 3127E, consists of five independent general-purpose silicon npn transistors constructed on a common monolithic substrate. Each of the completely isolated transistors has low 1/f noise and a gain-bandwidth product in excess of 1 gigahertz. Typical applications for the CA3127E include vhf amplifiers, vhf mixers, multifunction combinations such as rf/mixer/oscillator, i-f converters, i-f amplifiers, sense amplifiers, synthesizers, and cascade amplifiers. Price in lots of 1,000 is \$2.40 each

RCA, Solid State division, Box 3200, Somerville, N.J. 08876 [416]

IC op amp settles

in 600 nanoseconds

The model 3550 field-effect-transistor IC op amp has a unity-gain bandwidth of 20 megahertz and a guaranteed slew rate of 100 volts per microsecond, in addition to a maximum settling time of 600 nanoseconds. Unlike many other wideband fast-settling op amps, the

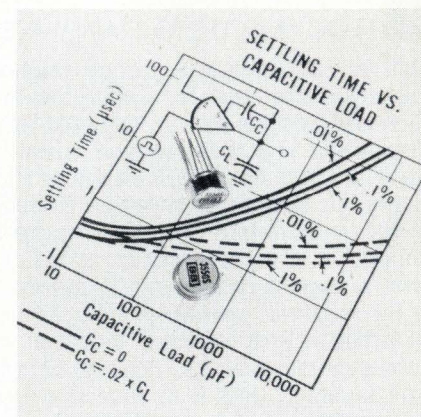

Electronics/September 19, 1974

New Coaxial Switches For ATE

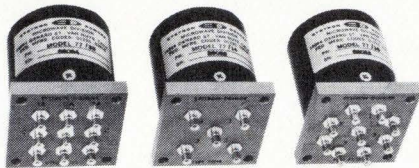

Systron-Donner's remotely programmable coaxial switches handle high-speed signal switching and multiplexing in 50 and 75 ohm systems. Choose from these 3 models:

Model Number	7714	7718	7732
Pole arrangement	1X4 (1P4T)	1X8 (1P8T)	3X2 (3P2T)
Rise time	<500ps	<1ns	<350ps
Transient aberrations (Pk - Pk, 1 ns step)	2%	2%	1%
Price	\$130	\$185	\$165

For full details, call your Scientific Devices office or contact S-D at 10 Systron Drive, Concord, CA 94518. For immediate details, call our Quick Reaction line (415) 682-6471 collect.



Circle 160 on reader service card

EFRATOM

CALIFORNIA, INC. Time and Frequency Systems

3303 Harbor Blvd., Suite E, Costa Mesa, Ca. 92626, USA Phone 714/556-1620

THE WORLD'S SMALLEST RUBIDIUM FREQUENCY STANDARDS Model FRK-L, Model FRK-H, Model FRT

Rb-Atomic Resonance
Controlled Oscillator
Excellent Stability
10 min. Warm up
5 Year Lamp/Cell Warranty

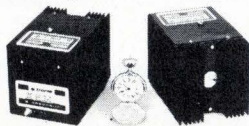

Model FRK-L \$3,480.00
Model FRK-H \$5,100.00
Model FRT \$6,780.00
O.E.M. Available

Model FRT, Atomic Frequency Standard
2 x 4 Output Frequencies, 10-5-1-0.1 MHz
Built-in Battery - Portable or Rackmounted

Replaces PRIMARY FREQUENCY STANDARD, when coupled to Model EFR and synchronized to National Standard Frequency, Absolute Frequency is few parts in 10^{12} .

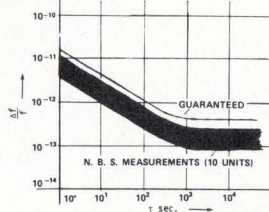
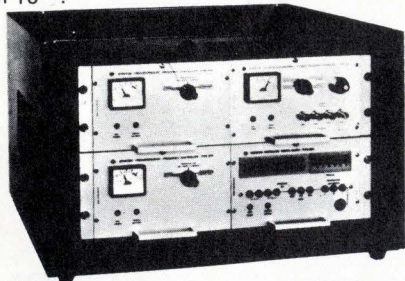

Model EFR Receiver-Controller
VLF/LF Frequency Coverage
Controls Frequency Standards
Time Synchronization Output for Clocks
Price \$1,975.00

Model EDU Digital Clock
BCD - Outputs - Time
Leap Second Insertion
Price \$1,790.00

FOR EUROPE: Efratom Elektronik GmbH, 8000 Muenchen 90, Langobardenstr. 7, West Germany. Ph. (089) 647138

160 Circle 218 on reader service card

New products

3550 has a fully differential input. This means that it can provide its transient performance in the inverting, noninverting, current-to-voltage, and difference configurations. Typical dc open loop gain is 100 dB, and input impedance is 10^{11} ohms. Price ranges from \$15 to \$26.

Burr-Brown Research Corp., International Airport Industrial Park, Tucson, Ariz. 85706 [418]

Up/down counter offers a 1.5-MHz clock rate at 50 pF

The model SIL4029A binary or BCD-decade presettable up/down counter can be used in counting/frequency synthesizers, in a-d and d-a conversion, for magnitude and sign generation, for difference counting, and for binary or decade up/down counting applications. The SIL4029A is designed so that multiple devices will operate in the parallel clock mode at a guaranteed clock rate of 1.5 megahertz with 50-picofarad loads. Output transition time is typically 70 nanoseconds. Price is \$3.80 in lots of 1,000

Siltek International Ltd., Bromont, Quebec, Canada [419]

Calculator circuit has independent memory

An 8-digit calculator circuit with independent memory, designated the MD50203N, is one of a series of MOS/LSI devices featuring four functions, percentage, automatic constant, independent memory, reciprocal calculation, exchange (display and constant register) key, floating-point operation and leading-zero blanking. Advantages such as single voltage, wide-tolerance power-supply operation, direct segment drive to LED displays, low power consumption and scan keyboard entry make the circuit suitable for handheld calculators. Price is \$6 in quantities of 1,000.

Mostek Corp., 1215 W. Crosby Rd., Carrollton, Texas [420]

Our new plants could change your new plans for transformers

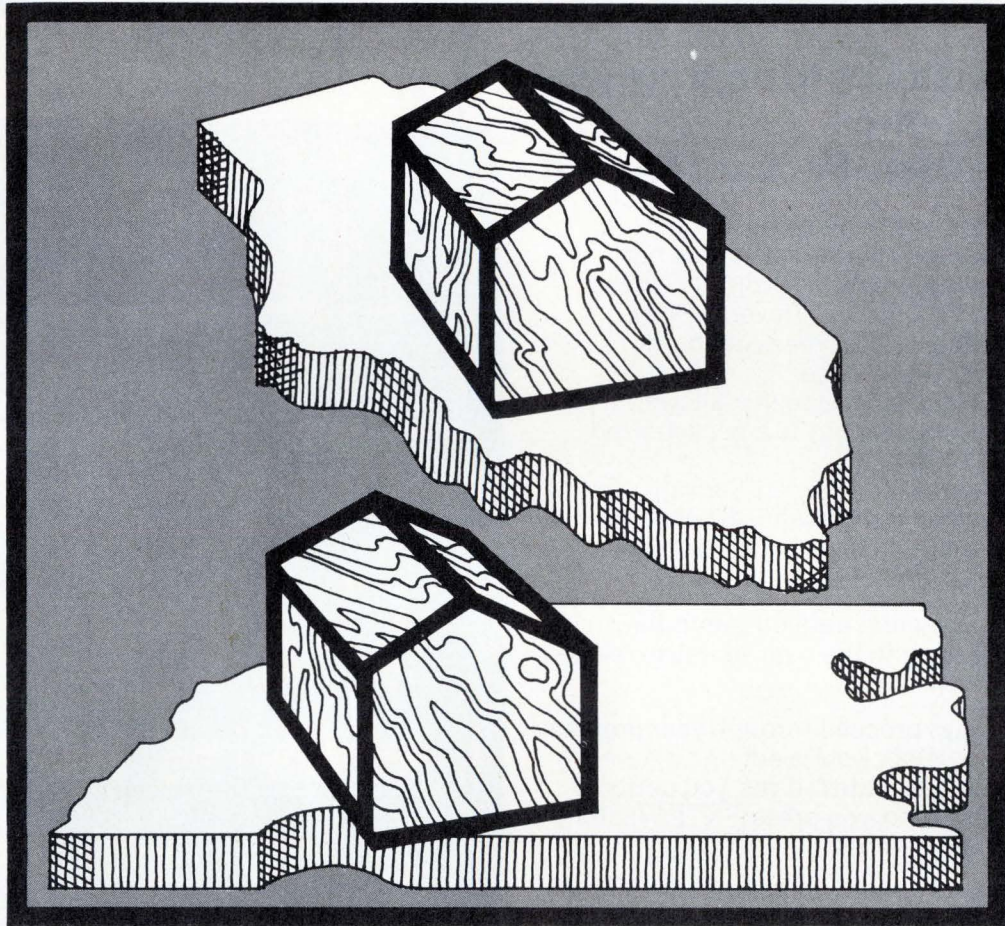

We're looking for unique requirements in power, constant voltage and inverter transformers. In quantities from 1,000 to 50,000.

Our new plants in North Carolina and Illinois will give us the manufacturing capability to produce almost any transformer you need—at very competitive quantity prices.

TRW/UTC deserves its excellent reputation for transformer design and manufacture. Chances are

our new facilities will position us as a prime supplier for your full line of magnetics. It's certainly worth checking into. But right now, if you're up against tough design problems, come to TRW/UTC. We're a major production house with a lot of design capability we're willing to turn loose on your problems. Call or write TRW/UTC Transformers, an Electronic Components Division of TRW, Inc., 150 Varick Street, New York, N.Y. 10013. Tel: (212) 255-3500.

TRW® **UTC TRANSFORMERS**

ENTER ↑

This is your key to unprecedented calculating power.

Only Hewlett-Packard offers it.

In 1928 a Polish mathematician, Dr. Jan Lukasiewicz, invented a parenthesis-free but unambiguous language. As it's evolved over the years it's come to be known as Reverse Polish Notation (RPN), and it's become a standard language of computer science.

Today, it's the one language that allows you to "speak" with total consistency to a pocket-sized calculator.

ENTER↑ is the key to Hewlett-Packard's patented RPN logic system because it enables you to load data into a 4-Register Operational Stack with the following consequences:

1. You can *a/ways* enter data the same way, i.e. from left to right, the natural way to read any expression.
2. You can *a/ways* proceed through your problem the same way. Once you've entered a number you ask: "Can I operate?" If yes, you perform the operation. If no, you press **ENTER↑** and key in the next number.
3. You can see *all* intermediate data anytime, so you can check the progress of your calculations *as you go*.
4. You almost never have to re-enter intermediate answers—a real time-saver, especially when your data have eight or nine digits each.
5. You don't have to think your problem all the way through beforehand to determine the best method of approach.
6. You can easily recover from errors since each operation is performed sequentially, immediately after pressing the appropriate key, and all data stored in the calculator can be easily reviewed.
7. You can communicate with your calculator efficiently, consistently and without ambiguity. You always proceed one way, no matter what the problem.

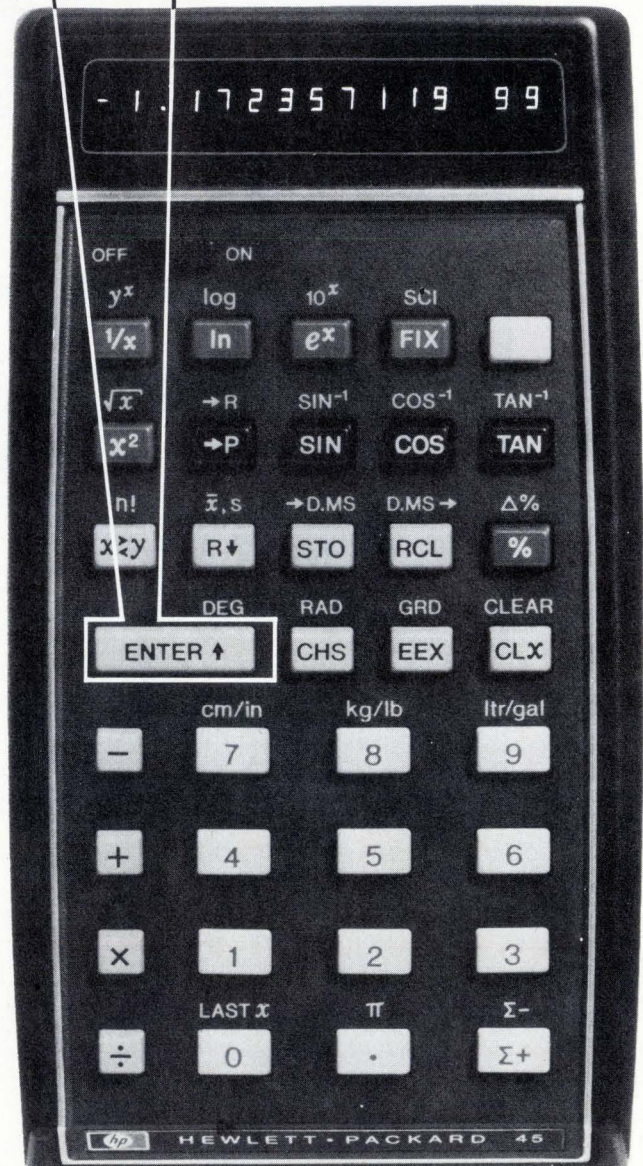

The HP-45 uses RPN.

That's one reason it's the most powerful pre-programmed pocket-sized scientific calculator. Here are 8 others:

1. It's pre-programmed to handle 44 arithmetic, trigonometric and logarithmic functions and data manipulation operations beyond the basic four (+, -, X, ÷).

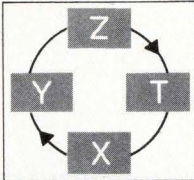
2.  It offers a 4-Register Operational Stack that saves intermediate answers and automatically retrieves them when they are required in the calculation.

3.  It lets you store up to nine separate constants in its nine Addressable Memory Registers.

4. It gives you a "Last X" Register for error correction or multiple operations on the same number. If you get stuck midway through a problem, you can use the "Last X" Register to unravel what you've done.

5.  It displays up to 10 significant digits in either fixed-decimal or scientific notation and automatically positions the decimal point throughout its 200-decade range.

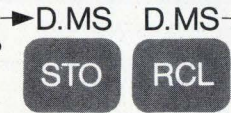
6.  **D.MS** **D.MS** → It converts angles from decimal degrees, radians or grads to degrees/minutes/seconds and back again.

7.  It converts polar coordinates to rectangular coordinates... or vice-versa. In seconds.

8.  Its Gold "Shift" Key doubles the functions of 24 keys which increases the HP-45's capability without increasing its size.

The HP-35 uses RPN too.

If the HP-45 is the world's most powerful pre-programmed pocket-sized scientific calculator, the HP-35 is runner-up. It handles 22 functions, has a 4-Register Stack, one Addressable Memory Register and also displays up to 10 digits in either fixed-decimal or scientific notation.

*Domestic U.S.A. prices, not including applicable state and local taxes.

New low prices.

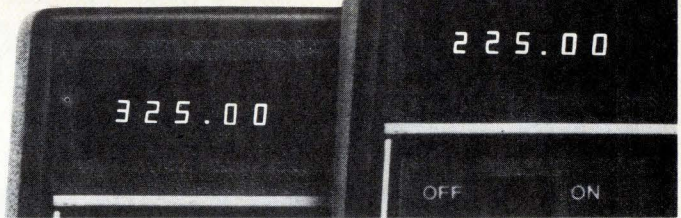

HP-45: \$325*

HP-35: \$225*

Now the exceptional value of these exceptional instruments is even more apparent, because we've cut their prices by \$70*. You can now own the world's most powerful pocket-sized pre-programmed scientific calculator, the HP-45, for only \$325*. The HP-35 now costs just \$225*.

Send for our booklet "ENTER vs. EQUALS."

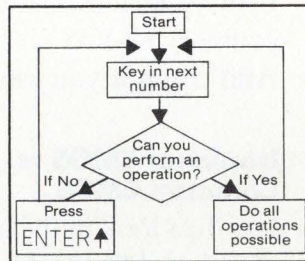

It demonstrates the superiority of Dr. Lukasiewicz' language by comparing it to other calculators' systems on a problem-by-problem basis, and it explains the algorithm shown above which lets you evaluate any expression on a calculator that uses RPN and an Operational Stack. This booklet is

must reading for anyone seriously interested in owning a powerful pocket-sized calculator.

The coupon gets you detailed specifications of either the HP-45 or the HP-35 plus the booklet.

Just check what you want and send it along. We'll get your information back to you by return mail.

Hewlett-Packard makes the most advanced pocket-sized computer calculators in the world.



Sales and service from 172 offices in 65 countries.
Dept. 214K, 19310 Pruneridge Ave., Cupertino, CA 95014. 614/20

Hewlett-Packard
Dept. 214K
19310 Pruneridge Avenue
Cupertino, CA 95014

Please send the booklet, "ENTER vs. EQUALS:"

- Detailed specifications on your HP-35.
- Detailed specifications on your HP-45.
- HP-35(s) at \$225* each plus state and local taxes. (Check enclosed.)
- HP-45(s) at \$325* each plus state and local taxes. (Check enclosed.)

Name _____

Company _____

Street _____

City _____ State _____ Zip _____

Isoplanar CMOS does what common CMOS can't. And now you can even get it in uncommon quantity.

Look, why settle for *common* CMOS when you can get all of the most popular functions in *Isoplanar* CMOS from Fairchild instead?

And not only that, but you can get them in quantity now.

Since our last ad on the subject, we've added 24 more Isoplanar CMOS device types for immediate delivery, with 19 more coming along before

the end of the year.

All together, that's 53 CMOS devices that leave ordinary CMOS far behind. And can put you way ahead.

Isoplanar CMOS vs. Common CMOS.

Just look at the advantages of Fairchild's Isoplanar CMOS and you'll see why it's something you should look into.

Basically, Isoplanar fabrication reduces chip area substantially. Which means Fairchild designers have room for full buffer circuitry and extra built-in performance with every CMOS device. Even SSI.

Fairchild Isoplanar CMOS Devices.

Available Now.

34001	Quad 2-Input NOR Gate
34002	Dual 4-Input NOR Gate
34011	Quad 2-Input NAND Gate
34012	Dual 4-Input NAND Gate
34013	Dual D Flip-Flop
34015	Dual 4-Stage Shift Register
34019	Quad 2-Input Multiplexer
34020	14-Stage Timer
34023	Triple 3-Input NAND Gate
34025	Triple 3-Input NOR Gate
34027	Dual JK Flip-Flop
34028	1-of-10 Decoder
34030	Quad Exclusive OR Gate
34040	12-Stage Timer
34042	Quad D Latch
34049	Hex Inverting Buffer
34050	Hex Non-Inverting Buffer
34051	8-Input Analog Multiplexer
34052	Differential 4-Input Analog Multiplexer
34069	Hex Inverter
34071	Quad 2-Input AND Gate
34077	Quad Exclusive NOR Gate
34081	Quad 2-Input OR Gate
34085	Dual 2-Input 2-Input AND/OR/Invert Gate
34086	Expandable 4-Wide 2-Input AND/OR/Invert Gate
34512	8-Input Multiplexer
340097	Hex 3-State Non-Inverting Buffer
340098	Hex 3-State Inverting Buffer
340160	4-Bit Decade Asynchronous Reset Counter

340161	4-Bit Binary Asynchronous Reset Counter
340162	4-Bit Decade Synchronous Reset Counter
340163	4-Bit Binary Synchronous Reset Counter
340194	4-Bit Right/Left Shift Register
340195	4-Bit Shift Register

Available 4th Quarter.

34014	8-Stage Parallel to Serial Shift Register
34016	Quad Bilateral Switch
34017	Decade Sequencer
34021	8-Stage Serial to Parallel Shift Register
34024	7-Stage Binary Counter
34029	4-Bit Binary/BCD Up/Down Counter
34035	4-Bit Parallel In/Out Shift Register
34068	8-Input NAND Gate
34099	8-Bit Addressable Latch
34104	TTL-to-High-Level CMOS Converter
34518	Dual 4-Bit Decade Counter
34527	BCD Rate Multiplier
34555	Dual 1-of-4 Decoder
34725	16 X 4 Bit RAM
340085	4-Bit Magnitude Comparator
340174	Hex D Flip-Flop
340175	Quad D Flip-Flop
340192	4-Bit Up/Down Synchronous Decade Counter
340193	4-Bit Up/Down Synchronous Binary Counter

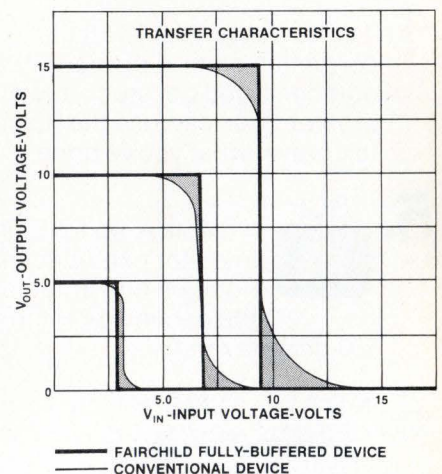

Because Fairchild devices are buffered for superior standardized performance, transfer characteristics are almost ideal.

And if you're a system designer, you'll really appreciate the benefits:

1. Highest guaranteed noise immunity in the industry.
2. Fully-standardized drive outputs for direct interface with low power TTL and low power Schottky TTL.
3. Pick your package: commercial grade plastic and military ceramic DIP is available now, commercial grade ceramic DIP in October.

New products

Data handling

Vacuum drive cuts price gap

Low-cost tape transport offers speeds from 25 to 75 inches a second

Vacuum-column magnetic-tape drives treat the tape more gently than the tension-arm transports, but the mechanical units have dominated the market because they are considerably less expensive. Now, Pertec Corp. is trying to close the price gap with its new model T9000 vacuum-column drive. The T9000, oriented toward the minicomputer market, is priced between \$3,200 and \$4,000.

The 10½-inch drive is available in several versions that have tape speeds from 25 to 75 inches per second and data transfer rates to 120,000 characters per second. The drive is compatible with both IBM and ANSI standards. It is also as compatible as possible with other Pertec drives; it is directly compatible with the company's tension-arm 75-in./s units, which are used for low-duty-cycle applications.

In developing the product, Pertec consulted its OEM customers, many of whom requested machines suitable for use in business offices. Peripherals marketing manager Ralph Gabai says that as a result, particular attention was paid to suppression of noise so that the drives are among the quietest on the market. This was possible partly through the use of a single short, wide, vacuum column, which requires less vacuum pressure than dual narrow columns. The vacuum blower turns at 8,000 to 9,000 revolutions per minute, rather than the standard 12,000 to 13,000 rpm. This also reduces power consumption and leads to longer belt life.

The air also creates a positive pressure in the tape compartment, which prevents pulling tape con-

taminants into the drive from an office environment. Gabai says this greatly reduces the drive's susceptibility to data errors. In addition, the familiar "twitching" of the reels in standby has been eliminated. As in all Pertec transports, the system permits editing so that users can selectively update prerecorded tapes.

For easy servicing, the panel and chassis swing out, and the motors and vacuum pumps are mounted on the chassis, rather than back in a cabinet. The drive can be serviced without extenders for circuit boards. Many parts are compatible with Pertec's tension-arm machines.

Standard configurations of the T9000 are seven- and nine-track NRZI, nine-track phase-encoding, and optional electronically switched nine-track NRZI/phase-encoding. Small quantities of the tape transport are available now.

Pertec Corp., 9600 Irondale Ave., Chatsworth, Calif. 91311 [361]

BCD interface built for calculator-controlled systems

A BCD interface that provides calculator control over storage readers, meters, counters and multichannel analyzers is designated the model 152. It provides the means to configure a complete system for data-acquisition, control, stimulus of programmable instruments, data-logging, or process control. The 152, for use with the Tektronix model 31 and 21 programmable calculators, provides direct parallel access to the display register and to the internal memory. The peripheral presents the data to the 152 interface in bit-parallel, digital-parallel format. The 152 then transfers the data to the calculator



4. Propagation delay that is less dependent on loading, for increased system speeds.

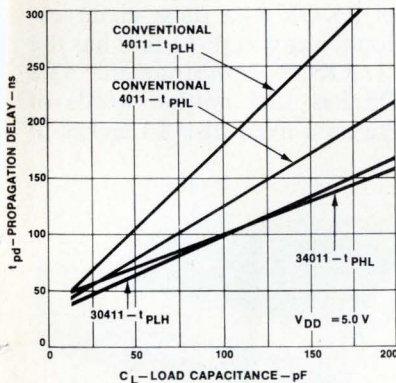

Fairchild's buffered CMOS gate has propagation delays which exhibit balanced T_{PLH} and T_{PHL} times and are less sensitive to load capacitance.

And the best part is, Fairchild's Isoplanar CMOS can replace any other 4000 series CMOS pin-for-pin.

So if you need production quantities of CMOS at competitive prices, call your Fairchild Distributor or Representative.

He's got all the facts on the kind of CMOS you need. Now.

**MADE IN
FAIRCHILD**

Microconductor Components Group, Fairchild Camera Instrument Corp., 464 Ellis St., Mountain View, CA 94040. Telephone (415) 962-5011. TWX: 910-379-6435.

Instant pulse

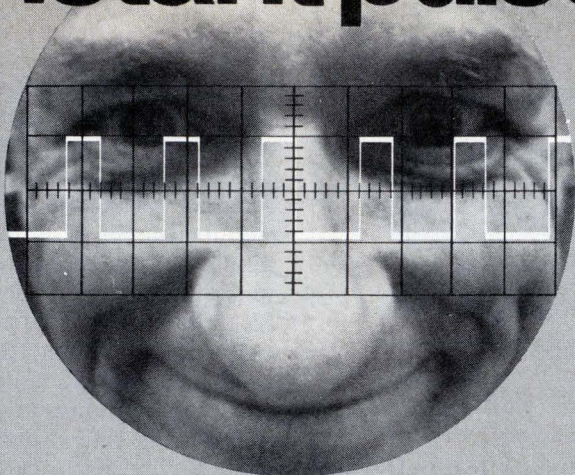

Interstate Pulse Generators have Constant Duty Cycle

Engineers are always surprised when they select the Constant Duty Cycle mode and adjust the width control on an Interstate Series 20 Pulse Generator — they get an instant pulse. It's "countdown-free," too.

For the whole story on Interstate's Instant Pulsers, call John Norburg collect. He'll send you Interstate's Series 20 Pulse Generator catalog — instantly.



Phone (714) 772-2811

Dept. 7000, Box 3117, Anaheim, California 92803
TWX U.S.A. 910-591-1197 TELEX U.S.A. 655443 & 655419.

Circle 166 on reader service card

Look to Ballantine for TRUE RMS Voltmeters



- True RMS • Battery Option
- 100 μ V to 300 V
- 2 Hz to 20 MHz (Usable to 50 MHz)
- 1% Mid-Range Accuracy
- Fast Response
- Fully Overload Protected

From \$665



Ballantine Laboratories, Inc.
P.O. Box 97, Boonton, New Jersey 07005
201-335-0900, TWX 710-987-8380

166 Circle 219 on reader service card

New products

in bit-parallel, digit-serial format. When the model 31 calculator is in the direct-memory-access mode, data can be transferred at 15,000 samples per second. Price is \$1,150 Tektronix Inc., P.O. Box 500, Beaverton, Ore. 97005 [363]

Moving-head disk drive gives 35-millisecond access

The Data Miser model DMO5 moving-head disk drive, which can replace the Digital Equipment Corp. model RKO5, is a daisy-chain expansion for any PDP-11 that has the RK11/RKO5 combination. The DMO5 has 1.25 million words of storage on a fixed disk 14 inches in

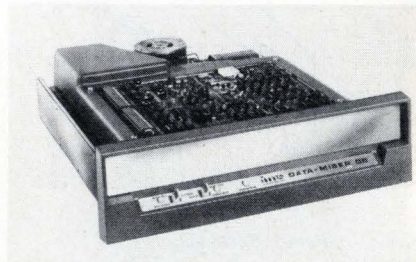

diameter. Using a head-positioning motor, the unit provides an average access time of 35 milliseconds, and track-to-track positioning time is 10 ms. The complete interface of the drive is on a 10-by-10-in. board. International Memory Systems, 14609 Scottsdale Rd., Scottsdale, Ariz. [364]

Arithmetic logic unit upgrades mini's capability

A high-speed arithmetic logic unit from Interdata is said to improve performance of the company's model 7/16 minicomputer. The ALU provides hardware floating point, signed multiply/divide, list-processing, and privileged instruction-detection. In addition, it improves all standard execution times by one third or more, the company says. Priced at \$4,900, the unit has a register-to-register load time of 0.75 microsecond, compared with an ex-

Electronics/September 19, 1974

MONO-KAP™

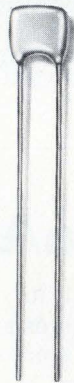

**RADIAL LEADED
MONOLITHIC CAPACITOR**

Underneath its epoxy coating, it's got a chip for a heart — a USCC/Centralab ceramic chip capacitor, 100% monolithic construction. Solid reliability for business machines, computer and communications use; rugged enough to meet mil-spec requirements yet priced for commercial applications.

Capacitance from 4.7 pF to 10 Mfd, working voltages 50 to 200 VDC and a variety of dielectric characteristics.

Best of all — AVAILABLE. USCC has recently improved chip capacitor deliveries . . . now radial leaded

Mono-Kaps are available in as little as 12 weeks for non-stock items.

Remember. USCC/Centralab or your local Centralab industrial distributor.

We deliver.



USCC/Centralab

Electronics Division ■ Globe-Union, Inc.



2151 North Lincoln Street ■ Burbank, California 91504
(213) 843-4222 ■ TWX: 910-498-2222

Countdown Free!

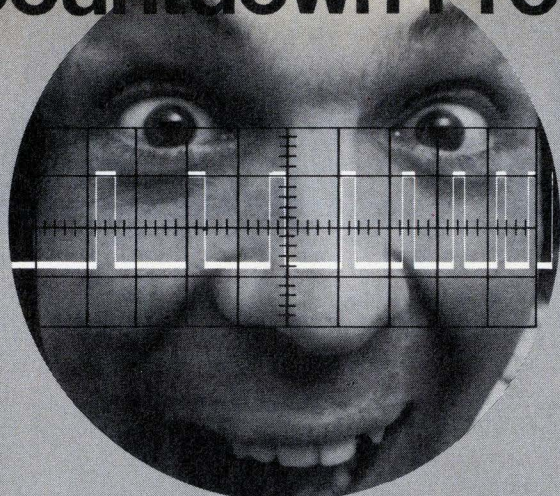

Interstate Pulse Generators have Constant Duty Cycle

Interstate's exclusive Constant Duty Cycle mode automatically controls pulse width as a percentage of the period, so when you're varying the rep rate, the generator can't possibly skip a pulse or two and give you an invalid output.

Constant Duty Cycle is only one of many innovative Series 20 features you've never seen in a pulse generator before. Call John Norburg collect and he'll send you the new Interstate Series 20 Pulse Generator catalog—it's free, too!

Phone (714) 772-2811



Dept. 7000, Box 3117, Anaheim, California 92803
TWX U.S.A. 910-591-1197 TELEX U.S.A. 655443 & 655419.

Circle 168 on reader service card

EPITAXIAL n/n^+ GaAs

Epitaxial n/n^+ GaAs—prepared especially for microwave and other applications—features a doping density ranging from 10^{16} to 10^{17} cm^{-3} for the n -type epi-layer with a typical layer thickness ranging from 0.2μ to $3\mu\text{m}$. Either epi-layer grown n -type or semi-insulating Chromium-doped substrates are available. The higher electron mobility and operating temperature together with the limited carrier velocity of the GaAs makes the material superior to Silicon for usage in FET's, Schottky Barrier FET's and IMPATT and Gunn Diodes. Other Epitaxial III-V and II-VI Compounds also available.

**FOR TECHNICAL INFORMATION ...
CALL OR WRITE
Dr. Dieter H. Pommerrenig**



PHOTOELECTRONIC MATERIALS CORPORATION
30 SOUTH QUAKER LANE • ALEXANDRIA, VIRGINIA 22314
(703) 751-9008

168 Circle 220 on reader service card

New products

ecution time of $1.5\mu\text{s}$ for the processor without the new option. Unit price of the ALU is \$4,900.

Interdata Inc., 2 Crescent Place, Oceanport, N.J. 07757 [365]

Data-entry system uses
disks for temporary storage

A shared-processor data-entry system with three to eight video keystations and hard-copy teleprinter output rents for \$500 a month on a two-year contract or sells for \$20,000. The system, designated



CMC 3, has disk capacity for temporary storage of 6,000 112-character records. Through modification, disk-storage capacity can be tripled to 18,000 records. Hardware consists of a supervisory console, a teleprinter, and three video keystations that display full 112-character records as they are keyed. The supervisory console houses the system's computer, magnetic-disk unit, control electronics, and a choice of either a seven-track, 550/800-bits/inch or a 9-track, 800-b/in. magnetic-tape unit.

Computer Machinery Corp., 2500 Walnut Ave. Marina del Rey, Calif. 90291 [366]

Computer system designed
for rugged environments

For airborne, shipboard, and truck-mounted applications, a ruggedized computer, priced at \$19,500, with-

Electronics/September 19, 1974



Chances are you own a continuously tunable electronic filter. So by now you probably realize that continuously tunable filters are low performance instruments with, at best, 5% accuracy. And with poor reproducibility of settings, poor frequency accuracy and poor phase drift characteristics. And although continuously tunable filters provide infinite resolution, most users find infinite resolution neither important nor desirable unless there's corresponding accuracy.

But all this isn't why we say "junk it."

WHAT YOU SET, ISN'T WHAT YOU GET.

Take a look at the graph. As you can see, the front panel filter settings don't tell you the -3dB cutoff frequencies, the bandwidth, the noise bandwidth, and the center frequency. Or the insertion loss. You have to measure them — a time consuming, costly procedure.

THERE'S A BETTER WAY.

Ithaco offers two types of filters with switch selectable frequency settings. One type has 3 decimal digit frequency resolution for the user who not only needs resolution but also wants to know where he is without measuring.

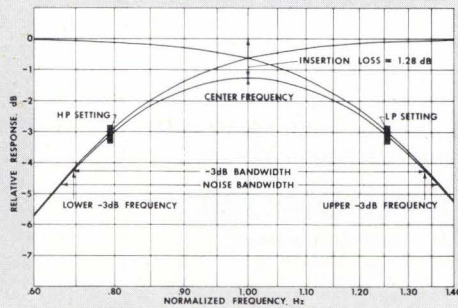

Normalized gain, attenuation, phase, and pulse response curves are printed on top of the filter. The other type uses the internationally accepted 1/10 decade [1/3 octave] frequency step — so you can operate with octave, decade and other convenient band pass settings, and still have sufficient frequency resolution for general lab and data acquisition applications. These filters have all the information shown on the graph printed on top — for all filter settings. And that's why we say "take your laboratory filter and junk it."

MORE NAILS IN YOUR FILTER'S COFFIN . . .

Standard accuracy of all Ithaco filters is $\pm 1\%$ in frequency, $\pm 2^\circ$ in phase, and $\pm .1\text{dB}$ insertion loss — all at least twice as good as the best the competition can offer. Plus, output drift is an order of magnitude lower than the competition. And self-noise is minimal. Best of all, Ithaco filters are competitively priced.

NOW THAT YOU NEED A NEW FILTER . . .

Write to Ithaco Inc., 735 W. Clinton Street, Ithaca, N. Y. 14850. Or, if you can't wait [we understand] call 607-272-7640, TWX 510-255-9307.

Take your laboratory filter and junk it.

ITHACO

Circle 169 on reader service card

**HANDLE
WITH CARE**
EASE

Diacon introduces an adjustable environmental Handler that can store and sort up to 300

semi-conductor packages simultaneously while operating over a temperature range of -73°C to 150°C . It adapts to any shape feeding stick and can adjust to fit any size package.

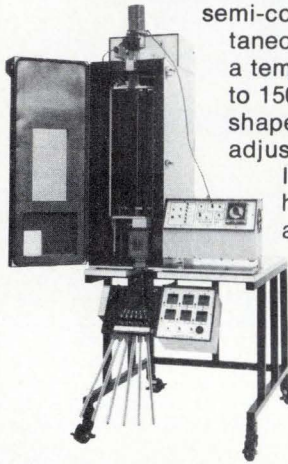

It can handle 4200 parts/hour with zero test time and is compatible with all testers. With few moving parts, it is highly reliable. For easy handling of your packages, contact:

DIACON, INC.

4812 Kearny Mesa Road
San Diego, California 92111
(714) 279-6992

Circle 170 on reader service card

**The Gould 6000
Data Acquisition System:
128 fully floating and integrating inputs,
scans to 200 points/sec.**

The portable and rugged Gould 6000 analog to digital data logger-reader is the best way to monitor and precisely record low frequency data. It accepts both analog and digital input signals, converts the data to digital form, displays the data for real-time monitoring and stores up to 500,000 readings on a 3M $\frac{1}{4}$ " computer grade mag-tape. It offers high noise rejection, high input impedance, programmable gain and much more.

Write Gould Inc., Instrument Systems Division, 3631 Perkins Ave., Cleveland, Ohio 44114. Or Kouterveldstraat Z/N, B-1920 Diegem, Belgium.



GOULD

170 Circle 221 on reader service card

New products

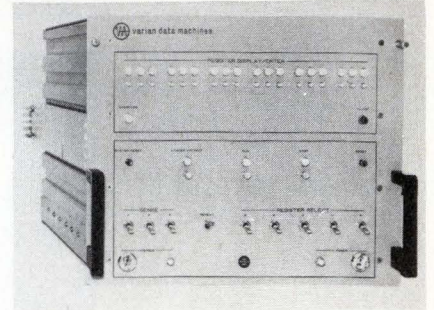

stands vibration, shock, electromagnetic interference, humidity, and temperature extremes that would destroy a commercial-grade computer. The system, called the model R620/L-100, includes hermetically sealed integrated circuits and conformally coated circuit-card assemblies. Its mechanical construction allows the R620/L-100 to operate while undergoing repeated hammer blows on all three axes. Available in 16- or 18-bit versions, the unit has a 950-nanosecond cycle time, more than 100 basic commands, six addressing modes, memory capacity of 32,000 words, and nine hardware registers.

Varian Data Machines, 2722 Michelson Dr., P.O. Box E, Irvine, Calif. 92664 [367]

**Remote-batch systems
offer variety of modes**

A family of intelligent remote-batch systems for use in a wide range of distributed-processing applications is compatible with IBM 2780 and 3780 data-transmission terminals. The systems support a variety of peripherals, including readers that handle 300 to 600 cards per minute,



Electronics/September 19, 1974

HERMES LOOP ANTENNA

THREE SAMPLE SITES
ON THE NORTH AMERICAN
CONTINENT —

DIFFERENT LATITUDES
DIFFERENT CLIMATE

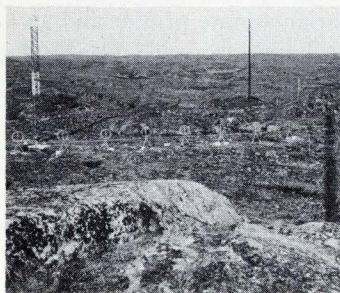

FROBISHER BAY, CANADA



MARSHFIELD, MASS.

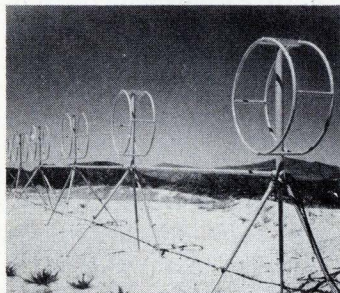

NEAR SAN DIEGO, CALIF.

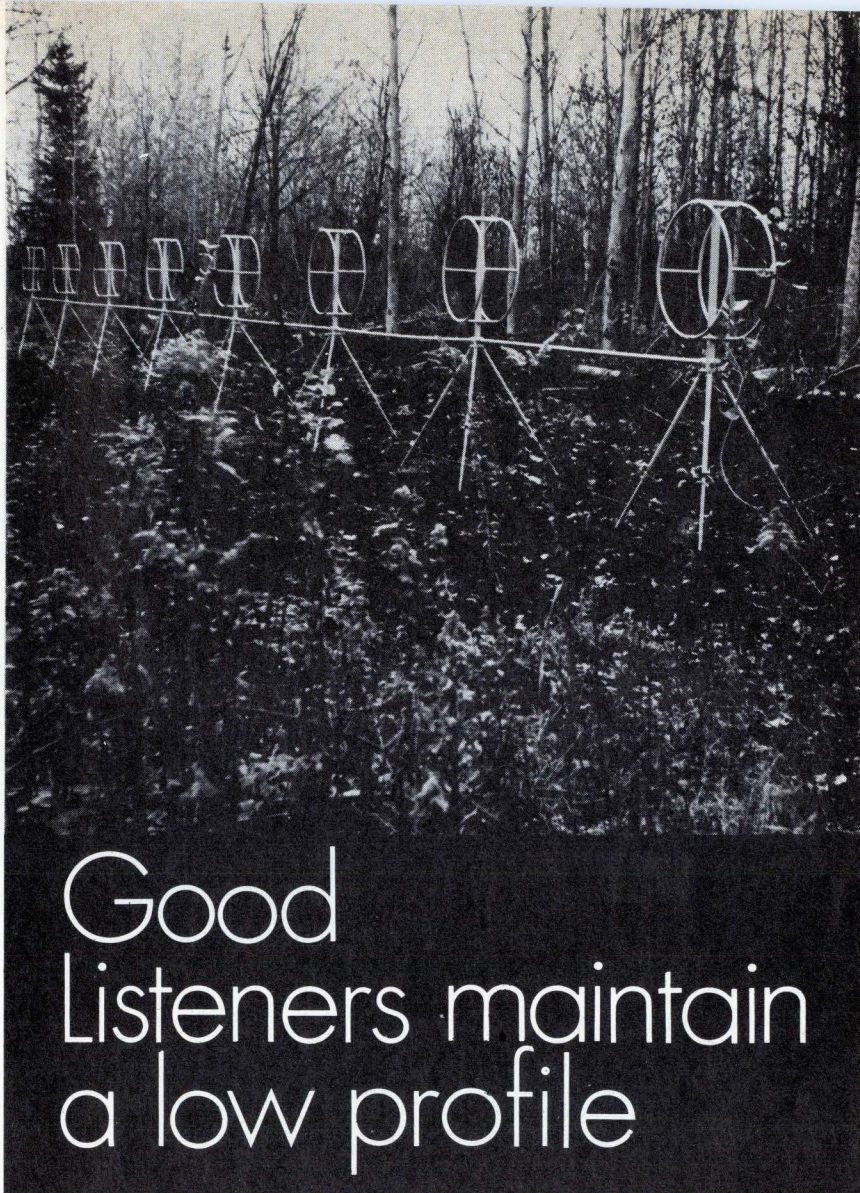

Good Listeners maintain a low profile

Even in the solitude of the forest depths, from rooftops, arctic tundra, swamps to sweltering tropics, 'neath snow, sand or ice, the Hermes Loop antenna keeps an ear to the sky. The amazing aperiodic antenna does away with vast log periodic and rhombic arrays - those towering antenna farms.

Excellent directional characteristics in rosette configuration, the Hermes loop antenna provides an omnidirectional broadband receiving array in space merely 1/100th that of the traditional antenna farm. More than 53 government agencies around the world have pressed the loop antenna into service.

A new, even more compact version is available. Only Hermes Electronics makes it.

**2-32MHz
BROADBAND**

ASK US Send for our Brochure

Hermes Electronics Limited
Suite 315
2020 F Street NW
Washington, DC 20006 USA
202-296 2978
TWX 710 822 1106



automatic second shift

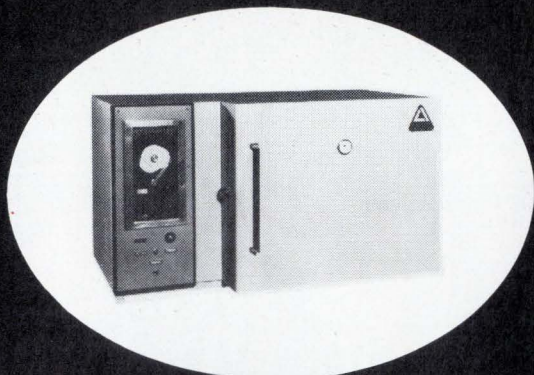

For the lab that's tight with the buck, our economical low-cost automatic helpers solve your around-the-clock labor problems. All Associated chambers are automatic with the addition of one of our many programmers.

For information on the broadest standard line of environmental simulation equipment available contact:



Associated Environmental Systems
Division of Craig Systems Corp.
360 Merrimack Street
Lawrence, Mass. 01842
617-683-9501

Circle 172 on readerservice card

A CAMBION® Double "QQ" Product Line

Unwind with Cambion's complete line of micro-miniature coils.

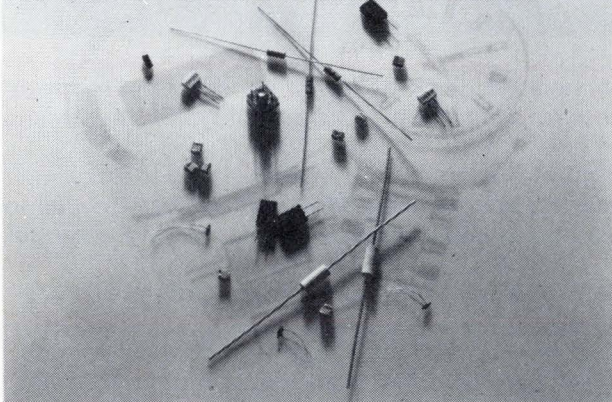

Cambion coils with repeated known design characteristics have done it again. It's the new micro-miniature series of thick-film, bondable, fixed inductors in a wide range of 0.1 to 100,000uH with immediate availability. These electronically shielded coils offer higher Q values than ever before. And with Cambion's complete engineering capabilities and manufacturing facilities coils are custom wound to fit your specifications. For complete facts on the micro-miniature series write for our Catalog 501. Cambridge Thermionic Corporation, 445 Concord Avenue, Cambridge, Massachusetts 02167.

Standardise on

CAMBION®

The Guaranteed Electronic Components

172 Circle 222 on reader service card

New products

printers operating at 300 to 1,800 lines per minute, and either a diskette or 2.5-million-byte disk drive for program loading. A 1,152-character video console is provided for operator control, as well as monitoring of system and job status. Users may select from among a variety of operating modes through keyboard entries. The system accommodates a maximum transmission speed of 9,600 characters per second on binary synchronous networks. A typical diskette-based system with a 300-cards-per-minute reader, a 300-lines-per-minute printer and a video control console rents for \$865 per month on a one-year lease.

Four-Phase Systems Inc 19333 Vallco Pkwy., Cupertino, Calif. 95014 [368]

Reader designed for
credit-card systems

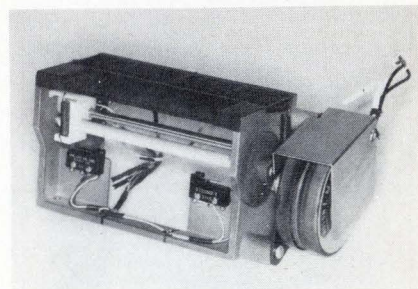

Intended for OEM applications, a magnetic-stripe reader can encode or read data from credit cards in accordance with ANSI Standard X4.16-1973 and it meets industry specifications. The reader mechanism uses a multithread lead screw, precision-ground gears, and a synchronous motor for consistent speed of operation. The magnetic head is mounted on a double-axis gimbal that provides positive tracking of data on damaged or warped credit cards. Interbit jitter is less than 1.5%. The reader is available with an electronic output that converts the magnetic encoding to a clocked digital, bit-serial signal. Price is \$90; the electronics is available for an additional \$45 in lots of 500.

Elcom Industries Inc. 10277 Bach Blvd., St. Louis, Mo. 63132 [370]

Electronics/September 19, 1974

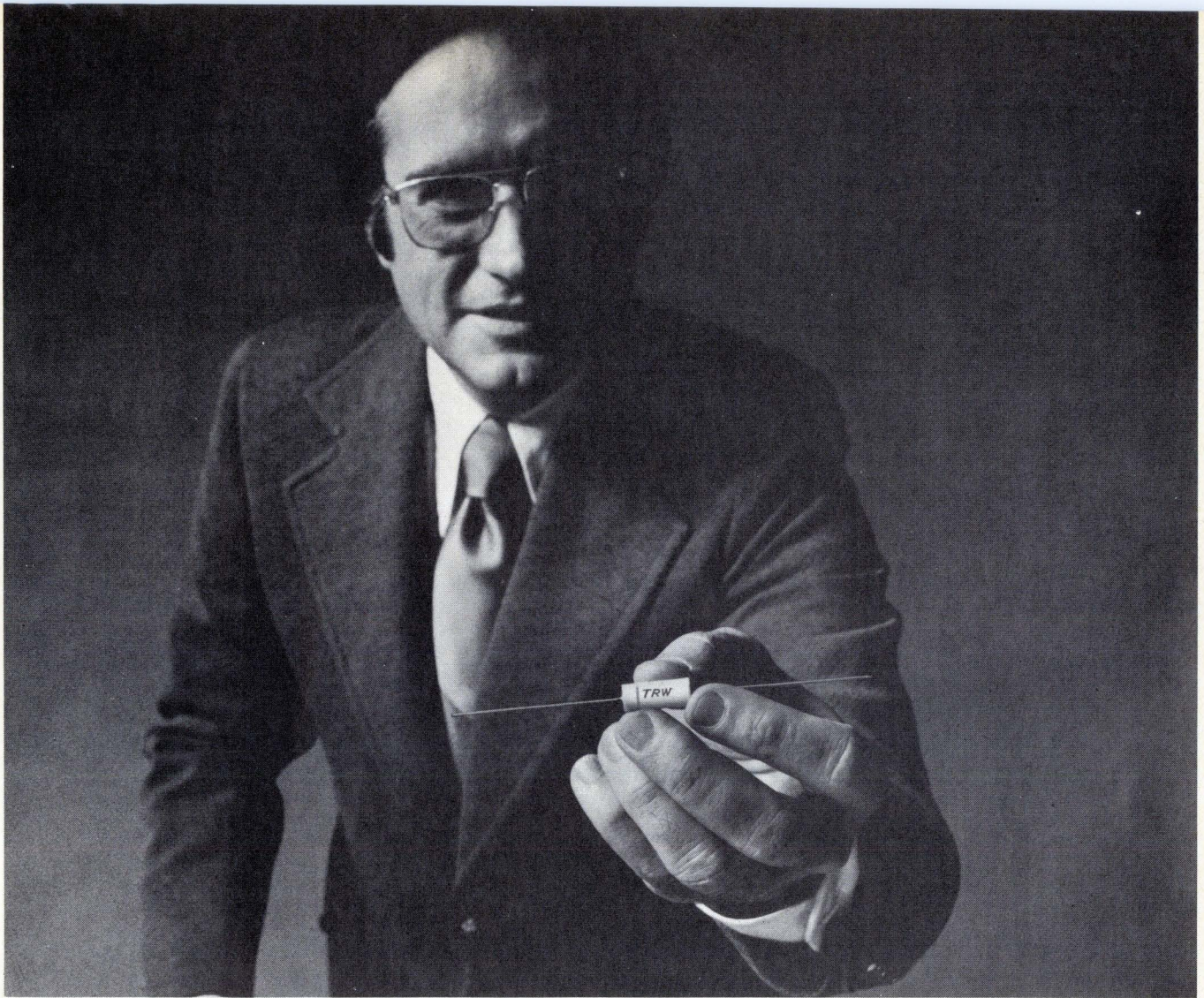

Tell you what we're not going to do.

Sure, we know *how* to make cheaper capacitors. But not with "TRW" stamped on them. No way. Because we figure you can't make quality capacitors and me-too capacitors under the same roof. Not without one operation eventually goofing the other one up.

So if it's marked "TRW," you *know* you're getting the top technology in wound—both metallized and film foil—and solid tantalum capacitors.

You're also getting a pipeline to some of the best minds in capacitor R&D, design, QC, and application engineering—ready to help you with *any* capacitance problem. From TV to aerospace.

All this will cost you a little more per capacitor. In return, it can help *your* product earn a reputation for "no headaches, no surprises." What better edge in today's marketplace?

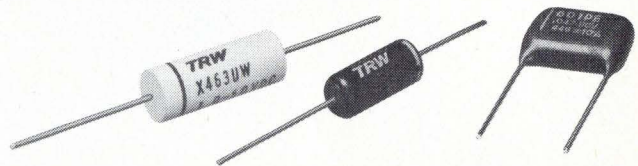

TRW Capacitors, an Electronic Components Division of TRW, Inc., Box 1000, Ogallala, Nebraska 69153.

TRW[®] CAPACITORS

Fight the increase in energy costs!

Use UHF power tetrodes in your 20-kW/470-860 MHz TV transmitters.

The new generation of THOMSON-CSF UHF tetrodes, featuring unique vapor-phase anode cooling (**Hypervapotron***) and pyrolytic graphite grids (**Pyroblot***), offer low-voltage operation, small size and light weight, and unparalleled linearity and efficiency.

**Save electrical energy
Save capital expenditures
Save operating costs.**

* THOMSON-CSF's registered trademark and patents



THOMSON-CSF

THOMSON-CSF ELECTRON TUBES, INC / 750 BLOOMFIELD AVENUE CLIFTON NJ 07015 / TEL. (201) 779 1004 / TWX : 710 989 7149

France - THOMSON-CSF Groupement Tubes Electroniques / 8, rue Chasseloup-Laubat / 75737 PARIS CEDEX 15 / Tél. (1) 566 70 04

Germany - THOMSON-CSF Elektronenröhren GmbH / Am Leonhardsbrunn 10 / 6 FRANKFURT/MAIN / Tel. (0611) 70 20 99

Italy - THOMSON-CSF Tubi Elettronici SRL / Viale degli Ammiragli 71 / ROMA / Tel. (6) 38 14 58

Japan - THOMSON-CSF Japan K.K. / Kyosho Building / 1-9-3, Hirakawa-cho / Chiyoda-ku / TOKYO 〒102 / Tel. (03) 264 6341

Sweden - THOMSON-CSF Elektronrör AB / Box 27080 / S 10251 STOCKHOLM 27 / Tel. (08) 22 58 15

United Kingdom - THOMSON-CSF Electronic Tubes Ltd / Bilton House / Uxbridge Road / Ealing / LONDON W 5 2TT / Tel. (01) 579 55 11 / Telex 26 659

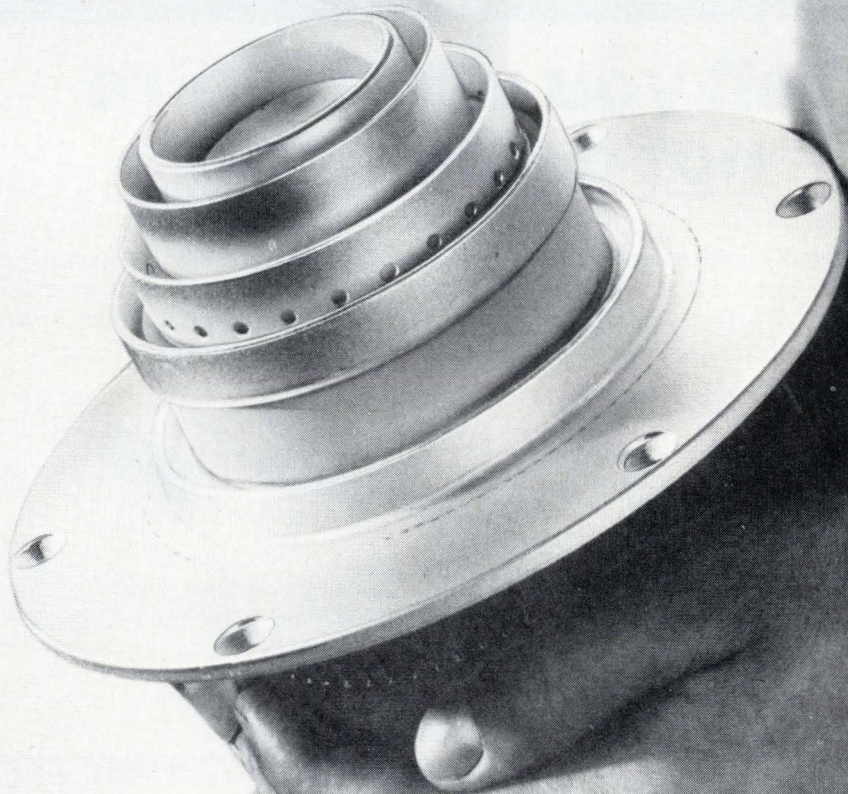

Circle 174 on readerservice card

New products

Packaging & production

Dry-etch step improved

Perforated cylinder in reaction chamber increases uniformity

A new development in the dry etching of semiconductor wafers is said to bring the dry-etch system up even with wet etching in terms of the uniformity of the etched channels. At least until now, uniformity has been the achilles heel of dry etching. Conversely, it has been the main argument for wet etching in the face of a number of drawbacks. In wet etching, density and etch rate are not always controllable or easily reproducible; the liquid etchant undercuts the channels, thereby limiting packing density; there is danger of over-etching because the etchant attacks metalized areas as well as the wafer material; and the process itself is rather messy.

Despite this, wet etching is often the method of choice because its uniformity error is within 1%, versus $\pm 15\%$ for dry etching. Now, with the introduction of the new technique by the LFE Corp., dry etching may offer the same degree of uniformity, the company says.

The heart of the technique is a perforated cylinder made of carbon-steel or nickel and with a transparency of at least 25%. The perforated cylinder is inserted into the center of a reaction chamber, within which the wafers are placed. Electrically charged particles are catalytically deactivated on the surface of the cylinder. In most dry-etch systems, an electrical field created by an inductive coil wrapped around the reaction chamber causes perturbations, disturbing these charged particles and resulting in problems with etch uniformity. With the new technique, the luminous zone is kept outside the cylinder; no charged particles enter it, and etch uniform-

ity is good, the company says.

At the same time, the cylinder acts as a filter, letting through neutral particles, since the $\frac{1}{8}$ -inch holes in the cylinder are bigger than the mean-free-path between collisions of the neutral particles in the plasma. When a neutral particle goes through a hole, it has a good chance of colliding with another neutral particle, so the motion of particles entering the cylinder is randomized to give a good distribution of neutrals and therefore good etch uniformity. It is the neutral particles which actually do the etching, so the etch rate is not affected by removal of the charged particles.

Temperature within the cylinder rises more slowly and the reaction temperature is lower than in most systems. With 350 watts of rf power, temperature within the reaction chamber is about 210°C in one minute and levels off at about 325°C in eight minutes. Within the cylinder, a temperature of about 112° is reached in one minute at 350 w, and levels off at about 250° in 15 minutes. This happens because there are no charged particles within the cylinder to recombine and liberate heat, and neutral particles, which rarely recombine, have a much lower energy content. Lowered temperature is especially important when dealing with field-effect devices, which are more affected by temperature changes than are bulk bipolar devices.

LFE claims that by using the new technique in a reaction chamber with 350 w of rf power and a subatmospheric pressure of 1.45 torr, it can remove anything from 100 angstroms of thermal silicon dioxide with 0.5% error of radial etch uniformity, to 11,000 angstroms with 1.2% error. Etch rate varies with the batch size; the rate lowers from one to 10 wafers and remains stable between 10 and 25 wafers. Wafers can range in size from 2 to 3 inches in diameter and anywhere from one to 25 wafers may be in an 8-inch cylinder.

Adir Jacobs, a senior staff scientist who developed the technique, thinks it will have a major impact

\$125

it's so easy to take . . .

You can replace your thermopile with a SBN PYROELECTRIC DETECTOR.

- BROADBAND RESPONSE—
UV to microwaves
- HIGH SENSITIVITY—
> to 125 V/W
- FAST RESPONSE—
better than 5ns
- NO CRYOGENICS—
operates from -40°C to 90°C
- RUGGED AND
NONHYGROSCOPIC

This package includes a sensing element plus a integral FET and fits a standard 9 pin miniature tube socket. Available from stock for only \$125.00.

Call us at 216/248-7400 with your IR detection and measurement problems.



HARSHAW

THE HARSHAW CHEMICAL COMPANY
DIVISION OF KEWANEE OIL COMPANY

Crystal & Electronic Products Department
6801 Cochran Road • Solon, Ohio 44139
(216) 248-7400

Circle 175 on reader service card

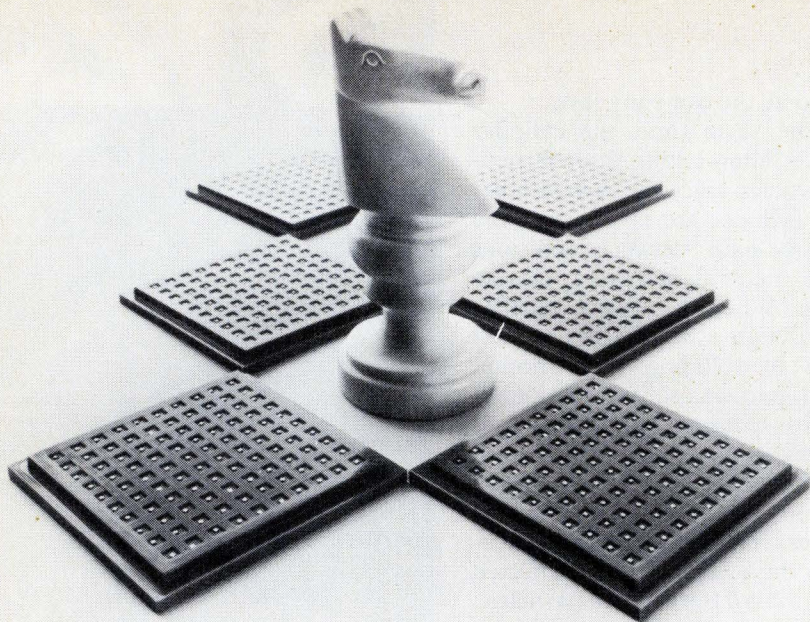

Our resistor chips: Your move.

30-MIL thin-film-NiCr Resistor-Chips.

RESISTANCE RANGE: 10Ω to 510KΩ.
TEMPCO: 0 to +50 PPM/°C.
TRACKING MATCH: ±1 PPM/°C.
POWER DISSIPATION: 250 mW. NOISE: 0.01μV/Vmax.
RESISTANCE TOLERANCE: ±1 and ±5%
 (or tighter, by request).
TEMPERATURE: -55°C to +125°C.
MIL-STD-883 A or B. GLASS PASSIVATED.
CONFIGURATION: chips, wafers,
multi-chip trays, tube packs.

For Fast Action, Call:

In USA: (617) 272-1522 (or TWX 710-332-7584)
 In Europe: Hybrid Systems Europa GmbH, 61 Darmstadt,
 Luisenplatz 4, Germany Tel. 6151-291595 TELEX 841-419390

Hybrid Systems Corporation
 Burlington, Massachusetts 01803

Hybrid Systems
 CORPORATION

New products

on the market. He expects dry etching will be used routinely in production within five years. Besides giving good uniformity, he says, it removes the wafer from the actual ionization region so it can be used to etch MOS, as well as bipolar devices. And while the randomized motion of liquid etchants causes undercutting, the widely dispersed neutral particles in a dry-etch system enter channels head-on with no undercutting, making it possible to increase the packing density.

The cylinder is available as a retrofit for LFE dry-etch systems already in the field and will be a standard part on all new etch systems. As a retrofit, it will cost several hundred dollars, but it will not alter the price of new systems, which range from \$6,000 to \$20,000, depending on size and number of chambers and rf power. The cylinder is available in several sizes to fit varied reaction chambers, and can work at different pressures, powers, and etch rates. Delivery time is 30 days.

LFE Corp., 1601 Trapelo Rd., Waltham, Mass. 02154 [391]

Flat cable made with
 impedances of 50-125 ohms

Continuous lengths of up to 50 feet of flat conductor transmission line, with controlled impedance throughout the entire length, and terminating pads every 1/2 inch, are manufactured in 50- to 125-ohm

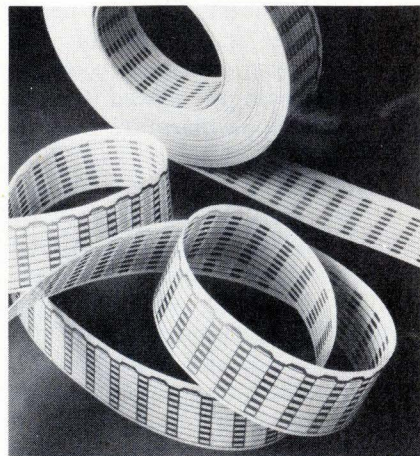

Buy our industry standard MV50's for all the standard reasons.

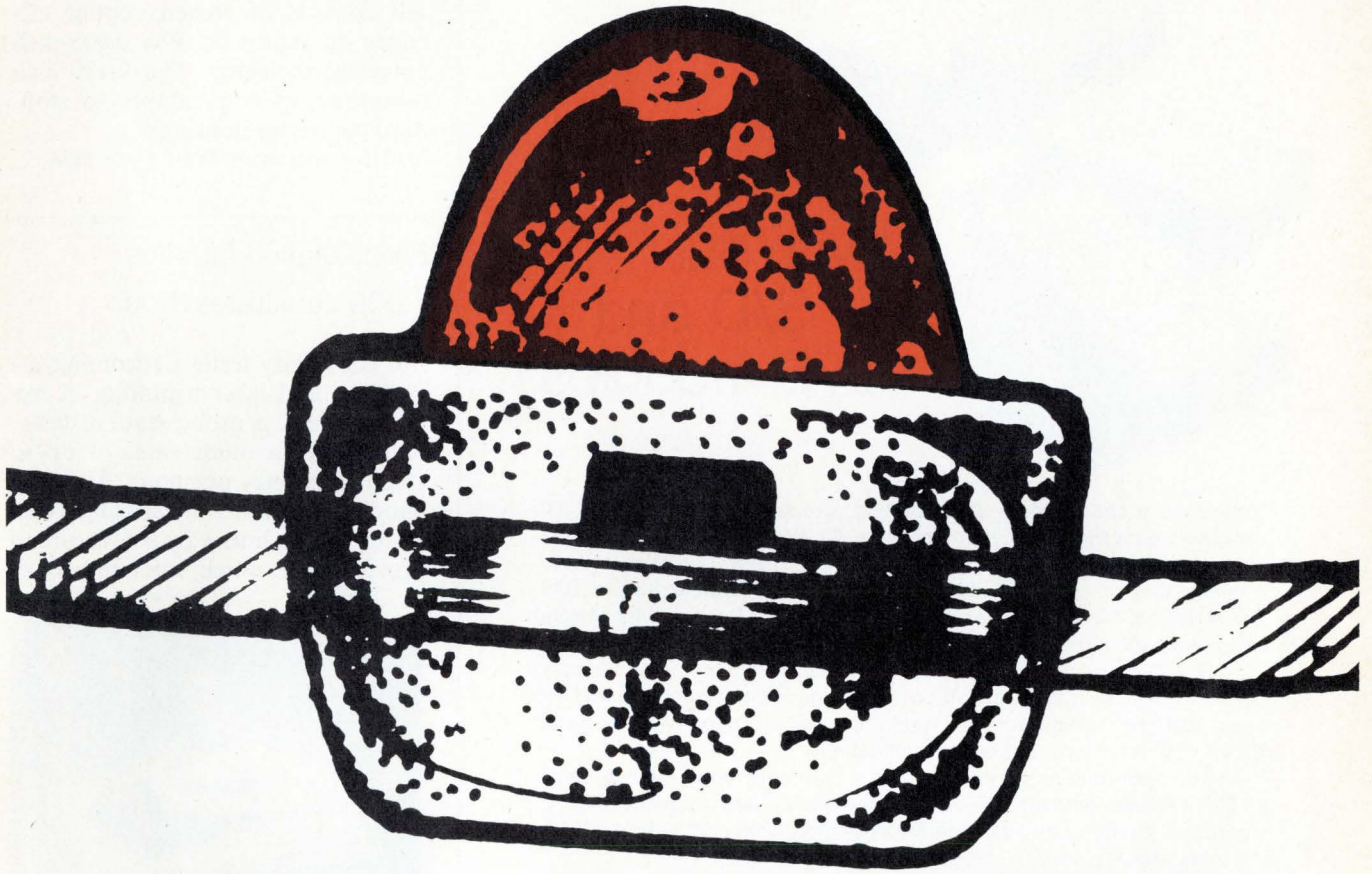

Our littlest GaAsLITE® light emitting diodes, the MV50 series, have been the lowest cost, highest volume solid-state light bulbs in the industry since we introduced them back in 1969. And the reasons you should specify them are all the standard ones:

PRICE

Suggested retail prices as low as 9¢ each in million-lot orders.

AVAILABILITY

They're on distributors' shelves for instant delivery. OEM quantities can be timed to meet your realistic release dates.

RELIABILITY

Completely solid state, they don't burn out. We've shipped over 12 million of them in the last five years and have accumulated life test data of 13.7 million device hours.

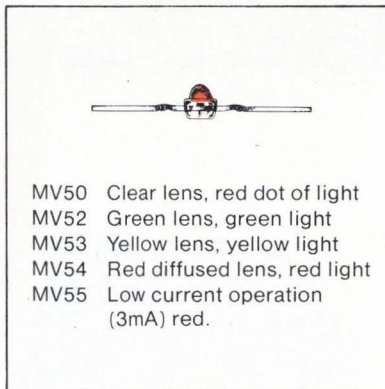

- MV50 Clear lens, red dot of light
- MV52 Green lens, green light
- MV53 Yellow lens, yellow light
- MV54 Red diffused lens, red light
- MV55 Low current operation (3mA) red.

APPLICATIONS

They are prime candidates for pc board diagnostics and small indicator lamps. Small form factor makes them great for array-building. And we're glad to help you fit them into any socket. Ask for applications assistance any time.

OUR NAME

We helped get this solid-state light industry going. We plan to be around as long as your equipment lasts.

So if you're looking for a little light, now's the time to buy MV50's. And if you're interested in small yellow and green GaAsLITEs, ask about our MV52 and MV53. We'll be glad to send all the standard data. **Monsanto Commercial Products Company**, Electronics Division, 3400 Hillview Avenue, Palo Alto, CA 94304. Phone: (415) 493-3300.

Putting innovation to work

Monsanto

OUR ANGLE:

More Synchro Conversion For Less Cost



with our
S/D and
D/S modules

How does a choice of 14-bit resolution (greater for 2-speed S/D), 60 or 400 Hz data frequency, high accuracy, 11.8V to 90V line-line voltages and all kinds of self-protection circuitry — look from your angle? Not to mention that as few as 5 modules make up a complete S/D or D/S converter, or that all modules are replaceable one-for-one without trimming! And, economically too!

New 2-speed S/D sets are now available with accuracies typically better than 20 seconds from all error sources including resolution. D/S specifications include 4 minute accuracy, 1.25 VA output with optional 20 VA output for torque receiver applications.

Key performance specifications for both converters include 14-bit (0.022°) resolution over 360°, 4000°/sec analog data rates and 0-70°C operation. Some units available for operation from -55°C to +105°C. All units are DTL and TTL compatible.

Prices start at \$650.00 for a set of modules. Delivery from stock. Call toll-free (800) 645-9200 for the name and address of your local sales engineering representative.



NORTH ATLANTIC industries, inc.

200 Terminal Drive, Plainview, New York 11803 • Phone (516) 681-8600
California District Office: 13418 Wyandotte Street, N. Hollywood, CA 91605 • Phone (213) 982-0442

Circle 178 on reader service card

Cost Cutter

NEW Electronics Buyers' Guide...

Easy-to-use, single volume
source for:

- Data on over 4,000 products
- Over 6,000 company listings and phone
- **EBG EXCLUSIVE:** quick access to over 800 catalogs through a Direct Inquiry Service. numbers

The international world of electronics at your fingertips. Find suppliers...fast...accurately...and locally! For your copy send \$15.00 (USA and Canada only; elsewhere send \$25.00) to address shown below.

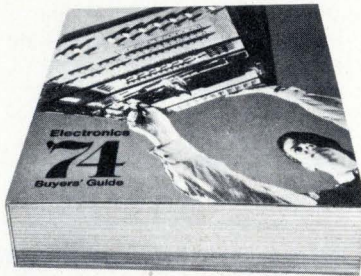

Electronics Buyers' Guide

A McGraw-Hill Publication
1221 Ave. of the Americas, New York, N.Y. 10020

178

New products

impedance types. The geometry of the cable eliminates the need to generate specialized artwork or cables for each situation. The cable itself consists of etched copper circuitry on each side of a 0.005-inch polyester dielectric. The 0.100-inch centerline spacing adapts to standard connector housings.

AMP Inc., Harrisburg, Penn. 17105 [394]

Probe station handles
1,000 substrates/hour

For continuity testing, incoming inspection and laser trimming of hybrid devices, a probe station designated Omega offers rates of up to 1,000 substrates per hour. The unit handles substrates measuring from 0.5 by 0.5 inch to 3 by 3 inches and provides for quick interchange of



standard 4.5-inch fixed-pattern probe cards. The system is equipped with a Sterozoom microscope with a 1-inch field of vision and a built-in illuminator for alignment of the probe cards.

Micro Dynamics, 9855 Dupree, South El Monte, Calif. 91733 [395]

Rf crimp tool system
links cables, connectors

An rf cable-to-connector crimp tool system, enabling assembly of multiple rf connector series to RG-/U cable groups, consists of a universal tool frame and interchangeable crimping dies that are designed to match the specific cable and connector being assembled. The new sys-

Electronics/September 19, 1974

Increase multilayer capabilities with Micapak™ from the multilayer experts.

Increase production without an added investment.

Increase your multilayer production without increasing your facilities or personnel. With Micapak™ you get the convenience of three or four layer multilayer "blanks" ready to be processed into finished multilayer boards using standard two-sided board techniques.

Choose from Micaply® highly stable polyimide glass laminates, epoxy glass laminates, Micaply Ohmega™ resistor-conductor laminate for circuits with integral thin film type resistors, or Micaply® Thin Copper clad laminate.

Fast turn-around on large quantities of three and four layer boards.

The Micapak™ process is convenient and fast. You send us "cores" (18" x 42" or 24" x 36" sheets) with layers two and three etched in registration to each other. We'll laminate them and add external copper foil for layers one and four. Then we'll return

them to you for processing into finished boards. Or, if you wish, we'll perform complete "core" processing.

Yield from our large laminate sheets is increased by laying out boards to maximize the number per sheet.

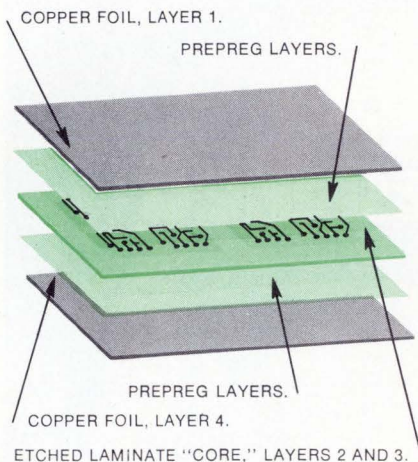

Typical Micapak™ multilayer "blank" (as large as 24" x 36") before lamination. Inner laminate is etched with both sides in registration to each other.

We have the know-how and multiple platen presses to laminate these large sheets in quantity to a quality level unsurpassed by anyone.

Inventory Micapak™ "blanks" for completion as needed.

Micapak™ enables you to inventory pre-etched, laminated multilayer "blanks" for processing the external layers at your convenience. *This can cut weeks from delivery schedules!*

Typical applications include the use of common power and ground planes. Outer layers can be designed and completed at a later date to particular requirements.

The Mica Corporation: Printed circuit experts for over 20 years.

Use the laminates and laminating facilities of the multilayer experts to increase your circuit quality, yield and turn-around time. Call us with your requirements. We'll show you how — the easy, reliable Micapak™ way.

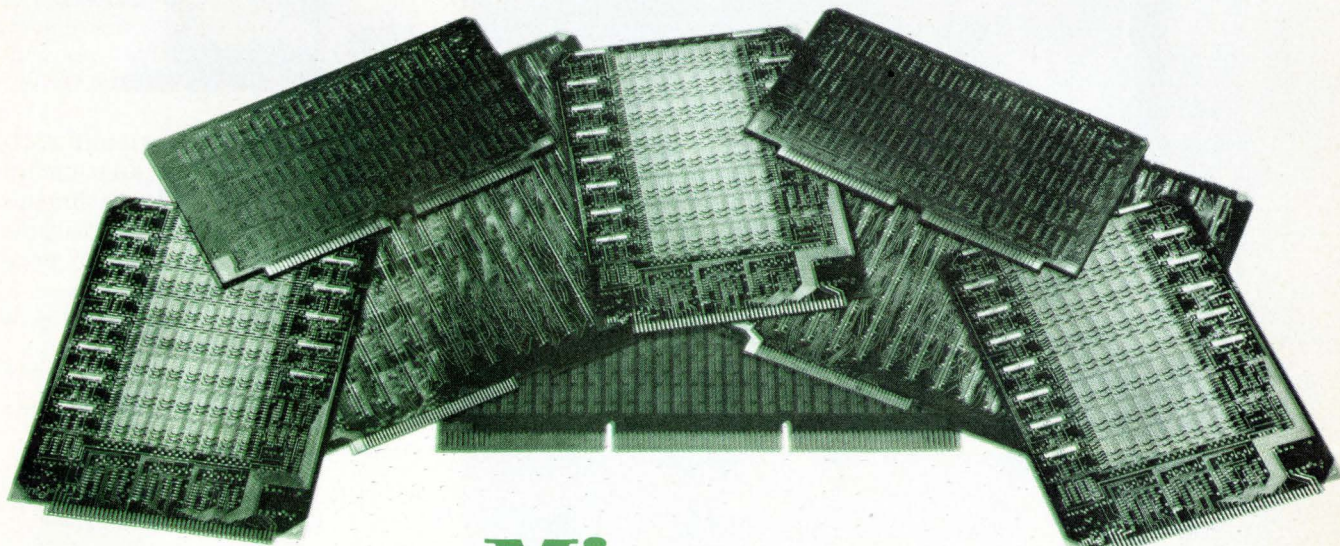

The **Mica** Corporation

10900 Washington Boulevard, Culver City, California 90230, (213) 559-4223, TWX: 910-340-6365; Telex: 674999

Micaply International, Ltd. Silloth, Cumbria, England, Silloth 571, Telex: 64120, Cable: Micaply, Silloth

When performance counts!

**At
Eastern Air Devices
we think
stepping motors
should be designed
to fit
the system.
Not the other
way around.**



Eastern Air Devices, Inc.
Dover, N.H. 03820 • (603) 742-3330 • TWX: (510) 297-4454

Syn & Ind Motors • Gearmotors • Fans • Blowers

Circle 180 on reader service card

New products

tem is said to reduce user hand-tool costs and increase flexibility of crimp terminations. Applications include any factory and/or field installation where several rf series connectors are being employed. Price of the universal tool frame is \$87. Interchangeable crimping dies cost \$37 per set.

Amphenol RF division, 33 E. Franklin St., Danbury, Conn. 06810 [393]

Lead-forming unit handles
1,600 components an hour

A pneumatic component lead-forming machine, which operates at rates in excess of 1,600 components per hour, can be foot-actuated or operated with its automatic pacer. With optional automatic feed attachments, the model 45000 can increase component output to more than



14,000 per hour. Optional reel-holder and card-feed attachments are also available. All attachments are installed using two machine screws. The unit operates on pressure of 70 pounds/square inch.

Kinatech Systems, 9674 Telstar Ave. El Monte, Calif. 91731 [396]

C-MOS housed in Cerdip
for rugged environments

A frit-sealed ceramic dual in-line package has been developed by Solid State Scientific for the company's line of C-MOS products des-

Electronics/September 19, 1974

After your 360/370 massages the information, a Gould Plotmaster can draw you a picture within 3 seconds.

If alphanumeric information is what you want, a Gould Plotmaster can print it for you. At speeds up to 3000 lines per minute. But there are times when alphanumeric listings are just too much. Too much paper to handle, too tough to read, too difficult to digest.

And it's at times like these that a Gould Plotmaster can draw you a picture. A line chart, a bar chart, a pie chart, a graph. A picture that tells your story at a glance.

Employing high-speed electrostatic printer/plotters, Gould Plotmaster Systems give you power and versatility for both on-line and off-line operation. And they're designed to run on any IBM System/360 or 370 operating under DOS or OS, real or virtual.

Easy-to-use software packages help our Plotmaster Systems do the whole job. There's our DISPLAY package that provides even non-programmers with the capability of easily generating line, bar and pie charts. And there's our PLOT package which, due to the speed

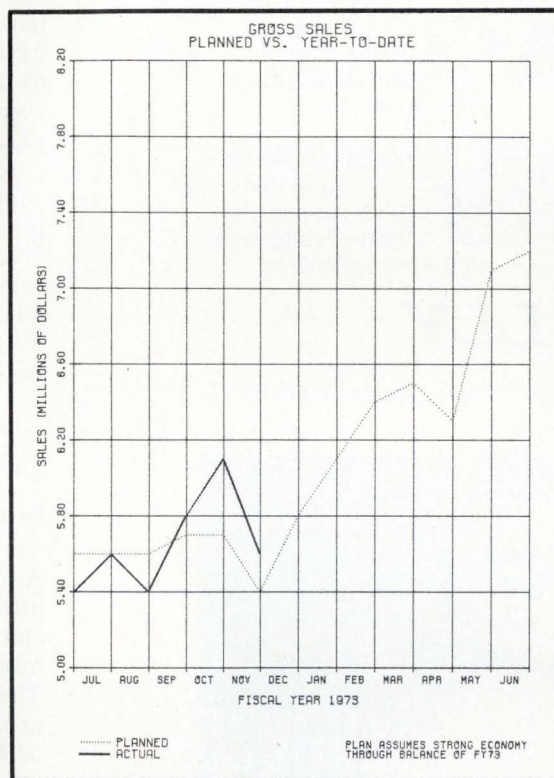

and flexibility of our printer/plotters, lets you do background grids, variable line weights, automatic stripping, text annotation, and allows you to erase previously programmed line segments.

All software is written in assembler language to con-

serve internal storage and make efficient use of your main computer — yet each subroutine package is callable from Fortran for ease of operation and efficiency in preparing input.

As for the hardware itself, our Plotmaster Systems can provide on-line/off-line operation, paper widths up to 22 inches, resolution up to 100 dots per inch, output speeds up to 7 inches per second. And, of course, a printing capability, as well.

Get all the facts on Plotmaster Systems from Gould Inc., Instrument Systems Division, 20 Ossipee Road, Newton, Mass. 02164 U.S.A. or Kouterveldstraat 13, B 1920 Diegem, Belgium.

 **GOULD**

The high performance photoreader family

With an eye focused on giving you top price/performance, Tally brings you a family of photoreaders loaded with features.

Here's the line-up.

Model R-2050

The new Tally R-2050 delivers 250 characters per second for only \$275. Or \$375 with com-



plete electronics. The compact, super reliable unit features easy, adjustment-free operation.

Model R-2000

For added performance power, the R-2000 comes complete with power supply and bi-directional drive elec-

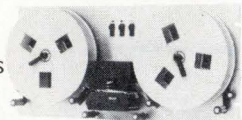

tronics. Prices start at \$546. Numerous options can be added. Speed is 300 cps continuous and 200 cps asynchronous.

Model R-5000

For those applications that demand the very best, the top of the line R-5000 has

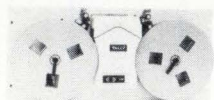

speeds of 500 cps continuous and 1200 cps search. It's the reader with all the extras built-in.

TALLY®

Get the full story. Write or call Tally Corporation, 8301 So. 180th St., Kent, Washington 98031. Phone (206) 251-6771. Circle 182 on reader service card

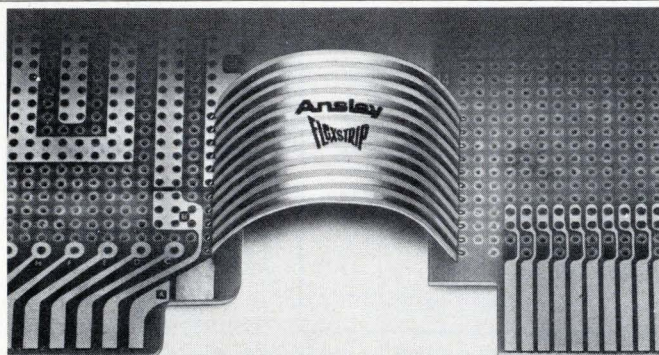

Bridge the PCB gap

Ansley Electronics patented FLEXSTRIP® Jumpers provide a fast, low cost and reliable interconnect between rigid PC boards and from boards to connectors. Engineered for failure free flexing, they solve problems of density and flexibility at lowest installed cost.

Ready to use . . . with no stripping or cutting to length required, FLEXSTRIP® Jumpers have flat conductors for flexibility and round pins for easy P.C. Board insertion. Four standard insulation materials, four standard pin configurations with options available. Standard P.C. centers from .050" to .200". Pin strips and sockets also available.



Ansley

ANSLEY ELECTRONICS CORP.
Subsidiary of Thomas & Betts Corporation

3208 Humboldt St., Los Angeles, Ca. 90031 Tel. (213) 223-2331

Sold Coast to Coast Through Authorized Ansley Distributors.

New products

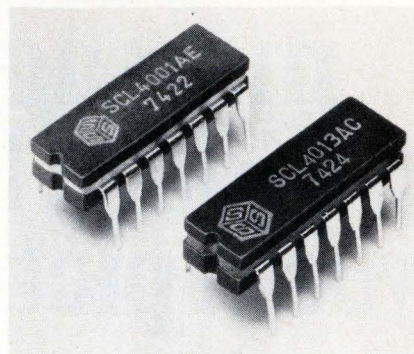

igned the SCL 4000 series. The devices operate over a range of -55 to 125°C and are designed for severe environmental situations. Applications include industrial control, automotive equipment, and telecommunications. All 14-pin and 16-pin C-MOS devices are now available in the package. Price, in quantities of 100, vary from 84 cents to \$4.04 each.

Solid State Scientific Inc., Montgomeryville, Pa. 18936 [397]

One-piece connectors terminate flat cable

A series of one-piece connectors that interface flat cable with printed circuit boards can simultaneously terminate as many as 50 conductors. They are available in pin lengths to accommodate board thicknesses of 0.031 to 0.094 inch. Four contact points per conductor are provided

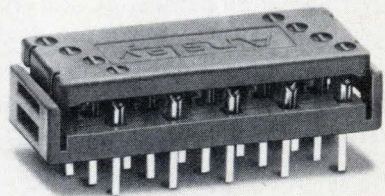

and a strain relief is built into the individual contact as well as the connector body for terminations in hostile environments. The connectors have a current rating of 1 ampere and dielectric strength of 1500 V dc.

Ansley Electronics Corp., 3208 Humboldt St., Los Angeles, Calif. 90031 [399]

MARK TEN B, THE GAS SAVING, PLUG SAVING, TUNE-UP SAVING, ELECTRONIC IGNITION FROM DELTA. NOW AS LOW AS \$49.95.



Years of testing and use by race car drivers in all categories have proven Delta's Mark Ten B the most advanced ignition system on the market today.

Prove it to yourself. Give you car vroom! With a Mark Ten B Capacitive Discharge Ignition System under the hood of your car great things will happen...like reducing costly tune-ups by as much as 75%. Further, you get better all-weather starts, quicker acceleration and better mileage.

Many operational problems caused by emission control devices, poor manifold or improper fuel mixtures disappear. Delta's Mark Ten B even improves the performance of brand-new factory installed electronic ignitions (Chrysler and Ford). Factory systems merely eliminate points and condenser, but the Delta Mark Ten B combines the advantages of capacitive discharge with solid state

electronics to give real performance and increased energy.

Are you a do-it-yourselfer? Build your own Mark Ten B...it's available in low-cost

kit form. Or, if you prefer, get the complete ready-to-install unit. Either way, you can install it yourself in minutes with no rewiring, even over Chrysler and Ford systems.

Mail the coupon today and discover how to enjoy happy motoring with Delta's Mark Ten B. The do-it-yourselfer's dream that really pays off.



DELTA PRODUCTS, INC.

P.O. Box 1147, Dept. E Grand Junction, Colo. 81501
303-242-9000

Please send me free literature.

Enclosed is \$ _____ Ship ppd. Ship C.O.D. Please send: _____ Mark Ten B assembled @ \$64.95 ppd. _____ Mark Ten B Kit @ \$49.95 ppd. (12 volt negative ground only) _____ Standard Mark Ten assembled, @ \$49.95 ppd. _____ 6 Volt: Neg. Ground Only _____ 12 Volt: Specify _____ Pos. Ground _____ Neg. Ground _____ Standard Mark Ten Deltakit® @ \$34.95 ppd. (12 Volt Positive or Negative Ground Only)

Car Year _____ Make _____

Name _____

Address _____

City/State _____ Zip _____

COMPUTERS AND COMMUNICATIONS SEMINAR

Seminar Chairman: J. Prendiville, New England Telephone Co., Boston, MA

Wednesday and Thursday, October 30 and 31

Commonwealth Ballroom of the Sheraton-Boston Hotel

9:30 am, Wednesday

S-9 COMPUTER CONTROL IN SUPERVISION IN COMMUNICATIONS

Chairman: W. B. Groth, IBM Corp., White Plains, NY

A COMPUTERIZED TOLL TICKETING SYSTEM — J. R. McHugh, IBM Corp., Boca Raton, FL

STORED PROGRAM CONTROL OF A KEY/PABX BUSINESS COMMUNICATION SYSTEM — J. G. Mlacak, Bell Northern Research, Ottawa, Ontario

ROLE OF COMPUTERS IN MOBILE DATA COMMUNICATION SYSTEMS — A. M. Goldstein, Motorola, Inc., Schaumburg, IL

INTERNATIONAL DIGITAL DATA SERVICE/COMPUTER APPLICATION — K. M. Jockers, Western Union International, Inc., New York, NY

2:00 pm, Wednesday

S-10 COMPUTERS/HELPING THE COMMUNICATIONS INDUSTRY DO A BETTER JOB

Chairman: R. C. Cady, Digital Equipment Corp., Maynard, MA

MINICOMPUTER AIDED TRAFFIC MEASUREMENT AND ANALYSIS — J. Mannino, Applied Data Research, Inc., Princeton, NJ

MINICOMPUTERS IN A TELEPHONE OPERATING COMPANY/THE IMPACT ON MANAGEMENT AND ORGANIZATION — G. A. Barletta, New York Telephone, New York, NY

MINICOMPUTERS ENHANCEMENT TO TELEPHONE SWITCHING MAINTENANCE SYSTEMS — C. J. Many, Bell Telephone Labs, Holmdel, NJ

MINICOMPUTER CONTROLLED MEASUREMENT OF VOICE BANDWIDTH TRANSMISSION CIRCUIT PARAMETERS — I. E. Hardt, Collins Radio Co., Cedar Rapids, IA

9:30 am, Thursday

S-11 NEW COMMUNICATIONS SERVICES

Chairman: R. Alter, Packet Communications Inc., Waltham, MA

DATAPHONE DIGITAL SERVICE — C. F. Stuehrk, AT&T Co., New York, NY

DATRAN'S SWITCHED DIGITAL NETWORK — E. V. Farinholt, Data Transmission Co., Vienna, VA

PACKET-SWITCHED DATA COMMUNICATIONS SERVICES — L. R. Talbert, Packet Communications Inc., Waltham, MA

PANEL DISCUSSION

2:00 pm, Thursday

S-12 PRACTICAL ASPECTS OF COMPUTER COMMUNICATIONS SYSTEMS

Chairman: S. M. Isaacs, State Street Bank and Trust Co., Boston, MA

REAL TIME AND BATCH TRANSMISSION SYSTEMS PROJECT MANAGEMENT/ARE THEY REALLY DIFFICULT? — I. H. Derman, National BankAmericard, Inc., San Mateo, CA

SWITCHING, PATCHING, MONITORING AND TESTING AT THE EIA DATA INTERFACE — R. B. Sepe, A. Lucci and R. A. D'Antonio, International Data Sciences, Inc., Providence, RI

WHEN TO USE PABX'S IN DATA NETWORKS — M. F. Roetter, A. D. Little, Inc., Cambridge, MA

THE COST OF SECURITY IN COMPUTER-COMMUNICATIONS SYSTEMS — D. W. Lambert, MITRE Corp., Bedford, MA

REGISTRATIONS REC'D BY OCT. 15TH

IEEE Members \$80 Non-Members \$99

REGISTRATIONS REC'D AFTER OCT. 15TH

IEEE Members \$95 Non-Members \$125

Registration fee includes one copy of the Seminar Proceedings and free registration to general program and exhibits.

Comp-Com

Name _____

Address _____

Checks payable to: NEREM-74

31 Channing St. Newton, MA 02158

New products/materials



A low-viscosity epoxy casting resin is specially formulated for easy and rapid evacuation. Stycast 2057 has a low surface tension, affording good air release. At temperatures from -100 to 350°F , the resin can be used as an impregnating and encapsulating material for circuit modules, connectors, and other electrical/electronic components. It can also be used with a dissolved oxygen analyzer probe for a water-treatment process, as shown above.

Emerson and Cuming Inc., Canton, Mass. 02021 [476]

A high-resolution, low-K crystallizable thick-film dielectric, EMCA 3186B, is used in multilayer high-density circuits. Firing temperature of the dielectric is 850° to $1,000^{\circ}\text{C}$ for 10 to 15 minutes at peak temperature; when double-printed, using a 325-line-per-inch mesh screen, fired thicknesses between 1.1 and 1.4 mils are obtained. EMCA 3186B is inert to refriring cycles. Price is \$25 per ounce in quantity.

Electro Materials Corp. of America, 605 Center Ave., Mamaroneck, N.Y. [477]

Ultraflex 300, a silicone dielectric, meets the encapsulation requirements of maximum flexibility, physical strength, thermal stability, and functional reliability. It has a tensile strength of 1,300 pounds per square inch, an elongation percentile of 600 and a durometer hardness of Shore A 60 to 70, but its principal advantages for such applications as flexible cable are its thermal stability

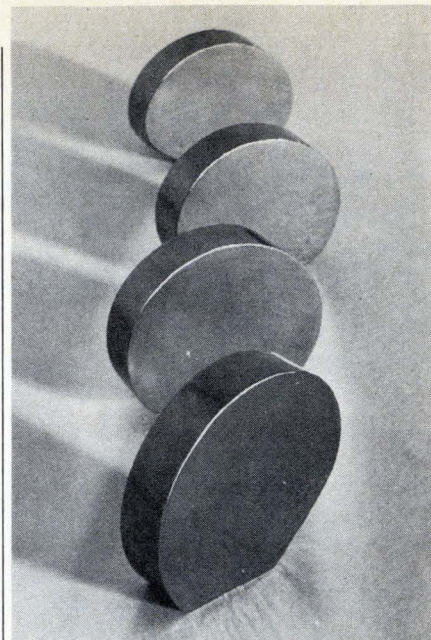

Our compounds are your right answer for...

DIODE DISPLAYS, INFRARED DEVICES, ELECTRONIC COMPONENTS

Asarco Intermetallics Corporation offers a wide range of III-V compounds used in the production of light emitting diodes (LED) and photoluminescent displays.

We provide gallium arsenide, gallium phosphide and indium phosphide in both polycrystalline and single crystal form. All polycrystalline materials are available as ingots. Gallium phosphide and indium phosphide are also available in granular form.

Gallium arsenide single crystals are boat grown with typical cross-sections of 19mm x 47mm for a (111) orientation and 33mm x 47mm for a (100) orientation.

You can order single crystals of our III-V compounds as ingots or slices, as cut or polished.

All materials are furnished in small quantities for evaluation or in large volume for production use. For more information contact us at 120 Broadway, New York, N.Y. 10005. Or call 212-732-9500.

ASARCO INTERMETALLICS CORPORATION

Circle 224 on reader service card

What you can't see can hurt you.



Unless you have mass, atomic-absorption, infrared and X-ray spectrographs, scanning and transmission-electron microscopes, scanning electron microprobes, X-ray fluorescence. Or us.

New independent analytical service.

Airco's new Analytical Services provides a full line of services for industrial, scientific and educational applications. We offer full gas analyses including calibration gas, gas identification and gases in metals and ceramics. We also provide environmental, organic and inorganic analyses. And we have portable instrumentation to conduct on-site analyses for many areas.

As a major supplier of industrial and rare and

specialty gases, we have an experienced staff and fully equipped lab to handle any analysis problem. They'll provide a complete gas analysis from any supplier (you don't even have to tell them who it's from) and they won't hesitate to tell you when a gas isn't as pure as it should be, even if it's ours.

For complete information, write or call Hank Grieco, Airco Industrial Gases, 575 Mountain Ave., Murray Hill, New Jersey 07974 (201) 464-8100.

AIRCO
Industrial Gases

1%

AMERICAN MADE

Tolerance **SCHAUER** 1-Watt **ZENERS**

**Immediate Shipment
Low Prices**

ANY voltage from 2.0 to 16.0

Quantity	Price each
1-99	\$1.07
100-499	.97
500-999	.91
1000-4999	.86
5000 up	.82



All welded and brazed assembly

No fragile nail heads

Gold plated leads

Write for complete rating data and other tolerance prices.

Buy the kit- Save a lot



Kit contains a 51-piece assortment of SCHAUER 1% tolerance 1-watt zeners covering the voltage range of 2.7 to 16.0. Three diodes of each voltage packaged in reusable poly bags. Stored in a handy file box. Contact your distributor or order direct.

A \$54.57 value for
ONLY \$24⁵⁰

Semiconductor Division

SCHAUER

Manufacturing Corp.

4514 Alpine Ave. Cincinnati, Ohio 45242
Telephone: 513/791-3030

New products/materials

and high resistance. Delivery time for production quantities tailored to customer specifications is four to six weeks.

Cicoil Corp., 9324 Topanga Canyon Blvd., Chatsworth, Calif. [478]

A **clad process** for the manufacture of TO-92 lead frames is said to decrease cost as much as 50%. The process eliminates the plating stage of TO-92 fabrication and reduces the amount of gold used in the part. Rather than plating, a thin 50-microinch layer of gold is selectively clad onto a copper-alloy base. The gold stripe then serves as a contact area after stamping. The clad is available on finished stamped parts and as a materials system, ready for customer stamping.

Plessey Inc., Materials Division, Melville, N.Y. [479]

A **dual-purpose** plating-resist for printed-circuit boards can also be used as an etch-resist. As a plating-resist, the material, known as No. 145-34-S, provides adhesion and resistance to gold, copper, tin-nickel and solder-plating baths. As an etch-resist, it will withstand the common acidic etchants used for copper. The material is a modified vinyl solution colored by a black dye, but is available in other modified viscosities and colors.

Hysol-Wornow Division, The Dexter Corp., 15051 East Don Julian Rd., Industry, Calif. 91744 [480]

A **resin** for use in insulating stators, armatures, and other substrates needing a moisture- and chemical-resistant dielectric is called Scotchcast 260 EC². The resin is based on 3M Co.'s 260 powdered epoxy resin, but has improved edge coverage and consistency, resulting in a more uniform coating on flat surfaces and high points. When applied to an article that has been heated to a temperature above that of the melting point of the resin, 260 EC² will melt on contact, forming an integral insulation.

3M Co., Industrial Electrical Products Division, Dept. IEP4-18, Box 33686, St. Paul, Minn. 55101 [340]

Different hopes for different folks.



People want different things from a college education.

But they all agree on one thing. It takes more than brains to get a diploma.

Why not make the burden a little easier? Start buying U.S. Savings Bonds now.

Bonds are a dependable way to build a college fund for your children. And an easy way to start saving them is by joining the Payroll Savings Plan.

Start a college fund now with U.S. Savings Bonds. They just might let your kids spend more time studying and less time working to stay in school—whatever they hope to be.



Take stock in America.

Buy U.S. Savings Bonds

Now E Bonds pay 5½% interest when held to maturity of 5 years, 10 months (4% the first year). Bonds are replaced if lost, stolen, or destroyed. When needed they can be cashed at your bank. Interest is not subject to state or local income taxes, and federal tax may be deferred until redemption.



The U.S. Government does not pay for this advertisement. It is presented as a public service in cooperation with the Department of the Treasury and The Advertising Council.

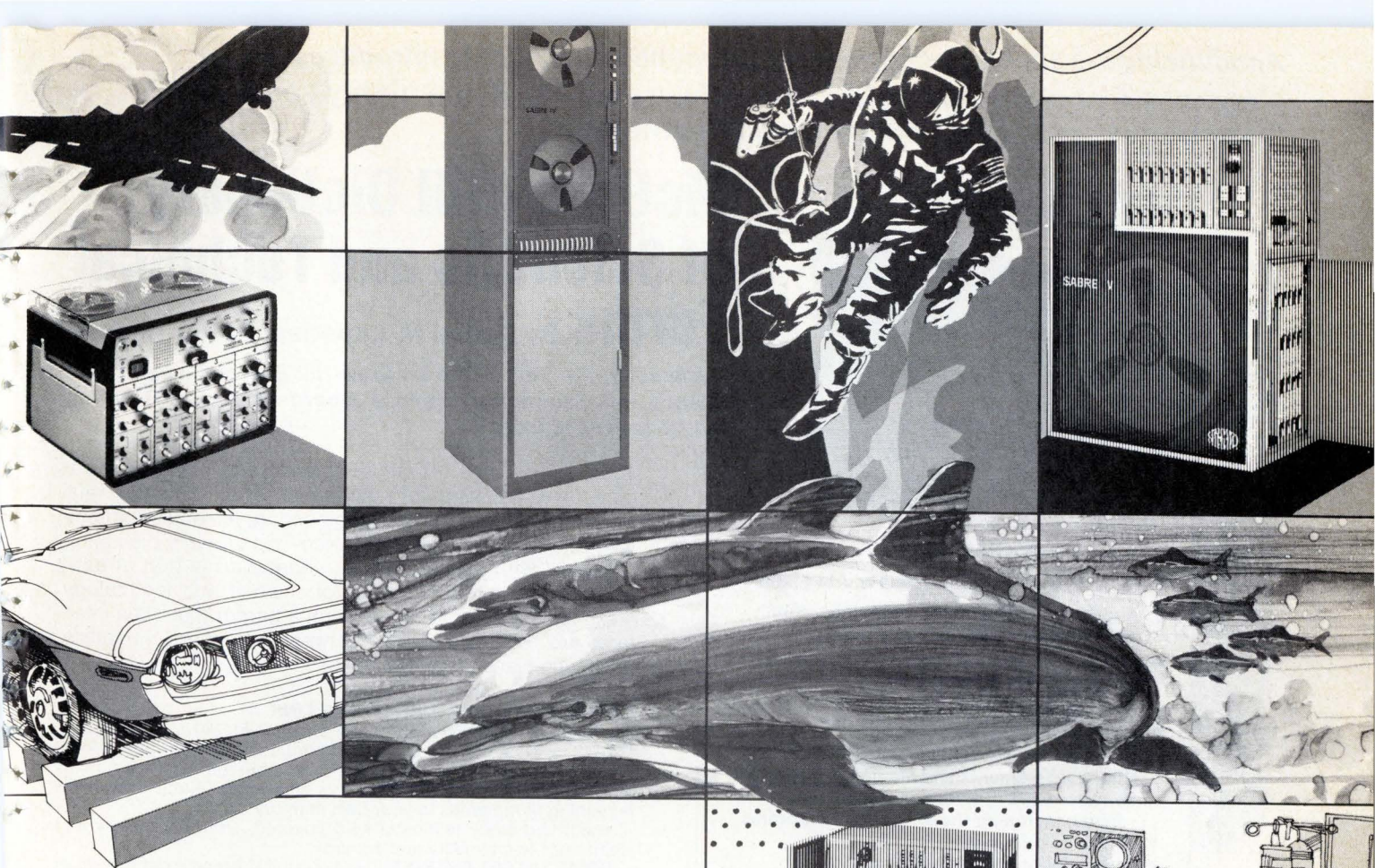

Sangamo makes recorders with enough channels for space science and enough economy for hospital labs.

If you need 48 channels of data, we build the only IRIG all-band tape recorder on the market—the Sabre IV.

If you are in the life sciences and need an efficient economical recorder for less than \$5,000, you can buy a Sangamo/Tandberg TIR model that does almost everything a \$16,000 recorder can do. And it's no bigger than a breadbox.

Between the two extremes are the Sabre III, the all-band 7 and 14 channel portable, featuring laboratory quality, and the Sabre V, the most advanced portable 28 or 32 channel recorder/reproducer available.

That's a wide range of capabilities. An even wider range of prices. The one thing that never varies is the quality. Sangamo recorders do the best job on every job. Including yours.

For details write: Sangamo Electric Company, Data Systems, P.O. Box 3347, Springfield, Illinois 62714, or call (217) 544-6411/Telex 406-421. Sales and Service Representatives World Wide.

SANGAMO RECORDERS

THE INNOVATORS IN TAPE INSTRUMENTATION
Circle 187 on reader service card

Announcing—a special money-saving pre-publication offer to introduce . . . a complete one-volume guide—fully illustrated—to all the highly specialized “languages” of today’s science and technology.

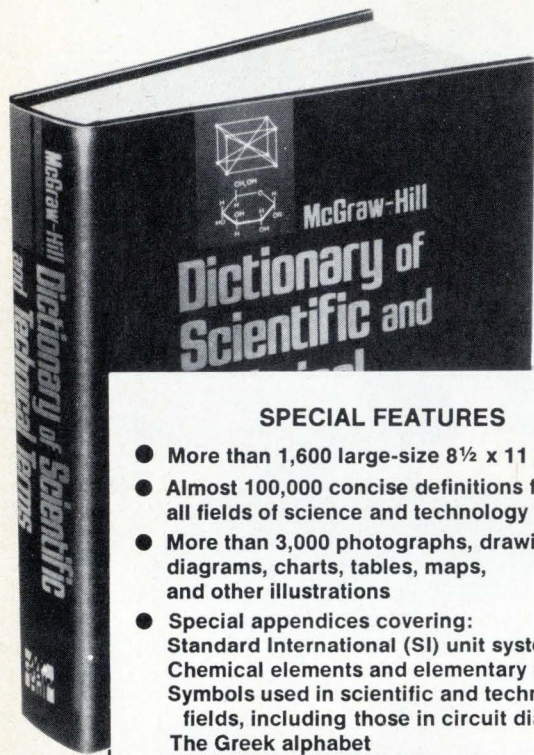

McGraw-Hill Dictionary of Scientific and Technical Terms

By Daniel N. Lapedes, Editor-in-Chief

Prepared by the Staff of the McGraw-Hill Encyclopedia of Science and Technology; and a Board of 29 Contributing and Consulting Editors

SPECIAL FEATURES

- More than 1,600 large-size 8½ x 11 pages
- Almost 100,000 concise definitions from all fields of science and technology
- More than 3,000 photographs, drawings, diagrams, charts, tables, maps, and other illustrations
- Special appendices covering:
 - Standard International (SI) unit system
 - Chemical elements and elementary particles
 - Symbols used in scientific and technical fields, including those in circuit diagrams
 - The Greek alphabet
 - Abbreviations for scientific and technical organizations

MODERN, ATTRACTIVE, WELL ILLUSTRATED FORMAT

Following the innovative dictionary format pioneered by the famous American Heritage Dictionary of the English Language, the McGraw-Hill DICTIONARY OF SCIENTIFIC AND TECHNICAL TERMS now revolutionizes the field of technical dictionaries.

Eminently readable type and generous margins filled with **more than 3,000 photographs, drawings, diagrams and other illustrations** contribute to its ease of use.

Each entry is identified with the field of science in which it is primarily used. If a term has more than one meaning and covers other disciplines, those definitions are also given and their fields identified.

USEFUL INTERNATIONALLY

In anticipation of the world-wide use of the metric system, the Dictionary features, in each definition where U.S. customary units appear, the metric system equivalents.

As a busy professional, you owe it to yourself to examine this practical working tool. You will find that it meets your most demanding criteria for clear, concise definitions.

Don't take our word for it. Reserve your copy now for 10-days FREE examination upon publication in October. And, by mailing in the coupon today, you can take advantage of our special pre-publication offer that saves you \$7.00.

The major fields covered and identified with each entry . . .

Acoustics	Civil	Geodesy	Meteorology	Pharmacology
Aerospace	Engineering	Geography	Microbiology	Physical
Engineering	Climatology	Geology	Mineralogy	Chemistry
Agriculture	Communications	Geophysics	Mining	Physics
Analytical	Control Systems	Graphic Arts	Engineering	Physiology
Chemistry	Cryogenics	Histology	Molecular	Plant Pathology
Anatomy	Crystallography	Horology	Biology	Plasma Physics
Anthropology	Cytology	Hydrology	Mycology	Psychology
Archaeology	Design	Immunology	Naval	Quantum
Architecture	Engineering	Industrial	Architecture	Mechanics
Astronomy	Ecology	Engineering	Navigation	Relativity
Astrophysics	Electricity	Inorganic	Nuclear Physics	Solid-state
Atomic Physics	Electromagnetism	Chemistry	Nucleonics	Physics
Automatic Data	Electronics	Invertebrate	Oceanography	Spectroscopy
Processing	Embryology	Zoology	Optics	Statistical
Biochemistry	Engineering	Lapidary	Ordnance	Mechanics
Biology	Engineered	Mapping	Organic Chemistry	Statistics
Biophysics	Acoustics	Materials	Paleobotany	Systematics
Botany	Evolution	Mathematics	Paleontology	Systems
Building	Fluid Mechanics	Mechanical	Pathology	Engineering
Construction	Food Engineering	Engineering	Particle Physics	Textiles
Chemical	Forestry	Mechanics	Petroleum	Thermodynamics
Engineering	Genetics	Medicine	Engineering	Vertebrate Zoology
Chemistry	Geochemistry	Metallurgy	Engineering	Virology
			Zoology	

Today's explosive growth of science and technology has generated thousands of new terms not only in such relatively new fields as nuclear engineering, molecular biology, integrated circuits, and aerospace—but in every discipline. Together with the formidable vocabularies that already exist in the various branches of science and technology, these technical “languages” form a barrier that often interferes with communications between engineers, scientists, and technicians in various fields.

A VITAL NEW COMMUNICATIONS LINK

The McGraw-Hill DICTIONARY OF SCIENTIFIC AND TECHNICAL TERMS provides a brand-new communications tool that makes it easier for you to communicate with other professionals in all of today's fields of technology. It is also an excellent source for refreshing faded areas in your own memory.

You'll find every technical field covered, from astronomy and electronics to chemistry and zoology.

SOME 100,000 ENTRIES give you quick precise definitions of theories, laws, rules . . . outlines of major reactions, processes and methods . . . essential descriptions of important technical apparatus, equipment and instruments.

SAVES YOU TIME, MONEY, EFFORT AND AGGRAVATION

By covering all of science and engineering in one handy volume, the dictionary eliminates time-consuming searches through specialized books and articles for the meaning of some elusive technical term. You save the cost of other dictionaries. You also save your sanity. And think how useful it would be for your secretary when typing technical letters and reports.

You don't have to wade through paragraphs of description; the dictionary is in strict A-to-Z format, cross referenced for synonyms, acronyms and abbreviations to avoid confusion caused by the use of many terms for the same material, process or mechanism. Terms are explained in clear, succinct words, uncluttered with extraneous detail.

SAVE \$7.00 WITH THIS SPECIAL PRE-PUBLICATION OFFER

The regular price of this Dictionary will be \$39.50. If you place your order now, however, you pay only \$32.50, saving \$7.00. This pre-publication offer ends November 1 so send in the coupon now to reserve your FREE examination copy.

SPECIAL PRE-PUBLICATION RESERVATION COUPON

McGraw-Hill Book Co.
1221 Avenue of the Americas, New York, N.Y. 10020



Please reserve _____ copy(s) of the MCGRAW-HILL DICTIONARY OF SCIENTIFIC AND TECHNICAL TERMS (045257-1) for 10 days free examination upon publication in October. At the end of 10 days, I will either remit \$32.50 for each copy ordered, plus tax, postage and handling, or return book(s) without further obligation.

Name _____

Address _____

City _____ State _____ Zip _____

50-C324-4000-3

Offer good only in U.S., and subject to acceptance by McGraw-Hill.

We're looking for sales engineers with an electrical engineering background.

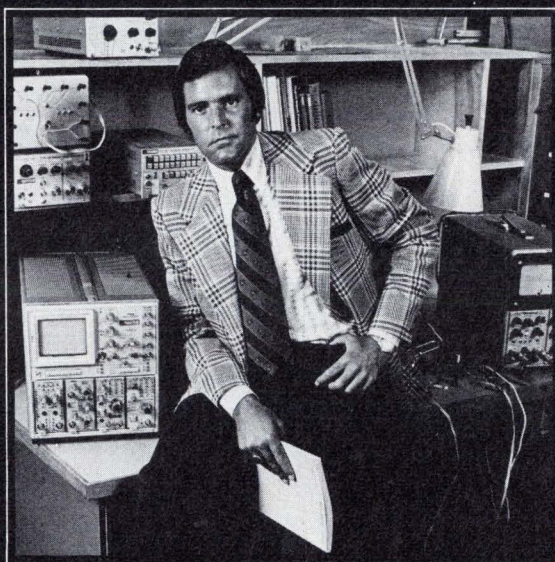

Oscilloscopes, generators, power supplies, spectrum analyzers, counters, DVM's.

Our openings are for professionals, or those who want to be sales professionals. We need people who want to solve problems—who enjoy providing solutions for customers.

We can provide you with:

- The Finest products
 - Incentive compensation programs
 - Benefits Programs including educational, medical, retirement
 - The opportunity for advancement as far as you can go.
- We have a lot to offer.

Call us (503) 644-0161—
or write:

Dan Thompson
Technical Personnel
Resources
P.O. Box 500E27
Beaverton, Oregon 97005

An equal opportunity employer.



TEKTRONIX®
committed to
technical excellence

Circle 189 on reader service card

MONOLITHIC CRYSTAL FILTERS

the
State
of the
Art

TELLING vs. SELLING

The purpose of this column is to disseminate information. Or, to be absolutely honest, to sell by informing. As a responsible engineering or procurement person, you're quite capable of making your own decisions, given the facts. So that's what we give you. We think that the more facts about monolithic crystal filters we present, the more likely you are to buy ours. That's our "let the buyer be aware" theory.

ON SPECIFICATIONS

Writing a component specification is a lot like writing a legal contract. Both can be precise and complete, or vague and ambiguous. Or misleading.

In specifying monolithic crystal filters, one simple method—the boundary method—guarantees desired selectivity—precisely, under specified conditions, without ambiguity. That's why all of PTI's standard specifications are boundary specs. While other methods of specification may make the filter appear in a more favorable light, we feel that this kind of "specmanship" is not in your best interest and hence not in ours.

And boundary specifications—since they are usually intimately related to system requirements—represent a "natural" for the equipment designer preparing a filter spec. One pitfall: in writing boundary specs don't try to include filter manufacturing tolerances. We'll take care of that. Specifying selectivity is only one part of the story. If you need guidance in any aspect of writing specifications for monolithic crystal filters, we may be able to help.

Pti

Piezo Technology Inc.

2400 Diversified Way Orlando, Florida 32804
305-425-1574

The Standard in monolithic crystal filters.

New literature

Switches. Cherry Electrical Products, Box 718, Waukegan, Ill. 60085, has expanded its C-74 catalog to offer complete listings, engineering drawings, operating characteristics, and technical data on switches and keyboards. Circle 421 on reader service card.

Power relays. A 20-page catalog of power relays is available from Magnecraft Electric Co., 5575 N. Lynch Ave., Chicago, Ill. 60630. Specifications and photos are included. [422]

Special-function ICs. National Semiconductor Corp., 2900 Semiconductor Dr., Santa Clara, Calif. 95051, has published a 200-page catalog containing information on a line of analog and digital special-function integrated circuits.

Axial travel switch. Copies of Applications Engineering Bulletin 741 with technical information on the ATS 6000-series high-speed axial-travel switch are available from Gordos Corp., 250 Glenwood Ave., Bloomfield, N.J. 07003. [423]

Wafer-scribing. An eight-page brochure containing information on Laserscribe, a laser-based system for scribing wafers, can be obtained from Quantronix Corp., 225 Engineers Rd., Smithtown, N.Y. 11787 [424]

Components. A catalog listing low-cost electronic items and production aids is available from Mouser Corp., 11511 Woodside Ave., Lakeside, Calif. 92040. [425]

Circuit boards. Kulka Electric Corp., 520 South Fulton Ave., Mount Vernon, N.Y. 10551. A four-page technical brochure defining the 4590A and 4690-4690A thermoplastic high-barrier printed-circuit terminal boards is offered. [426]

Rectifiers. A line of 3-ampere rectifiers, the 30S series, is described in a data sheet from the Semiconductor Division, International Rectifier, 223 Kansas St., El Segundo, Calif. 90245. [427]

Interfaces. National Semiconductor Corp., 2900 Semiconductor Dr., Santa Clara, Calif. 95051, has published a 400-page catalog of linear, digital, and MOS interface products.

High-voltage relays. A 16-page brochure describing key features, specifications, and applications data for a line of high-voltage relays is available from Ross Engineering Corp., 559 Westchester Dr., Campbell, Calif. 95008. [428]

Photographic measurements. Application Note #30T1.1 from Tektronix Inc., Box 500, Beaverton, Ore. 97005, describes how to use the J16 digital photometer/radiometer for photographic-exposure measurements. [429]

Temperature controls. Love Controls Corp., 1714 S. Wolf Rd., Wheeling, Ill. 60090, has published Bulletin 9465, which describes a line of portable temperature controllers. [430]

Surge protection. An eight-page brochure describing the need for surge protection in electronic equipment is available from Telecommunications Industries Inc., 1375 Akron St., Copiague, N.Y. 11726. [431]

Thermocouple calibrations. Bulletin 1111 DB 10 from Barber-Colman Co., 1305 Rock St., Rockford, Ill. 61101, contains condensed temperature/electromotive-force tables for common thermocouple calibrations. [432]

Thyristors. A 68-page pocket-size directory, designated TRP 440A and describing more than 500 thyristors and rectifiers, is available from RCA Solid State Division, Box 3200, Somerville, N.J. 08876. [433]

Peak measurements. Vishay Instruments, 63 Lincoln Highway, Malvern, Pa. 19355, has released a two-page bulletin that describes peak-read option J for use with the company's V/E-13 digital voltmeter and V/E-20A digital indicator. [434]

Hire an alchemist.

With the price of gold, you need someone who can make less costly materials do the work of gold. Or at least cut the gold content of your packages and parts. The materials wizards at Plessey are up to the job. They can cut your costs with:

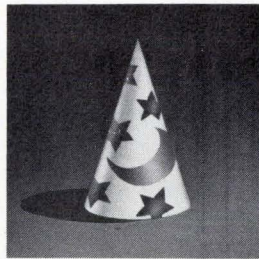

☆ **Selective plating:** By plating gold on critical contact and bonding areas only, you can cut the gold content of plated parts by as much as 80%. Plessey can spot plate or continuous strip plate, depending on your design.

☆ **Precision cladding:** Plessey can clad gold or other precious metals in stripes, toplay or edgelay, as thin as .00005 inches. On Kovar, Alloy 42 or other metals. By having us stamp a clad material you reduce gold content and save time in plating.

☆ **Gold substitutes:** You can eliminate the gold in gold/tin preforms by switching to Foballoy lids. Foballoy is Plessey's proprietary alloy that works just like gold/tin. But costs a lot less. And because the Foballoy is already clad on a Kovar or Alloy 42 cap, you save on assembly costs as well.

☆ **Silver plating:** In many applications, silver plating will meet performance specs just as well as gold plating. And silver clad on aluminum will match the performance of silver.

☆ **Less expensive thick film:** Platinum silver thick film material costs much less than platinum gold and palladium gold. Yet its performance compares very favorably in many product areas.

Call the materials wizards at Plessey. Or, check the product area that's of interest and send us the coupon.

It's a golden opportunity.

Name _____ Title _____

Company _____

Address _____

Telephone _____



PLESSEY INCORPORATED
MATERIALS DIVISION

320 Long Island Expressway South, Melville, N.Y. 11746 (516) 694-7900

Offices in: Cherry Hill, New Jersey; Rochester, New York; Chicago, Illinois; Dallas, Texas; Los Angeles, California; Mountain View, California; San Diego, California; Phoenix, Arizona; Rockville, Maryland; Akron, Ohio; Reading, Massachusetts. Representatives in Boulder, Colorado.

How to ship small packages in a big hurry.

DELTA'S DASH

DELTA AIRLINES SPECIAL HANDLING

On DASH shipments Delta guarantees delivery on the flight or routing you specify between most Delta cities.

Packages accepted up to 50 lbs. with length plus width plus height not to exceed 90" total, with only one dimension exceeding 30".

Deliver to Delta's ticket counter or airport air freight terminal at least 30 minutes prior to scheduled departure time. Shipments may be picked up at either location 30 minutes after flight arrival.

Delta's exclusive "Dashboard" control procedure insures constant tracking of your shipment from delivery to pick-up.

DASH charges are nominal. Check Delta reservations for charges between specific points. Pay in cash, by company check, most general-purpose credit cards, special credit arrangements or on government shipments by GBL. **DELTA**

The airline run by professionals

Rate examples (Tax included)

Atlanta-Washington	\$21.00
Boston-Miami	\$26.25
Cincinnati-Louisville	\$21.00
Cleveland-Phoenix	\$26.25
Los Angeles-New Orleans	\$31.50
Dallas-Los Angeles	\$26.25
San Francisco-Atlanta	\$31.50
Philadelphia-Houston	\$26.25
New York-Tampa	\$26.25

For details, call Delta reservations.



Delta is ready when you are.®

New books

Minicomputer Systems: Structure, Implementation, and Application, Cay Weitzman, Prentice-Hall; 367 pp., \$15.95.

This is an excellent study of mini-computers, and I recommend it heartily despite its merely passable writing style and a few minor errors. Weitzman, formerly with System Development Corp., is now with TRW Systems. His comprehensive knowledge of computer systems first came to this reviewer's attention in an interview and subsequent article which he wrote for *Electronics* on aerospace computers [Sept. 11, 1972, p. 112]. In addition to sharing his expertise, his book contains ample bibliographies at the end of each chapter, and problems, exercises and solutions at the end of the volume.

Chapter 1 begins with a historical discussion and description of various kinds of computers—including a discussion of what a minicomputer is, how minis are applied in man-machine and machine-machine systems, industry standards, and who makes what. There is also a discussion of what minis can and cannot do, and some economic incentives for their use.

Chapter 2 is a discussion of mini-computer hardware, architecture, and memory. But this is an area that may make the book somewhat obsolete, in spite of its 1974 copyright. Weitzman says, "Magnetic core is presently the most commonly used memory element in minicomputers, largely because of its low cost." That's still true, but just barely; designers of several new minis say they used cores only because the new 4,096-bit MOS memory chips weren't available when their designs were frozen. The 4k chips are now coming on fast.

Minicomputer peripherals are the subject of chapter 3—the various types in great detail, including, however, at least one that's no longer on the market. Chapter 4 is on mini software and programming, starting with how to load a program, and also discusses the use of symbolic codes, testing and correcting programs, compilers and higher-level

The pollution problem.

Maybe your engineers deserve a little help.

The engineers' will be the ones to find the technical solutions to pollution problems. There's no doubt about it.

But pollution is a people problem, too. And the engineers' technological approach to pollution isn't going to solve people problems.

Maybe this booklet can help. It lists some of the things all people can do to fight pollution. And with all the people supporting your engineers we'll have a better chance of winning the fight.

For a free copy or a list of bulk rates write to Keep America Beautiful, Inc., Box 1771, Radio City Station, New York, New York 10020.

Keep America Beautiful

Advertising contributed for the public good

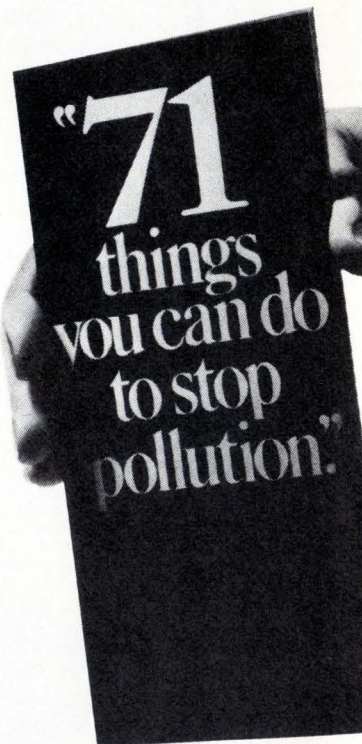

People start pollution.
People can stop it.

DATARAM SQUARES OFF AGAINST THE COMPETITION.

We're Dataram Corporation, the fastest-growing core memory company around, and the one to watch in the 16K single-board core memory market.

A look at the chart below will show you why . . . but if you want even more than specs from a company, consider this:

- Since the introduction of our 4K system in 1969, we've shipped thousands of 11.5" x 13.7" systems in our compatible 4K/8K/16K family.
- As the only company dedicated exclusively to core memory products, we make all of our own core, sell raw core to the outside market, string in high volume in three offshore locations, supply stacks to minicomputer manufacturers, maintain our own extensive manufacturing capability, and market a complete line of systems.

We're not alone in the 16K single-board core memory market. Familiar names like Ampex and EM&M are there too, but we can offer significant—and proven—performance and cost advantages. For more details, call Dataram at 609/799/0071. But don't take our word for it. Call Ampex (213/821/8933) and EM&M (213/644/9881) and hear their side of the story.

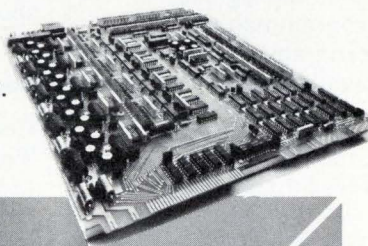

PICK THE WINNER.

16K Characteristic	Ampex 1600 Series	EM&M Micro 3000DD	Dataram DR-102
Cycle Time	650-900 ns	650 ns	850 ns (650 for compatible 8K x 20 DR-101)
Access Time	300-450 ns	300 ns	300 ns
Board Size	11.3" x 15.75"	11.75" x 15.4"	11.5" x 13.7"
DC Voltages Req'd.	2	3	2
Tolerances Req'd. on DC Voltages	±3% & ±5%	±3% & ±5%	±5%
Complete Component Accessibility	Yes	No	Yes
Maximum 16K Systems in Standard 5¼" Chassis	2	4	4
Other Compatible Sizes Available	8K	8K	4K, 8K
Standard Chassis Sizes	5¼" 12¼"	5¼" 12¼"	3½" 5¼" 12¼"

If you're looking for add-on memory for your Varian or Data General minicomputer, look to Dataram for high performance, low cost.



Princeton-Hightstown Road
Cranbury, N.J. 08512
609/799/0071

Pro-Log Eliminates Hard Wired Logic

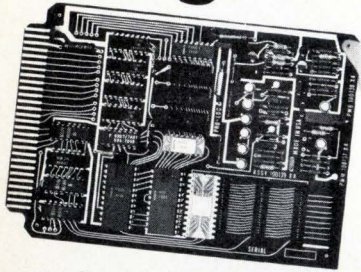

Our 4-bit microprocessor system can replace a rack full of your TTL chips. You'll save design time and production costs. No big redesign jobs for options or changes because the logic is stored in reprogrammable ROMs. Our programmed logic systems are available now, off the shelf.

Our PLS-401 microprocessor system costs less than \$400 in a quantity of one, with substantial OEM discounts. Plus we've got all the support you need: Design manuals, 2-day intensive design course, ROM Programmers, System Testors, special interface cards and support hardware to make your system go together smoothly.

and Mini Computers

Our MPS-800 microprocessor systems are modular production systems with mini-computer features such as: Expandable RAM, DMA, and 8 level priority interrupt. From under \$950 in a quantity of one with RAM. We have special interface cards and support hardware.

Micro Processor Systems from Pro-Log



852 Airport Road
Monterey, Calif. 93940
(408) 372-4593

New books

languages, and operating systems.

Chapter 5 is an overview of mini-computer systems, from a minimum configuration for process control, through stand-alone business and scientific computing, to a general-purpose real-time system. There are also sections on how to determine performance requirements, consideration of various alternatives, and the evaluation of systems.

The next two chapters are devoted to applications and the problems the user is likely to encounter and how he might overcome them. Finally there is a short chapter on future minicomputer systems, focusing on trends that will affect system design. There is also a section—too short—on microcomputers.

—Wallace B. Riley

Recently published books:

Communication Electronics for Technicians, Lloyd Temes, McGraw-Hill, 318 pp., \$10.95.

Principles of Heavy Current Engineering, Vol. 1, P.G. Lund and A.M. Howatson, Halsted Press, 115 pp., \$4.95 (paper).

Digital Theory and Experimentation Using Integrated Circuits, Morris E. Levine, Prentice-Hall, 227 pp., \$10.95 (paper).

Field-Effect Transistors In Integrated Circuits, J.T. Wallmark and L.G. Carlstedt, Halsted Press, 153 pp., \$13.50.

Cable Television—Acquisition and Operation of CATV Systems, Charles C. Woodard Jr., McGraw-Hill, 274 pp., \$27.50.

Organic Polymeric Semiconductors, Y. M. Paushkin, T.P. Vishnyakova, A.F. Lunin, and S.A. Nizova. (Translated from Russian), Halsted Press, 242 pp., \$25.00.

Gold Plating Technology, Frank H. Reid and William Goldie, Electrochemical Publications Ltd., Ayr, Scotland, 630 pp., \$53.50.

Industrial Electronics, N.M. Morris, McGraw-Hill, 376 pp., \$12.50.

The Measurement of Noise Performance Factors: A Metrology Guide, M.G. Arthur, NBS Monograph 142, U.S. Government Printing Office, SD Catalog No. C13.44:142, 188 pp., \$5.45.

Energy Saver



New Electronics Buyers' Guide... Easy-to-use, single volume source for:

- Information on over 4,000 products
- Over 6,000 company listings and phone numbers—both home and field offices
- EBG EXCLUSIVE: quick access to over 800 helpful catalogs through a timesaving Direct Inquiry Service
- More than 1,400 pages of data

Here is the international world of electronics at your fingertips. Find suppliers... fast... accurately... and locally! Don't have a copy? Use coupon below, today.

Electronics Buyers' Guide

A McGraw-Hill Publication
1221 Ave. of the Americas, N.Y. N.Y. 10020

Yes, send me _____ copies (copy) of the energy saving Electronics Buyers' Guide. I've enclosed \$15.00 (USA and Canada only; elsewhere send \$25.00). Full money back guarantee if not satisfied.

NAME _____

COMPANY _____

STREET _____

CITY _____

STATE _____ ZIP _____

Move up in performance, or down in price.



If you've been sacrificing oscilloscope specs for price, now you can move up in performance. Or, if you're used to high performance, you can keep it and pay less. Because HP's new 1720A has the specs you want at just \$3,400.* In fact, for less than the price of its nearest competitor, you can get the 1720A and still have money left over to buy an HP model 45 calculator, and a 970A probe digital multimeter.

This scope's 275 MHz bandwidth spec holds over the entire viewing area... on all deflection ranges... in both input impedance modes... whether the amplitude vernier is used or not... from 0 to 55°C.

Stable triggering lets you change

position, vernier, and polarity controls without losing sync. It triggers on low-level signals, yet refuses to double trigger on noise. And it triggers well beyond its bandwidth—often to 400 MHz or above.

Fast linear sweeps and a wide 10 cm screen give you high resolution for accurate high-speed digital timing measurements. Flood guns provide a display that's easy to view and photograph. And the logical layout of color-coded controls make this new high-speed scope a pleasure to operate.

Custom ICs and improved packaging provide a new dimension of simplicity in calibration and servicing (internal adjustments have been cut

about in half compared to other scopes in its class). And a lower component count means higher reliability—over 3,500 hours MTBF.

Any way you look at it—comparing features, or figuring cost of ownership—the 1720A gives you exceptional scope value. So move up in performance... or down in price, with HP's high-performance 1720A. Just contact your local HP field engineer. He'll also give you details on our new 200 MHz 1710B, at just \$2,625,* for field-service applications.

*Domestic USA prices only.

084/8

HEWLETT  **PACKARD**

Sales and service from 172 offices in 65 countries.
195 Page Mill Road, Palo Alto, California 94306

Circle 195 on reader service card

Opportunities in NORDEN'S Advanced Creative Environment

Because we are involved in projects that call for new approaches and techniques, we can offer you the opportunity to extend and maximize your special talents. Considering the growing sophistication of these projects, we think a strong potential exists to make significant professional contributions and find personal and professional satisfaction.

Coherent Radar Systems Specialist

Requires a comprehensive background in system and hardware aspects of airborne pulse Doppler radar. Will be responsible for management of technical proposals on coherent radar systems, identifying and monitoring related IR&D programs and technical support to marketing for new business opportunities. Advanced degree preferred.

Advanced Systems Engineer

Experience in research and analysis of airborne and ground electronic systems

such as air-to-air fire control, air-to-ground weapons control, air defense weapons systems. Duties will include development of systems specifications and conducting trade-offs and computer simulation to optimize design.

Sr. Sales Engineer

Requires minimum of 5 years experience in military avionics systems marketing. Specific experience in areas of radar, electro-optics or ECM systems desirable. Engineering degree required.

Electro-Mechanical Design Engineers

BS in Engineering and minimum 5 years experience. Responsible for evaluating requirements of functional specification to develop and establish analytical procedures and computer programs to solve unique design problems in vibration, strength of materials, heat transfer, weight and size reduction, and environmental operating conditions. Applications include airborne radar, displays, fire control systems and electro-optics.

Electro-Optics Engineers

Experience required in analysis, design and test of electro-optics equipment such as YAG lasers, CO₂ laser, detectors and modulators. BS degree in Engineering with a minimum of 7 years experience required.

Electronic Development Engineers

Advanced degree preferred. Experience in high speed digital processing systems required. Also terminals, alpha numeric or graphical display systems and associated communications systems; special and general purpose mini/micro computer control systems.

Please forward resume, including salary history to Mr. William H. McGuire, Norden, Division of United Aircraft, 310 Helen St., Norwalk, Conn., 06852.

Norden DIVISION OF **United Aircraft**

An Equal Opportunity Employer (M/F)



SEARCHLIGHT SECTION

- CLASSIFIED ADVERTISING
- BUSINESS OPPORTUNITIES
- USED OR SURPLUS EQUIPMENT

SAME DAY SHIPMENT
Minis & Peripherals

PRINTERS
"BRAND NEW"

DATA PRODUCTS

2440— 700 LPM

2470— 1250 LPM

MDS 4320— 300 LPM

ALSO
CENTRONICS, POTTER, CDC
A. B. DICK, IBM, HIS, UNIVAC
617/261-1100

Send for Free Report "Maintenance of Computers"
AMERICAN USED COMPUTER CORP.
P.O. Box 68, Kenmore Sta., Boston, MA 02215
member COMPUTER DEALERS ASSOCIATION

CIRCLE 951 ON READER SERVICE CARD

FREE CATALOG

HARD-TO-FIND PRECISION TOOLS
Lists more than 2000 items—pliers, tweezers, wire strippers, vacuum systems, relay tools, optical equipment, tool kits and cases. Also includes ten pages of useful "Tool Tips" to aid in tool selection.

JENSEN TOOLS
4117 N. 44th Street, Phoenix, Ariz. 85018

CIRCLE 953 ON READER SERVICE CARD

RADAR SYSTEMS TRACKING ANTENNA SYSTEMS

Nike Hercules, Nike Ajax, M-33, MPS-9, SCR-584, TPS-1E, TPS-28, FPS-6, FPS-14, FPS-18, FPS-75, UPX-6, MPQ-10A, IBM 705 Computers, HUNDREDS MORE. LARGEST INVENTORY OF RADAR AND MICROWAVE EQUIPMENT IN THE WORLD.

RADIO RESEARCH INSTRUMENT CO.
3 QUINCY ST., NORWALK, CONN. (203) 853-2600

CIRCLE 954 ON READER SERVICE CARD

FREE ALARM CATALOG

Full line of professional burglar and fire alarm systems and supplies. 96 pages, 450 items. Off the shelf delivery, quantity prices.

mountain west alarm
4215 n. 16th st., phoenix, az. 85016

CIRCLE 956 ON READER SERVICE CARD

DRY BOX SYSTEM

For sale: New ambient Dry Box System. A complete unit that can be used, requiring an environmentally controlled enclosure. Built for use in producing solid state components; at a cost of \$250,000. Still crated—47"; 7"; 4" Wt. 26,500 lbs. Constructed of stainless steel copper tubing. Includes all accessories. Price: \$50,000.

KC SALES CO.
319 S. W. Blvd. Kansas City, MO. 64108
(816) 471-2235

CIRCLE 957 ON READER SERVICE CARD

PROFESSIONAL SERVICES

Thorough Patent and Trademark Searches for Professional Engineers and Research & Development Firms. Patent Consultants, 422E Washington Building, Washington, D.C. 20005. (202) 638-1666.

Q. Whom do I contact or call to re-new my classified ad or make corrections?

A. Write Electronics, Class. Adv. Dept., P.O. Box 900, NY, NY 10020 or call: (212) 997-6585 or 6586. Give full company name, size of ad, & date or dates it is scheduled to appear.

free catalog
POTTING APPLICATORS
MANUAL OR AIR OPERATED
2 1/2cc 6cc 12cc 30cc
FOR POTTING, ENCAPSULATING ETC.

PHILIP FISHMAN CO., INC.
7 CAMERON ST. WELLESLEY, MASS. 02181

CIRCLE 952 ON READER SERVICE CARD

Editorial opportunities on ELECTRONICS

■ We're looking for a computer editor. The ideal candidate for this position will have an engineering degree, as well as extensive experience in the design of computers or computer-based systems and components. The candidate must, of course, bring writing ability to the job.

In covering the stimulating new developments in technology, our editors travel extensively, interview the people who make electronics the dynamic field it is, and write and edit technical articles.

As part of McGraw-Hill, one of the world's leading publishing companies, we offer excellent working conditions and fringe benefits. And, the salary level is as good as or better than industry rates for engineers.

■ In addition to a computer editor, we have an opening for an editorial trainee who is interested in combining an engineering education with a career in journalism. We'll train whomever we hire in all phases of technical reporting, writing, and editing, as practiced on ELECTRONICS, with a view to ultimate assignment as a department editor or field bureau reporter.

If you are interested in and have the necessary qualifications for either of these positions, send your résumé with salary requirements to: The Executive Editor, ELECTRONICS Magazine, 1221 Avenue of the Americas, New York, N.Y. 10020.

Energy Saver

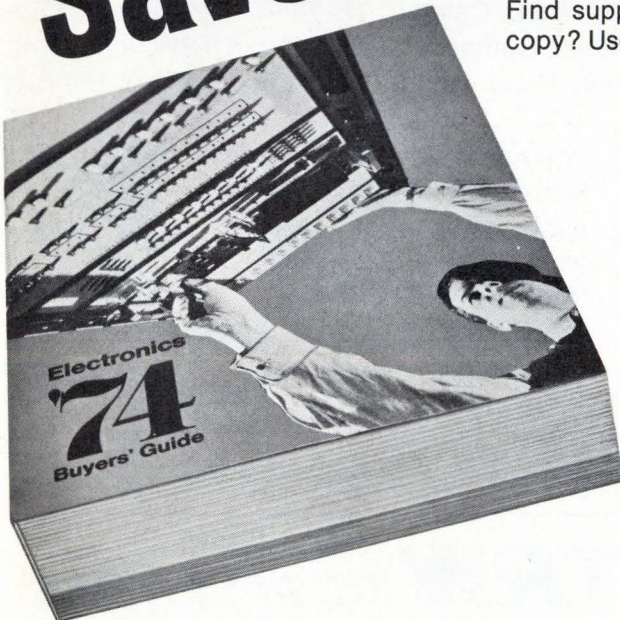

NEW Electronics Buyers' Guide Easy-to-use, single volume source for:

- Information on over 4,000 products
- Over 6,000 company listings and phone numbers—both home and field offices
- **EBG EXCLUSIVE:** quick access to over 800 helpful catalogs through a timesaving Direct Inquiry Service.
- More than 1,400 pages of data

Here is the international world of electronics at your fingertips. Find suppliers...fast...accurately...and locally! Don't have a copy? Use coupon, below.

Electronics Buyers' Guide

A McGraw-Hill Publication
1221 Ave. of the Americas • New York, N.Y. 10020

Yes, send me _____ copies (copy) of the energy saving Electronics Buyers' Guide. I've enclosed \$15.00 (USA and Canada only; elsewhere send \$25.00). Full money back guarantee if not satisfied.

NAME _____

COMPANY _____

STREET _____

CITY _____

STATE _____ ZIP _____

You know TRW for chassis and engine parts.

But do you know our resistor capability?

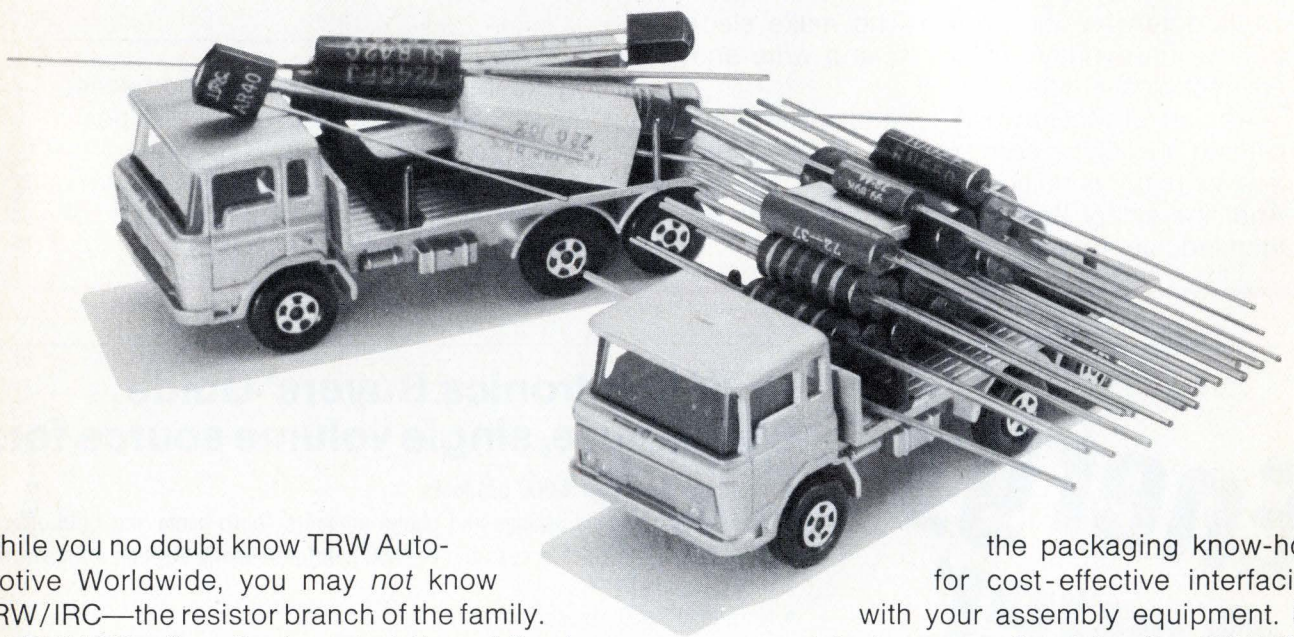

While you no doubt know TRW Automotive Worldwide, you may *not* know TRW/IRC—the resistor branch of the family.

TRW/IRC offers the broadest line of fixed resistors in the business—used by the *billions* in consumer, industrial, and military applications. This is a total resistor technology: carbon comp.'s, Metal Glaze™, wirewound, thin-film, networks, strips, and resistive functions for specific applications. We can give you *any* of the proven technologies, at reliability levels to meet automotive demands.

In fact, our resistors are already designed into automotive safety devices, electronic controls, ignition systems, fuel injection, adaptive brake systems and, of course, AM and FM radios, and mobile communications equipment.

TRW/IRC offers a high-volume, multi-source (four domestic plants) production capability. *Plus*

the packaging know-how for cost-effective interfacing with your assembly equipment. So get to know us. Send for the TRW/IRC Resistors Catalog. TRW/IRC Resistors, an Electronic Components Division of TRW, Inc., Greenway Road, Boone, N.C. 28607. (704) 264-8861.

TRW/IRC Fixed Resistors
Greenway Rd., Boone, N.C. 28607

**Please send your latest catalog
on TRW/IRC Resistors for
Automotive Applications**



Name _____ Title _____
Company _____
Address _____
City _____ State _____ Zip _____

TRW® IRC RESISTORS

Electronics advertisers

September 19, 1974

* Advanced Micro Devices Keye Donna Pearlstein	22E	Cramer Division of Conrac McCarthy, Scelba, DeBiasi Advertising Agency	42	■ General Electric Co., Semiconductor Products Department Advertising & Sales Promotion Syracuse Operation	30
Advanced Micro Devices Keye Donna Pearlstein	11	■ Dale Electronics, Inc. A Sub. of the Lionel Corporation Swanson, Sinkey, Ellis, Inc. Advertising	4th Cover	■ Gould, Inc./Instrument Systems Div. Carr Liggett Adv., Inc.	170
* AEROCOM Jacster Enterprises, Inc.	26E	■ Dana Laboratories Dailey & Associates	17-18	■ Gould Instrument Systems Marsteller, Inc.	181
Alrco Industrial Gases Gimbel, Hammond, Farrell & Walsh, Inc.	185	Data General Corporation Scali, McCabe, Sloves, Inc.	82-83	■ Grayhill, Inc. Stral Advertising Company, Inc.	6
■ Airpax Electronics, Inc. Robert B. Walker & Associates, Inc.	146	Dataram Corporation Louis Zimmer Communications	193	‡ Guardian Electric Mfg. Co. Kolb/Tookey and Associates, Inc.	60-61
■ Airpax Electronics Welch, Mirabile & Co., Inc.	45	‡ Delco Electronics Division, General Motors Corp. Campbell-Ewald Company	84-85	Hamamatsu Corporation Mandabach and Simms, Inc.	168
Allen Bradley Company Hoffman, York, Baker & Johnson, Inc.	26	■ Delevan Division, American Precision Industries, Inc. Comstock Advertising, Inc.	149	Harris Semiconductor Tucker Wayne & Co.	62-63
American Smelting and Refining Company Clyne Maxon, Inc.	184	Delta Air Lines Burke Dowling Adams, Inc.	192	■ Harshaw Chemical Co. Industry Advertising Company	175
■ AMP Incorporated Aitkin-Kynett Co., Inc.	24-25	Delta Products, Inc. The William Loughran Company	183	■ Heath/Schlumberger Scientific Instruments Advance Advertising Services	90-93
Amperex Electronic Corp. Sam Groden, Incorporated	10	Diacon Rogondino Advertising and Marketing	170	Hermes Electronics, Ltd. Public & Industrial Relations Limited	171
■ Analog Devices, Inc. Schneider Parker, Inc.	94	■ Dialight Corporation Michel-Cather, Inc.	2nd Cover	■ Hewlett-Packard Dancer Fitzgerald Sample, Inc.	162-163
* Anritsu Electric Co., Ltd. Diamond Agency Co., Ltd.	60	Digital Equipment Corporation Creamer, Trowbridge, Case & Basford, Inc.	152-153	■ Hewlett-Packard Richardson, Seigle, Rolfs & McCoy, Inc.	1
Ansley Electronics Corp. S. Michelson Advertising	182	Duncan Electronics, Inc. Sub. of Syston Donner Corp. Enyart & Rose Advertising, Inc.	23	■ Hewlett-Packard Tallant/Yates Advertising, Inc.	2
Associated Environmental Systems, Inc. A.D. Adams Advertising, Inc.	172	Eastern Air Devices Weston Associates, Inc.	180	■ Hewlett-Packard Bozell & Jacobs/Pacific	73
Astro-Med Michael London Associates	156	Efratom of California, Inc.	160	■ Hewlett-Packard Tallant/Yates Advertising, Inc.	195
■ AVX Ceramics TCI Advertising, Inc.	77-79, 81	■ Electronic Navigation Industries Hart/Conway Advertising— Public Relations	14	Hybrid Systems Corporation Henry Scammell Associates	176
Ballantine Laboratories, Inc. MLF Graphics	166	Emr-Telemetry Carol Marketing Associates	121	Individualized Instructions, Inc. Jordan Associates	78
‡ Baron Blakeslee Kolb/Tookey & Associates, Inc.	134-135	■ Erie Technological Products, Co., Inc. Altman Hall Associates Advertising	19	* Industrie Bitossi s.a.s.	44
* Bayer A.G. Werbeagentur	134	‡ Excellon Industries Graham & Sparkman Advertising etcetera	132	Instrumentation Engineering Inc. Fletcher-Walker-Gessell Inc.	131
‡ Beckman Instruments, Inc., Helipot Division N.W. Ayer/Jorgensen/MacDonald, Inc.	139	Fabri-Tek Inc. Midland Associates, Inc. Marketing and Advertising Services	129	Intel Corp. Regis McKenna, Inc.	20-21
* Beckman Instruments Ltd.	13E	Fairchild Camera & Instrument (Systems Technology Div.) Rose Associates Advertising and Public Relations	201	* International Automation and Instrumentation Conference and Exhibition Studio Bla	19E
Brand-Rex Creamer, Trowbridge, Case & Basford, Inc.	39	Fairchild Semiconductor, Inc. Carson/Roberts, Inc. Adv., Division of Ogilvy & Mather, Inc.	164-165	International Electro Exchange Fischbein Advertising, Inc.	141
■ Cambridge Thermionic Corporation Chirurg & Cairns, Inc.	172	* Gardner-Denver Co. Buchen Advertising, Inc.	132	■ Interstate Electronics Corp. Chris Art Studio, Inc.	166, 168
‡ The Carborundum Company Stahika/Faller, Inc.	59	■ General Instrument Corporation, Semiconductor Comp. Div. Norman Allen Associates, Inc.	53	* Invest Export-Import Interwerbung	21E
Cinch Connectors, Operation of TRW Electronic Components Stral Advertising Company, Inc.	137	■ General Electric Co., Miniature Lamp Div. Carr Liggett Advertising, Inc.	138	IPT Corporation Rock Advertising Design	8
Computer Automation Cochrane Chase & Company, Inc.	64-65			■ Ithaco, Inc. Webb & Athey, Inc.	169
■ Cornell Dubilier Electronics McCarthy, Scelba, DeBiasi Advertising Agency, Inc.	41, 43			Krohn-Hite Corp. Impact Advertising, Inc.	5

Litronix, Inc. Bonfield Associates	12-13	* Procond S.p.A. Quadrangolo	10E	■ Tektronix, Inc. McCann-Erickson, Inc.	35, 150-151, 189
Lockheed Electronics Co. McCann-Erickson, Inc.	158	Pro-Log Corporation Kassler Noble Advertising	194	* Teledyne Relays S. Michelson Advertising	61
Macrodata Company JMR Advertising	143	Pulse Engineering Manning/Bowen and Associates	204	Teledyne Semiconductor Regis McKenna, Inc.	7
* Marconi Instruments Ltd. Russell Powell Advertising Ltd.	7E	‡ Raytheon Company, Sorensen Department Provandie Eastwood & Lombardi, Inc.	44	Teletype N.W. Ayer & Son, Inc.	203
McGraw-Hill Book Company	188	■ Raytheon Company, Industrial Components Operation Provandie Eastwood & Lombardi, Inc.	140	Teradyne, Inc. Quinn & Johnson, Inc.	66
The Mica Corporation Robert A. White Advertising	179	Raytheon Company, Production Equipment Department Provandie Eastwood & Lombardi, Inc.	6	Texscan Corporation Bruce Bottum Associates	148
Monsanto Commercial Products Co., Electronic Special Products Advertising Promotion Services	177	* RCA Electronic Components Al Paul Lefton Company, Inc.	113	Thomson CSF Bazaine Publicite	174
Mostek Corporation David W. Evans, Inc./Texas	15	RCA—Solid State Division Marsteller, Inc.	69, 71	■ TRW/Capacitors Gray & Roger, Inc.	173
* Motorola Semiconductor Graham & Gillies Limited	11E	‡ Rental Electronics, Inc. Humphrey Browning MacDougall, Inc.	56	■ TRW—UTC Transformers The Bowes Company	161
Motorola Semiconductor Products, Inc. E B Lane & Associates, Inc.	48-49	* Rohde & Schwarz	1E	■ TRW Semiconductors The Bowes Company	88-89
National Electronics Lea Advertising	80	Sangamo Electric Co. Batz - Hodgson - Neuwoehner, Inc.	187	■ TRW/IRC Resistors Gray & Rogers, Inc.	198
■ National Semiconductor Corp. Chiat/Day, Inc. Advertising	37	Schauer Manufacturing Corp. Nolan, Keelor & Stites	186	* Ultra Dennis Dolling Limited	23E
■ National Semiconductors Limited Griener Harries Maclean Ltd.	158	* S.E. Labs (EMI) Ltd. Graphic Publicity Ltd.	14E-15E	■ Unitrode Corporation Culver Advertising, Inc.	29
Neff Instruments Corp. Larry Courtney Company	3rd Cover	* Sescosem Bazaine Publicite	4E	Universal Instrument Corp. Conklin, Labs & Bebee, Inc.	47
NEREM Drumbeater	72, 184	* Siemens A.G. Munich Linder Presse Union GmbH	54	U.S. Capacitor Corp. S. Michelson Advertising	167
North Atlantic Industries, Inc. NOAT Advertising Company	178	‡ Siemens Corp.—Electronic Systems Division, Computest Products JL Associates	113	Vero Electronics, Inc. Rama Advertising	204
* Nortron Technik Marketing	24E	* Silec Societe Mexim	28E	Victoreen Instruments Division Dix & Eaton, Inc.	157
* Nuovo Pignone Attivita Pignone Sud Linea Spn	16E	Simpson Electric Co. Amerad Advertising Services, Inc.	159	* Wandel und Goltermann Werbeagentur	27E
* Oscilloquartz SA, Neuchatel Publicitas	8E-19E	* SMK Europe	12E	Western Digital Corporation W D C Advertising	86-87
* Philips Elcoma Intermarco Nederland	9E	Sound Technology Frank Burkhard Company	154	■ Woven Electronics Prentiss Court Advertising	22
* Philips Electrologica Intermarco Nederland	59	Spectra Physics Regis McKenna, Inc.	147	* La Zincocelere S.p.A. Studio Dr. Giuliano Blei	25E
* Philips Industries Vaz Dias	2E-3E	Spectrol Electronics Corp. J M R Inc.	145	Classified & Employment Advertising F. J. Eberle, Manager 212-997-2557	
* Philips N.V. Pit/T & M Division Brockies Communications Systems SA	56	Sprague Electric Company Harry P. Bridge Company	16	EQUIPMENT (Used or Surplus New) For Sale	
Phoenix Data, Inc. Craig Miller Advertising	202	Systron Donner Concord Instruments Fred Schott & Associates	9, 160	American USED Computer Corp.196	
■ Piezo Technology, Inc. Shattuck/Roether, Advertising, Inc.	190	Tally Corporation Bonfield Associates	182	Phillip Fishman Co., Inc.196	
Plessey Incorporated TCI Advertising, Inc.	191	* TEAC Corp. Dentsu Advertising	139	K C Sales Co.196	
Princeton Electronic Products, Inc. Mort Barish Associates, Inc.	142	■ TEC, Inc. TEC-AD	50	Mountain West Alarm196	
				Norden Div. of United Aircraft196	
				Radio Research Instrument Corp.196	
				<ul style="list-style-type: none"> ■ For more information on complete product line see advertisement in the latest Electronics Buyer's Guide * Advertisers in Electronics International ‡ Advertisers in Electronics domestic edition 	

"When engineers saw they didn't have any knobs, they were scared they'd lose control, but now they're in love with the thing."

So happy, indeed, that when AMI offered to brief our people on their side of the story, we asked if we could publish some of their comments. They're reproduced here.

The validity of their comments? Each uses Sentry 600, relies on Sentry 600, and has one or more Sentry 600 systems in their department: Ed Carcher, Manager of Product Characterization; George Gray, Manager,

Test; Bill McNeally, Supervisor, Test; Bob Frohman, Supervisor, Systems Software Support; Fred Jenne, Director of Advanced Product Development.

"You'd need a wall full of knobs to let them do slowly what S-600 does fast."

"We have yet to find a device we couldn't test on the Sentry 600."

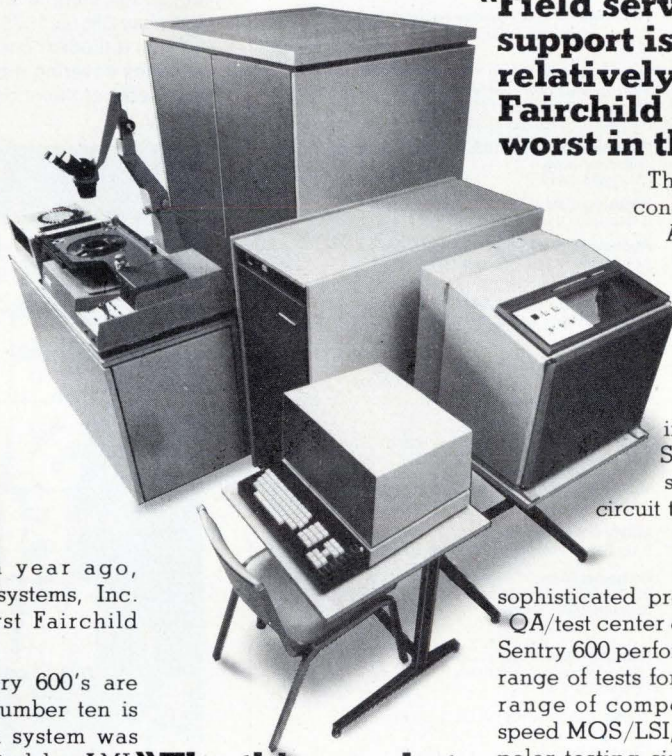

"Field service and support is very good, relatively speaking. Fairchild is the least worst in the industry."

They know semiconductor testing. And they know the Sentry 600.

The Sentry 600. Just one function-optimized component in the Fairchild Sentry family of six interrelated circuit testing systems.

Optimized for engineering, sophisticated production, and QA/test center operations, the Sentry 600 performs the widest range of tests for the broadest range of components. High speed MOS/LSI, PCB and bipolar testing simultaneously. Complete testing at wafer level and in automatic handlers at full rated device speeds. Finally, and most important to

AMI, extensive peripheral choice for massive data generating capacity. Manipulate. Analyze. Compute.

But don't take our word on it.

Listen to AMI: "When we went to buy a system, we could buy anything we wanted. We were not restricted by what the rest of the company had. We made an evaluation and chose the Sentry 600. It lived up to expectations fully."

AMI's experience: It's a good reason to check into Fairchild Sentry systems. Because it's time you had a semiconductor test system that lives up to your needs and expectations.

Fairchild Systems, A Division of Fairchild Camera and Instrument Corporation, 1725 Technology Drive, San Jose, California 95110. (408) 998-0123 TWX: 910-338-0558.

MADE IN
FAIRCHILD

Slightly over a year ago, American Microsystems, Inc. ordered their first Fairchild Sentry 600.

Today, nine Sentry 600's are on line at AMI. Number ten is on its way. Each system was carefully evaluated by AMI. And then the next ordered. The result? AMI is now the largest purchaser of Fairchild's Sentry 600. It's a happy association.

"The thing we hate most about it is the thing we love most about it!"

"Without the Sentry I would never even try to get this type of data."

"One insertion goes through 50 different tests — we are checking parameters, not making Go/No-Go tests."

NEW
and
EXCLUSIVE
an
A/D Converter
from
PHOENIX DATA
with

High Speed: 4 usec.
(250,000 conversions per sec.)
High resolution: 15 bits
High accuracy: 0.0065% of FSR

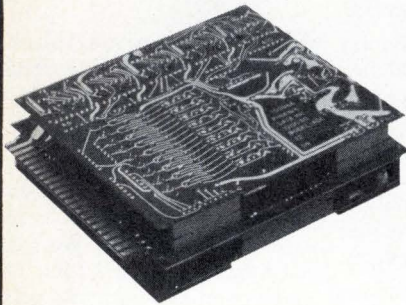

New Model ADC1215F converter from Phoenix Data is available in two basic models: Single-ended and differential.

Phoenix Data's new Model ADC1215F A/D converter has a resolution of 15 binary bits and a total conversion time of 4 microseconds (250,000 conversions per sec). Accuracy of 0.0065% of FSR is **guaranteed** in addition to complete monotonicity. Analog dynamic range is in excess of 86 db.

If it's stability, accuracy, speed, or all-around quality you need in Data Conversion, contact Phoenix Data now!



PHOENIX DATA, INC.

3384 W. Osborn Rd. Phoenix, AZ 85017
Ph. (602) 278-8528, TWX 910-951-1364

Advertising Sales Staff

Pierre J. Braudé New York [212] 997-3468
London 01-493-1451
Director of Marketing

Atlanta, Ga. 30309: Joseph Lane
100 Colony Square, 1175 Peachtree St., N.E.
[404] 892-2868

Boston, Mass. 02116: James R. Pierce
607 Boylston St. [617] 262-1160

Chicago, Ill. 60611:
645 North Michigan Avenue
Robert W. Bartlett (312) 751-3739
Paul W. Reiss (312) 751-3738

Cleveland, Ohio 44113: William J. Boyle
[716] 586-5040

Dallas, Texas 75201: Charles G. Hubbard
2001 Bryant Tower, Suite 1070
[214] 742-1747

Denver, Colo. 80202: Harry B. Doyle, Jr.
Tower Bldg., 1700 Broadway
[303] 266-3863

Detroit, Michigan 48202: Robert W. Bartlett
1400 Fisher Bldg.
[313] 873-7410

Houston, Texas 77002: Charles G. Hubbard
2270 Humble Bldg. [713] CA 4-8381

Los Angeles, Calif. 90010: Robert J. Rielly
Bradley K. Jones, 3200 Wilshire Blvd., South Tower
[213] 487-1160

New York, N.Y. 10020
1221 Avenue of the Americas
Warren H. Gardner [212] 997-3617
Michael J. Stoller [212] 997-3616

Philadelphia, Pa. 19102: Warren H. Gardner
Three Parkway,
[212] 997-3617

Pittsburgh, Pa. 15222: Warren H. Gardner
4 Gateway Center, [212] 997-3617

Rochester, N.Y. 14534: William J. Boyle
9 Greylock Ridge, Pittsford, N.Y.
[716] 586-5040

San Francisco, Calif. 94111: Don Farris
Robert J. Rielly, 425 Battery Street,
[415] 362-4600

Paris: Alain Offergeld
17 Rue-Georges Bizet, 75 Paris 16, France
Tel: 720-73-01

Geneva: Alain Offergeld
1 rue du Temple, Geneva, Switzerland
Tel: 32-35-63

United Kingdom & Scandinavia: Keith Mantle
Tel: 01-493-1451, 34 Dover Street, London W1

Milan: Robert Saidel
1 via Baracchini, Italy Phone 86-90-656

Brussels: Alain Offergeld
23 Chaussee de Wavre
Brussels 1040, Belgium
Tel: 13-73-95

Frankfurt/Main: Fritz Krusebecker
Liebigstrasse 27c, Germany
Phone 72 01 81

Tokyo: Tatsumi Katagiri, McGraw-Hill
Publications Overseas Corporation,
Kasumigaseki Building 2-5, 3-chome,
Kasumigaseki, Chiyoda-Ku, Tokyo, Japan
[581] 9811

Osaka: Ryji Kobayashi, McGraw-Hill
Publications Overseas Corporation, Kondo
Bldg., 163, Umegae-cho Kita-ku, Japan [362] 8771

Australasia: Warren E. Ball, IPO Box 5106,
Tokyo, Japan

Business Department

Stephen R. Weiss, Manager
[212] 997-2044

Thomas M. Egan,
Production Manager [212] 997-3140

Carol Gallagher
Assistant Production Manager [212] 997-2045

Dorothy Carter, Contracts and Billings
[212] 997-2908

Frances Vallone, Reader Service Manager
[212] 997-6057

Electronics Buyers' Guide

George F. Werner, Associate Publisher
[212] 997-3139

Regina Hera, Directory Manager
[212] 997-2544

**Exclusive
Economic and
Industry Studies**

**For Financial Analysts,
Corporate Planners,
Business Economists,
Marketing Executives**

Geared directly to the future, our Department of Economics offers more than 40 forecasting tools to help project the general economy and industrial growth over the short and long run.

EXAMPLES: Do you know that the current operating rate for the chemical industry is 86%? For synthetic materials, the utilization rate is 93%? That construction and mining machinery new orders are expected to be 8% higher in 1974 than in '73? That steel expects a 3% decline in physical volume of sales in 1974? That consumer income after taxes will increase 8% in 1975?

At a modest cost, our various services covering most industrial segments of the economy are available to you.



For more information write for our booklet, "Exclusive Economic Studies," or phone Douglas Greenwald, Chief Economist, (212) 997-2216.

Department of Economics
McGraw-Hill Publications Company
1221 Avenue of the Americas
New York, N.Y. 10020



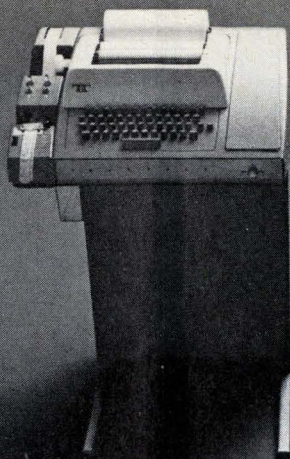

The model 33 is so good you'll never believe its price.

Underneath the cover of the model 33 is a data terminal that offers the most in reliability and versatility at a very economical price.

In fact, you can't buy a terminal that offers as much as the model 33 does—for as little as the model 33 costs.

That was true when we introduced the model 33. And it's still true today. Although the terminal we're selling today is hardly the terminal we started with. That's because over the years we've had a crack team of engineers assigned to the model 33. And their only job is to search out ways to improve it.

Some of their improvements have made the model 33 more

reliable and rugged. Others have kept the cost down.

But as improved as the model 33 is, the changes haven't outmoded previous model 33's. So the oldest unit still putting in a hard day's work is compatible with the units coming off our assembly lines right now.

However, there is one small part of the model 33 we're trying to keep as old-fashioned as possible. That's the price. We want to make sure our customers get more than a data terminal. By making sure they also get a bargain.

It takes more than manufacturing facilities to build the terminals Teletype® Corporation offers. It also takes commitment. From people who think service is as important as sales. In terminals for computers and point-to-point communications.



The computercations people.

For more information about any Teletype product, write or call: TERMINAL CENTRAL, Teletype Corporation, Dept. 53T, 5555 Touhy Avenue, Skokie, Illinois 60076. Phone 312/982-2500. Teletype is a trademark registered in the United States Patent Office.

Circle 203 on reader service card

MINIATURE PULSE TRANSFORMERS

CHECK THE USES FOR OFF-THE-SHELF AND CUSTOM DESIGNS

APPLICATIONS	TRANSFORMER TYPE			
	Dip	General Usage	Inverter	Open Coil
Circuit Isolation to 200 VDC	✓	✓		✓
Circuit Isolation to 500 VDC		✓		
DC/DC Converters			✓	
Memory Drive Balance	✓	✓		✓
Memory Drive Floating Switches	✓	✓		
Pulse Coupling to 1 μ sec	✓	✓		✓
Pulse Coupling to 10 μ sec		✓		
Sense Line Balance	✓			✓
Sense Line CMR	✓	✓		✓

With 15 years of miniature magnetic experience, Pulse Engineering can offer a large variety of pulse transformers for your applications.

STOCK ITEMS INCLUDE:

- DIP TRANSFORMERS
- CONTROL TRANSFORMERS
- GENERAL USAGE TRANSFORMERS
- SHIELDED GENERAL USAGE TRANSFORMERS
- LINE DRIVE AND RECEIVE TRANSFORMERS
- INVERTER TRANSFORMERS
- OPEN COIL TRANSFORMERS

CUSTOM DESIGNS AND MODIFICATIONS OF THE ABOVE AVAILABLE FOR LARGE VOLUME REQUIREMENTS.

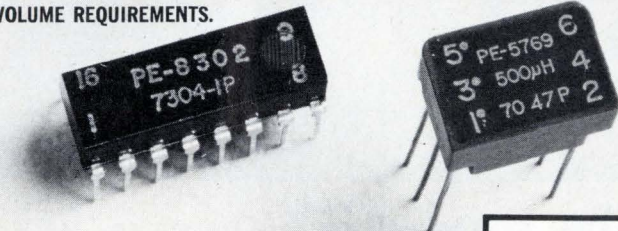

P. O. Box 12235
San Diego, California 92112
Phone 714-279-5900
TWX 910-335-1527

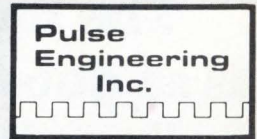

Circle 204 on reader service card

VERO ... A COMPLETE ELECTRONIC PACKAGING CAPABILITY

Frames and Module Racks

A total and versatile packaging capability for every application from a connector to a case ... and everything in between!

- Standard EIA Rack Mounting, 5.25", 7", 8.75" panel heights
- 10" and 13" deep end plates
- 1", 2", 4", 5", 6", and 8" wide modules
- All modules can be fully screened
- Verolock® system retains all modules with one push/pull action
- Extremely rigid construction
- FREE design service to your specifications
- Off-the shelf delivery

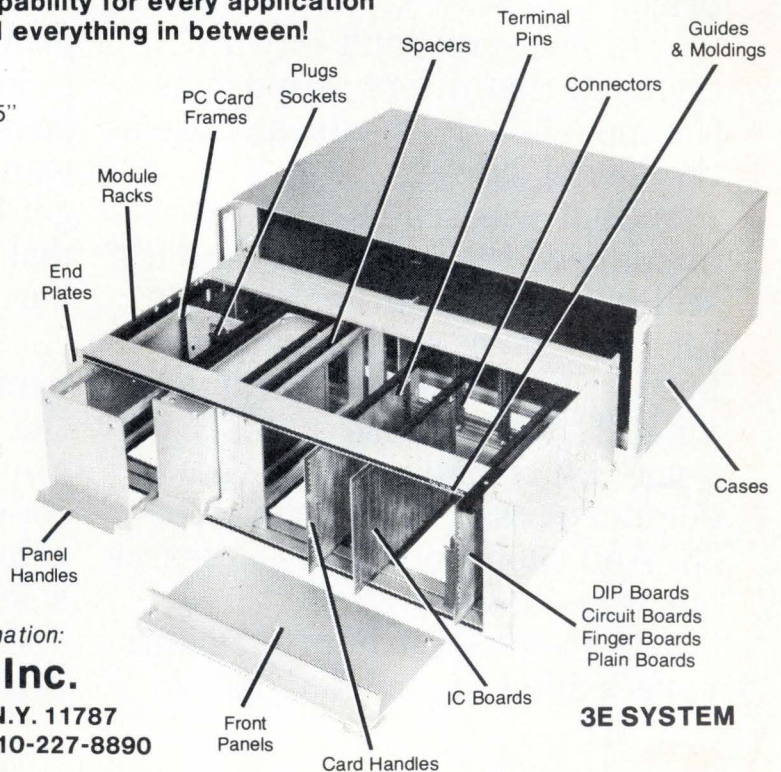

We make your job easier...

Call or write today for more information:

Vero Electronics, Inc.

171 Bridge Road, Hauppauge, N.Y. 11787
Tel.: 516-234-0400 TWX: 510-227-8890
In Canada Call: EPS, 613-389-1025

3E SYSTEM

204 Circle 226 on reader service card

Electronics/September 19, 1974