

OCTOBER 31; 1974

Modeling the bipolar transistor, part 2/71

Computerized radar system guards busy harbor/82

Thermal design, part 9: thermal resistance of ICs/87

STATE TECHNICAL INSTITUTE
AT MEMPHIS

FOUR DOLLARS A MCGRAW-HILL PUBLICATION

Electronics®

EXTENDING
THE
FINE ART
OF
LINEAR ICs

1420 TCH598 MCSA9 JUN75
STATE TECHNICAL INSTITUTE
MS NF WALKER
5983 MACON COVE
MEMPHIS TN
38134



We're the most modern CMOS facility in the business, and the second biggest producer.

Doesn't that tell you something about quality and delivery?

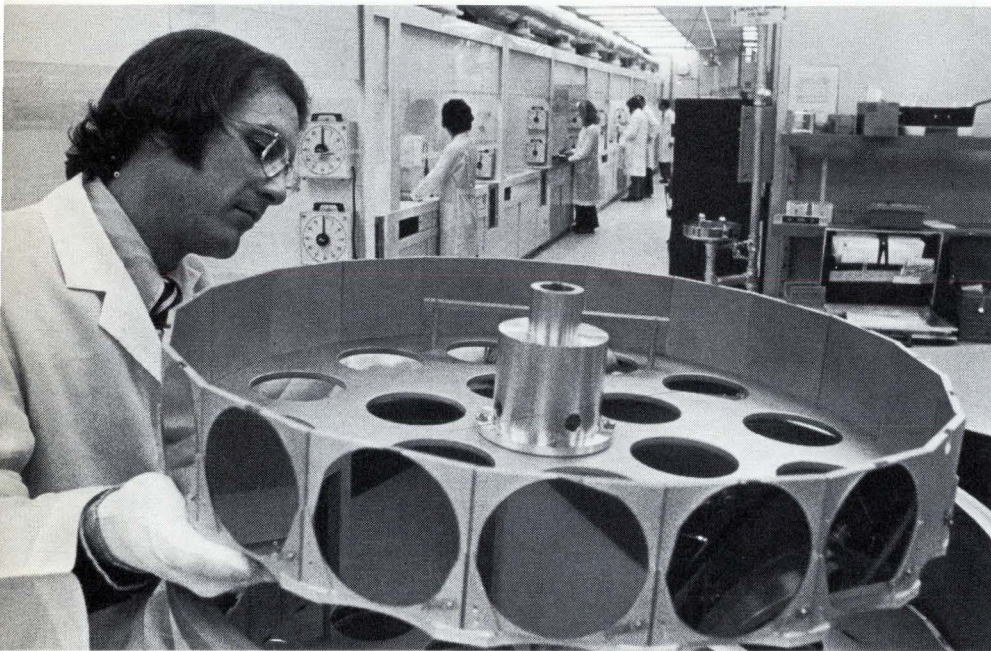

Ion implantation

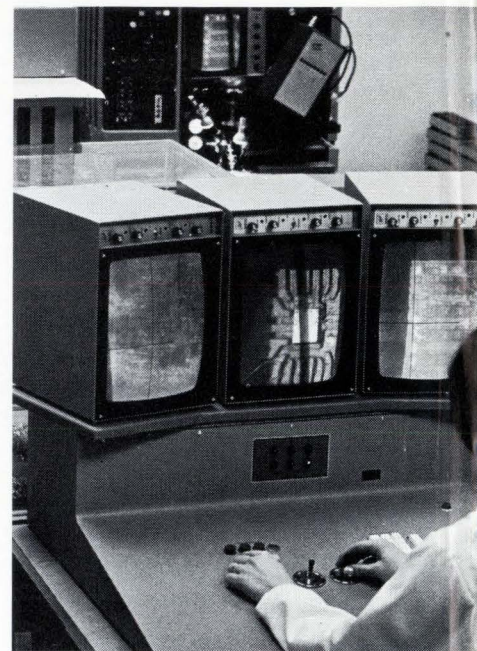

Automatic wire bonding

It should. We're the most modern because we've grown at a phenomenal rate. So our entire facility is the newest and finest and most productive that money can buy. Which means top quality and excellent delivery.

Capacity is up 500% in the last two years alone.

So we're a fairly close number two to RCA right now. And gaining.

How come such growth? Because we specialize in CMOS. We concentrate on production of the most popular types. Anybody's types.



Computer controlled testing

We have a lot more going for you. The prime CMOS facility in the country. The sharpest technical people in the business. And state-of-the-art equipment like a brand new three-inch wafer facility, ion implantation, automatic wire bonding, computer-controlled testing.

So if you want CMOS, and you want consistent quality and availability, talk with us soon. Meanwhile, let us send you our new catalog. Just write "CMOS" on your business card, and mail it to us. Or call our nearest sales office.

East: 215-279-8424
Midwest: 312-437-8343
West: 408-247-9470



SOLID STATE SCIENTIFIC INC.

Montgomeryville, Pa. 18936 / (215) 855-8400 / TWX 510-661-7267

The alternate source that's better than equal.

Circle 900 on reader service card

Now HP has a compact 8½ x 11 XY recorder that's made to measure for OEMs.

Like
this.

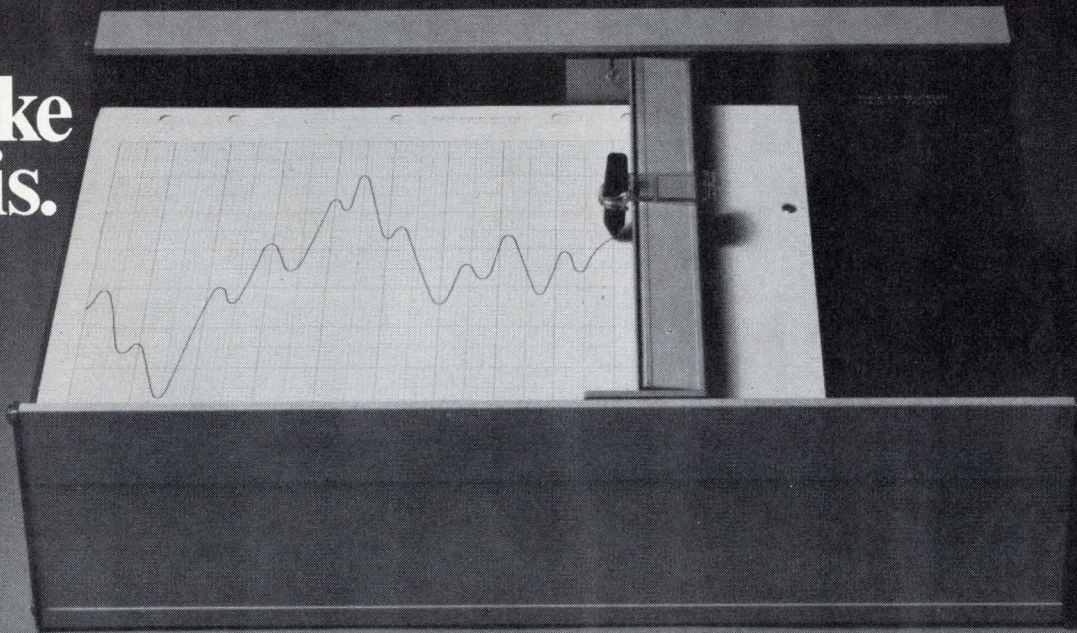

This.

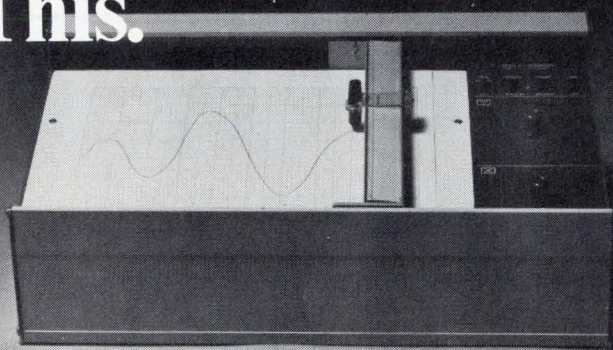

Or this.

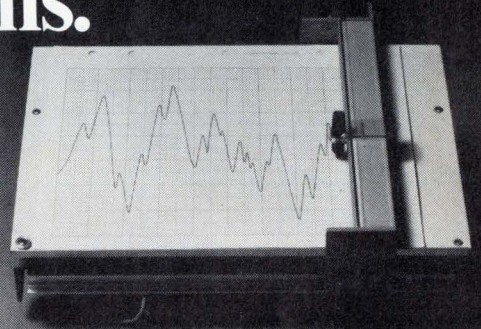

You'll find that Hewlett-Packard's new 7010A XY recorder puts the features most important to OEMs into one economical package.

It's sized for crowded racks and consoles.

Custom tailoring gives you just the recorder you need, without putting a dollar into extras you won't use.

And HP's reputation for performance and dependability adds unmistakable value to your system.

You can order a 7010A in any of three basic models.



Price is in the \$900 range (domestic USA only) with OEM discounts available. In a bench top or rack unit, the recorder comes with a blank panel ready for the addition of controls after delivery. Or, you can have controls factory installed. A version with stripped chassis is designed for mounting in a 10 x 13 opening in your console. All three configurations have 100 mV/div scaling and several options to equip the recorder for your specific needs. You can have 10 mV/div or 1 V/div sensitivity,

electric pen lift, metric scaling, single range time base and carrying case. Rugged, continuous duty servo motors can be run off-scale for hours without damage. Standard features include electrostatic paper holddown and mechanical pen lift. We supply high quality disposable fiber tipped pens along with a universal holder designed to fit a variety of other brands.

Get details on the new 8½ x 11 7010A XY recorder. It gives you a choice of models made to measure for OEM systems. With a full measure of HP dependability. Write Hewlett-Packard, 1501 Page Mill Road, Palo Alto, CA 94304.

11412

HEWLETT  PACKARD

Sales and service from 172 offices in 65 countries.
1501 Page Mill Road, Palo Alto, California 94304

Circle 1 on reader service card

Handle Troublesome Signals Easily With HP Variable-Persistence Scopes.



Because the unique capabilities of variable persistence in HP's 180 systems tackle these difficult measurement problems with much more ease than the conventional scope you're probably now using.

Dim traces—low rep-rate signals are brightened by the integrating characteristics of variable persistence so you can observe them clearly in normal ambient light...even at rep-rates below 1 Hz.

Transients—digital noise pulses or other single-shot events are made visible by the high writing speed of HP's mesh-type storage and variable persistence.

Slow-moving waveforms—electromechanical events or transducer outputs that appear as a "bouncing ball" on conventional scopes will be displayed as a continuous trace with variable persistence, allowing more accurate voltage

and timing measurements.

Two storage mainframes give you a choice of writing speeds. And a broad selection of plug-ins lets you tailor your scope to meet specific needs. To get the maximum performance for your storage-scope dollar, look to HP.

For more information about the 180 system, contact your local HP field engineer. Or, write Hewlett-Packard, 1501 Page Mill Road, Palo Alto, California 94306.

084/3

HEWLETT  PACKARD

Sales and service from 172 offices in 65 countries.
1501 Page Mill Road, Palo Alto, California 94306

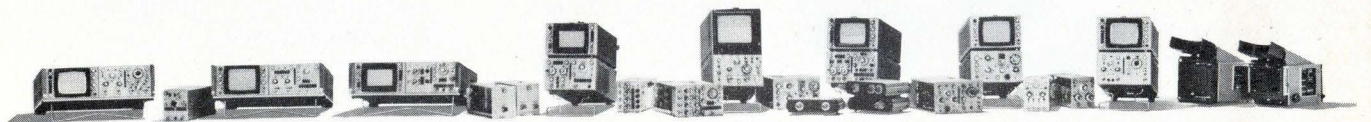

25 Electronics Review

COMPUTERS: DEC meets micro challenge with three-chip mini, 25
PACKAGING & PRODUCTION: Conductive elastomers expand role, 26
BUSINESS: Semiconductor outlook flat for 1975, 27
AVIONICS: Cockpit voices are for pilot's good, 27
MEMORY: Mass store holds 4 trillion bits, 28
CONSUMER: Texas Instruments defers its watch market entry, 29
SOLID STATE: CCD image array gets its own amplifier, 30
DISPLAYS: Thin-film transistor array triggers display, 32
NEWS BRIEFS: 32
COMMUNICATIONS: Newspaper facsimile transmitted via satellite, 34

44 Electronics International

INTERNATIONAL: Interkama reflects optimism for process control, 44
GREAT BRITAIN: Agency aims CCDs at radar functions, 44
AROUND THE WORLD, 45

51 Probing the News

AVIONICS: MLS nears decision, 51
COMMERCIAL ELECTRONICS: Solar energy R&D gets a boost, 54
Calculator-chip business slows, 56
PACKAGING & PRODUCTION: Pc-board changes may mean woes, 62

65 Technical Articles

SOLID STATE: Bipolar-MOS process improves linear-IC specs, 65
CIRCUIT DESIGN: Part 2, Modeling the bipolar transistor, 71
DESIGNER'S CASEBOOK: Phase modulation attains 100 MHz, 78
Single switch regulates number of pulses, 80
NAVIGATION: Monitoring ship traffic in San Francisco Bay, 82
CIRCUIT DESIGN: IC thermal characteristics gain importance, 87
ENGINEER'S NOTEBOOK: Amplifier provides variable ac power, 92
Two circuits indicate synchro shaft position, 92
Convert coordinates and find SWRs graphically, 94

99 New Products

IN THE SPOTLIGHT: Microprocessor directs wafer-prober, 99
INSTRUMENTS: Pulse generator checks high-speed logic, 100
SEMICONDUCTORS: D-MOS process is applied to ICs, 102
DATA HANDLING: Cathode-ray-tube terminal is ruggedized, 104
PACKAGING & PRODUCTION: Bayonet plug resists vibration, 107

Departments

Publishers letter, 4
Readers comment, 6
40 years ago, 8
People, 14
Meetings, 17
Electronics newsletter, 19
News update, 38
Washington newsletter, 41
Washington commentary, 42
International newsletter, 47
Engineer's newsletter, 97

Highlights

Cover: The new high-frequency linear-IC picture, 65

Another advance in bipolar processing, combined with several of the latest MOS techniques, allows linear ICs to be built that perform well on ac as well as dc parameters. Even the 10-nanosecond data acquisition range is within their reach. Cover was designed by Art Director Fred Sklenar and photographed by Ann Dalton.

Calculator-chip makers seek new markets, 56

Because consumers are buying fewer calculators, manufacturers of MOS chips are being forced to search out other applications, chiefly memories and microprocessors.

Harbor system will help ships avoid collision, 82

If present tests prove successful, an all-weather computerized radar and radio communications system will soon enable operators to track all ship movements in San Francisco Bay on real-time displays.

How to estimate an IC's thermal resistance, 87

Today's chips and boards are so densely packed that knowledge of an IC's thermal resistance is often vital to successful system design. Part 9 of the Thermal Design series discusses why an IC heats up and how to estimate the degree to which it will heat up.

And in the next issue . . .

Designing with the universal instrument interface . . . analog signal processing with charge-coupled devices . . . update on temperature transducers.

EDITOR-IN-CHIEF: Kemp Anderson

EXECUTIVE EDITOR: Samuel Weber

MANAGING EDITORS: Lawrence Curran, *News*;
Arthur Erikson, *International*

SENIOR EDITORS: John Johnsrud,
H. Thomas Maguire, Laurence Altman,
Ray Connolly, Stephen E. Scrupski

ART DIRECTOR: Fred Sklenar

ASSOCIATE EDITORS: Howard Wolff,
Gerald M. Walker, Alfred Rosenblatt

DEPARTMENT EDITORS
Aerospace/Military: Ray Connolly
Circuit Design: Wallace B. Riley
Communications & Microwave:
Stephen E. Scrupski
Components: Lucinda Mattera
Computers: Wallace B. Riley
Consumer: Gerald M. Walker
Industrial: Margaret A. Maas
Instrumentation: Andy Santoni
New Products: H. Thomas Maguire,
Michael J. Riezenman
Solid State: Laurence Altman

COPY EDITORS: Margaret Eastman,
Everett C. Terry, Bill Dunne

ART: Charles D. Ciatto, *Associate Director*
Patricia Cybulski, *Assistant Director*

PRODUCTION EDITOR: Arthur C. Miller

EDITORIAL SECRETARIES: Janet Noto,
Julie Gorgoglione, Penny Roberts

FIELD EDITORS

Boston: Gail Farrell
Los Angeles: Paul Franson (Mgr.)
Midwest: Larry Armstrong (Mgr.)
New York: Ron Schneiderman (Mgr.)
San Francisco: Bernard Cole (Mgr.)
Judith Curtis
Washington: Ray Connolly (Mgr.)
Larry Marion
Frankfurt: John Gosch
London: William F. Arnold
Paris: Arthur Erikson
Tokyo: Charles Cohen

McGRAW-HILL WORLD NEWS

Director: Ralph R. Schulz
Bonn: Robert Ingersoll
Brussels: James Smith
London: Marvin Petal
Madrid: Dom Curcio
Milan: Peter Hoffmann, Andrew Heath
Moscow: Peter Gall
Paris: Michael Johnson, Richard Shepherd
Stockholm: Robert Skole
Tokyo: Mike Mealey

PUBLISHER: Dan McMillan

DIRECTOR OF MARKETING: Pierre J. Braudé

ADVERTISING SALES SERVICE MANAGER:
Wallis Clarke

BUSINESS MANAGER: Stephen R. Weiss

CIRCULATION MANAGER: Nancy L. Merritt

MARKETING SERVICES MANAGER:
Tomlinson Howland

RESEARCH MANAGER: Margery D. Sholes

Automation, in this age of electronics proliferation, means the increasing application of some of the more sophisticated of electronics products to the world's production lines. And the production lines in electronics—especially in semiconductors—are no exception.

You'll find a good example of the trend toward automating electronics production in the lead-off article in our New Products section (p. 99). Written by our San Francisco bureau chief, Bernard Cole, the story highlights one of a new breed of automatic production machines—a semiconductor-wafer prober/sorter that can work through the weekend unattended. Without electronics, the machine could not have been built, since it has a microprocessor as its "brains" and a laser for "eyes."

Cole, incidentally, is no newcomer to the chronicling of technological trends. A graduate of San Diego State University, with a bachelor's degree in journalism and minors in physics and math, he later completed the special Advanced Science Writing Program at Columbia University's School of Journalism. After working for several West Coast newspapers, including the San Diego Union, he spent a couple of years as an associate editor and staff science writer for the California Institute of Technology's Engineering-Science Magazine before joining *Electronics*.

Mystery stories always make good reading. And when the mystery has to do with what's going to happen as environmental standards impact the glass fiber in printed-circuit boards, you know that some detective work is in order.

It seems that the electrical and mechanical properties of a new glass-fiber formulation, made to meet expected plant effluent and emission standards, are just different enough to make pc-board users reach for the aspirin bottle.

Tipped off to the problem by hearing dissatisfied mutterings about the new formulation from pc-board users, Andy Santoni, our instrumentation editor, started to track down the story, which you will find on page 62. As you might expect with users, manufacturers, and the Government involved, it's a complex situation, and, alas, the solution is not yet in sight.

We should explain here that Andy Santoni, recently named instrumentation editor, first ran across the problem when he was our packaging and production editor, the post he took on when he joined *Electronics* three months ago. Prior to that, he was associate editor-components for *Electronic News*.

Armed with a bachelor's degree in engineering from Cooper Union, Santoni started his engineering career at Westinghouse Electric Corp. and then spent three years at the Kearfott division of Singer, where he did design work for inertial navigation systems. At the same time, he managed to earn his master's degree in engineering, also from Cooper Union. His interests range from building his own electronic equipment to owning the complete works of mystery-story pioneer Wilkie Collins.

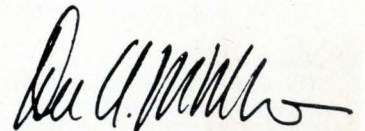

October 31, 1974 Volume 47, Number 22
95,166 copies of this issue printed

Published every other Thursday by McGraw-Hill, Inc. Founder: James H. McGraw 1860-1948. Publication office 1221 Avenue of the Americas, N.Y., N.Y. 10020; second class postage paid at New York, N.Y. and additional mailing offices.

Executive, editorial, circulation and advertising addresses: *Electronics*, McGraw-Hill Building, 1221 Avenue of the Americas, New York, N.Y. 10020. Telephone (212) 997-1221. Teletype TWX N.Y. 710-581-5234. Cable address: MCGRAW HILL L.N.Y.

Subscriptions limited to persons with active, professional, functional responsibility in electronics technology. Publisher reserves the right to reject non-qualified requests. No subscriptions accepted without complete identification of subscriber name, title, or job function, company or organization, including product manufactured or services performed. Subscription rates: qualified subscribers in the United States and possessions, Canada, and Mexico \$12.00 one year, \$24.00 three years; all other countries \$25.00 per year, except Japan and Israel \$50.00 per year, Brazil \$40.00 per year, Australia and New Zealand \$60.00 per year, including air freight. Limited quota of subscriptions available at higher-than-basic rate for persons outside of field served, as follows: U.S. and possessions and Canada, \$25.00 one year; all other countries \$50.00. Single copies: \$4.00.

Officers of the McGraw-Hill Publications Company: John R. Emery, President; J. Elton Tuohig, Executive Vice President-Administration; Gene W. Simpson, Group Publisher-Vice President; Senior Vice Presidents: Ralph Blackburn, Circulation; Walter A. Stanbury, Editorial; John D. Hoglund, Controller; David G. Jensen, Manufacturing; Gordon L. Jones, Marketing; Jerome D. Lutz, Planning & Development.

Officers of the Corporation: Shelton Fisher, Chairman of the Board and Chief Executive Officer; Harold W. McGraw, Jr., President and Chief Operating Officer; Wallace F. Traendly, Group President, McGraw-Hill Publications Company and McGraw-Hill Information Systems Company; Robert N. Landes, Senior Vice President and Secretary; Ralph J. Webb, Treasurer.

Title registered in U.S. Patent Office. Copyright © 1974 by McGraw-Hill, Inc. All rights reserved. The contents of this publication may not be reproduced in whole or in part without the consent of copyright owner.

Subscribers: The publisher, upon written request to our New York office from any subscriber, agrees to refund that part of the subscription price applying to copies not yet mailed. Please send change of address notices or complaints to Fulfillment Manager, subscription orders to Circulation Manager, *Electronics*, at address below. Change of address notices should provide old as well as new address, including postal zip code number. If possible, attach address label from recent issue. Allow one month for change to become effective.

Postmaster: Please send form 3579 to Fulfillment Manager, *Electronics*, P.O. Box 430, Hightstown, N.J. 08520.

KEPCO

your source for digitally programmed d-c power supplies



This, for example, is a typical digitally-controlled voltage stabilizer, comprising a standard Kepeco plug-in power supply with the new Kepeco SN Digital Interface.

The combination produces 0-100 volts, 0-200 mA with 12-bits resolution. The power supply is a Model PCX 100-0.2MAT programmed by an SN-12 Digital Interface Card mounted on a slide adapter and fitted to a dual-slot bench style enclosure.

There are hundreds of similar Kepeco Power Supplies, ranging from 0-6V @ 90 A to a model that can produce -5000V @ 5 mA. Because they're rated as *operationally programmable*, these models can be combined with one of the five Kepeco SN Digital Interfaces to produce a custom digital voltage or current source, tailored to your needs.

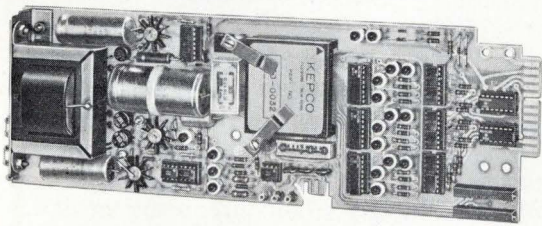

The SN Digital Interface Card accepts your data input on parallel lines, strobed for noise immunity, and stores the data in a buffer register. For isolation, the program is transferred across optical couplers so that your digital signal and the power supply it controls can be up to 1000V apart. The five SN Cards offer a choice of BCD or complementary binary programming.

The analog output from the SN Card is in the form of a 0-1V/0-10V range selected signal* that is linearly amplified by the companion power supply to produce the desired output. In the illustrated combination of SN-12 and a Kepeco Model PCX 100-0.2MAT, the power supply functions as a fixed gain-of-ten power amplifier to produce a digitally-controlled output, 0-100V with 12-bits (0.024%) resolution. The range selector on the SN allows the full resolution to be spread over the lowest 10% of the output: 0-10V d-c.

*The SN Card also produces $\pm 10V$ & $\pm 5V$ outputs to control bipolar power supplies and 0.5V, 1.0V outputs to control current stabilizers.

SN CARDS AVAILABLE

MODEL	RESOLUTION	LINEARITY
SN-2	2 BCD	$\pm 0.2\%$
SN-3	3 BCD	$\pm 0.05\%$
SN-8	8-bit	$\pm 0.2\%$
SN-10	10-bit	$\pm 0.05\%$
SN-12	12-bit	$\pm 0.01\%$

These SN Cards are fully self-contained digital programmers, featuring an on-card line operated power supply. Kepeco offers a variety of housings and accessories to accommodate them to various programmable power supplies. As many as eight cards can be accommodated in a standard 5 1/4" x 19" panel.

For complete specifications, write Dept. EH-14

KEPCO®



KEPCO, INC. • 131-38 SANFORD AVENUE • FLUSHING, N.Y. 11352 • (212) 461-7000
TWX #710-582-2631 • Cable: KEPCOPOWER NEWYORK

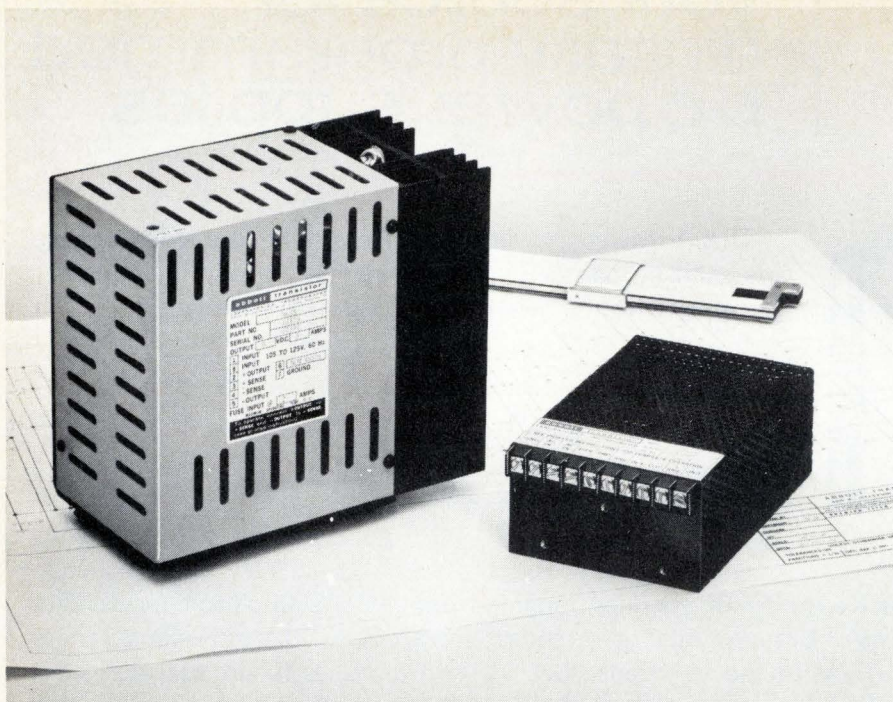

Reduce Your Power Supply Size and Weight By 70%

A new way has been found to substantially reduce power supply size and weight. Consider the large power supply shown at left in the above photo — it uses an input transformer, into a bridge rectifier, to convert 60 Hz to 5 volts DC at 5 amperes. This unit measures 6½" x 4" x 7½" and weighs 13 pounds. Abbott's new model Z5T10, shown at right, provides the same performance with 70% less weight and volume. It measures only 2¼" x 4" x 6" and weighs just 3 pounds.

This size reduction in the Model Z5T10 is primarily accomplished by eliminating the large input transformer and instead using high voltage, high efficiency, DC to DC conversion circuits. Abbott engineers have been able to control the output ripple to less than 0.02% RMS or 50 millivolts peak-to-peak

maximum. This design approach also allows the unit to operate from 100 to 132 Volts RMS and 47 to 440 Hertz. Close regulation of 0.15% and a typical temperature coefficient of 0.01% per degree Celsius are some of its many outstanding features. This new Model "Z" series is available in output voltages of 2.7 to 31 VDC in 12 days from receipt of order.

Abbott also manufactures 3,000 other models of power supplies with output voltages from 5 to 740 VDC and with output currents from 2 milliamps to 20 amps. They are all listed with prices in the new Abbott catalog with various inputs:

- 60 A to DC
- 400 A to DC
- 28 VDC to DC
- 28 VDC to 400 A
- 12-28 VDC to 60 A

Please see pages 307-317 Volume 1 of your 1974-75 EEM (ELECTRONIC ENGINEERS MASTER Catalog) or pages 853-860 Volume 3 of your 1974-75 GOLD BOOK for complete information on Abbott Modules.

Send for our new 60 page FREE catalog.

abbott transistor

LABORATORIES, INCORPORATED
general offices eastern office

5200 W. Jefferson Blvd./Los Angeles 90016
(213) 936-8185 Telex: 69-1398

1224 Anderson Ave./Fort Lee, N.J. 07024
(201) 224-6900 Telex: 13-5332

6 Circle 6 on reader service card

Readers comment

Actuator design 'better'

To the editor: C. P. Clare gives credit to Bell Systems' technology as the source for their design in the article "Self-latching relays offer 6 poles" [*Electronics*, Aug. 8, p. 131]. That may be true for C. P. Clare; however, the consequent pole principle—and that is the principle upon which their product is based—was first patented in 1960 by James Flora, president of my company.

Flora's design is by far the more flexible. The magnetic actuator is used in a number of products aside from latch relays. But, as a relay, any number of reeds may be assembled to a single device.

Fred Benoit
Advanced Magnetic Products Inc.
North Hollywood, Calif.

Clarifying OT's future

To the editor: A news item about the Office of Telecommunications [*Electronics*, Oct. 3, p. 63] is in several respects erroneous. It appears that certain recommendations by the Office of Management and Budget (OMB) are being misinterpreted by the press.

What OMB has recommended is that the technology portion of the OT program be consolidated in Commerce's National Bureau of Standards. OMB further recommended that the policy studies and frequency management services performed by OT for the Office of Telecommunications Policy be organized to report directly to the Assistant Secretary of Commerce for Science and Technology. Thus, all the present functions of OT would continue within the Department of Commerce. Only the reporting arrangements would be changed if the OMB recommendations were adopted. Moreover, it is not true that the OMB recommendations were based on alleged duplication of effort. Functions of the OT are essential to the efficient government use of the radio spectrum and the successful design of government communications systems.

John M. Richardson
Office of Telecommunications
Washington, D.C.

you can see why...

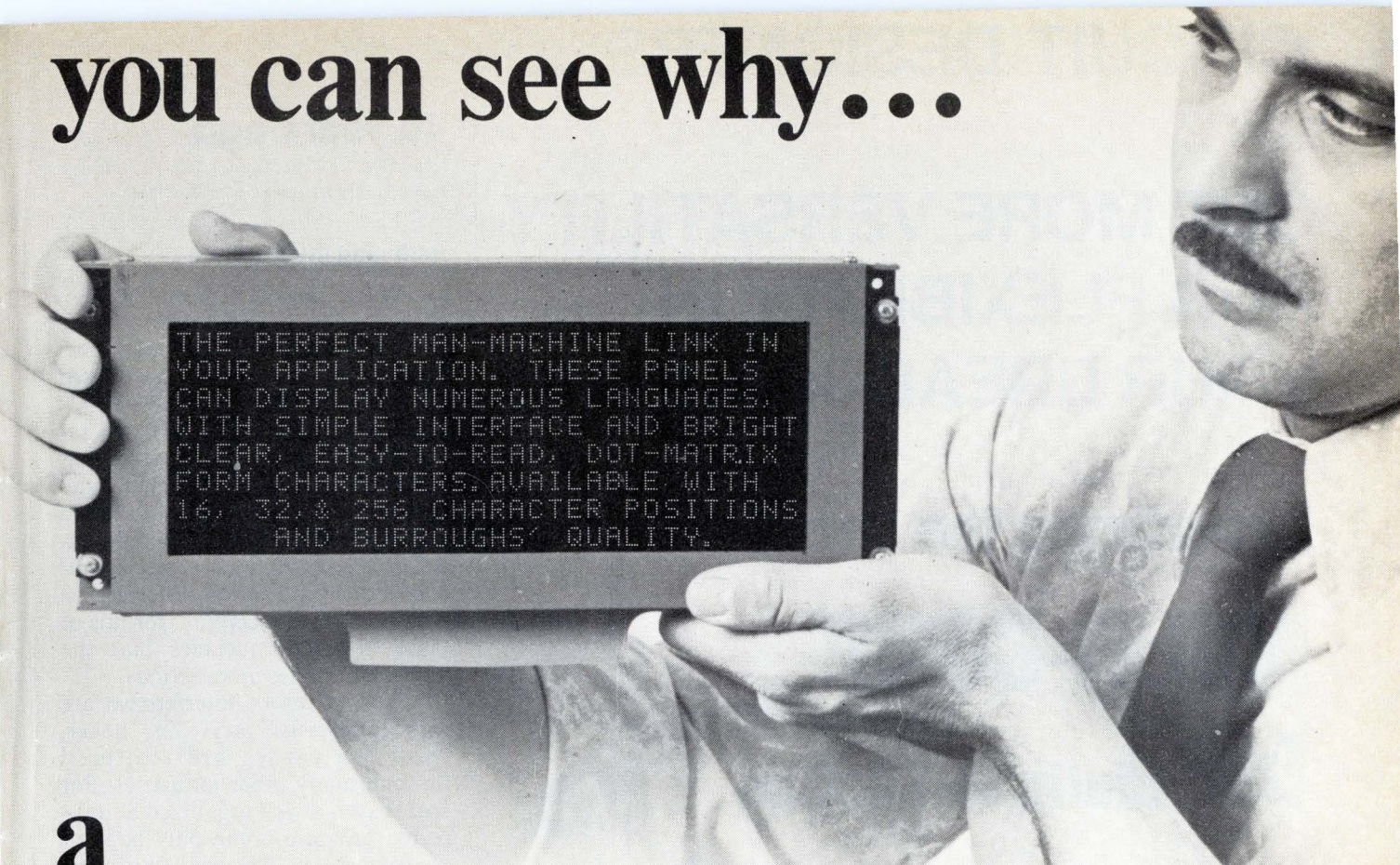

THE PERFECT MAN-MACHINE LINK IN YOUR APPLICATION. THESE PANELS CAN DISPLAY NUMEROUS LANGUAGES, WITH SIMPLE INTERFACE AND BRIGHT CLEAR, EASY-TO-READ, DOT-MATRIX FORM CHARACTERS. AVAILABLE WITH 16, 32, & 256 CHARACTER POSITIONS AND BURROUGHS' QUALITY.

a **SELF-SCAN**[®] PANEL is the best choice

SELF-SCAN panels are best because they can provide alphanumeric display of data — 16 to 256 characters per message — for data entry, automatic checkout systems, wherever man-machine interface takes place.

SELF-SCAN panels are best because they are brighter. Burroughs technology makes possible sharp characters with no fuzziness, no loss of focus, no distortion, a 120-degree viewing angle, and readability up to 25 feet with minimum glare and reading fatigue.

SELF-SCAN panels are best because they are the most versatile self-contained display panels commercially available. A wide variety of character generators offers 45 different displays, including Cyrillic, Hebrew and Katakana alphabets as well as standard ASCII code.

SELF-SCAN panels are best because they can be packaged in less than 1/2" depth and are less costly than CRT's with comparable message capability. The cost per light-emitting dot will amaze you.

Want to see SELF-SCAN panels in operation? Write the Electronic Components Division, P. O. Box 1226, Plainfield, New Jersey 07061, or call (201) 757-3400 or (714) 835-7335 for a demonstration.



You can see the difference

Burroughs

Circle 7 on reader service card



CIRCUIT DESIGNERS...

GET MORE VERSATILITY AND FLEXIBILITY IN YOUR BREADBOARDING.

Experience the convenience of

MULTI-COMP[®] DIP Multiple-Section Ceramic Capacitors

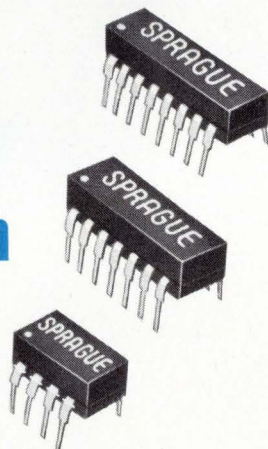

Breadboarding is a lot easier with Sprague Multi-Comp Monolithic[®] Ceramics. They readily plug in and out of standard DIP sockets for fast changes during experimentation. They come as 4-, 7-, and 8-section capacitors, in popular most-frequently-used capacitance values. By connecting capacitor sections in parallel, you can obtain

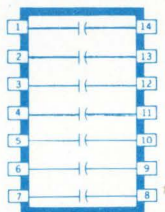

practically any value your circuit needs. With a few Multi-Comp capacitors on hand, there's no need to keep heavy stocks of individual capacitors for breadboarding purposes. There's less soldering and unsoldering, too.

And when your final capacitance determinations are made, you can either stay with DIP Multi-Comps, or switch to Sprague Single-Section Monolithic[®] Capacitors, which have the same layer-built construction and the same electrical characteristics.

**GET THE DIP HABIT —
TRY MULTI-COMP[®] MONOLITHIC[®] CAPACITORS IN YOUR NEXT
BREADBOARD DESIGN — THEY'RE READILY AVAILABLE FROM
YOUR SPRAGUE INDUSTRIAL DISTRIBUTOR!**

For more information, write or call
Ed Geissler, Mgr., Specialty Components
Marketing, Sprague Electric Company,
35 Marshall Street, North Adams, Mass. 01247.
Tel. 413/664-4411.



THE BROAD-LINE PRODUCER OF ELECTRONIC PARTS

8 Circle 8 on reader service card

40 years ago

From the pages of Electronics, October, 1934

Reducing interference

Dr. W.R.G. Baker of Camden, N.J., chairman of the Engineering Division of the Radio Manufacturers Association, is to be congratulated on the leadership which he and his associates are putting behind the aggressive program to reduce radio interference. Working with that indefatigable wheelhorse of radio improvement, Virgil Graham, Dr. Baker is properly laying special emphasis on eradicating interference with shortwave reception, for it is in these higher frequencies that the damage becomes more serious.

"The sources of interference are very numerous," says Dr. Baker, "and the causes are scattered through many other industries. For that reason a well organized and directed program is the only hope of securing results. The use of the short waves for broadcasting has tremendously broadened the scope of interference elimination work, and any public use of ultrashort waves will still further do so. As a specific instance, motor-car interference is not a factor in the standard broadcast range, but in many locations it is the limiting factor on short-wave reception."

German radio receivers

More than 75% of all sets sold in Germany in the last season have been of the two-tube type. There is a special reason for this. All the German manufacturers, by order of the government, are forced to make an exact copy of a two-tube set following an official design. This is the so-called "Folks-empfänger." Not only has the circuit of this set been exactly prescribed but the cabinet design and the retail price as well. It consists of one tuning circuit with a regenerative detector and a pentode output tube. The official price is 76 marks (about \$30). The main purpose of the German government in creating this "cheap" receiver has been to give all German families a chance to listen to the government propaganda broadcasts.

Dialight sees a need:

(Need: The widest choice for your every application.)

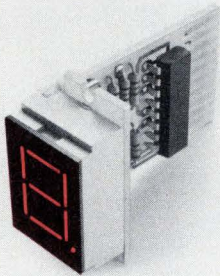

730 SERIES Your choice . . . a red or green LED readout with large 0.625" characters . . . low power, operates with standard IC power supply levels. Comes in plus-minus module. Display uses standard or high brightness LEDs for maximum light output arranged in a seven-segment format. Available with or without on-board decoder/driver. Unique lens design generates bright, highly legible characters.



739 SERIES Save design time and installation costs . . . this LED display assembly is attractively designed in a convenient package with bezel and is ready for instant panel mounting. Available in groups of one or more characters, with or without decoder/driver . . . characters are 0.625" and come with either green or red LEDs in seven-segment format. Readout offers lowest cost per character for comparable size.

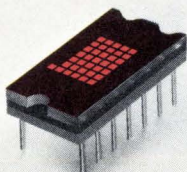

745-0005 Dot matrix LED readout display produces a bright 0.300" high character or symbol display. Has wide angle visibility and is compatible with USASCII and EBCDIC codes. Low power requirements. Mounts into standard 14-pin DIP socket. The display is also available in bezel assemblies with or without code generator.

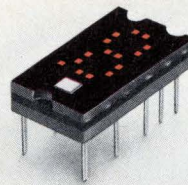

745-0007 LED hexidecimal display with on-board logic operates from 5 to 6 volt supply, low power consumption. Integral TTL MSI chip provides latch, decoder and drive functions. 0.270" character display has wide angle visibility and mounts into standard 14-pin DIP socket.



755 SERIES High brightness planar gas discharge displays in a 0.550" character. Orange color gives high contrast ratio and allows readability to 40 feet even in high ambient lighting. Designed for interfacing with MOS/LSI, displays have an expected life of 100,000 hours or more.

Dialight, the company with the widest choice in switches, LEDs, indicator lights and readouts, looks for needs . . . your needs . . . and then they develop solutions for your every application. No other company offers you one-stop shopping in all these product areas. And no other company has more experience in the visual display field. Dialight helps you do more with these products than any other company in the business, because we are specialists that have done more with them. Talk to the specialists at Dialight first. You won't have to talk to anyone else.

DIALIGHT

Dialight, A North American Philips Company
203 Harrison Place, Brooklyn, N. Y. 11237
(212) 497-7600

See Dialight.

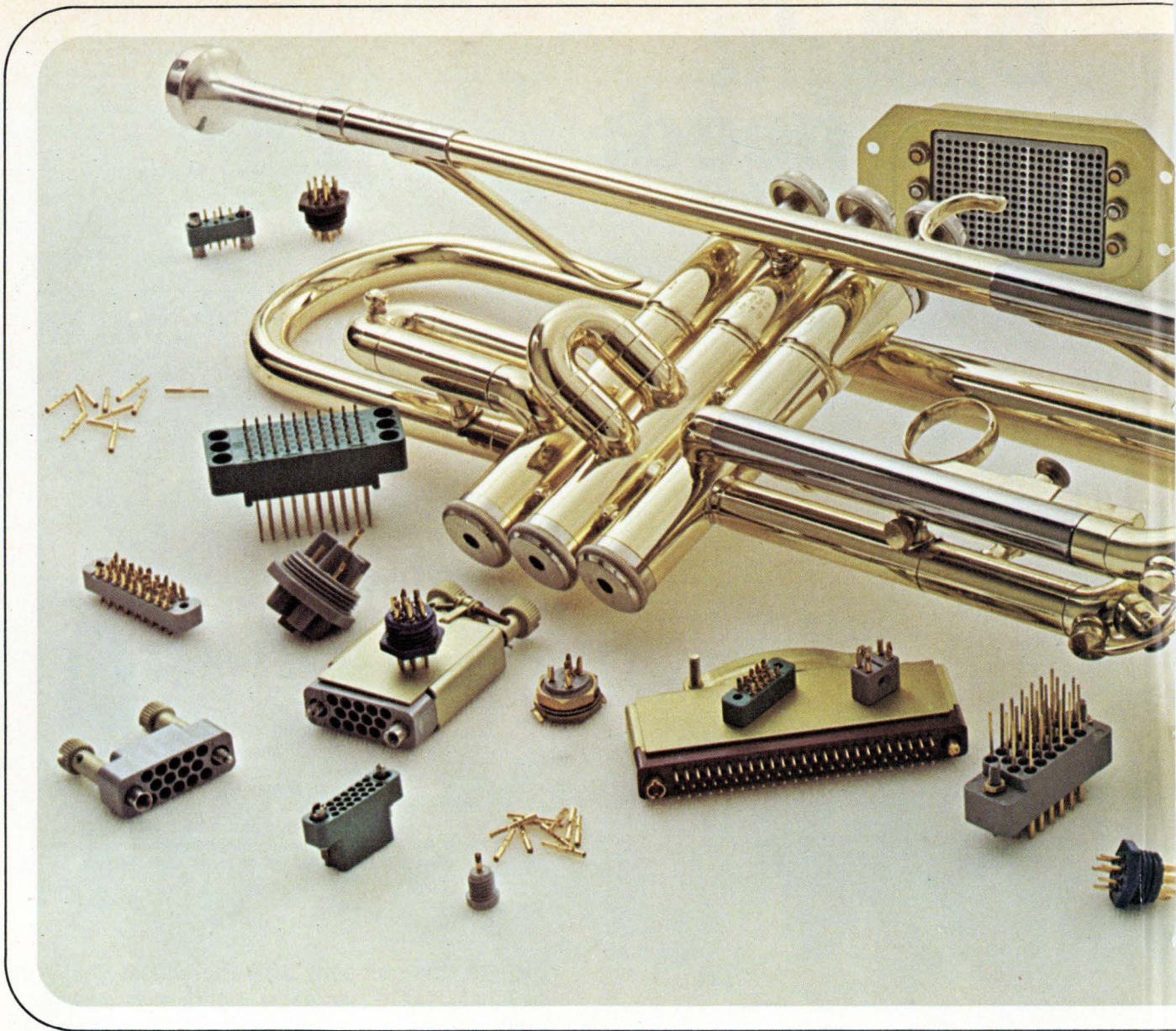

Get on the horn!

Winchester Electronics Rack & Panel Connectors

Authorized Winchester Electronics Distributors

Avnet Electronics
Culver City, California 90230
Telephone: 213-559-4111
Telex: 67-3692
TWX: 910-340-6364
Cramer Electronics, Inc.
Newton, Massachusetts 02159
Telephone: 617-969-7700
TWX: 710-335-1071
Elmar Electronics
Mt. View, California 94042
Telephone: 415-961-3611
TWX: 910-379-6437

Elmar Electronics
Commerce City, Colorado 80022
Telephone: 303-287-9611
TWX: 910-936-0770
Greene-Shaw Company, Inc.
Newton, Massachusetts 02195
Telephone: 617-969-8900
Telex: 92-2498
Hamilton-Avnet Electronics
Phoenix, Arizona 85034
Telephone: 602-275-7851
TWX: 910-951-1535

Hamilton-Avnet Electronics
Schiller Park, Illinois 60176
Telephone: 312-678-6310
TWX: 910-227-0060
Hamilton-Avnet Electronics
Edina, Minnesota 55435
Telephone: 612-941-3801
Hamilton-Avnet Electronics
Westbury, L.I., New York 11590
Telephone: 516-333-5800
TWX: 510-222-8237

Hamilton-Avnet Electronics
Bellevue, Washington 98005
Telephone: 206-746-8750
TWX: 910-443-2449
Hamilton-Avnet International (Canada) Ltd.
St. Laurent
Montreal, Quebec H4S1G2, Canada
Telephone: 514-331-6443
TWX: 610-421-3731
Hamilton-Avnet International (Canada) Ltd.
Mississauga, Toronto, Ontario, Canada
Telephone: 416-677-7432
TWX: 610-492-8867

Harrison Electronics Corporation
Farmingdale, L.I., New York 11735
Telephone: 516-293-7990
TWX: 510-224-6403
Lectronix, Inc.
St. Charles, Missouri 63301
Telephone: 314-946-6424
TWX: 910-760-1720
Liberty Electronics
Phoenix, Arizona 85017
Telephone: 602-257-1272
TWX: 910-951-1530

Liberty Electronics
El Segundo, California 90245
Telephone: 213-322-8100
TWX: 910-348-7111
Liberty Electronics
San Diego, California 92121
Telephone: 714-565-9171
TWX: 910-335-1590
Liberty Electronics N/W
Seattle, Washington 98108
Telephone: 206-763-8200
TWX: 910-444-1379

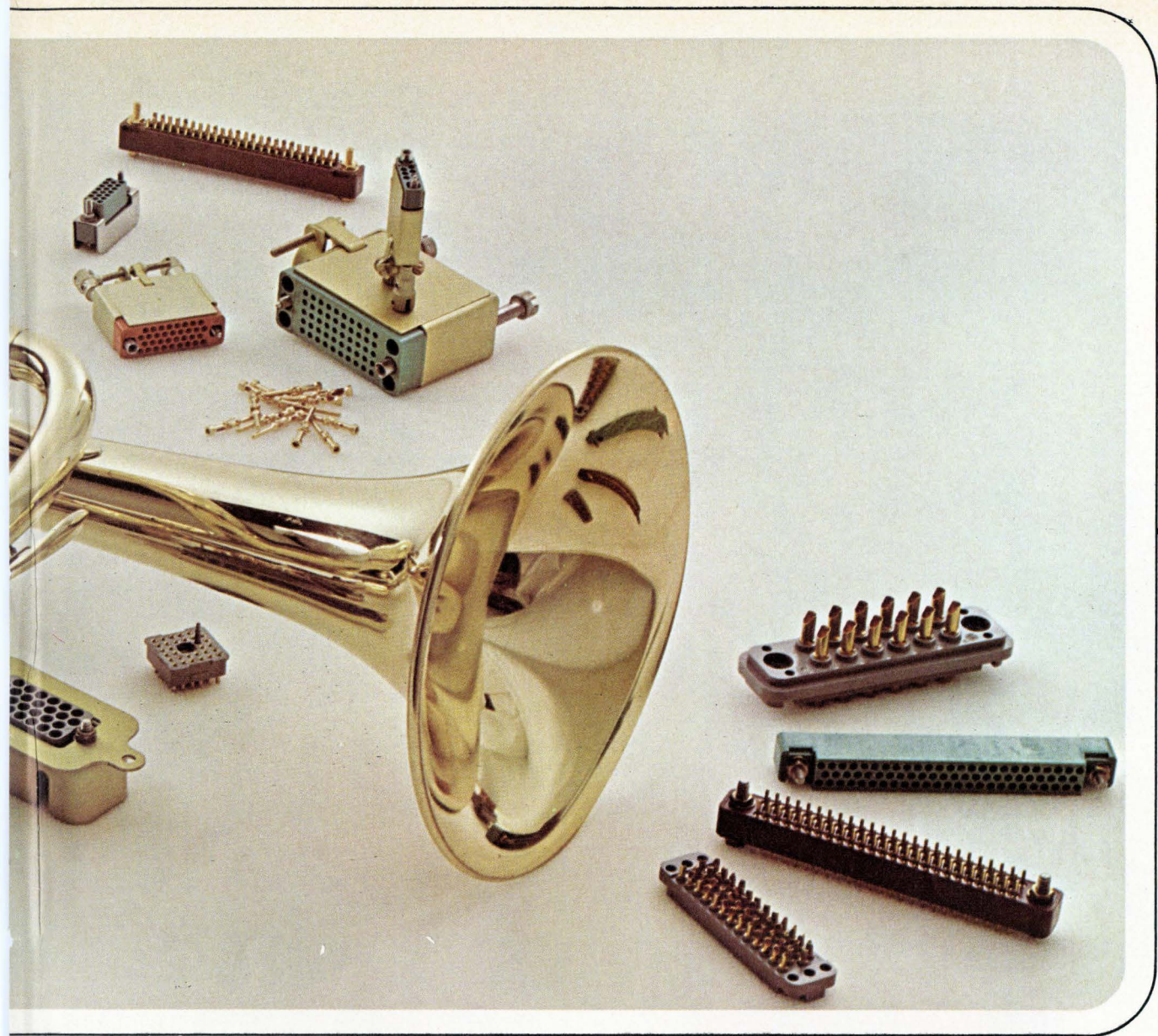

When your new electronic packaging design idea is making sweet music, you don't need sour notes.

But it happens. Your idea stops in mid-beat. The critical, "standard" rack and panel connector you've specified isn't available. Your symphony goes unfinished. And you've got to start over.

But don't. Instead, get on the horn to your local Authorized Winchester Electronics Distributor. Your design will begin to make good sounds, again. Because he'll have exactly the rack and panel connector you want — off-the-shelf. He will because Winchester Electronics backs up the responsive, professional Authorized Distributors serving you. So you order from a truly broad, comprehensive array of rack and panel connectors . . . with literally thousands of configuration possibilities to fit your idea. It's design-by-specifying . . . our consistent refrain of design-flexible, "custom" rack and panel connectors available immediately and at non-custom prices.

You can specify from our MRAC Series. With 12 configurations covering 9 to 104 crimp removable contact patterns. With polarizing hoods. Guides. And vibration locks equal to 750G shock impacts. Or use subminiatures like our SREC Series for close quarters and light weight. Or our RW Series for high density, automatic wiring techniques. Or our NIM Series types for nuclear instrumentation modules. All these and more.

So keep us in mind. When you've got a connector problem that could stop the music, your Authorized Winchester Electronics Distributor has the solution. He'll solve your problem quickly and harmoniously . . . to let your design play. Winchester Electronics, Main Street & Hillside Avenue, Oakville, Connecticut 06779 (203) 274-8891.



WINCHESTER ELECTRONICS

Litton

Moltronics
Southgate, California 90280
Telephone: 213-773-6521
TWX: 910-580-1947
Pan Electron, Inc.
Higashikata-Machi, Midori-ku
Yokohama 226, Japan
Telephone: 045-471-8321
Telex: 382-2865
Powell Electronics/Huntsville
Huntsville, Alabama 35807
Telephone: 205-539-2731
TWX: 810-726-2231

Powell Electronics/California
Mt. View, California 94040
Telephone: 415-964-0820
TWX: 910-379-6970
Powell Electronics/Florida
Miami Springs, Florida 33166
Telephone: 305-592-3260
Powell Electronics
Orlando, Florida 32809
Telephone: 305-859-1450
TWX: 810-850-0155

Powell Electronics/Washington
Beltzville, Maryland 20705
Telephone: 301-937-4030
TWX: 710-828-9710
Powell Electronics/Philadelphia
Philadelphia, Pennsylvania 19101
Telephone: 215-365-1900
TWX: 710-870-0485
Radio Distributing Company, Inc.
Chicago, Illinois 60635
Telephone: 312-237-1105

Radio Distributing Company, Inc.
South Bend, Indiana 46624
Telephone: 219-287-2911
TWX: 810-299-2583
Radio Distributing Company, Inc.
Cleveland, Ohio 44143
Telephone: 216-461-9090
Stack Industrial Electronics, Inc.
Binghamton, New York 13902
Telephone: 607-723-6326
TWX: 510-252-1997

Sterling Electronics
Dallas, Texas 75229
Telephone: 214-357-9131
Telex: 73-2352
Sterling Electronics
Houston, Texas 77027
Telephone: 713-623-6600
Telex: 77-5299
Summit Distributors, Inc.
Buffalo, New York 14202
Telephone: 716-884-3450
TWX: 710-522-1692

Wiltshire Electronics/New England
Burlington, Mass. 01803
Telephone: 617-272-8200
Namco Electronics
Victoria 3818, Australia
Telephone: 96-2891
Telex: AA31261
Radiokom (Pty) Ltd.
Randburg, South Africa
Telephone: 48-5712
Telex: 43-0838 SA



The KIT-8/A component computer gives you minicomputer power at a microprocessor price.

\$572 in quantities of a hundred. (CPU & 1K RAM.)

We've put the world's most experienced minicomputer, the PDP-8, on a single board and called it the KIT-8/A.

And we've done it using proven, readily-available, multi-source MSI semiconductor technology.

The KIT-8/A will give you speed and performance at a very low price. It's a full-scale 12-bit computer, the latest in the PDP-8 family. With 1.5

μ sec cycle time, a huge, healthy software library, and the same powerful instruction set as the PDP-8/E. And it's fully compatible with most PDP-8 family hardware, operating systems, and high-level programming languages like BASIC, FORTRAN IV, and FOCAL.

The Omnibus™ backplane makes it easy to interface the KIT-8/A directly to more than 60 PDP-8 options and peripherals.

To make your life even easier, we've made the seven most-requested options available on two option boards. On one board, we've put the serial-line interface, 12-bit parallel I/O, front-panel control and real-time clock. On the other, we've put the bootstrap loader, power-fail/auto-restart, and memory extension.

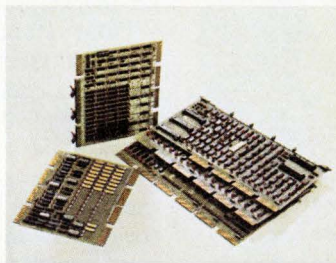

The KIT-8/A and option boards.

We've employed expandable semiconductor memory to enable you to tailor your memory capacity to your needs, from 1K to 32K words. Choose ROM, RAM, PROM, or ROM/RAM combinations — mix and match to suit your application.

The KIT-8/A will enable the sophisticated user to give his system true computer capability at a very low price: \$572 in quantities of a hundred (for CPU and 1K RAM).

We start delivering in late 1974. We're accepting volume orders right now. To place yours, call 800-225-9480. Toll-free from 8:30 AM to 5:30 PM Eastern time. (US only. Massachusetts residents, please dial (617) 481-7400, extension 6653.)

We're the Components Group of Digital Equipment Corporation, One Iron Way, Marlborough, Massachusetts 01752.

In Canada: Digital Equipment of Canada Limited, P.O. Box 11500, Ottawa, Ontario, K2H8K8. (613) 592-5111, extension 154.

digital
COMPONENTS
GROUP

Unbundling the world's most popular minicomputer systems.

FREE Engineering Handbook from RCL Electromagnetic Delay Lines

Including Dual-In-Line
(DIP)

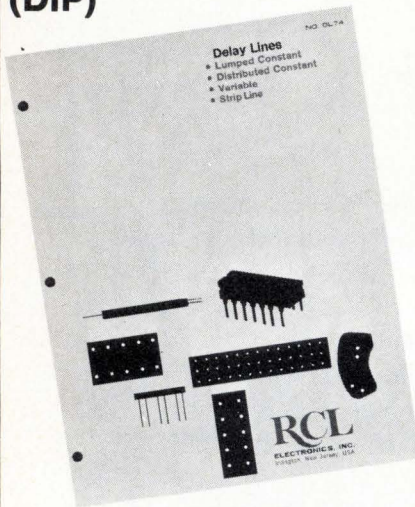

NEW '75 EDITION

Terms... engineering definitions... test methods... how to specify delay lines... characteristics of various types... specifications... they're all included in this concise, easy-to-read handbook... yours for the asking.

DIP DELAY LINES
LUMPED CONSTANT...
DISTRIBUTED CONSTANT
...VARIABLE

NEW LOW PRICED SERIES
OF COMMERCIAL
DIP DELAY LINES

RCL

RCL ELECTRONICS, Inc.,

General Sales Office:

Seven Hundred
South Twenty First Street
Irvington, New Jersey 07111

People

Lamond sees laser
promise almost here

As the new president of Coherent Radiation, Pierre Lamond has a very straightforward ambition: to boost the company to become the National Semiconductor Corp. of the laser industry.

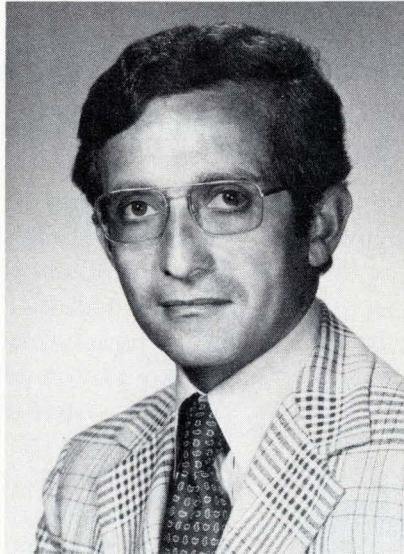

Zooming. The great potential for growth made Lamond switch to lasers.

His ambition is understandable. Until a few months ago, he was vice president and general manager of semiconductor manufacturing at National. In fact, he was one of the key people whom National's president, Charles Sporck, brought with him when he left Fairchild Semiconductor in 1967, and also one of those instrumental in transforming National from a money-losing producer of discrete components into a broad-based, \$213 million-a-year manufacturer of integrated circuits.

Not that Coherent Radiation, based in Palo Alto, Calif., is in the shape National was in the mid-1960s. Far from it. With commercial laser sales this year of \$16 million, Lamond says the company is second only to Spectra-Physics Inc. of nearby Mountain View.

Embryo. "But the laser marketplace, in terms of its potential, is still in the embryonic stages," he says. "That, to me, is the challenge. Until

recently, the primary customer has been the military, or military-related industries. In 1973 military sales were about \$180 million compared to \$90 million in commercial sales. In 1974 total commercial sales of lasers is expected to top \$110 million. And by 1980 this market should triple."

In this environment the 43-year-old Lamond modestly expects Coherent Radiation to grow by at least 25% a year and to improve its share of the market significantly.

Lamond's demeanor is a paradoxical combination of boyish enthusiasm and scholarly precision. He exhibits a knowledge of his company and its technology that is amazingly broad in view of the short time he has been there. It lends credibility to his contention that Coherent will dominate the laser marketplace in future years.

"Our strength in the past has been in lasers for industrial, construction, medical and scientific applications," he says. "But the real market is in point-of-sale and graphic systems; in computer memory and in the field of imaging for video and facsimile reproduction, as well as in holography."

OTP's Eger struggles
to cope with change

John Eger's favorite piece of graffiti is a line, "There are too many simple answers and not enough simple problems." For Eger, the

Policy maker. Eger of OTP hopes his organization will get much more visibility.





You already have everything you need to keep our keyboards clean.

Getting any keyboard dirty is easy.

From that point on, things become more difficult. Because the contacts on mechanical keyboards are very sensitive to contamination. And, if the dirt hasn't already gotten to them, the cleaning process might.

MICRO SWITCH makes the cleaning process easy. All it takes is a bucket of hot, sudsy water. And maybe a brush.

Because MICRO SWITCH has solid-state keyboards. Designed around Hall effect chips that are completely encapsulated, they're impervious to just about any contaminant you can name.

So things like dirt and coffee can't get in. And neither can a bath in hot, sudsy water.

It makes your equipment maintenance a lot easier. And, in the long run, can substantially reduce service costs. Besides giving you a keyboard with all the built-in reliability of a solid-state design in the process.

If you'd like more information on MICRO SWITCH keyboards, call, toll-free, 800/645-9200 (in N.Y., call 516/294-0990, collect) for the location and telephone number of your nearest MICRO SWITCH Branch Office.

You'll see a line of keyboards that work like a dream. And wash like a coffee cup.

Circle 15 on reader service card

MICRO SWITCH

FREEPORT, ILLINOIS 61032

A DIVISION OF HONEYWELL

MICRO SWITCH products are available worldwide through Honeywell International.

Pulse withstand capacitors for colour T.V.

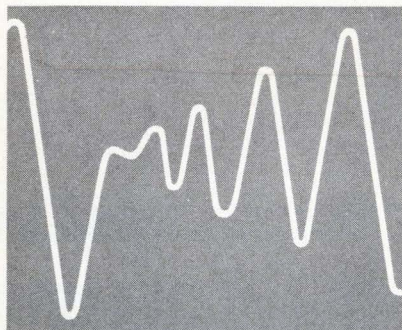
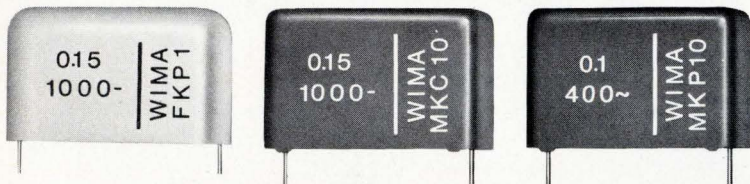

WIMA FKP 1

Polypropylene film and extended foil electrode capacitors encapsulated in cast resin. Self-healing properties. Suitable for sharp-edged or short rise time pulses in thyristor deflection circuits.

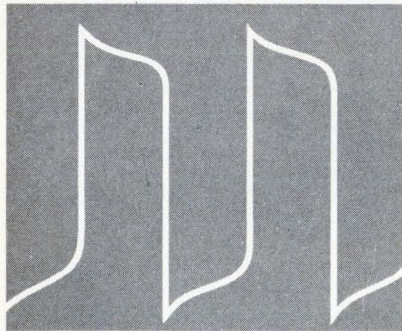

WIMA MKC 10

Metallized polycarbonate capacitors. Particularly suitable for stringent pulse and surge conditions. Low power factor at high frequencies. Self-healing properties. Plastic case design.

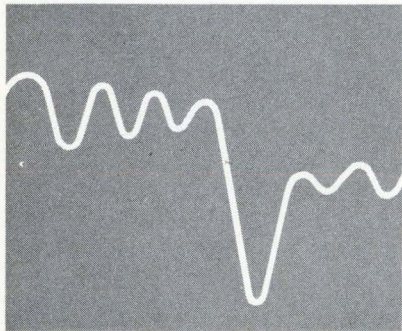

WIMA MKP 10

Metallized polypropylene capacitors in plastic cases. Self-healing properties. Suitable for both high current and pulse circuits owing to low dielectric losses.

- Other special capacitors in metal cases.
- One year successful field experience in equipment by leading manufacturers.
- Suitable for advanced solid-state equipment.
- For professional electronics.



WILHELM WESTERMANN

Spezialfabrik für Kondensatoren
D-68 Mannheim 1
Fed. Rep. of Germany
Augusta-Anlage 56
P. O. Box 2345
Tel.: (621) 40 80 12

People

cliché is particularly appropriate because the White House Office of Telecommunications Policy, which he now directs, has long suffered under the criticism that its approach to the complexities of modern telecommunications has been overly simplistic. It is an image that OTP's 34-year-old acting chief, a former Chicago trial lawyer who joined OTP as its second-in-command a year ago, is anxious to change.

"Too often we have been *ad hoc*ing it," the always affable Eger conceded recently. But the 52 people who make up the small policy-making group have often been unable to do much else, thanks to the explosion of telecommunications issues that has hit Washington during the four years in which OTP has been evolving.

Changes? OTP's manpower burden has been somewhat eased by its acquisition this past year of the support of approximately 100 persons in the Commerce Department's Office of Telecommunications. But Eger hopes to make it even more effective. He is convinced that the Executive branch department requires greater public visibility if it is to grapple effectively with the multitude of policy matters.

To interconnection buffs who see their industry not far advanced in the six years since the FCC's landmark Carterfone decision, Eger observes that "the troublesome thing about policymaking is that there's a vast difference between articulating a policy and implementing it." Implementation, he says, "is where the real blood, sweat and tears have to be shed." Basic policy decisions not only do not sweep away old problems, they "create a whole range of new ones."

If Eger survives the political shakeout yet to come in the Ford Administration—and current betting is that he will—he can be expected to push OTP deeper into communications policy issues. When that happens, the trim OTP leader will likely find even less time for such interests as tennis and golf—which he concedes he pursues on an *ad hoc* basis.

Write for our new catalogue.

Meetings

1974 Semiconductor Test Symposium—Memory and LSI, IEEE, Rickshaw Inn, Cherry Hill, N.J., Nov. 5-7.

Electro-Optical Systems Design Conference and Exhibition, Civic Auditorium/Brooks Hall, San Francisco, Nov. 5-7.

Communications and Power Conference, IEEE, Queen Elizabeth Hotel, Montreal, Que., Nov. 6-8.

Ultrasonics Symposium, IEEE, Pfister Hotel, Milwaukee, Wis., Nov. 11-13.

Electrical/Electronics Insulation Conference, NEMA, IEEE, and IPC, John B. Hynes Veterans Auditorium and Sheraton-Boston Hotel, Boston, Nov. 11-14.

International Semiconductor Laser Conference, IEEE, Atlanta Inn, Atlanta, Ga., Nov. 18-20.

Communications Transmission Seminar on Wideband Analog Cable Systems, IEEE and Princeton University, Engineering Quadrangle, Princeton, N.J., Nov. 19.

Specialist Conference on Technology of Electroluminescent Diodes, IEEE, Atlanta Inn, Atlanta, Ga., Nov. 20-21.

Electronica '74—International Fair on Components and Production Equipment, Munich Fair Co., Fairgrounds, Munich, Germany, Nov. 21-27.

Sixth International Congress on Microelectronics, IEEE et al., Congress Hall and Fairgrounds, Munich, Germany, Nov. 25-27.

First National Microprocessor Conference, Arthur D. Little Inc., Sheraton-Boston Hotel, Boston, Dec. 2-3.

National Telecommunications Conference, IEEE, Sheraton Inn, Harbor Island, San Diego, Calif., Dec. 2-4.

Electronics/October 31, 1974

Q3

**Quick,
Quiet,
Quality ...**

... in the smallest thermal non-impact incremental printer available. Offering twice the speed — at half the cost — of anything else on the market, the new Q3 comes in 60- and 30-character-per-second versions, or NCR-compatible models. There's little mechanical to cause problems. Full electronic design insures maximum reliability and interface flexibility.

Check out the Q3, and see how our numbers add up to the right answer for your printer needs.

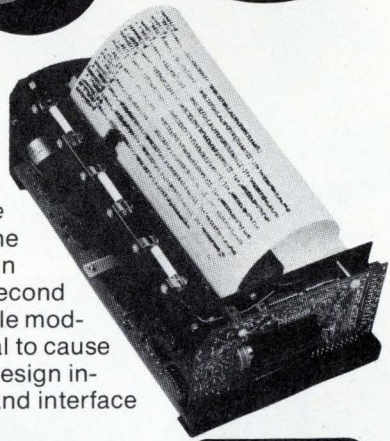

**COMPUTER
DEVICES INC.**

OEM Products Group
11 Ray Avenue, Burlington, Mass. 01803
617-273-1550

a
TECHVEN
corporate partner

Circle 17 on reader service card

At Last.

A Data Acquisition System In a Single Module.

Save time and money ... translating analog data into digital words. Data Translation's **DATATM** is a line of fully integrated data acquisition system modules that outperforms clusters of modules ... and all at lower cost.

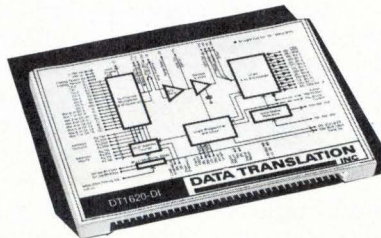

Imagine, for \$395 in 100's you get a complete system that includes:

- 16 Channel Multiplexer
- High Performance Differential Amplifier
- High Speed Sample/Hold Amplifier
- 12-Bit A/D Converter
- All Control and Programming Logic

**DATA TRANSLATION
INC**

109 CONCORD STREET, FRAMINGHAM, MA 01701

Call us at 617/879-3595 for a complete set of applications data. Or call your local representative below.

205-539-4411	303-934-5505	904-243-6424	504-366-5766	215-925-8711	919-489-1546	713-688-9971
602-947-7841	305-425-5505	305-723-0766	301-953-3724	505-299-7658	216-585-8421	214-231-2573
213-938-2833	305-776-4800	404-939-1674	314-997-1515	201-569-2230	615-584-2614	703-527-3262
415-941-4410		913-649-4000		716-334-2445		206-454-0900

Circle 116 on reader service card 17

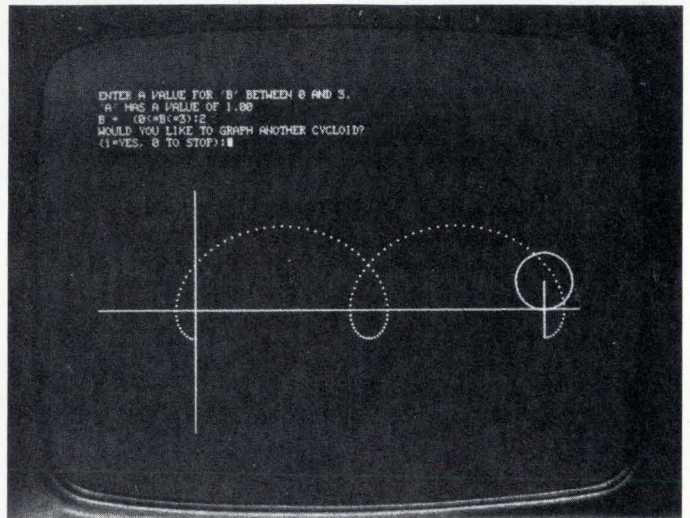
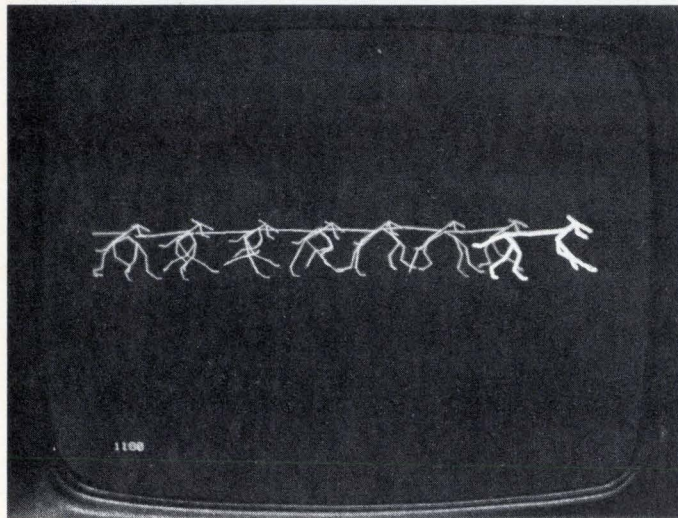
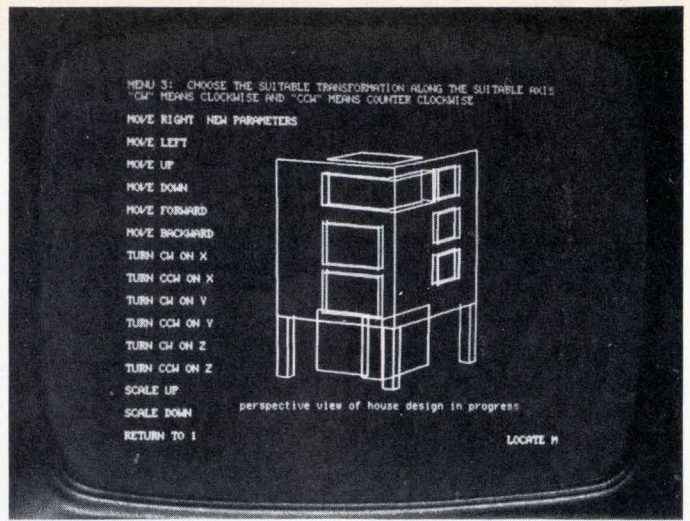
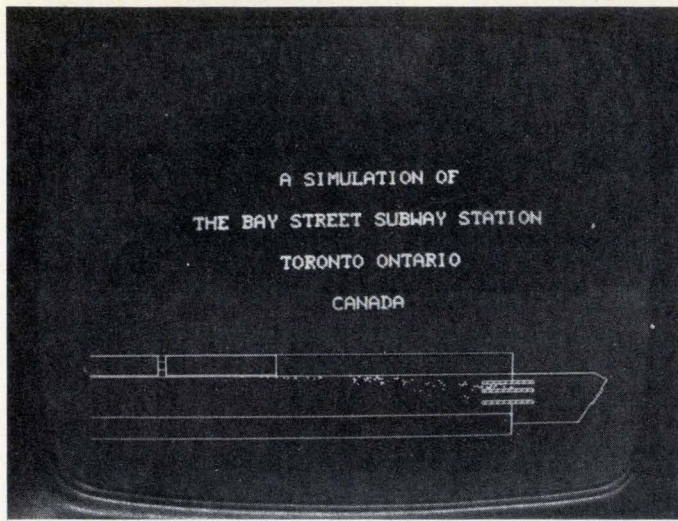

Digital announces a whole new way to look at graphics.

Right now is the time to look at graphics in a way you've never looked before.

Because graphics has come of age. And Digital feels you're about to see a tremendous increase in the use of graphic systems. In science, research, medicine, business and industry.

We've been making graphic systems almost as long as we've been making computers. And today, we may have the broadest range of computerized graphic systems available.

In our GT Series alone, we offer three multi-purpose graphic systems.

The GT40 includes a PDP 11/10 processor, 8K words of memory, keyboard, and 12" screen with light pen.

Extensive peripheral and application software is also available.

For expanded needs, the GT42 offers a 17" screen with light pen and communications interface.

And the powerful GT44 system provides a high performance PDP 11/40 processor with 16K words of memory, 17" screen with light pen, and our own DECwriter for hard copy.

Besides graphics, you can use these systems for virtually any computer application. And they're backed by an extensive array of peripherals and software. Plus Digital's worldwide service organization.

And should you already be a PDP-11 user, a graphic add-on may give you a totally new perspective on meeting your needs.

So if you're looking into graphics, be sure to see us. Write Graphics Group, Digital Equipment Corporation, Marlboro, Mass. 01752. Or call (617) 481-9511, Ext. 6936. European headquarters: 81 route de l'Aire, 1211 Geneva 26. Tel: 42 79 50.



digital

Intel to offer powerful, flexible micro system

An updated version of the semiconductor industry's first microprocessor, the 4004, will be introduced in November by Intel Corp. Called the 4040, **the 24-pin device will serve as central processor of a new family of MOS 4-bit microcomputer circuits called the MCS 40.** The 4040-based system will add high power and flexibility to Intel's low-cost 4-bit systems. For example, the price will be \$20 to \$30 for small system automation preprocessing and diagnostics; \$30 to \$40 for stand-alone use as data processors and controllers and relatively complex products, and large scale "distributed intelligence" applications; \$40 to \$50 for applications requiring larger memory capacities or other expansions; and around \$100 for single units or small-volume systems for such applications as prototype equipment development.

The MCS 40 features automatic interrupt processing, a large set of 60 instructions, single-step operation, CPU standby at low power, and a clock rate of 1 megahertz—about one-third more than the 4004-based MCS 4 system. As for flexibility, two other capabilities of the MCS 40 are bank switching of registers and instruction, memory and input/output arrays.

Signetics lists 35-ns PROM

To keep pace with the growing demand for more easily programed microprocessor memory elements, Signetics Corp. has built a 4,096-bit bipolar programable ROM. Using its standard Schottky TTL process and conventional nichrome fusible-link construction, Signetics has turned out a part with an access time of only 35 nanoseconds. **This means a user need not speed-scale its prototype microprocessor system**—the new PROM is as fast as the masked ROMs that go into the final system. In fact, it is pin compatible with Signetics' 8205 mask-programable ROM. The device is organized as 512 words by 4 bits, and comes in a 24-pin dual-in-line package. Signetics says it's in volume production, shipping 1,500 to 2,000 per month.

Intel Corp. and Monolithic Memories Inc. had earlier announced their own 4k PROMs. Intel's, like Signetics' a Schottky TTL device, is organized as 512 words by 8 bits and has a maximum access time of 70 ns. Its standby power dissipation is only .06 milliwatt per bit. Housed in a standard 24-pin DIP, it is pin compatible with Intel's 3304 metal-mask ROM. Intel, which has already begun to ship parts, is geared for high-volume last-quarter production.

Traffic-control market past peak as funds tighten

The funding high point for computerized highway traffic-control systems has been passed as the energy crisis, inflation, and changes in Federal programing **have curtailed planning by state and local agencies,** according to an internal study carried out by the Federal Highway Administration.

FHA's data shows that 26 communities are proposing new projects, compared to the 62 communities that turned in requests last year. Almost 10,000 electronic traffic sensors and dozens of minicomputers would have been procured if all the plans had been approved, but the agency now has only \$600 million for its entire traffic program, including such popular non-electronics projects as setting up express bus

lanes, fringe parking lots, and others. The average computerized traffic-control project can cost up to \$500,000, industry reports, **so the potential loss of business is in the millions.**

Low-power RAM to be marketed by Intel

Intel Corp. will begin to offer commercially by the end of this year its 80-nanosecond 1,024-bit n-channel dynamic RAM. The device, designated 2105, **has been used up to now only in-house.** It is expected to compete strongly with the 7001 n-channel RAM and find its way into many bipolar applications. With a cycle time of 180 nanoseconds and a standby power of only 100 microwatts per bit, the 2105 is aimed at cache and buffer memories that require speed and low power dissipation. Comparable 1k bipolar memories, although fast enough, dissipate three or four times the power of the 2105.

China interested in supplying Hong Kong market

The People's Republic of China has expressed preliminary interest in **supplying electronic components, parts, and raw materials to Hong Kong**—a market that could generate \$100 million in business annually from American manufacturers operating there, according to William F. Baker Jr. Baker is president of Electronic Industry Ltd., a General Electric Co. affiliate in Hong Kong, and an official of the American Chamber of Commerce there.

Baker made his forecast after returning from the PRC Export Commodities Fair in Canton, where, he said, Chinese officials expressed interest in the concept. Baker said **the quality of Chinese components seen in Canton make them suitable for use.**

Interconnect module spec secret but FCC approves

An American Telephone & Telegraph Co. secret technical specification for an Authorized Protective Connecting Module (APCM) for automatic telephone answering equipment to be connected to AT&T lines **has been approved by the Federal Communications Commission despite objections.** The FCC denied a petition by Communications Certification Laboratory to suspend tariff revisions incorporating the APCM by reference only. The laboratory had asserted that abuses by AT&T were a possibility, since determination of the X-74378 technical standard rests solely with the telephone company, and charged the reference was misleading and incomplete, on the grounds that the APCM does not perform all the functions listed.

Addenda

Motorola Semiconductor **is disbanding its watch operations,** though it will continue to sell quartz crystal and C-MOS components. Personnel involved in the operation will return to the semiconductor and marketing areas. . . . The Federal Railroad Administration is funding a three-year test of a new concept in dispatch and control. It will involve two voice and digital contact between engineer and dispatcher, **plus conversion of electro-mechanical signals to electronics.** . . . **Single-customer earth stations** will be featured in the IBM-Comsat General team's proposed digital domestic satellite system if the FCC approves IBM's participation.

Better than any IC or UJT for low cost timing circuits.

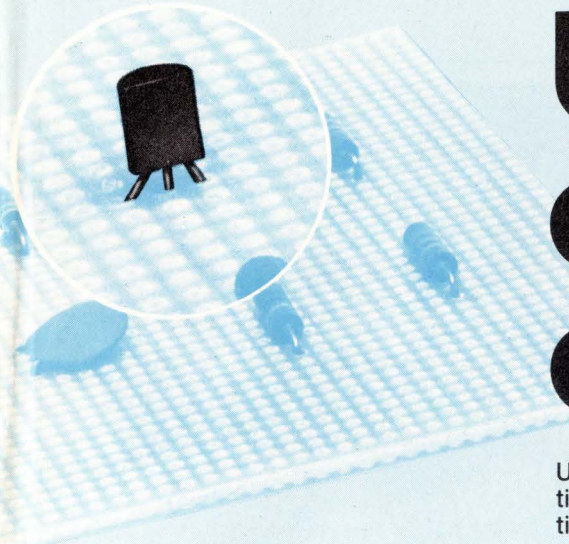

Unitrode PUTs provide design freedom unobtainable with conventional UJTs—at a fraction of the cost of comparable ICs or mechanical timing circuits.

By varying the external resistor values you can program turn-on voltage, turn-on current and turn-off current to meet your needs . . . in timing circuits, oscillators, sensing circuits or any application where a variable voltage level threshold is required.

Unitrode Programmable Unijunction Transistors (PUTs)

Simple, versatile, low cost Unitrode PUTs meet the performance require-

ments of any timing circuit in frequencies from 50 KHz to .001 Hz, from microseconds to hours.

Millions of Unitrode PUTs have already cut costs in thousands of applications from smoke detectors and television sets to office machines and industrial processing systems. In fact, Unitrode produces a larger selection of PUTs than all other manufacturers combined. Fully planar passivated . . . low nano-amp leakage for long interval timing . . . in the plastic TO-92 and TO-98 package, and the hermetically sealed TO-18 package.

Send for a free sample. We'll also include data sheets and application notes to help you breadboard the lowest cost timing circuits ever.

Or, for faster action, call John Upton at (617) 926-0404. Unitrode Corporation, 580 Pleasant Street, Watertown, Mass. 02172.

Try a free sample

Circle 21 on reader service card

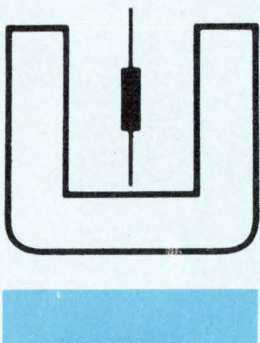

UNITRODE

580 PLEASANT STREET, WATERTOWN, MA 02172

Every time you try a new RF design

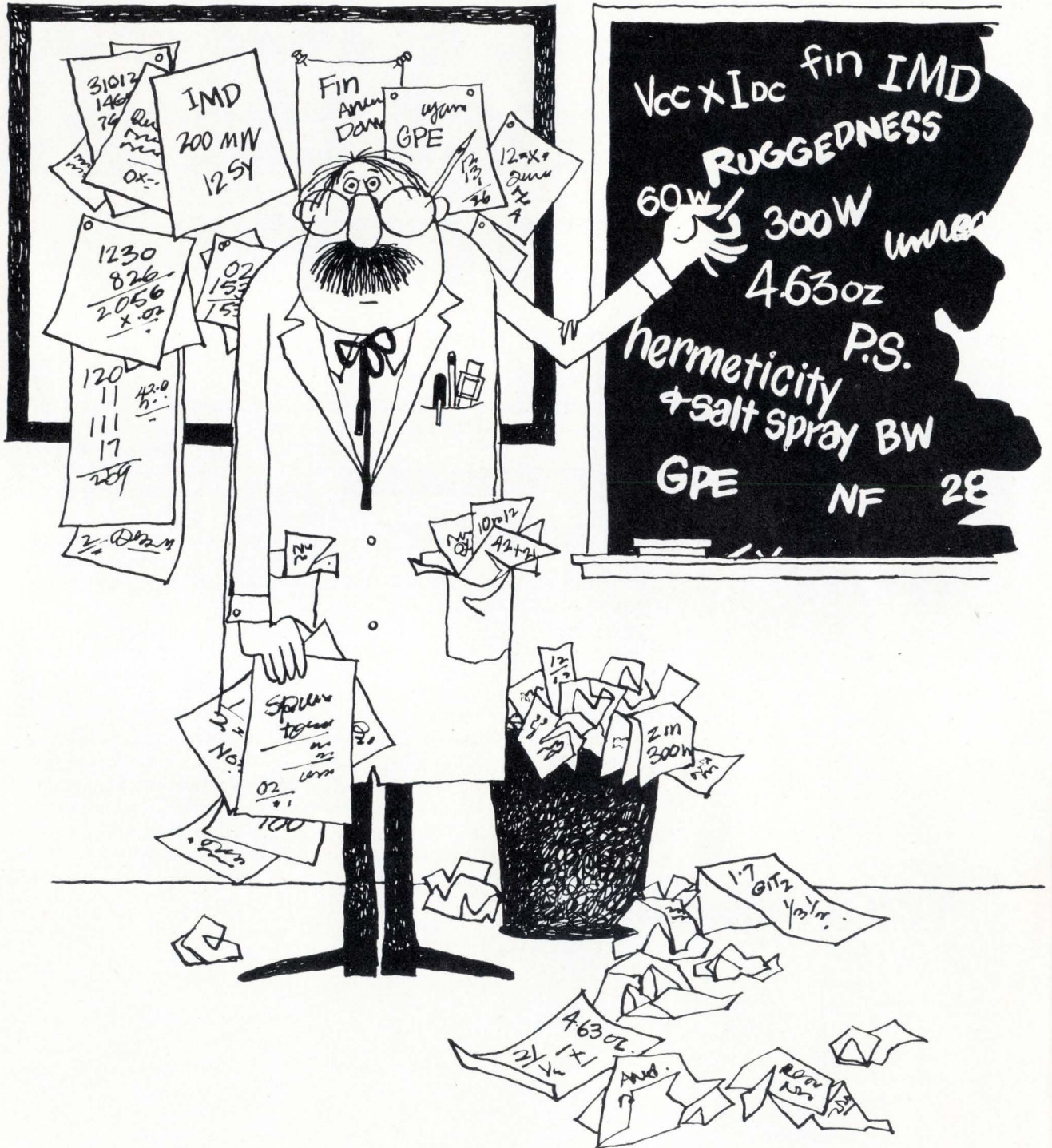

Some expert's giving you advice

Putting together a 300 W amplifier or designing the latest impedance-matching networks for RF power within the project timeframe you're given takes skill — and the kind of backup information supplied by someone who's done it before, more than once, with good results.

Those results are in this new handbook . . . the most comprehensive publication of its type in the industry.

Immodestly, it will help you supplement your RF design skill from P_{in} to P_{out} . Because it contains application notes and engineering bulletins on the latest state-of-the-art. Because it furnishes the broadest offering of RF devices available to 1 GHz. Because its data sheets aren't data sheets but condensed design aids in themselves.

Write on your company letterhead for a little RF_{in} RF_{out} advice: Box 20912, Phoenix, AZ 85036. A Motorola rep will give you a copy when he calls to chalk-talk your RF design needs.

Compiled for experts by experts . . .

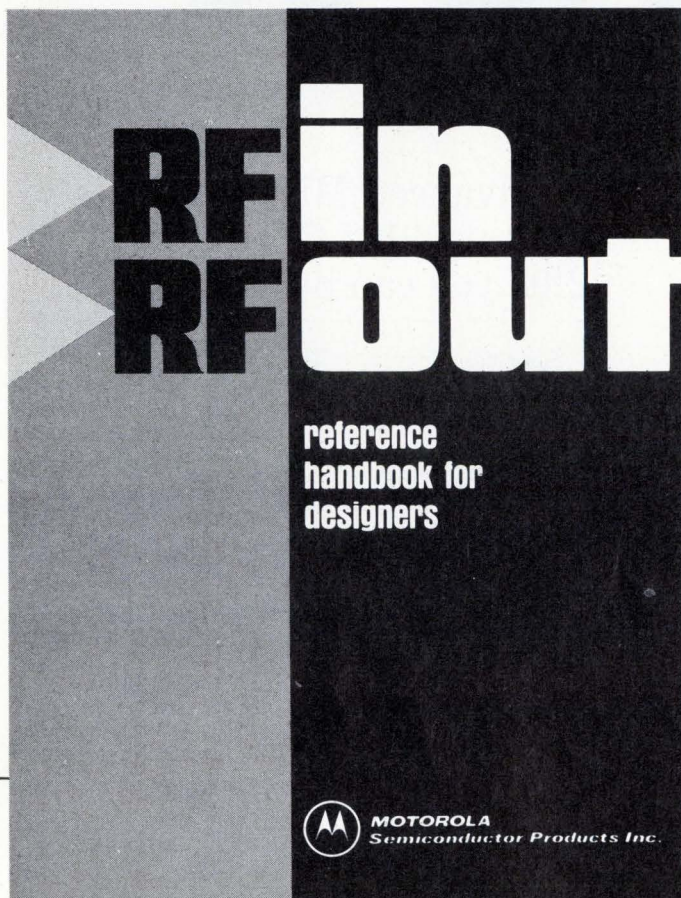

one and only
From Motorola, the RF producer

Military 2102's.

The 2102 is the hottest memory device in the business today.

The only problem is for the military buyer. The 2102 has been out of uniform. Nobody made a Military 2102.

Until now.

Advanced Micro Devices' Military 9102. Every one is MIL-STD-883. Every one is guaranteed over the full military temperature range.

We make a high-speed version, too: the 9102A. With 500 ns. access time.

Advanced Micro Devices' Military 9102. It's the best 2102 you can buy.

<u>Specification</u>	<u>The Am9102</u>
Access Time	Guaranteed .65 μ sec (9102DM) Guaranteed .50 μ sec (9102ADM)
*Stand-by Voltage	Guaranteed 1.6V DC Typical 1.0V DC
*Stand-by Power	Guaranteed 64 mW Typical 16 mW
Power Dissipation	303 mW maximum
Power Supply Tolerance	$\pm 10\%$
Logic Levels	TTL Compatible
Fan-Out	Guaranteed 2 TTL loads

*Retains data above guaranteed voltage.

Advanced Micro Devices

Corporate offices are at 901 Thompson Place, Sunnyvale, California 94086. Telephone (408) 732-2400 or toll free from outside California (800) 538-7904/Southern California office: Beverly Hills (213) 278-9700/Mid-America: Oak Brook, Illinois (312) 323-9600/Edina, Minnesota (612) 835-4445/Eastern United States: Roslyn Heights, New York (516) 484-4990/E. Syracuse, New York (315) 437-7546/Baltimore, Maryland (301) 744-8233/Lexington, Massachusetts (617) 861-0606/Britain: Advanced Micro Devices, Telephone Maidstone 52004/West Germany: Advanced Micro Devices, Munich, Telephone (089) 53 95 88. Southern Europe: Advanced Micro Devices, S.A., Neuilly, France, Telephone: 747-4194. Distributed nationally by Hamilton/Avnet, Cramer and Schweber Electronics.

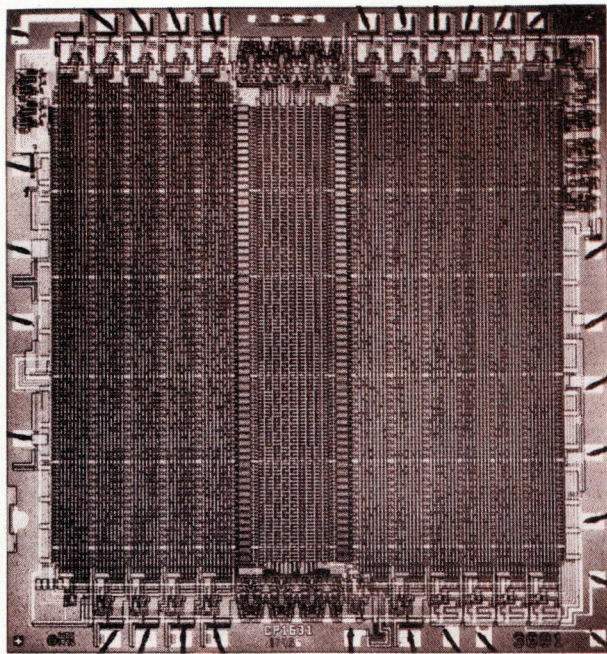

DEC meets micro challenge with three-chip mini

Western Digital applies n-MOS technology to emulate DEC's PDP-11/05; LSI-11 is almost as fast

Moving against hot competition from semiconductor houses and their microcomputers, Digital Equipment Corp., the dominant minicomputer manufacturer, has developed with MOS manufacturer Western Digital Corp. a powerful "computer-on-a-board" chip set. The result is a package with better performance than the single-chip microprocessors, and which emulates DEC's low-end PDP-11/05 minicomputer.

The Maynard, Mass., minicomputer maker is now receiving the first chips developed by Western Digital under a \$6.3 million contract, and will incorporate them in its LSI-11 computer, to be introduced in a few months [*Electronics*, Oct. 17, p. 25].

The three-chip, n-channel, silicon-gate set consists of a data chip, control chip and Microm, a microprogrammed read-only memory (top, left). All are in 40-pin packages.

The set features a 3.3 megahertz clock and 300 nanosecond microinstruction cycle time, permitting it to operate only 10% slower than the bipolar PDP-11/05 minicomputer. The internal data path is 8 bits wide, but the memory port is 16 bits wide, and the computer can handle either 8- or 16-bit data.

William H. Roberts, vice-president of research and development at Western Digital, says the new microprocessor set "allows the user to create an efficient and dedicated instruction set, (and also provides) the ability to expand system operation with a minimum of hardware addition."

DEC chose Western Digital for the work, says Andrew Knowles, group vice president at DEC and general manager of the Digital Components group which will market the LSI-11, because the Newport Beach, Calif., MOS house is oriented to the fast, n-channel process. Moreover, Knowles feels that Roberts knows DEC's PDP-11 line extremely well.

Microprogramming to emulate the PDP-11/05 minicomputer was performed at DEC, and the basic instruction set required two Microms. Fixed-point multiply and divide, and floating-point instructions have

been programmed in a third Microm. Western Digital claims the set can efficiently emulate macroinstruction sets on the order of the more sophisticated PDP-11/40.

Knowles says DEC is moving slowly with the LSI-11, which will be marketed, possibly on a single board, because it wants to be sure the parts work, are reliable, and will be inventoried in quantity. Other minicomputer houses bringing out LSI microcomputers—General Automation Inc., and Computer Automation Inc.—have run into delays with their units because of problems obtaining chips.

The DEC vice president also notes that it may be difficult to get a second source because of the "not-invented-here" factor and the relatively low volume. However, DEC is not distressed at the idea of having only one source; when the top-of-the-line PDP-11/45 was developed, Texas Instruments was the only company that could produce the needed Schottky bipolar devices, Knowles points out, and the program worked out well.

Computer organization. The chip set is arranged to permit selection of various levels of capability. The minimum set would contain one

data chip, one control chip and one 512-word-by-22-bit Microm, with 80 microinstruction operations. Up to four Microms—2,048 words—may be accessed on the fast (200 nano-second) microinstruction bus. Direct memory access is also provided.

The system uses a dual bus arrangement, and an 18-bit microinstruction bus connects the MOS chips (4 other bits are for external controls). It operates in pipeline fashion in that the execution of one instruction overlaps the fetching of the next one. The 16-bit data and address bus communicates with the memory and input-output systems; it is TTL compatible.

The data chip contains the main access port for instruction and data

acquisition, plus the register and logic to perform operations on data and provide status information. It contains 26 high-speed 8-bit registers, an 8-bit arithmetic logic unit, and a microinstruction register.

The control chip provides program control by interpreting macroinstructions and generating starting addresses for associated microinstruction routines. It also provides control and timing signals. The control chip recognizes seven interrupt signals, which can be programmed to the desired priorities.

Western Digital will supply the set only to DEC, but it is also working on a single-chip microprocessor of its own design. This will not be ready until next spring. □

Packaging & Production

Role of conductive elastomers expands to p-c boards and connector designs

Working with conductive elastomers, the rubber-like silicone material in which suspended metal particles conduct electricity, a consultant in Glastonbury, Conn., says he's developed a trio of interconnection schemes that greatly simplify the fabrication of printed-circuit boards, wire-wrap-equivalent panels, and electrical connectors.

Emik A. Avakian, head of Avak-

ian Systems Development Co., says that for printed-circuit boards, the elastomer is formed into short, pellet-like cylinders, which are plugged into the holes in the boards, as shown below, left. Component leads are fastened to a board simply by pushing them into the pellets.

The springy, elastomeric material, a proprietary mixture, holds the device pins firmly in place, eliminat-

ing, says Avakian, the need for device sockets and plated-through holes, as well as soldering or wire-wrapping. A "head" on each end of the pellets contacts the conductive pads on either side of the board. And, in some applications, the material's high heat-conduction allows heat sinks to be eliminated, he says. Until now, conductive elastomers have been restricted to use in custom microcircuit interconnections in such devices as watches with liquid crystal displays [*Electronics*, Sept. 19, p. 122].

Contact resistance between a pellet and an embedded component pin is low—usually less than 15 milliohms. And if a component is removed and re-inserted as much as a dozen or so times, the contact resistance will increase by only a few milliohms. Moreover, each pellet can carry at least 3 amperes of current with no increase in temperature. The pellets are also self-healing, so that when a component is withdrawn, there is almost no sign of the holes made by the pins.

Interconnecting panels. Avakian calls a printed-circuit board outfitted with his pellets a component-interconnecting panel. Pellets can be either molded in place, or they can be formed separately and cured in a long string with their heads connected by a nonconductive webbing. The pellets are then pushed into the board holes in much the same manner as conventional p-c connector

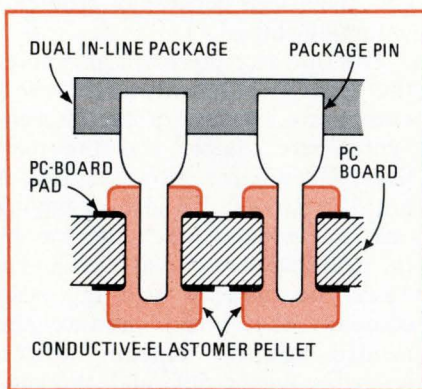

Push to mount. Conductive-elastomer pellets inserted in the holes of a p-c board do double work. They contact the board's pads without soldering, and they hold the components securely in place.

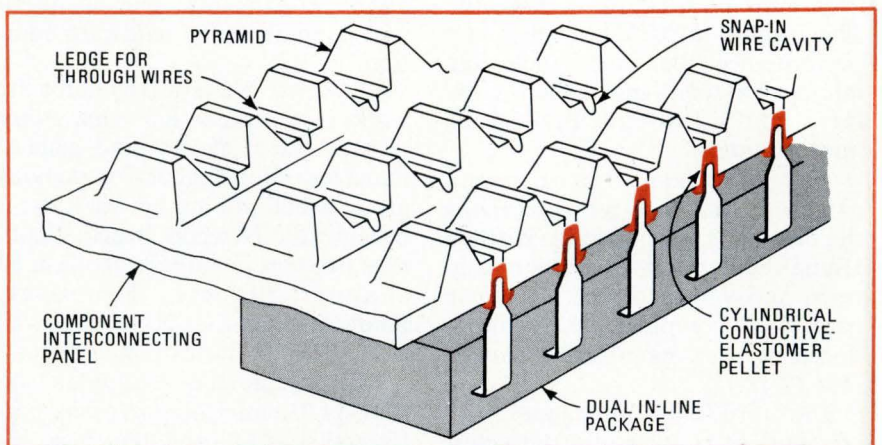

No wirewrapping. Molded plastic panel has a matrix of pyramids and channels interspersed with through holes. Conductive-elastomer pellets contact and hold component pins, while the channels act as guides for the insulated interconnecting wires.

pins are staked into a board.

Another type of interconnecting panel that Avakian has developed is essentially an equivalent for wire-wrapped panels. The panel itself is molded from a dimensionally stable plastic, such as Valox or ABS. On its component-mounting side, there is a matrix of holes, with centers spaced on a 100-by-300-mil grid. Each hole has a shoulder that prevents a pellet from being dislodged after it has been inserted and cured. As with the other panel, these pellets are cylindrical, too, and component pins are pushed directly into them.

However, on the other side of the board, as shown at the right of page 26, is a molded array of pyramids and channels. Interconnecting wire, stripped at its ends, is pushed into a pellet and its insulated portion snapped into a cavity at the channel's bottom. The cavity, designed for #30 American Wire Gage wire, provides the same holding force as is required to pull a wire from a conventionally wire-wrapped post. For a through interconnection, the wire is led upward from the snap-in cavity to a ledge along which it runs through the channel.

Avakian is also applying the elastomer pellets to general-purpose connectors. There are no male or female parts in these connectors. Instead, both halves look identical. They are outfitted with elastomer pellets protruding slightly above each connector face. Connecting wires run in through the back of each connector half and are embedded in the pellets. The holes for the pellets are tapered to make a reliable, strong contact between the pellet and the embedded wire. No special crimping tools are needed. The connector can be mated simply with a clamp or other mechanism that pushes both halves, and the embedded pellets, against each other.

Avakian is considering manufacturing some of his systems himself, and he hopes to offer licenses through Epis Corp., another firm in Glastonbury. He will manufacture and sell his conductive-elastomer material. □

Semiconductor market outlook flat for '75

Almost no growth is projected for next year in the world-wide semiconductor industry, although sales of metal-oxide semiconductors will continue to rise. Total world-wide sales will increase to \$4.877 billion in 1975, an increase of less than 2% from a \$4.806 billion level in 1974.

These are the conclusions of a market forecast made at the Fourth Annual WEMA Monterey Conference for financial analysts in Monterey, Calif., last week. WEMA is a Palo Alto, Calif.-based association of companies in the electronics industries.

"It may be a gloomy forecast but it's realistic," says Robert Noyce, president of Intel Corp. and chairman of the recently formed WEMA Semiconductor Group which sponsored the study. With no industry-wide market figures available for semiconductors, it seemed logical for WEMA to step in, explains Noyce. WEMA will update its forecast every three months. The conclusions reflect the views of a dozen semiconductor manufacturers—Motorola Semiconductor and Texas Instruments not included—who furnished estimates and companies who gave their reactions to the figures.

The consensus is that the total market will remain essentially flat through the first half of 1975, then start picking up in the third quarter and improve somewhat faster during the fourth quarter. But it won't be until 1976 that the growth rate nears the 1974 level of 14% to 15%.

The improvement will be due primarily to demand for MOS, especially n-channel memory, according to the study. The total MOS market will grow by 12% in 1975 to \$815 million, then by 31% in 1976 (to \$1.096 billion) and by 30% in 1977 (to \$1.387 billion).

Most seriously in decline will be consumption of discrete devices, with a 3% drop to \$2.552 billion predicted for 1975. Sales will improve somewhat (perhaps 8%) in 1976 but will decline again (by about 6%) in 1977.

Avionics

Cockpit voices are for pilot's good

The passengers probably won't be aware of it, but there may soon be a booming voice heard in the cockpits of high-flying jets. The voice will call attention to possible trouble aboard the craft, and in unmistakable terms.

The new system, with a digitized vocabulary of 25 words, is being developed by McDonnell Douglas Electronics Co., St. Peters, Mo. And if the airlines buy it, the first application could be aboard parent McDonnell Douglas Corp.'s DC-10 jets.

Aural-visual signals already are used to alert pilots to problems such as reduced cabin pressure or engine fires, but the sounds are produced by various bells, tones and buzzers. Fortunately, the pilot hardly ever hears them outside of an aircraft

simulator, but this also creates a problem: the pilot may not recognize which warning is being sounded. He may have to scan the cockpit instruments for the warning light that goes with the tone.

The voice backup is being developed to reduce the time for interpreting the malfunction signals. It is a retrofit package to be added to the tone warning system—called Central Aural Warning System (CAWS)—which is already flying aboard the DC-10s. The messages are advisories, not commands. For example, if the plane is equipped with a ground proximity warning system, the message might be "too low" rather than "pull up." Warnings include "overspeed," and "landing gear." There are also messages for engine fires and take off warnings like "slats," "flaps," "spoiler," and "stabilizer."

"There are a number of techniques available for voice synthesis, but we are faced with severe packaging constraints here," notes William W. Sang, manager of digital communications in McDonnell Douglas Electronics' new product

development division. "The only space available is about 2 by 2½ by 8 inches."

Sound stripper. So McDonnell Douglas digitizes the 25 words needed for 16 warnings and uses a proprietary technique for stripping the sound to the minimum necessary for transmitting information to the pilot. "We take a 'voice print' to

digital-to-analog converter to yield the audio output. An audio amplifier and power supply are also built into the voice warning system.

Cost is not low. A system built to supplement the DC-10's CAWS package would sell for about \$5,000 in volume, says Ronald M. Schutz, the company's marketing manager for commercial airlines. Planes not

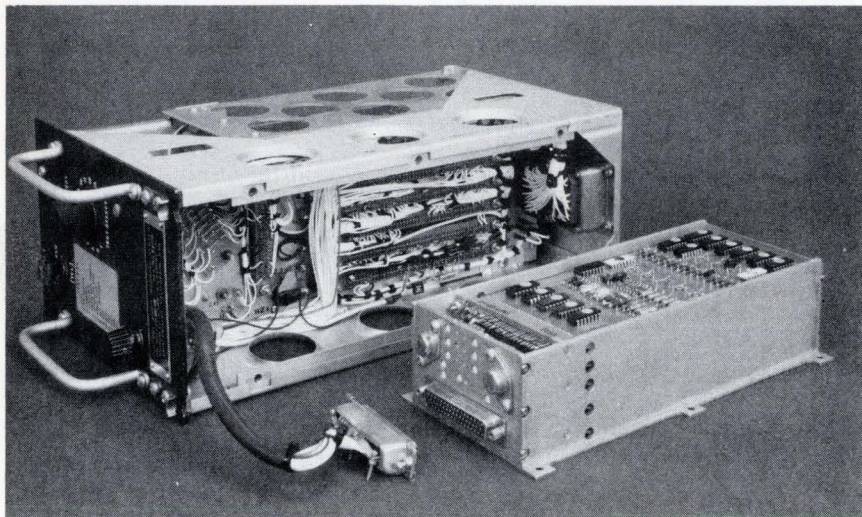

Voice box. McDonnell Douglas has squeezed a 25-word voice synthesizer onto three circuit boards that can fit into the central aural (tone) warning system aboard DC-10s.

identify the energy content of the word in terms of frequency and amplitude, and use a computer to throw away a lot of the redundancies in speech," he says.

"Straight digitizing of voice takes about 64,000 bits per second, or about 32,000 bits per word," he adds. "We've found that we can massage it down to about 600 or 700 bits per word. We pay a penalty, of course: the sound is less natural, more monotonic, and sounds like a computer talking."

The words are stored in six 5,128-bit silicon-on-sapphire read-only memories built by Rockwell Microelectronics—a type McDonnell Douglas had been using.

Extra space on the ROMs contains each word's discrete address and the necessary logic to start and stop the sound. In addition, the three printed-circuit boards that make up the package provide the circuitry for synthesis of the bits into sounds—essentially a hybrid active filter—and a

equipped with CAWS would require additional interface and buffer circuitry. Single-word systems, to go with terrain-avoidance systems such as the one marketed by Sundstrand Corp. [*Electronics*, Oct. 3, p. 46] would be tagged at less than \$1,000.

KLM and Swissair have evaluated the voice warning system for DC-10s both in flight and in simulators; American Airlines used it in simulators for six months at its Ft. Worth, Texas, training center.

The McDonnell Douglas unit is not the first to give voice warning to commercial pilots. For ground-based purposes, Sperry Univac division has built a digital voice response unit for the Federal Aviation Administration's National Aviation Facilities Experimental Center near Atlantic City, N.J. [*Electronics*, August 30, 1973, p. 32]. Nafec wants to automatically advise pilots on the location and altitude of nearby aircraft, as well as fixed obstacles like TV transmitters. □

Memory

Mass store holds 4 trillion bits

The recent announcement of IBM's 3850 mass storage system had two important ramifications. It revealed IBM's continued interest in a market in which IBM had announced no new products for several years. And it unveiled a memory with a capacity of almost 4 trillion bits—well beyond the trillion-bit level designers of the latest generation of mass memories have been shooting for [*Electronics*, Feb. 14, 1972, p. 91].

With big enterprises such as banks and insurance companies requiring large data bases, the need for mass storage has become more and more urgent. The new virtual system operates with IBM's 3330 magnetic-disk store. But the new system's control, a new model of the IBM 3830 disk-store controller, is so arranged that the computer can address up to 64 disk drives, whereas a maximum of 32 drives can actually be connected through the IBM 3330's controller. The balance is supplied by the new system, which consists of small magnetic-tape cartridges four inches long and two inches in diameter. Each holds 50 million characters on a 770-inch length of magnetic tape rolled up inside the cartridge.

Two cartridges have the same capacity as one of the original 3330-type disk packs, or four cartridges for the newer "double-density" packs. Up to 706 of these cartridges are stored in honeycomb-like cells in a frame that also houses the control unit (up to three additional increments of 1,338 cells each can be added to a single system).

Less expensive. The system can store a maximum of 472 billion characters—almost 150 times the capacity of the largest IBM-3330 disk store. And the memory is available at about one tenth the cost of disk storage, according to IBM.

Under program control, an access mechanism plucks the cartridge out of its cell, and transports it to a data-recording station; data is transferred between the cartridge and the disk file, and the cartridge is returned to its cell. Once in the disk file, the data is available to the computer.

IBM says the data on the tape is organized in cylinders in a manner analogous to the way cylinders are organized in a disk pack. But precisely how this is done is proprietary. By means of a rotating head, the data is recorded on the tape along helical "stripes." Synchronization and control tracks lie along the edge of the tape. One of these diagonal stripes stores 4,096 characters. Sixty-seven stripes contain one cylinder image and therefore correspond to the 19 tracks that compose one true cylinder on a disk pack. IBM won't say how 19 tracks were arranged on 67 stripes, other than to point out that one stripe does not consist of 19 parallel tracks angled across the tape. IBM would not disclose the recording density either.

The access time of the 3850 is exceedingly slow. The time to fetch a cartridge out of a cell ranges from 3

Tape store. Small two-by-four-inch tape cartridge in new IBM 3850 mass store contrasts with older disk pack seen in the rear.

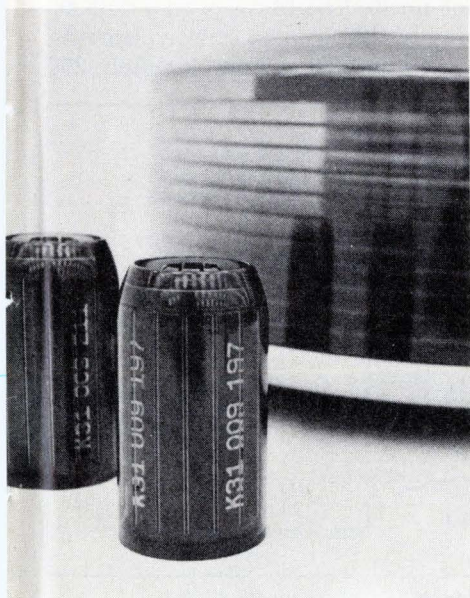

to 8 seconds, depending on the total capacity and how far the access mechanism has to move to reach an addressed cylinder; loading the tape onto the data-recording device, winding it back into the cartridge, and returning the cartridge to its cell take 5 seconds each, for a total of perhaps 23 seconds. However, while the tape is on the data-recording device, a specific cylinder is located by a high-speed search; thereafter, data transfer takes place at the respectable rate of 874,000 characters per second. □

Consumer electronics

TI defers its watch entry

Texas Instruments has postponed its entry into the digital-watch market until early next year. It has canceled orders with Motorola Inc. for quartz crystals and with four other suppliers of watch cases and bands. However, TI has been offering several traditional watchmakers TI-fabricated digital modules for use in their own models.

TI's actions have caused confusion among its would-be competitors and dismay among retailers, many of whom have had considerable success with the Dallas-based semiconductor giant's calculators. Retailers had hoped to be selling TI's digital watches by the end of the year.

Although suppliers aren't very happy about the cancellations, they seem confident that TI will be back buying—possibly by the end of the year—after officials rethink the consumer-watch program. TI is refusing to explain the cancellations, which started with telephone calls to the suppliers, followed by crisply worded telegrams to request immediate cancellation of orders and immediate acknowledgement of the cancellations.

TI indicated to some of the suppliers in follow-up calls that the cancellations were caused, at least partially, by dissatisfaction with the

esthetics of the present TI watch design. One of the common complaints by consumers is that digital watches are too bulky. TI's model, says a source, is oversized.

Calls. One of the first to hear from James L. Crump, TI's watch parts buyer, was Motorola, which already had begun deliveries of its quartz crystals. This was followed by calls to Benrus Watch Co., Ridgefield, Conn., I. D. Watch Case Co., New York City, and Hamilton Technology Co. in Lancaster, Pa., a subsidiary of HMW Industries Inc., to cancel watch-case orders. Sheldon Parker, president of WMR Watch Case Co., New York City, received a cancellation of an order for watch bands.

W. Kent Wise, Hamilton Technology's vice president, says, "We haven't had a full explanation from TI, but we're sure we'll get one. We've had a very good vendor relationship, and we think that they'll continue to be good customers for us over the years."

Parker of WMR says he understands that TI still plans to enter the market with its watches early next year. "And when they get in," adds Parker, "they'll be in big. The company has always been a leader in its field, and I'm sure they'll be a leader in the watch market."

No one is prepared to dispute this, even though the company must be considered a late entry into the digital watch market. However, estimates of U. S. sales for next year range up to 3 million units, and at least one knowledgeable source is convinced that TI is gearing up to place some 750,000 watches on the market in 1975.

OEM mystery. What several view as more interesting is TI's apparent effort to enter the market on an OEM basis, selling to traditional watchmakers and well-placed entrepreneurial marketers. Several of these firms have reportedly been contacted in the past few weeks by Wendel Harrison, manager of consumer-market development for TI's Semiconductor group. All of Harrison's calls were aimed at setting up appointments for presenta-

tions of TI's watch modules.

Aesthetics aside, some TI observers simply feel the company may not be able to pump out watches in very large quantities, preferring instead to get a position in the OEM market against the likes of Hughes Microelectronics, RCA Solid State division, Optel Corp., American Microsystems Inc., and Integrated Display Systems Co. Also, TI is using the new integrated-injection-logic chip in its watches, which some sources believe may be causing delays because yields could be low. Other manufacturers are using complementary-MOS.

Another theory behind TI's reticence, another source says, may be found in the company's recent unannounced shift of its watch operation from the Calculator division to its Equipment group, which develops much of TI's custom-production equipment. "It's likely," says the source, "that TI may be behind with its assembly operation." □

Solid state

CCD image arrays get own amplifier

One problem holding back image applications of charge-coupled devices is that the image signal is often obscured by relatively high device noise—especially troublesome for

low-light-level uses. Two years ago, engineers at Fairchild Semiconductor suggested that a new type of amplifier was needed to improve this low signal-to-noise ratio. Now the company says it has one—a distributed floating-gate amplifier (DFGA) that it claims is the first truly CCD-compatible amplifier.

The 12-stage device boosts the s/n ratio while using well-understood MOS LSI technology, according to Gilbert F. Amelio, director of charge-coupled devices, Fairchild Research and Development division, Palo Alto, Calif. It can detect low levels of light down to 60 electrons.

In two years, predicts the bullish Amelio, there'll be TV-camera-sized arrays, four times larger than anything being made now. Size has been limited because the bigger the array, the poorer the s/n ratio.

But Amelio acknowledges that CCD arrays will have to surpass conventionally used vidicon tubes in performance, perhaps by offering 10 times the resolution for only six times the cost.

According to Amelio, a major problem with conventional amplifiers is that "you take the CCD signal and dirty it with an old-fashioned amp." The low-noise, high-sensitivity DFGA, along with a gated-charge-interrogator type of detector-preamplifier, is incorporated into a CCD array which employs buried-channel design. As Amelio describes it, the input to each of the 12 stages

is a floating gate located over the CCD channel. Charge packets passing through the channel under the floating gate are non-destructively sensed by capacitance coupling which modulates an associated MOS transistor. A second CCD channel synchronously collects the outputs amplified by the MOS transistor.

Gain. Thus, the DFGA concept is based on the CCD's ability to pass a signal charge under successive sensing electrodes with no signal degradation. By repeatedly sensing the signal charge, it is also possible to improve the power signal-to-noise ratio relative to a single-stage amplifier by the number of times the signal is sensed.

Reconstruction of the signal within the time domain can be automatically obtained by summing the amplified signals in the second CCD register. Amelio adds that "you get all that gain without giving up bandwidth."

The 12-stage DFGA has four functional parts: an input register, a bank of charge amplifiers with floating-gate inputs, an output register, and an output amplifier (below, left). Inverting amplifiers are between the two registers, while a floating-gate output amplifier is used also. A four-phase register-clocking concept provides maximum flexibility in clocking; the two registers are driven by the same set of clocks. The DFGA is on a CCD array of 190 by 244 sensor elements. The amplifier is approximately 250

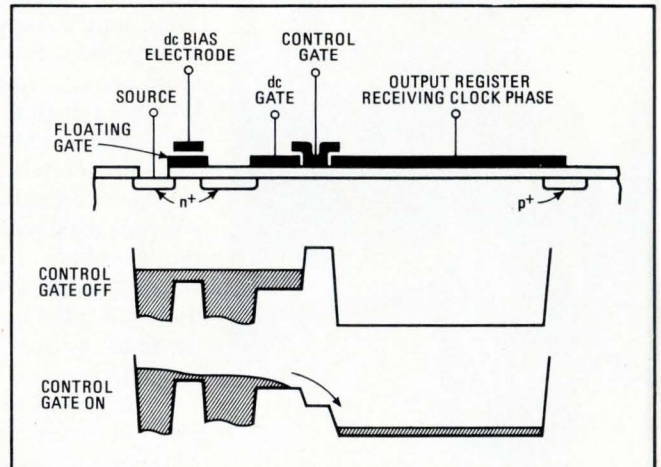
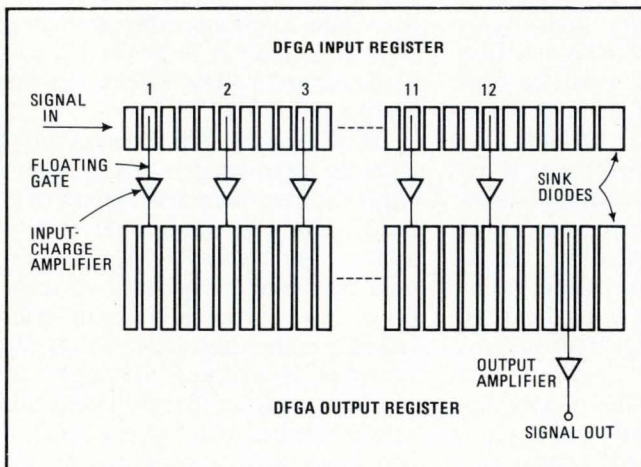

Amplifier. Twelve-stage amplifier for image arrays, left, is compatible with CCD technology. Single-stage cross section is at right.

10-bit monolithic CMOS DAC.

And now with 12-bit resolution.
AD7521.

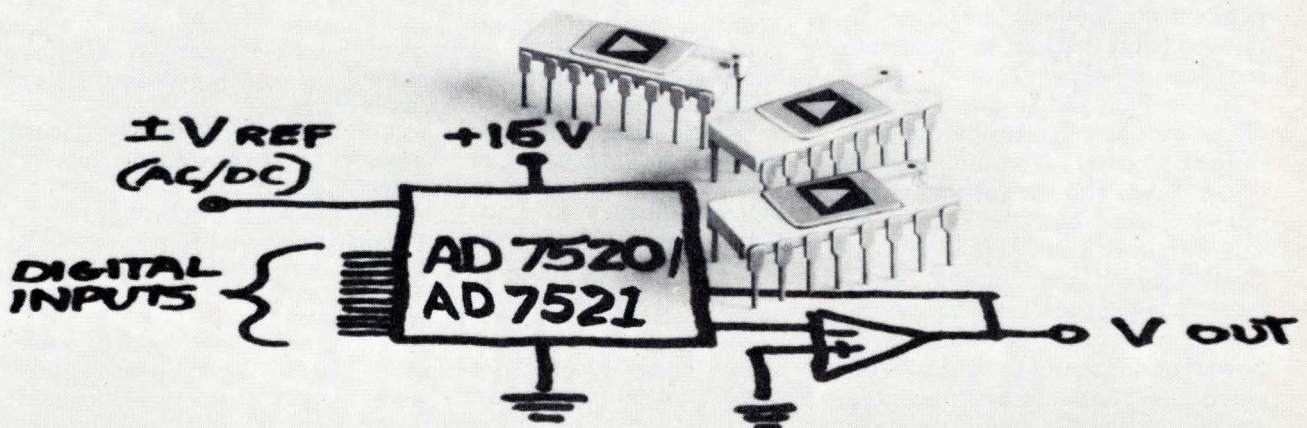

True 10-bit accuracy.

0.05% max. nonlinearity over $\pm V_{REF}$ range.

2 ppm/ $^{\circ}C$ max. nonlinearity temperature coefficient.

10 ppm/ $^{\circ}C$ max. gain temperature coefficient.

Low power consumption.

20mW power dissipation.

Versatile — like two DACs in one.

A straight (unipolar) converter.

2 quadrant multiplier.

4 quadrant multiplier.

AC/DC reference.

CMOS and TTL/DTL compatible.

Variety. Three versions at economy prices.

16-pin DIP AD7520 and 18-pin DIP AD7521 are available in 8, 9, and 10-bit accuracy versions. Priced from \$12 in hundreds. Available in plastic and ceramic.

To order, give us a call.

East Coast: 617-329-4700

Mid West: 312-297-8712

West Coast: 213-595-1783

CMOS DAC is just another innovative use of advanced technology to keep you — and us — a step ahead of everyone else.

From Analog Devices, Inc.,
Norwood, Mass. 02062

 **ANALOG
DEVICES**

by 400 micrometers, about as large as a single CCD element.

One stage of a DFGA, says Amelio, consists of a source, a floating gate, a bias electrode, a control gate, and a gate which minimizes clock coupling from the control gate to the floating n^+ diffusion (diagram at right on p. 30). Charge control is influenced by the potential-well profiles. During the time that a signal charge packet in the input register is under a floating gate, the control gate is pulsed "on" for a precise time interval. During this time, a small fixed charge and a signal-dependent current flows; the larger the initial charge packet, the less current flows, he says.

In the Fairchild DFGA, over half of the area is taken up by the CCD output register. The number of DFGA stages and the saturation input level determine the size of the CCD output register. Amelio says no clearly defined optimum number of stages has yet been set. The s/n ratio increases as the one-fourth power of the output register area, since the fundamental principle shows that the s/n ratio in voltage improves as the square root of the number of stages and since the size of each stage of the output register must be increased linearly as the number of stages increases. □

Displays

Film transistors trigger display

"We're probably the only major group in the country that hasn't given up on thin-film transistor technology," observes T.P. Brody before describing the flat, television-like display screen he's developed at Westinghouse Research Laboratories, Pittsburgh, Pa. [*Electronics*, Oct. 17, p. 26]. The screen was developed with funds from both Westinghouse and the U.S. Army Electronics Command, which is interested in a lightweight portable message display that could be car-

ried by troops in the field.

"Screens made with the thin-film transistors will be rugged, long-lived, inexpensive, and will require little power," says Brody. Other Westinghouse scientists who work with him on the project are F.C. Luo, Z.P. Szepesi, and D.H. Davies.

Brody, whose group has also made a display using liquid crystal instead of electroluminescent mate-

rial, predicts that "thin-film screens for information display might be available by 1976." However, he tries to discourage "ambitious speculations" regarding the possibilities of the thin-film screen. "There are no Westinghouse plans for a panel that could operate at full TV capability and resolution," he says.

The prototype screen, which is six inches square, provides a resolution

News briefs

Anti-inflation move in Old Saybrook holds price line

Conrac Corp.'s Cramer division, Old Saybrook, Conn., seems to be taking President Ford's anti-inflation program to heart. Cramer says it will now guarantee its prices for six months after receipt of orders. At intervals, the firm says it will use the federal government's monthly economic indicators for labor and materials rates to adjust its prices.

"If the indexes go down, so will our prices," says Clifford R. Gasparini, general sales manager of the division, which makes magnetic tape products, security and detection equipment and timing devices, among other products. "If the indexes go up, we will raise our prices by only two-thirds of the average increase of these indexes since our changes will represent only a pass-through of material and labor costs, not additional profit."

More layoffs in the electronics industries

Texas Instruments, Dallas has laid off about 2,000 employees at overseas semiconductor production facilities—1,000 in Singapore and 1,000 in Taipei, Taiwan. In Chicago, the Admiral group of Rockwell International Corp., has laid off 2,200 production employees at four Home Entertainment division plants. Both companies gave the same reason for the layoffs—the need to balance inventories with market demand.

General Automation tackles business market . . .

Jumping out of its traditional role as an industrial automation specialist, General Automation Inc. has entered the busy and lucrative data management market. It has combined hardware based on its SPC-16 minicomputer with newly developed software packages for application to financial planning, manufacturing job costing and inventory control. The prime marketing thrust of the Anaheim, Calif.-based company will center on the first-time user, although major, multi-programing systems will also be available.

. . . while Sweden's Saab-Scania enters the U.S. banking field

Saab-Scania, the billion-dollar Swedish high-technology company, has organized a New York-based subsidiary, Datasaab Systems Inc. to concentrate on introducing automated banking systems in the U.S. Built around Saab-Scania-designed minicomputers, the system—more than 10,000 teller terminals and 2,500 minicomputers are in the field—has been sold throughout Europe, according to the company.

Sony in the Smithsonian: early products acquired

With its image firmly established in the U.S. marketplace, Sony Corp. of Japan has moved to occupy a place in American history as well. This month it presented 16 of its early solid-state devices and products to the Smithsonian Institution in Washington. Among the components acquired are the first transistor used in a Sony radio (1954); an npn radio transistor grown that same year; two tunnel diodes designed in 1959 by Leo Esaki, who shared the 1973 Nobel prize for physics, and a later Esaki radio diode. Early Sony products presented include the first transistor radio made in Japan (1955) and a 1958 color TV which uses the one-gun Trinitron system.

From the
voltmeter
house...

Here's how we tested our 42,386th multimeter.

The world's best-selling 3½ digit multimeter is virtually indestructible.

Recently, two Fluke quality control engineers wanted to know if our 8000A 3½ digit multimeter would survive a fall from a 24-foot rack. We were shipping several to a phone company.

So they tossed one out the window. Two stories up. It still worked.

But 9944/100% of these out-of-the-ordinary tests we **don't** instigate.

They just seem to happen.

Our president talks about the time he picked up an 8000A at a trade show without knowing it was ready for case removal. The works crashed to the floor but it still played perfectly . . . to everyone's delight and the president's relief.

One reason why our DMM is so tough: it only has 99 parts. Major analog and digital circuitry are on LSI chips.

It's also flexible. This DMM has 26 ranges, including five ranges of ac and dc volts, five ranges of ac and dc current, and six ranges of resistance. And it's the only DMM using an A-to-D converter with inherent self-zeroing to completely eliminate offset uncertainty.



But it's the ruggedness that really makes the 8000A a conversation piece. Our sales force still laughs about the Fluke salesman who was so hot to make a sale that he took his Fluke multimeter and brought it down—crash!—right on his prospect's desk.

"See," he said, "it's really tough."

And so it was, but the op amp that was hidden under a pile of papers wasn't. P. S.—our salesman didn't make the sale.

On a more positive note, a UPS truck accidentally backed over an 8000A not long ago . . . without ill effect.

So there you are. The world's largest selling 3½ digit DMM. And the toughest. And for \$299 it could be yours.

For data out today, dial our toll-free number, 800-426-0361

In the continental U.S., dial our toll free number 800-426-0361 for the name and address of your nearest local source. Abroad and in Canada, call or write the office nearest you listed below, John Fluke Mfg. Co., Inc., P.O. Box 7428, Seattle, Washington 98133. Phone (206) 774-2211. TWX: 910-449-2850. In Europe, address Fluke Nederland (B.V.), P.O. Box 5053 Ledeboerstraat 27, Tilburg, The Netherlands. Phone 013-67-3973. Telex: 844-52237. In the U.K., address Fluke International Corp., Garnett Close, Watford, WD2 4TT, England. Phone 0923-33066. Telex: 934583. In Canada, address ACA, Ltd., 6427 Northam Drive, Mississauga, Ontario. Phone 416-678-1500. TWX: 610-492-2119.



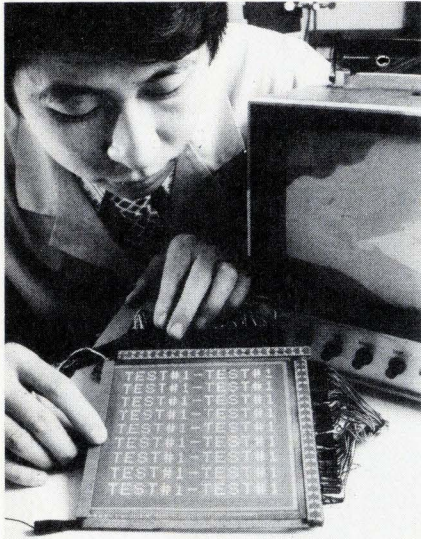

On display. Westinghouse's F.C. Luo holds flat panel in which electroluminescent elements react to thin-film-transistor array.

of 20 lines per inch. Basically, Westinghouse starts with a pane of glass on which it deposits an X-Y matrix of pairs of thin-film transistors and an associated storage capacitor. This trio acts as the switching and storage circuit for each element.

Semiconductor. Cadmium selenide, the active semiconductor material, is deposited through electron-beam evaporation in a vacuum chamber. In addition to the CdSe, Westinghouse also uses various metals, for bus bars and metalization paths, Brody says. An aluminum oxide is also deposited in places to act as an insulator.

Depositions completed, the panel is removed from the vacuum chamber, and the entire active surface is sprayed with an electroluminescent phosphor. An evaporated layer of gold and lead oxide forms a transparent top electrode, and the screen is covered with a thin layer of protective glass.

The basic circuit, repeated at each picture element, consists of an X-Y-addressed logic transistor, a power transistor, and the charge-storing capacitor. Both transistors are field-effect devices. Brody points out that the entire circuit can be fabricated in a single pump-down evaporation. Since material sources and masks are changed for each step from out-

side the vacuum chamber, the process lends itself to automation.

The entire matrix consists of 120 rows and 120 columns, each activated by its own lead. The Brody group is also working on a solid-state scanner that would fit along two edges of the screen and reduce the number of leads to 15 or less.

Operation. The screen operates at 125 volts, and the entire panel consumes less than 250 milliwatts. When the transistors at a row-column intersection are activated, the phosphor glows in the oblong area that's in contact with the output-pad metalization at the drain of the power transistor. Combinations of such oblong "dots" make up the alphanumeric characters.

Westinghouse is trying to increase the resolution of the screen to 30 lines per inch and to adapt some of the auxiliary circuits required by the screen to thin-film design. □

Communications

News fax goes via satellite

Some publications will go to any lengths to get a story out, but it's doubtful that any has gone as far as the Wall Street Journal—more than 45,000 miles. The Journal's publisher, Dow Jones & Co., New York, has been experimenting with the Intelsat IV satellite, parked above the mid-Atlantic Ocean, to transmit facsimile information from the newspaper composing room in its Chicopee, Mass., printing plant to a "slave" printing plant in South Brunswick, N.J. Using equipment and satellite facilities provided by Comsat Corp., Dow Jones has been printing individual pages of the eastern edition of the newspaper for the past couple of months.

Dow Jones and Comsat demonstrated the feasibility of the system about a year ago by transmitting and receiving signals back at the same location, at Comsat's laboratories in Clarksburg, Md. Since

then, the two companies have implemented the system now in use.

The system uses earth stations with 15-foot antennas located directly on the grounds of the two plants. Newspaper-size pages are transmitted in an average time of about six minutes. "The special feature about the system," says Comsat's George Dill, "is that there is nothing special. We're using pretty standard hardware, with one exception—the digital communications terminal, which we call Dicom." The Dicom terminal, which interfaces with the earth-station equipment and the facsimile hardware, incorporates standard four-phase phase-shift-keyed digital modulation hardware and also forward-error correction circuitry for the 50-kilobits per second data rate. When framing and error bits are added, the rate goes up to 66 kb/s, which is sent in a 38-kilohertz bandwidth.

Error check. Coding is added at the transmitting end to allow the receiver to detect most transmission errors and correct them without having to ask for a retransmission. "From the tests we've seen on the satellite," says Dow Jones' Glen Jenkins, "we know we can achieve error rates better than 1 in 10^{10} ." Since no return channel is required from each printing plant, these results increase Jenkins' confidence that the system will work in a broadcast mode, where the same information is sent to multiple slave printing plants in a region.

Dow Jones has nine printing plants around the country and plans to add a tenth next year in Orlando, Fla. The company says it hopes to be in Orlando via satellite but to do so will require them to go to one of the three currently operating domestic carriers—RCA Global Communications Inc., (which is using Telesat Canada's Anik II), Western Union Corp., or American Satellite Corp. (which is using Western Union's Westar). The company will also have to get FCC approval to operate the earth stations.

The experiments end October 31, when the FCC developmental license, granted in August, expires. □

We're not going to make extravagant claims for our 38 new circuit modules. Their performance will prove their value. We're simply going to show them to you. Tell you that they include 3 new multiplying DAC's, 2 new buffered integrating ADC's, a new QZ DAC and ADC, 3 new sample/hold amplifiers, a new fast settling op amp, 8 new V/F-F/V converters, 4 new multiplier/dividers, 4 new log modules, 2 new power supplies, 2 new ultra fast current DAC's, 4 new very high speed ADC's and 3 new multiplexers (2 are monolithic chip). They're all available now for immediate delivery. The price is good in singles, great in 100's. If you want more information fast, drop the coupon in the mail today.

We said 38 new circuit modules . . .



Here they are:



TELEDYNE PHILBRICK 411610
buffered 8-bit A/D converter

TELEDYNE PHILBRICK 4070
high speed 8-bit multiplying D/A converter

TELEDYNE PHILBRICK 411710
buffered 2.5 digit bcd A/D converter

TELEDYNE PHILBRICK 4071
high speed 10-bit multiplying D/A converter

TELEDYNE PHILBRICK 4131
bit A/D converter

TELEDYNE PHILBRICK 4133
2.5 μ s. 12-bit A/D converter

TELEDYNE PHILBRICK 4039QZ
12-bit D/A converter

TELEDYNE PHILBRICK 4366
log ratio module

TELEDYNE PHILBRICK 4072
high speed 12-bit multiplying D/A converter

TELEDYNE PHILBRICK 4367
log ratio module

TELEDYNE PHILBRICK 4130
750 ns. 8-bit A/D converter

TELEDYNE PHILBRICK 4132
3.5 μ s. 12-bit A/D converter

TELEDYNE PHILBRICK 4855
ultra-high speed sample-hold

TELEDYNE PHILBRICK 4854
sample-hold



TELEDYNE PHILBRICK COUPON

If you would like complete information on any or all of the 38 new circuit modules from Teledyne Philbrick, circle the number below. You'll get what you're asking for, fast.

1430 2301 2302 4039QZ 4060 4061 4070 4071 4072 411610
411710 4129QZ 4130 4131 4132 4133 4362 4363 4366 4367
4454 4455 4456 4457 4550 4551 4552 4706 4707 4708 4710
4711 4713 4714 4721 4854 4855 4856

Name _____ Title _____
Company _____
Address _____
City _____ State _____ Zip _____

Telephone (617) 329-1600. Or write, Dedham, Mass. 02026.
In Europe, Tel.673.99.88, Telex: 25881. Or write, 181 Chausse De La Hulpe, 1170 Brussels.
Circle 37 on reader service card

News update

Mechanical problems delay toll systems

It's going to be a while before you'll be able to pay highway and bridge tolls with a monthly check rather than each time you pass through a toll booth. The automatic vehicle-identification concept, which involves computerized sensing devices mounted on cars, trucks, and buses [Nov. 8, 1973, p. 74], is being tested at San Francisco's Golden Gate Bridge and New York's Lincoln Tunnel. And the word from the West Coast is that some problems have to be worked out before electronics takes over that function. According to Robert Thiel, a senior communications technician, the General Electric system used in a pilot test seems to be having mechanical rather than electronic glitches. It seems that engineers will have to find a way to mount the so-called designators on cars so that their circuitry won't be dislodged. This is not a problem on buses, says Thiel, because they're higher. Ten devices have been returned to GE for study, while tests continue with the bridge authority's own vehicles and some commuter buses. Meanwhile, the Port Authority of New York and New Jersey, which operates the Lincoln Tunnel, has placed a \$25,000 order with GE for devices to be mounted on various buses for tests.

D-MOS company awaits shift to high gear

Joseph Kocsis was impatient. He and his colleagues at Signetics had predicted in 1971 that nanosecond-speed MOS logic devices could be made using double-diffused MOS (D-MOS) technology. But more than three years later, the prediction still hadn't come true. So Kocsis, following that well-worn entrepreneurial trail that leads up the driveway and into the garage, left Signetics and started his own company, D-MOST Inc.—in his Saratoga, Calif., garage [Nov. 8, 1973, p. 40]. A year later, the company is still in business, though it's still parked in that garage waiting for more fortunate business conditions. Kocsis says that he'll introduce by mid-1975 a series of discrete high-frequency triodes for use with display drivers, tetraodes for communications applications, and other high-voltage discrete devices incorporating D-MOS techniques. And D-MOST continues to design custom circuits for a few customers, says Kocsis.

Signetics demodulator needs quad sound surge

The quadrasonic audio market is around two years behind schedule—behind Signetics Corp.'s schedule, that is. When the Sunnyvale, Calif., semiconductor maker developed its mono-

lithic quadrasonic demodulator circuit last year [Nov. 8, 1973, p. 25], it expected 1973 to be the year of the great quad revolution. But now, says Don Willett, consumer-product marketing manager, it appears that 1975 could be the year for the hi-fi shopper to really tune in to quad sound. Still, says Signetics, it has shipped "reasonable quantities" of its demodulator circuit to about six companies, including Victor Co. in Japan and Fisher Radio in the U.S. Signetics' Willett hopes, however, that in 1975 his company can deliver a million pieces at an average price per circuit of \$2.

Low-cost tester family growing

With an estimated 10 million of the more than 500 million digital ICs turned out this year proving to be defective, you can figure that the service cost of these faults to the industry can reach upwards of half a billion dollars. That's the market that logic testers are trying to dent, and that's why Fluke Trendar Automation Corp. of Mountain View, Calif., brought out its simplified Model 200 Testclip [Nov. 8, 1973, p. 89]. A combination logic probe, logic clip, and IC comparator, the instrument was designed and offered as a way to cut costs in the factory and in the field. Since then, two more logic testers have been added to the 200 line: the 200-02 checks high-speed TTL, and the 200-03 is designed for high-voltage C-MOS and high-threshold logic. The three systems have sold in the mid-thousands, says the company, with the original 200-01 the biggest seller. All cost \$395, and more specialized versions are scheduled to be introduced next year.

Silver-palladium alloy still being tested

Some of the silver-palladium alloy introduced as a substitute for expensive gold-filled epoxy in die-bonding hybrid circuits has been sold, says Ablestik Laboratories of Gardena, Calif., but "most of it is still under test." The reason, says a company spokesman, is that gold—and its substitute—generally goes into high-reliability systems. The alloy, which the company says reduces the migration problem associated with other silver epoxies by a factor of 10 [Nov. 8, 1973, p. 26], has replaced about 5% of gold sales, the company estimates. "It's a matter of acceptance," says a spokesman. He believes it will be another six months or so before military-qualification programs, which generally take up to a year, run their course. After that, it's a matter of getting specs rewritten.

—Howard Wolf

Intended to bring *Electronics* readers up to date on news stories of the past months.

NOTHING GETS BY THIS VERSATILE 5-MAN LINE.

O.E.M. TESTING/MEASUREMENT FOR LESS.
IMPEDANCE, RESISTANCE, CAPACITANCE AND ICs.

1234 Linear IC Tester.

A semi-automatic, linear IC tester, which measures the six most important parameters on virtually all IC op amps: Input offset voltage (E_{os}), bias current, inverting input ($I_B -$), bias current, non-inverting input ($I_B +$), DC open-loop gain, DC common-mode rejection ratio (CMRR), and oscillation detection (unity gain closed-loop stability). Non-technical operation. \$785.

1248 IC Functional Tester.

A low cost digital tester for TTL, DTL, and CMOS devices. Up to one million inspections are made in one to five seconds.

Test results are absolute; no comparison with a good IC is required. \$535.

251 Digital Impedance Meter.

Four terminal inductance, resistance, capacitance, and conductance measurements with 0.25% accuracy. Special circuitry reduces effects of lead resistance, leakage impedance, temperature, humidity, and stray field

problems. Ranges to 2 M Ω , 200 μ F, 200 H, and 2000 mS. Best available for \$1050.

275 Digital Capacitance Meter.

Most compact and easy to operate capacitance meter at its price. You get rapid capacitance (series and parallel) and dissipation measurements with a basic accuracy of \pm (0.1% + 1 digit). Ranges: C_s or C_p , 0 to 200 μ F; D, 0.000 to 1.000. Accuracy: C_s or C_p , \pm (0.1% + 1 digit); D, \pm (1% + 0.002). \$1350.

1700 Digital Ohmmeter.

The 1700 series digital ohmmeter consists of a digital converter with a 4½ digit readout and three plug-ins for range and resolution. Outstanding low ohm measurement with accuracy of \pm (0.02% + 1 digit). Two plug-ins cover ranges from 1 $\mu\Omega$ to 200 Ω . The third plug-in is autoranging from 10 $\mu\Omega$ to 20 M Ω . A companion comparator provides for production testing. Price \$1350 to \$1650.

Electro Scientific Industries
13900 N.W. Science Park Drive
Portland, Oregon 97229
Telephone: 503/646-4141



1234

1248

251

275

1700



LET'S HEAR IT FOR OL' Q.C.!

CHECK READER SERVICE NOS.

- 160 — Model 1234
- 161 — Model 1248
- 162 — Model 251
- 163 — Model 275
- 164 — Model 1700

THE FIRST OF THE BIG COUNT TIMERS

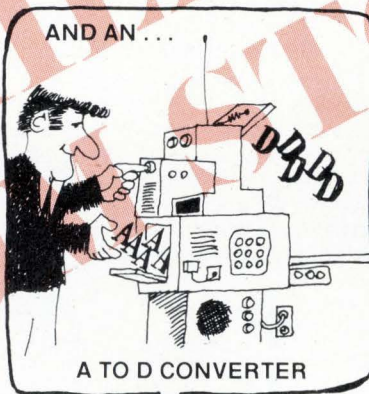
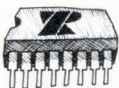
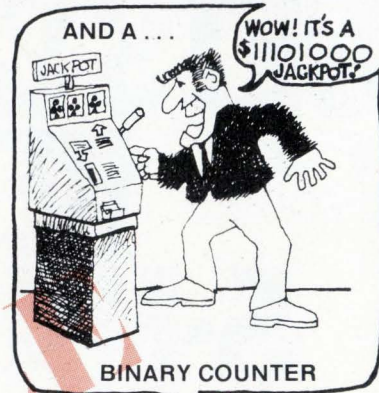
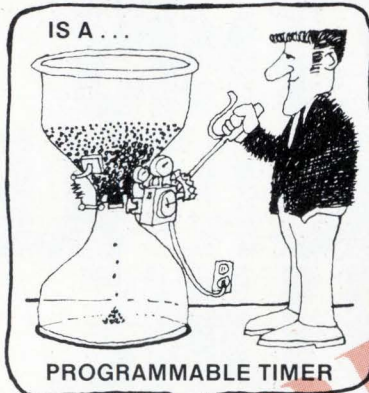
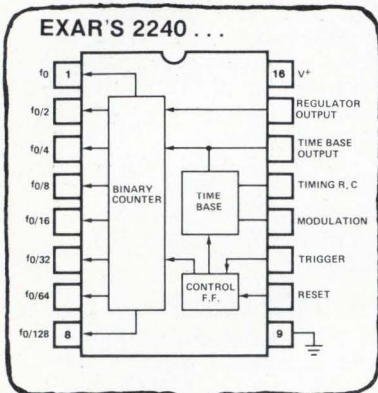

- AND AN ...
- ULTRA-LONG DELAY GENERATOR
 - DIGITAL SAMPLE AND HOLD
 - FREQUENCY SYNTHESIZER
 - PULSE COUNTER
 - BINARY PATTERN GENERATOR
 - PRECISION OSCILLATOR
- ... ALL IN ONE.

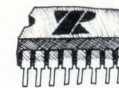
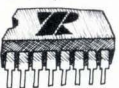

Exar's new XR-2240 counter/programmable timer solves so many tough problems that designers will unanimously agree that it's really the universal timer.

With its unique combination of analog and digital timing methods, you can now replace inadequate and complex assemblages of monolithic and electromechanical timers with the much simpler XR-2240. As a bonus, you get greater flexibility, precision operation, and a reduction in components and costs for most applications.

Because of built-in programmability, you can also use the XR-2240 for frequency synthesis, electronic music synthesis, digital sample and hold, A to D conversion, binary counting and pattern generation, and more.

With a single XR-2240 you can now generate

precision time delays programmable from 1RC to 255RC, a range of microseconds to 5 days. By cascading only two XR-2240 timers, you can extend the maximum delay by a factor of 2^N , where $N = 16$ bits, resulting in a total delay of 3 years!

The XR-2240 operates over a 4V to 15V supply range with an accuracy of 0.5% and an 80 ppm/°C temperature stability. It's available in either a 16-pin ceramic or plastic dual-in-line package for military or commercial applications. Prices start at \$4.50 in 100 piece quantities.

For the more conventional timing applications, look to our other timers: the XR-320 timing circuit and the XR-2556 dual timers. Call or write Exar, the timer leader, for complete information.

EXAR SPEAKS YOUR LANGUAGE

R-OHM CORPORATION
EXAR INTEGRATED SYSTEMS
P.O. BOX 4455, IRVINE CA 92664
TELEPHONE: (714) 546-8780
TWX: 910-595-1721

Rohm
QUALITY · RELIABILITY

R-OHM ELECTRONICS GMBH
EXAR INTEGRATED SYSTEMS
MÜHLENSTRASSE 70
4051 KORSCHENBROICH
FEDERAL REPUBLIC OF WEST GERMANY

Members of the International R-OHM Group

AT&T antitrust suit possible by spring, U.S. officials say

The Justice Department could file an antitrust suit against American Telephone & Telegraph Co. by "spring—say April or May" if it gets the go-ahead to proceed with the case, according to high Federal sources. Officially, the department says no decision has been reached. An AT&T spokesman said it would be inappropriate to comment on a report he termed "speculative." Factors affecting the Government's timing, sources say, include the **appointment of a successor to Attorney General William Saxbe**, widely expected to be replaced sometime early next year. **Also needed is a determination by the department on exactly how it will ask the courts to break up AT&T if it proceeds.** Options said to be under consideration include: a spinoff of Western Electric Co., AT&T's manufacturing arm; making AT&T Long Lines a separate company that would service Bell System operating companies; making the operating companies independent, or a combination of all three. Among the other unresolved issues: how to provide for funding of Bell Laboratories, now supported in large part by Western Electric.

FAA to request proposals for DABS next month . . .

A request for proposals for the Discrete Address Beacon System (DABS) may go out by Dec. 1 if the Federal Aviation Administration resolves an internal controversy over whether the contractor-to-be should subcontract the airborne part of the package—the transponder and cockpit display—to "an established avionics manufacturer," say FAA sources. Ground stations are the other part of DABS, which provides air-traffic controllers with digital and hence interference-free identification and tracking of aircraft [*Electronics*, April 4, p. 88]. **A major addition to the request for proposals, which has been delayed since July, is a brassboard ground-based collision-avoidance system** to be wired into DABS.

Cause of last summer's delay was a "major functional review of the entire DABS program," says the FAA. As a result, procurement of prototype equipment has been pushed back to March 1977. The FAA estimates that **more than \$200 million will be spent on development and acquisition of ground systems for up to 400 sites.** Industry sources estimate up to \$250 million may be spent on 100,000 transponders.

. . . as budget cuts threaten other FAA projects

FAA procurement may have less money behind it in the next two fiscal years. The FAA confirms that **a project for an improved airport-surface-detection-equipment (ASDE) radar has fallen victim to the budget ax.** An earlier attempt to develop a next-generation ASDE also was scrubbed after requests for proposals had been issued and bids received [*Electronics*, Aug. 2, 1973, p. 51]. Development of microwave landing system prototypes also may have to be cut back (see p. 51).

U.S. aerospace jobs seen stable through June

Engineering and scientific jobs in the U.S. aerospace industry are expected to remain relatively stable through the first half of 1975, slipping fractionally from a December level of 165,000 to 163,000 by next June, forecasts the Aerospace Industries Association of America. Similarly, AIAA's survey of 50 member companies shows jobs for technicians holding at 67,000. Total aerospace jobs, however, are expected to **drop by 8,000 to 959,000 in June,** as commercial transport deliveries slow.

How inertia skews EIA's forecast

About a decade ago, when the late Walter Finke was running Honeywell's aggressive computer business, he pleasantly surprised a reporter by telling exactly how he expected Honeywell and the rest of the U.S. data-processing industry to perform in the following three to five years. The dollar volumes forecast were impressive. Yet Mr. Finke remained smiling but silent when pressed to speak about the next 12 months. His explanation: "Ask anything you want about what I think of the market five years from now. My guess is as good as anybody else's, and, if I am wrong, no one is going to remember it when the time comes anyway. But please don't expect me to be foolish enough to be specific about next year. Those are the forecasts that can come back to haunt you."

The wisdom is worth recollecting when reading the Electronic Industries Association's new five-year forecast for the U.S. Government electronics market. Cliff Bean of Arthur D. Little, chairman of EIA's studies and forecast subcommittee for the Government Products division, led the presentation to members at the association's annual convention in California at the end of October. Based on inputs from as many as 22 member companies, EIA's analysts predict that the Federal market will climb nearly 45% to \$22.85 billion by 1980 from a 1975 level of \$15.8 billion. It appears at first reading to be a reasonable estimate, as good as any available in Washington.

Troubling components

The trouble comes when the study starts to break out the components of those markets and in its economic assumptions for the short term. EIA's calculations may not be far wrong when they peg 1980 military electronics outlays at \$16.75 billion, up one third from what they see as a 1975 market of \$12.72 billion. But most of that dollar increase will be eaten up by inflation, EIA believes.

A bigger problem for EIA comes when it guesstimates that the U.S. electronics markets for nonmilitary agencies will climb by an astonishing 88% over the next five years. Its run-down of 13 civilian agencies has their combined spending at \$6.1 billion in 1980 compared to \$3.25 billion in 1975. What is startling about those statistics are the components that forecast the Environmental Protection Administration's generating some \$2.7 billion in electronics business in five years, a factor of four increase. Similarly, the huge Department of Health, Educa-

tion, and Welfare—second only to DOD in spending—is predicted to increase its outlays for electronics by 41% in the same time frame for a 1980 total of \$1.4 billion. Commerce Department outlays are seen as doubling to \$101 million, while the Urban Mass Transportation Administration is expected to triple its electronics budget to \$100 million by 1980, despite a distinct coolness in both the White House and the Congress to major new mass transit undertakings.

What skews these civil agency numbers is the absence of any hard Government data for EIA to work with and the paucity of inputs received by the association from members who have limited interest in and contact with the agencies involved. Consider the example of UMTA. Last year the range of EIA's inputs on that agency's total 1975 budget spread from \$500 million to \$1 billion, producing an average of \$645 million. Estimates of UMTA's electronics programs for the same fiscal year varied between \$15 million and \$54 million and averaged out to \$36 million. Such numbers are virtually worthless.

Static assumptions

Another distortion in the estimates seems apparent in the forecast's assumptions on the domestic economy over the five-year period. They include an inflation factor of no more than 6.5%, a national economic growth rate of 10%, and a Federal budget that will remain at 20% of the Gross National Product. Alan Greenspan, chief economic adviser to President Ford, would no doubt be delighted if those levels can be attained. Latest third-quarter figures put inflation at 11.9% and rising, while the real GNP declined in the July-September period by 2.9%. Greenspan has said he is hopeful that inflation will flatten out by next spring; he is less certain when it will turn down.

Consider, too, that when EIA delivered its forecast of a year ago, it predicated its estimates on an annual inflation of 3-4%. Real inflation at that time was running at 7%. It was then that Austin Hoggatt, an economist and professor at the University of California at Berkeley, needled EIA by observing that its forecasting "had a very high inertia." That observation is still pertinent today. Five years from now, no one is likely to recall, much less care, how close or far from the mark EIA was. That's the Finke rule. But a year from now, the association may find that the inertia that burdens its estimates has produced a ghost that won't go away.

—Ray Connolly

Data Precision Introduces A New 4-1/2 Digit DMM

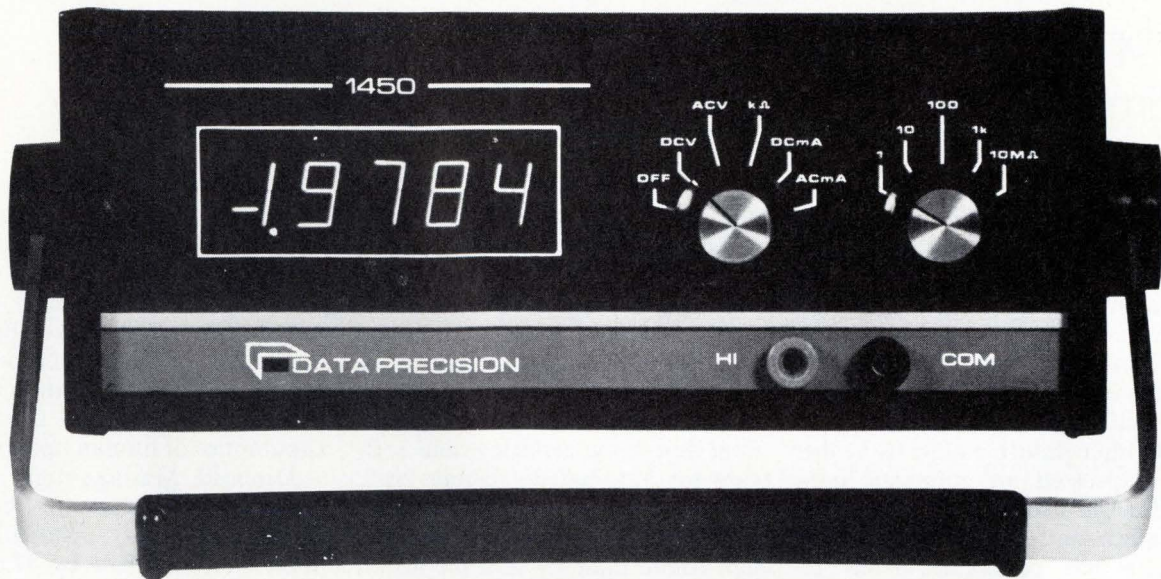

MODEL 1450

only **\$325.** complete

BIG, BRIGHT 1/2 INCH PLANAR DISPLAY
5 FUNCTIONS - 21 RANGES - 100% OVERRANGE
6 MONTH DC ACCURACY OF $\pm 0.02\%$
OF READING, $\pm 0.01\%$ f.s.

Data Precision's newest family member is a 5-function, 21-range, economical, laboratory-precision bench instrument. This low cost/high performance 4-1/2 digit Multimeter features bright 1/2 inch planar display, full electronic overload protection to 1000V on all DC ranges, 500V on AC, 115V on resistance, fuse protection on current. Simple 2-knob operation. Data Precision proven circuitry includes Tri-Phasic™ auto-zeroing A/D converter, Ratiohm™ resistance mea-

surement and the patented high-stability Isopolar™ reference. One year warranty, Certificate of Conformance, Test Documentation, instruction manual and probes.

- DC Volts, 100 microvolts to 1000V
- AC Volts, 100 microvolts to 500V RMS
- Resistance, 100 milliohms to 20 Megohms
- AC and DC Current, 1 microamp to 2 Amps
- AC Voltage/Current response, 30Hz to 50kHz

In-stock availability from our representatives:

AL (205) 533-5896	GA (404) 457-7117	MN (612) 781-1611	NY (N) (315) 446-0220	UT (801) 268-3181
AZ (602) 994-9519	HI (808) 262-6286	MO (W) (816) 737-0066	NY (S) (516) 482-3500	WA (206) 763-2210
CA (N) (408) 733-9000	IL (312) 593-0282	MO (E) (314) 731-2331	OH (N) (216) 725-4560	
CA (S) (714) 540-7160	IN (317) 293-9827	NC (919) 787-5818	OH (S) (513) 885-4171	
CO (303) 449-5294	MA (617) 273-0198	NJ (S) (215) 925-8711	OR (503) 238-0001	CAN (W) (416) 787-1208
CT (203) 525-7647	MD (301) 792-8661	NJ (N) (201) 863-5660	TX (N) (214) 234-4137	CAN (W) (613) 772-5874
FL (813) 294-5815	MI (313) 482-1229	NM (505) 265-6471	TX (S) (713) 461-4487	CAN (E) (514) 731-9328

DATA PRECISION
 ...years ahead

Data Precision Corporation
 Audubon Road, Wakefield, MA 01880
 Phone (617) 246-1600

European show reflects optimism for automation

An upbeat mood permeated the International Instrumentation and Automation Exhibition (Interkama) in Düsseldorf this month. "Our market still looks OK," was the sanguine assessment of Erwin Ohlig, head of the Measuring and Process Control section in West Germany's Electrical Industry Association. Many other industry officials at the show expressed an optimistic outlook for the market in process-control equipment.

About 850 companies from 22 countries displayed the latest in control engineering and instrumentation in a display area of nearly half a million square feet. There were 80,000 visitors.

The space occupied by U.S. firms was relatively small—0.6% of the total. But Interkama officials pointed out that U.S. wares were prominent at the stands of American subsidiaries and foreign companies selling U.S.-developed products or making them under license.

Prominent at the displays of many European firms were new process computers, some of them built with the latest in circuit technology. The trends toward micro-processors in process computers was very much in evidence. Modular designs and user-oriented software are also coming to the fore. There's a definite trend toward satellite computers, explains Rolf Schuh, a Siemens official. Also, a combination of direct-computer control and set-point control is being used more and more for optimizing processes.

Automation. Despite cuts in capital investments, it was revealed at Interkama that spending for automation continues to rise. This provides near-boom conditions for control-equipment sales in the otherwise gloomy industrial climate that prevails in much of Western Europe. As for West Germany, Fritz L. Reuther, a member of the Inter-

kama presidential committee, predicts this year's spending for automation to reach \$5 billion, an 8% increase over the total for 1971. Some observers put this year's figure for automation spending by the nine Common Market countries at \$20 billion to \$25 billion.

This includes outlays for planning, designing, servicing, and software for automated facilities. Still, the hardware share for electronic/electrical equipment is quite high—more than 5% in some installations, estimates Schuh, of Siemens. The share for process computers alone is often more than 10%.

The growth rate for automation has tapered off considerably from that of the mid-1960s, when in West Germany, for example, outlays leaped from \$1.5 billion in 1965 to \$3.8 billion in 1968. But prospects still look bright. The spurt during the 1960s came from massive efforts to raise productivity, but new impulses during the 1970s and beyond are expected to come from the worldwide energy shortage, from attempts to solve environmental problems, and from the search for more raw materials. "All this," Reuther says, "requires new technologies in which instrumentation and automatic systems will rate prominently."

Energy. For example, the need for more nuclear power plants to replace fossil-fuel sources spell more automatic control and safety installations. Likewise, geothermal energy and solar radiation—sources still to be tapped on a large scale—open up further prospects for the industry.

Automation is also expected to get a big push from projects aimed at reusing raw materials, and Reuther points to a waste-recycling program the Bonn government is now considering. Still another future area for automated techniques is forecast in tapping energy and raw

material sources where conventional processes are still uneconomical.

Besides these future tasks, one of the major near-term aims of automation is to guarantee product quality and to improve the reproducibility of manufacturing processes in which the complexity and speeds are far beyond the reaction capabilities of human operators.

Diebold Management Consultants estimates that the number of process-computer installations in West Germany rose by 47.6% from July 1973 to July of this year. During the same period, the increase of universal computers was 15.4%. By 1978, observers predict, a total of 15,000 process-control machines will be installed in West Germany—double the current numbers. Although the figures differ, the situation is much the same elsewhere in Europe, officials reported. □

Great Britain

Agency aims CCDs at radar functions

The Royal Radar Establishment is seeking to capitalize on the economical processing of complex signals offered by charge-coupled devices (CCDs). The RRE has built a prototype integrator, and three of its scientists presented papers on the subject at the recent International Charge-coupled Devices Conference in Edinburgh, Scotland.

The papers covered developments in transversal filtering, filtering in moving-target indicators (MTIs), and video integration with CCD delay lines. However, implementation is not imminent, says P. J. Bulman, superintendent of the Semiconductor Technology division. He adds that the establishment intends to de-

velop "those and better devices into demonstration systems."

Filtering in moving-target indicators is likely to be the first radar application for CCD delay lines, predicts Roy Eames, one of the RRE scientists. An MTI filter discriminates between returns from stationary objects and moving ones by comparing the frequency of the returned radar signal with the one transmitted so that the beating between the two shows up as an amplitude fluctuation at the doppler frequency.

Recirculation. CCD analog shift registers promise to enhance the signal-to-noise ratio of repetitive signals by integrating them with a recirculating delay line, says Brian Roberts, another scientist. CCD-based video integrators may become useful in improving radar displays and reducing noise in television pictures, with the bonus of easily compressing bandwidths. CCD delay lines could make possible transmission of radar data and TV signals through narrowband channels.

The prototype integrator is built around a delay element of a p-channel silicon, three-phase, CCD device that stores 64 samples. However, some defects must be overcome. One believed to be easily surmountable is the inefficient charge transfer in present devices, which can limit the number of recirculations.

However, Roberts points out that the analog CCD systems are much cheaper than digital processors, especially for signal bandwidths in the megahertz range.

The use of CCDs for transversal filtering is important because "you can realize the functions without a recirculator," which is needed in present systems, Bulman points out. A transversal filter is a filter having frequency-transmission properties that exhibit a periodic symmetry.

In this instance, it is a delay line tapped at various points to produce signals that are the weighted sum of stored samples. The CCD's capability of being nondestructively tapped "opens up a whole demultiplexing capability," Bulman says.

In his paper, Donald J. MacLennan, a doctoral candidate at the

Around the world

Sub-hunting sonar is helicopter-borne

Exports are scheduled to begin next year for the DUAV-4 sonar, which is to become standard on all export versions of the Franco-British Lynx light-weight helicopter, due in service with the French navy in 1976. The modular DUAV-4, built by CIT-Alcatel, weighs only 543 pounds, compared with well over 650 pounds for most rival hardware. The sonar, with twin alternating beams, is claimed to end echo interference from the seabed. The DUAV-4 is light enough to be carried on small helicopters like the Lynx, a 9,000-pound aircraft that can be based in pairs on small surface vessels of about 2,500 tons.

Process speeds up chip isolation

The Musashino Electrical Communication Laboratory of the Nippon Telegraph and Telephone Public Corp. has developed a new method to achieve dielectric isolation, called iPOS for isolation by porous oxidized silicon. Silicon is converted by an electrochemical process into a porous material in regions that will form vertical-isolation zones. The researchers claim that they can oxidize reactive porous silicon to a depth of 5 micrometers in 10 minutes in steam at a temperature of 1,150°C, compared to 35 hours needed to oxidize bulk silicon to the same depth at that temperature. Among the experimental devices made by this method are an IC with two stages of nonthreshold low-level logic, each with emitter-follower output.

3-chip calculator monitors gas pumps

Siemens AG has introduced a three-chip MOS calculator that can replace the conventional counting mechanisms used in most gasoline pumps. The system has a big price advantage over labor-intensive mechanical counters, it does not wear, it requires no maintenance, and it lends itself to data transmission in self-service stations. As many as 10 pumps are scanned by central monitoring and invoicing equipment in the attendant's office. The pumps transmit the amount of pumped gas, as well as price information for billing.

University of Edinburgh who has worked at the RRE, described a technique of using biased gates to non-destructively tap the analog signal as it is passed along from one cell to the next in the shift register.

By means of this technique, MacLennan said he has been able to remove the noise from the signals and time-sample the analog waveforms of both an eight-chip uniform pulse train and a 13-chip Barker-coded pn sequence. (The Barker code is a form of pulse compression.) He stated that tapping with shift registers in parallel uses the entire bandwidth, which promises to triple the data rate now achievable with a three-phase device. What's more, it may eliminate sample-and-hold circuitry in some applications.

The other technique also offers the possibility of programing the filter-impulse response, which would

allow fabrication of programable transversal filters and related CCDs.

Tapping. The tapping technique requires that one set of clocking electrodes be charged to a dc potential. When the charge is clocked under the electrode, the electrode potential changes and remains at the new value until the charge is removed. The changes in potential may be sensed by an MOS transistor operating as a small signal amplifier, MacLennan notes.

Eames, who has experimented with both CCDs and bucket-brigade devices (BBDs), says that both seem ideal for MTI signal processing because of their capabilities: a maximum of about 100-millisecond storage and delay times, greater than 40-db dynamic range, storage capacity of about 100 samples, clock rates as high as 10 MHz, and simple serial access to data. □



Just arrived! Our 12-bit CMOS DAC.

Our new baby's a beauty. With 12-bit resolution and *guaranteed* linearity of $\pm\frac{1}{2}$ LSB in 10 bits over -55° to $+125^{\circ}\text{C}$.

We've christened it Model 872, and it's a *complete* DAC. CMOS input logic, R-2R ladder, micropower output amp, internal reference—even preset zero offset and gain—are all inside.

And all of this comes in one neat package just 1" by 1.5". Price is \$49.50 to \$66 in 200-piece quantity, depending on linearity and internal reference specs.

You might have expected it, considering that we're one of the country's major suppliers of DACs...and among the leading hybrid manufacturers, too. We make a lot of standard hybrids, but we're also great problem-solvers in custom situations.

If you need immediate technical literature or the telephone number of your local Beckman/Helipot representative, call toll-free (800) 437-4677.

Beckman®
HELIPOT DIVISION

Cash gains boost commerce between Soviets and West

Trade between the West and the Soviet Union is showing signs of a sharp upward swing as a result of increases in prices the Russians are getting for their raw materials on world markets. This, say West German sources, is giving the country more hard currency to finance industrial projects and **to buy much-needed Western goods, especially machine tools, computer equipment, and process-control gear.**

Although now richer in Western cash, says a marketing official at AEG-Telefunken, the Russians are still "tough negotiators, and the process of reaching an agreement with them can be time-consuming."

Trade flow between the Soviet Union and West Germany is expected to reach \$2.7 billion by the end of this year, a record level by East-West standards. West Germany, relatively poor in raw materials, is a large customer for Soviet oil, phosphates, copper, gold, and lumber. Prices for some of these resources have recently increased by as much as 100%. "The Russians are now also more inclined to conclude business deals on a cash-payment basis," says the AEG-Telefunken man. He cites a deal whereby the company's subsidiary, Olympia Werke AG, will put up a \$50 million electric-typewriter factory at Kirovograd in the Ukraine. **The plant is to produce 150,000 typewriters a year.**

Fiber-optic cable transmits signals for short distances

While many researchers are developing fiber optics for long-distance communications, the Pilkington Brothers Optical division has been developing short cables. In early November at Electro-Optics 74 in San Francisco, Pilkington will introduce the Hytran 100, a commercial moderate-loss fiber-optic cable designed to replace high-quality shielded copper cable for short-range transmissions. **The Pilkington cable is said to cost one tenth as much as low-loss fibers.** The UK company claims that the multimode optical-glass fiber is suited for cables as long as 175 meters. **It provides a wide entry angle of 60°, and attenuation for light-emitting-diode signals is no greater than 100 decibels per kilometer at a signal wavelength of 850 nanometers.**

The modulation frequency range is expected to extend to 20 megahertz. The company says that fiber optics won't be widely used for 10 years in long-distance telecommunications, but demand for short-range cables is increasing.

German buses get power from storage batteries

A bus line using battery-powered vehicles has been started in the North German town of Mönchengladbach, near Düsseldorf. **The electronically controlled electric drive motors, from Robert Bosch GmbH, are said to have a continuous output of 90 kilowatts and a limited-duration output of 180 kW at maximum efficiency of 92%.** The efficiency of the electronic control system, Bosch says, is 99%. By reconverting energy while braking, the bus's operating range is extended by 30%.

UK competitor joins market for automated painters

The growing market in automated painting machines for production finishing lines is becoming a free-for-all, now that a new machine is about to be distributed in the UK by Binks-Bullows Ltd. and in the U.S. by Binks Manufacturing Corp., Chicago. The painter competes with the Tralfa from Norway and Versatran from the U.S. Designed by

International newsletter

Douglas Hall of Hall Automation Ltd., the machine's 17 printed-circuit boards loaded with electronics convert a tape cassette's digital instructions to analog commands for servo systems. **Priced at about \$30,000, the Ramp 4088 stands six feet tall "and has a pretty fair reach," Hall says.** The machine is programmed by manually leading it through the desired operation as the motions are recorded on the tape. Hall designed the machine when he was with Pye Ltd.

Texas Instruments joins ITT in UK distribution deal

In a deal that company executives strongly hint could spread extensively, the ITT Components group has enfranchised TI Supply, a subsidiary of Texas Instruments, to be a distributor of ITT's passive components within the United Kingdom. Although both companies say that the agreement strengthens their respective operations, **it raises intriguing questions about possible future arrangements elsewhere.** One of ITT's two distribution operations, Blueline Electronics Service, already handles TI semiconductors as its main line. **Involved in the new latchup are capacitors, power supplies, switches, diaphragm relays, and thyristor firing-pulse transformers.**

Addenda

Sony Corp., Tokyo, has joined with Union Carbide Corp., New York, to form in Japan an equally owned company, Sony Eveready Inc. The deal is subject to Japanese government approval. Akio Morita, Sony president, says **the new company will market a range of high-performance dry-cell batteries and battery-related products in Japan.** Sony Eveready will consider production of dry-cell batteries in the future, Mr. Morita added. . . . **The battle between the UK's General Electric Co. and Brown, Boveri & Cie of Switzerland to buy a minority share of George Kent appears to have been decided in favor of Brown.** The government action came after Brown offered to inject about \$15 million into Kent and a poll showed that 75% of Kent's 7,300 workers favored Brown's bid over GEC's, although employees at Kent's Cambridge Scientific Instruments endorsed GEC. The British government owns 24% of Kent, and the Rank Organization holds 18%. . . . BASF is beginning to market quadrasonic-sound cassettes. **The German firm will begin with five music programs—one classical and four "pops"—each of which will cost "no more than an ordinary LP record."** The playback time per tape side is 18 to 20 minutes. The quadrasonic sound is encoded on each tape's two stereo tracks. In playback, circuitry decodes the signals in these tracks for the four quadrasonic channels. . . . **An electronic hole-in-one game is being opened at Lavender Park driving range in Ascot, England.** Called Jackpot, the system automatically dispenses coded balls for each driving bay and will pinpoint on a central console the bay, lane, and hole where a duffer gets a lucky shot. . . . The British Post Office plans to expand the London Airport Cargo Electronic-Data Processing Scheme (Laces), which it manages. **From controlling only imports at Heathrow now, the BPO plans by April 1976 to include exports and expand to other UK airports as well.** . . . On the heels of its big order for telephone-switching equipment from Syria, CIT-Alcatel of France is about to score again. **CIT heads a consortium that is expected to receive a \$19 million order for telecommunications-transmission equipment from neighboring Iraq at the end of this month.**

Centralab perspectives

FOR USERS OF ELECTRONIC COMPONENTS

DISTRIBUTOR PRODUCTS

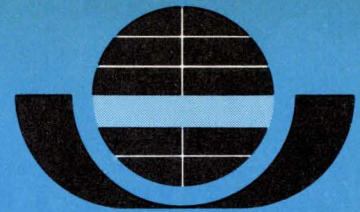

CENTRALAB

Electronics Division
GLOBE-UNION INC.

5757 NORTH GREEN BAY AVENUE
MILWAUKEE, WISCONSIN 53201

To get the latest generation component, engineers are saying Selectashaft®—before they say rotary switch.

Distributor assembly of this mechanically superior rotary switch gives them instant delivery on over 100,000 custom assemblies and eliminates secondary modification costs.

If you're specifying or buying rotary switches, your Centralab Selectashaft Distributor would like to let you compare this totally new switch with any old style switch. One sample is all you'll need to see how it can meet custom specifications yet save from 3% to 17% on total cost, depending on switch type and quantity.

Selectashaft is the first name for rotary switch. Electrically equivalent to our famous PA-Series switches, it's the latest generation component. Mechanically superior to any old style rotary, it gives you adjustable torque, better feel and longer life. It uses a new dual ball, side-thrust index, and incorporates an adjustable stop ring instead of the old style stop tabs. There are no modification problems — no bare metal to rust or corrode, no scrap, no loss of warranty and no secondary modification cost. You get everything you need — exact shaft length, end detail and shaft flat angle without modification. And, when you consider the cost savings, the reasons to say Selectashaft — before you say rotary switch — are clear. Ask for a sample and see.

Circle 49 on reader service card



THIS CATALOG, available from your Distributor, gives complete specs, dimensional drawings, circuit diagrams and easy ordering instructions. Ask for it. You'll find the answers to your design and delivery problems.

THE SELECTASHAFT SYSTEM consists of preassembled standard rotary switches and a series of individual exact shafts. Factory trained Distributors, using specially designed equipment, assemble these parts to meet custom requirements. You choose from three shaft styles — .250" plain round, .218" and .156" flat. There are 24 shaft lengths, .687" to 2.375" and 24 shaft flat angles in 15° increments. You select from 92 subminiature and miniature switches — 1", 1.325" and 1.500" diameters; diallyl phthalate, phenolic or ceramic sections. You have your choice of knobs, dial plates, index assemblies and hardware. You get the design freedom of over 100,000 possible custom switch combinations.

ASK FOR SELECTASHAFT ROTARY SWITCHES AT THESE CENTRALAB DISTRIBUTORS:

CALIFORNIA

Abacus Electronics
Mountain View 94040
415/961-1500

Elmar Electronics Inc.
Mountain View 94041
415/961-3611

Kierulff Electronics Inc.
Los Angeles 90022
213/685-5511

COLORADO

Acacia Sales, Inc.
Lakewood 80215
303/232-2882

FLORIDA

Electronic Equipment Co.
Miami 33142
305/871-3500

Hammond Electronics
Orlando 32802
305/241-6601

INDIANA

Radio Distributing Co., Inc.
South Bend 46624
219/287-2911

Ra-Dis-Co. Inc.
Indianapolis 46202
317/637-5571

KANSAS

Radio Supply Co., Inc.
Wichita 67211
316/267-5214

MASSACHUSETTS

Wilshire Electronics/N.E.
Cambridge 02138
617/491-3300

MICHIGAN

RS Electronics
Detroit 48227
313/491-1012

MINNESOTA

Gopher Electronics Co.
St. Paul 55113
612/645-0241

NEW YORK

Peerless Radio Corp.
Lynbrook, L.I. 11563
516/593-2121

Summit Distributors
Buffalo 14202
716/884-3450

NORTH CAROLINA

Kirkman Electronics
Winston-Salem 27108
919/724-0541

OHIO

Esco, Incorporated
Dayton 45403
513/226-1133

Pioneer-Standard Electronics
Cleveland 44105
216/587-3600

Stotts-Friedman Company
Dayton 45402
513/224-1111

PENNSYLVANIA

Cameradio Electronics
Pittsburgh 15222
412/288-2600

Herbach & Rademan, Inc.
Philadelphia 19134
215/426-1700

Philadelphia Electronics Inc.
Philadelphia 19107
215/568-7444

TEXAS

Harrison Equipment Inc.
Houston 77004
713/224-9131

Texas Instruments Supply
Dallas 75235
214/238-6811

Southwest Electronics Inc.
Stafford 77477
713/494-6021

WASHINGTON

Almac/Stroom Electronics
Seattle 98108
206/763-2300

By the time your drum plotter turns this out, a Gould printer/plotter can turn it out 400 times.

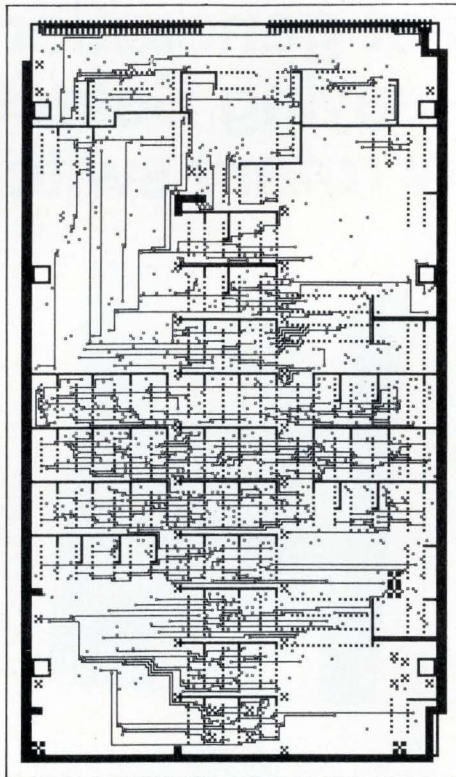

If what you're looking for is higher plotting speed and lower plotting cost, we've got something that can give you both. And something else besides.

A Gould electrostatic printer/plotter. The one that makes your old drum plotter remarkably unproductive. The one that gives you a useful printing capability in the bargain. A Gould plotter is so fast, it can turn out this plot in only 2 seconds — versus an average 13½ minutes for your old drum plotter.

And what gives that Gould plotter its blinding speed is its direct on-line operation to your computer. PDP-8/E, PDP-9, PDP-11, PDP-15, HP2100, Nova/Super-nova, H316/516, Raytheon 704, UNIVAC 1108, IBM 360/370, CDC 3000/6000, SEL 810, Interdata 70 and more.

In addition to output speeds up to 400 times faster, a Gould printer/plotter gives you a lower unit cost, as well as lower paper cost. Better-looking output, since there's no ink to smudge, clog or run out of. Few moving parts for quiet operation, high reliability. Software

that's upward compatible with the leading drum plotter. Without any sacrifice in mainframe CPU time.

And, in addition to everything else, it gives you an alphanumeric printing capability that also lets you compile management reports at speeds up to 3000 lines per minute.

Users will tell you that a Gould electrostatic printer/plotter makes their computer-aided design system truly interactive since output of modified data for verification can be quickly obtained. And by producing hardcopy output in a matter of seconds — instead of the many minutes it can take with older methods — time savings are maximized.

This all adds up to the best printing/plotting hardware and software available anywhere. And it's backed by Gould's own factory-trained service technicians.

To learn more about Gould electrostatic printer/plotters — get in touch with Gould Inc., Instrument Systems Division, 20 Ossipee Road, Newton, Mass. 02164 U.S.A., or Kouterveldstraat 13, B 1920, Diegem, Belgium.

 **GOULD**

Probing the news

Analysis of technology and business developments

MLS decision time nears

\$1.5 billion market beckons as advisory committee races Dec. 20 deadline on which Microwave Landing System technique to use

by Larry Marion, Washington bureau

Siebert (Sig) Poritzky bears only a slight resemblance to Santa Claus, but he and his Microwave Landing System Advisory Committee have been told to deliver a potential \$1.5 billion Christmas present to two of four competing avionics system makers. The present: a recommendation on which technique—conventional scanning beam or doppler scan—to adopt for the long-planned replacement for Instrument Landing Systems, the Microwave Landing System.

But for Poritzky, an electrical engineer employed by the Air Transport Association who also was chairman of the international group that determined the original MLS specs in 1967, the problem is timing. He and his fellows have been given until Dec. 20 by the Federal Aviation Administration to provide answers to a question that's been hanging for seven years—whether scanning beam or doppler is better. Actually, that Dec. 20 recommendation is the prelude to a January FAA decision on \$20 million in prototype development funds, and the stake is a head start toward eventual selection by the International Civil Aviation Organization and resulting worldwide MLS sales (see panel, "Who's doing what," p. 52).

Poritzky's problem had been compounded by FAA studies that failed to reach strong conclusions. But at a briefing earlier this month (two more are scheduled), advisory committee members said things seem to have changed. They told the FAA's project manager, Joseph DelBalzo, that they are encouraged by recent FAA studies that have pinpointed advantages of certain tech-

niques. DelBalzo in turn said that at his next briefing, in November, eight "key technique-selection issues" will be selected from the more than 100 brought up at his first session.

Still, advisory committee members are not optimistic that working groups and assessment teams can meet the FAA's deadline for submitting its recommendation to a blue-ribbon executive committee representing government agencies—the FAA itself, the Department of Transportation, the Defense Department, and the National Aeronautics and Space Administration.

The advisory committee is made up of four members from the military, four to six representing users, three from outside consultants, two from manufacturers, and one from NASA. Says one member, Michael Huck of the Aircraft Owners and Pilots Association, "We're spread aw-

fully thin. We have been working on this almost daily since August."

"Some reviews have bogged down," says Seymour Everett, FAA performance-review team chief. A "lack of [FAA] ground rules," says a Bendix Corp. representative, has resulted in incompatible performance data for comparing breadboard system performances. "Contractors took more liberties with the data than we expected. It surprised us," Everett commented.

Software. FAA consultant Vitro Laboratories, Silver Spring, Md., has been slowed in its development of software to delete monitoring-equipment signal interference from MLS-system signals, he says, but he expects FAA and Vitro data review to be finished in time for an early November meeting of the performance subgroup.

Committee member Arthur A. Dorne, an aviation consultant, told

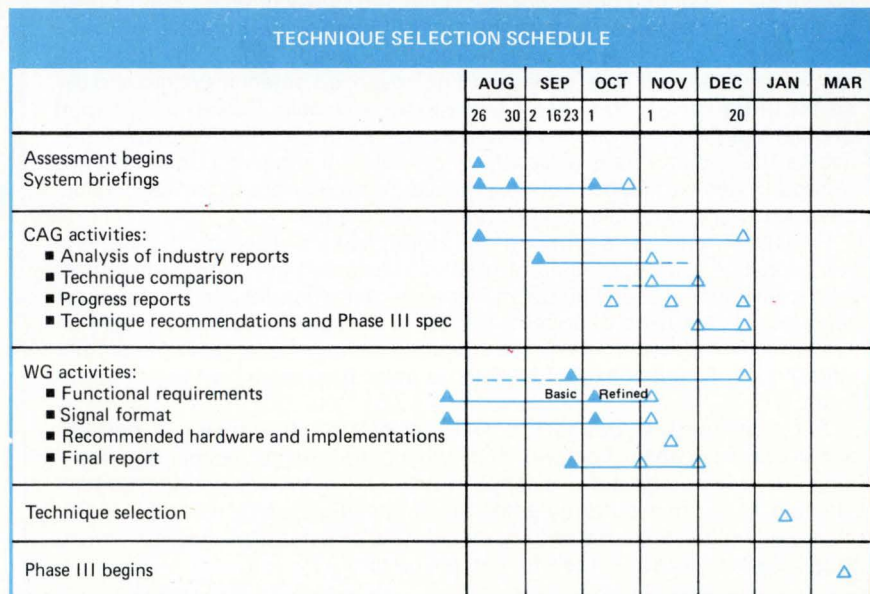

Probing the news

committee members that he had serious doubts that these and other preliminary studies could be finished before the next MLS advisory committee meeting. Everett and his colleagues were reluctant to discuss what they saw as contractor shortcomings, but the following problems were among those revealed in the eight-hour session:

- "Massaged data" from the four breadboard MLS contractors "surprised" advisory committee members and Everett, but Everett assured them that the massaging resulted from hardware problems unrelated to technique. Texas Instruments' back-to-back azimuth antennas developed noise-interference problems, he said, and TI confirmed the situation. "Due to a physical misalignment of the antennas" during tests this summer at Wallops Island, Va., "a 2.5-hertz noise component" created a "residual error trace" in TI's signal data, but Everett says FAA staffers can straighten it out before the early-November review sessions.
- ITT Gilfillan "censored its data" by removing certain effects, noted

Everett. Out-of-spec signals were deleted because of "hardware effects," he says, adding that the censoring was not significant. ITT Gilfillan deleted some data points on performance graphs measuring MLS-system accuracy against tracking-system accuracy if the points were outside of preset limits. ITT Gilfillan's Walter Fairbanks said companies "interpreted things differently" because they were told to follow international specs, which are not explicit enough.

- Bendix Corp.'s data was skewed a little more than others, reported industry sources, because it chose wider performance limits than the other companies. A Bendix official says an inadequate aperture on its ground antenna's lens impaired equipment performance, so data was changed to reflect an adequate ground signal.

- Preliminary cost estimates provided by contractors were impossible to compare because of differences in contractors' definitions, FAA cost-assessment chief Jack Edwards told committee members. He refused to explain which contractor represents the base cost or the dollar range for other cost estimates, but data displayed at the briefing re-

vealed variations of up to 2,300% in cost estimates for training and installation. There was, for example, a 380% variation between two teams in the cost of a ground-distance-measuring-equipment transmitter.

"Everything works. Despite the difficulties in reviewing performance data, industry officials were able to make some initial judgments on the merits of competing systems. "Everything works," commented TI's project manager, R.M. Lockerd, echoing the majority viewpoint. While reviewing his company's performance, he said that if TI wins a prototype contract, it will use an electronic phased-array antenna similar to that of the Bendix Corp. instead of a mechanical antenna. Bendix, heading a scanning-beam team, insists that the doppler concept would not work because of more complex electronics requirements for filtering multipath (interference) signals. But industry consultants continue to say that doppler, espoused by the Hazeltine Corp. and ITT teams, is the leading contender [*Electronics*, Oct. 17, p. 49].

More than \$1.5 billion in equipment sales is the prize, say FAA staffers and contractors. They break it down this way: \$500 million for airborne avionics, basically receivers to decode ground signals that inform the pilot of runway distance, angle of approach, and rate of descent, and \$1 billion for ground equipment for the major airports in the world. This includes hundreds of airports in Western countries alone, although estimates of the size of the market await another FAA uncompleted study.

Because of the worldwide implications, many sources say it is a foregone conclusion that doppler will prevail. Great Britain has already selected doppler and funded development by Plessey Radar Ltd. Because of Britain's radar prestige in the ICAO, American observers say the numerous small countries will back Britain if the U.S. decides to promote conventional scanning-beam equipment. "It is essentially a not-invented-here political problem" that has the British favoring doppler, says Bendix's engineering director, Joseph McCormack. □

Who's doing what

Bendix Corp., in partnership with Textron's Bell Aerospace division and Lockheed Georgia Co., received \$3.2 million for breadboard versions of its conventional scanning beam MLS, but Bendix director of engineering Joseph L. McCormack notes that "all the companies [involved in MLS breadboard systems] have sunk a fortune into development." Bendix used an electronic phased-array antenna for its C-band signal output.

Hazeltine Corp., together with Marconi of Canada Ltd., is the front-runner, some observers feel, because of its advanced antenna system and decision to transmit both C-band and Ku-band signals. Called a beam-port doppler antenna, it produces elevation signals in a controlled pattern that avoids the ground, says a Hazeltine official. Consequently, the Hazeltine ground system would be more expensive, but the airborne package a little cheaper than less sophisticated commutated doppler.

ITT Gilfillan division is grouped with Honeywell Inc. Their doppler system, like Hazeltine's, would require a greater investment in airborne equipment than conventional scanning beam, because of the greater computing power required to determine change of frequency in signals. But the ITT Gilfillan system offers decision-makers a cheaper package alternative, important since most observers expect MLS to be more expensive than existing systems.

Texas Instruments was joined by Thomson-CSF of France in a conventional-scanning-beam venture. Acknowledging that its mechanical scanning-beam antennas are a disappointment, TI says it will use the Bendix-type electronic phased-array antenna if it gets a prototype contract. TI officials explain that the substandard mechanical antennas resulted from trying to get the brassboard models to the FAA on time.

The N-Channel RAM you've been waiting for.

**Simple to use.
Fast. Low cost.**

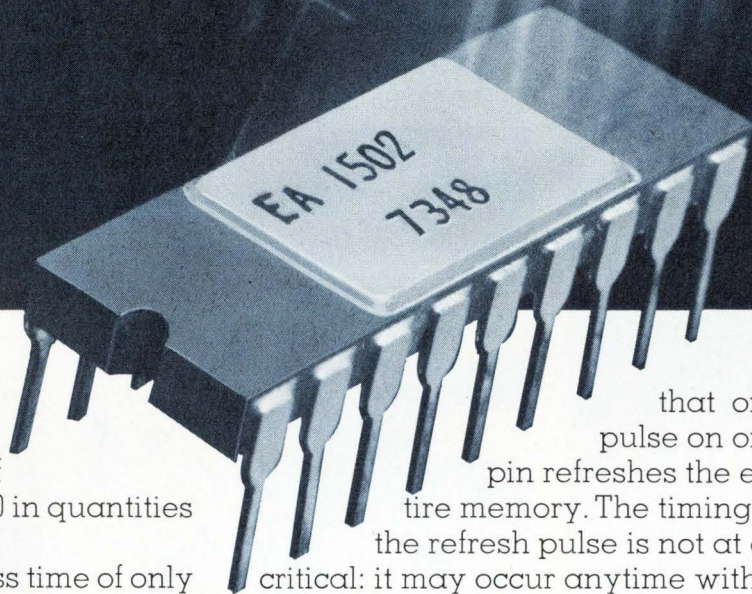

Here's the first 1024-bit MOS RAM to combine speed with simplicity of use at a low cost—\$13.50 in quantities of 500.

With a typical access time of only 130 ns and guaranteed maximum of 200 ns, the EA 1502 RAM is about five times as fast as the popular 2102.

And consider how simple it is to use:

Data and address pins wire directly to TTL logic without level shifters or pull-up resistors. The RAM needs only two supplies: +12v and -12v. It can be OR-wired to expand capacity. And it dissipates only 0.16 mW/bit power.

To achieve low power dissipation we made the RAM dynamic. But to keep use simple, we designed it so

that one pulse on one pin refreshes the entire memory. The timing of the refresh pulse is not at all critical: it may occur anytime within a 2-millisecond interval. And refreshing does not interfere with read/write cycles — your memory is never busy.

The pin-out of this 18-lead DIP is identical to the 1103. Although signal levels and shapes are different, you can replace 1103s with this speedier RAM without a total rework of your PC board.

The EA 1502 is in stock right now at our nationwide distributor, Cramer Electronics, and at Electronic Arrays, Inc., 550 East Middlefield Road, Mountain View, Calif. 94043. Phone (415) 964-4321.



Commercial electronics

Solar cell R&D may get cash boost

Federal agency proposes \$1 billion outlay over five years; \$271 million is earmarked for photovoltaic work

by Larry Marion, Washington Bureau

When a recent Government study concluded that 1% of the nation's electricity could be generated by photovoltaic solar cells by the end of the century, engineers and industry leaders reacted with a shrug. But what they didn't realize, says a National Science Foundation solar cell expert, is that even to produce only

that 1% "it will take a company the size of General Motors to produce the solar cells necessary."

Solar-cell research and development is on the verge of receiving a much-needed boost from the U.S. Government in the form of a huge increase in funding. John Sawhill, administrator of the Federal Energy Administration, recently announced an NSF proposal to spend \$1 billion over the next five years for R&D, and the big increases have already be-

Heating up. Solar cell experimental tower at left was set up by NASA in course of research project.

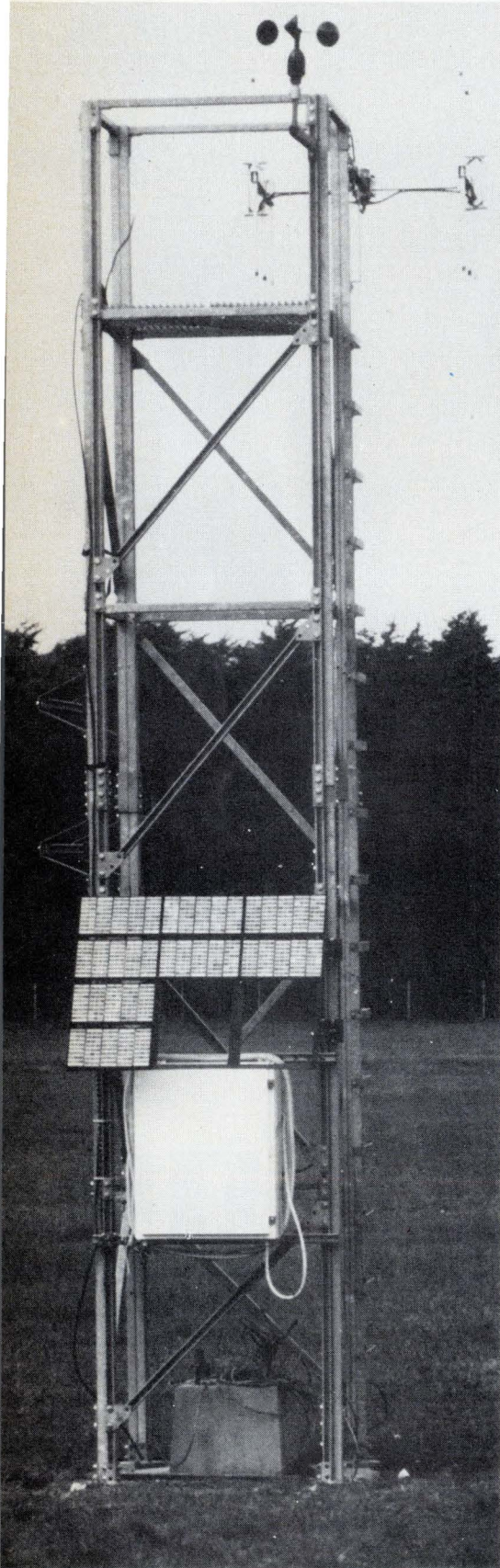
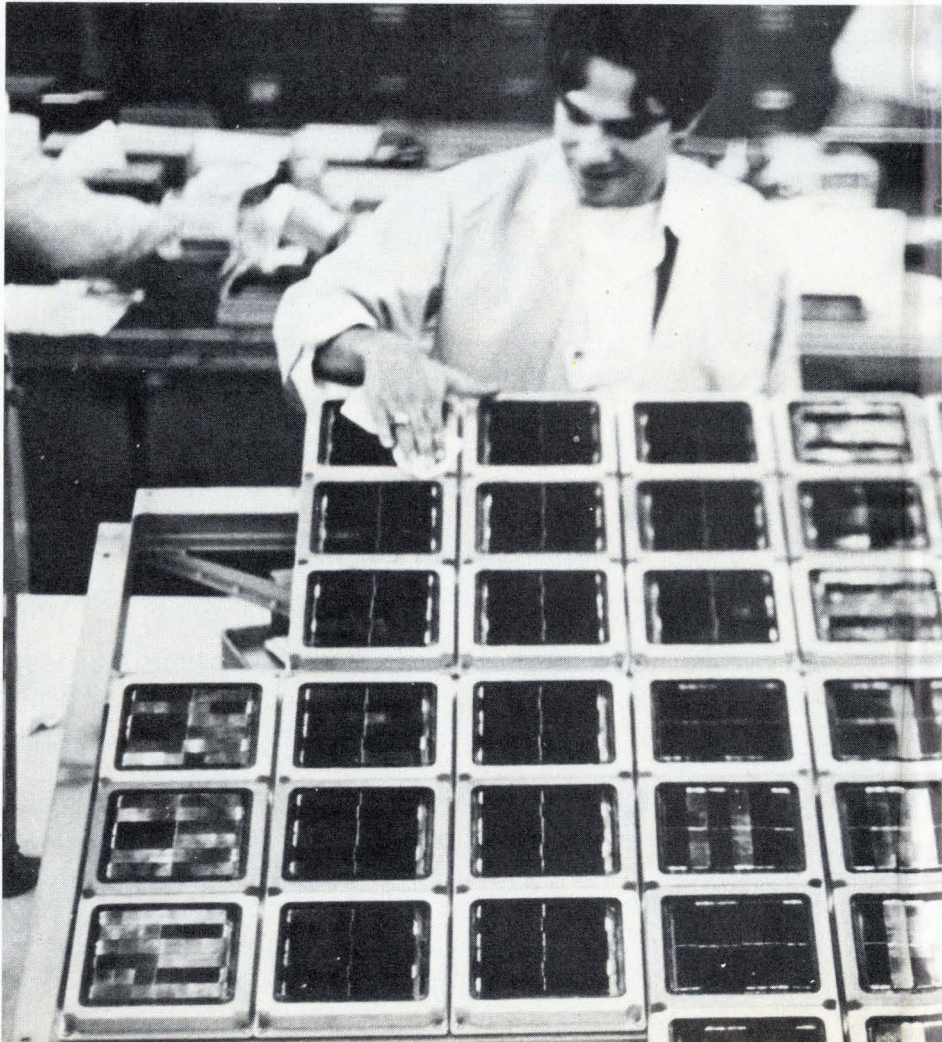

gun in the current 1975 fiscal year—from \$2.2 million in 1974 to \$8 million. Included in the five-year plan is a whopping \$271 million over the five years for research into photovoltaic cells, which works out to an average of more than \$54 million annually.

Motherhood. "Solar energy will join apple pie and motherhood as symbols of America," says the aide to one high-ranking Congressman on a House energy subcommittee. The aide predicts that the \$1 billion proposal now being reviewed by the President's Office of Management and Budget will be appropriated by Congress, which has already shown its interest in solar-energy development. For instance, a \$75 million solar-energy R&D authorization bill, which advocated passage of a long-term research effort of \$1 billion, first passed the Senate and sailed through the House in September by an overwhelming vote of 383 to 3. And key senators Hubert H.

Shining. Finishing touch is applied by a Centralab employee to 85.5-watt solar array headed for Air Force firing range.

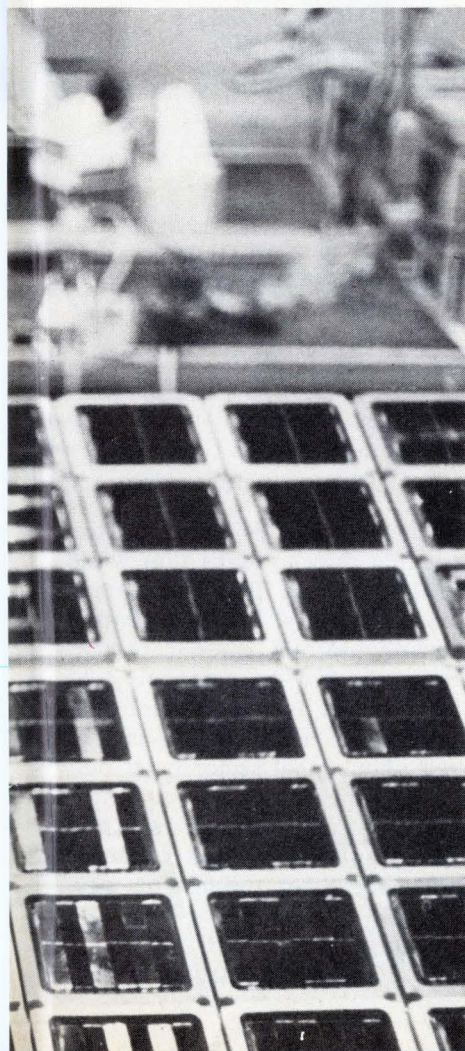

Humphrey (D.,-Minn.) and Henry Jackson (D.,-Wash.), who have pushed solar bills through the Senate, support the \$1 billion research proposal.

On Capitol Hill and in the White House, energy R&D proponents await the results of a proposed \$2 million National Science Foundation study specifically detailing what should be done to bring solar energy research in line with the multibillion dollar nuclear and coal-conversion R&D efforts.

"It is obvious to us that we need a commitment to solar energy," comments an aide to Rep. Mike McCormack (D.,-Wash.), who was a nuclear chemist for the Atomic Energy Commission before being elected to Congress. Funds for the NSF study are authorized in the \$75 million bill awaiting the President's signature. Another \$79 million is expected to be requested from Congress next spring.

The total, \$154 million, would represent the first two years' expenditures under Sawhill's five-year research plan.

More than \$242 million would be spent on solar-energy research in the 1966-67 fiscal year, including \$63 million on photovoltaics. By 1979, an annual expenditure of \$85.7 million is contemplated for photo-cell research. The upward trend reflects initial seed money for laboratory research, but by the end of the five-year program the Government expects to have at least one central electricity-generating station as what is known as a proof of concept.

"The energy issue made it clear that certain areas of energy have not been developing as fast as perhaps they should have," says Frank Zarb, associate director of OMB for energy and science. He accentuated the Administration's interest in developing solar and geothermal power after the recent signing of the Energy Research and Development Administration (ERDA) Act, which combined energy R&D efforts of six federal agencies under one roof.

Government officials have not yet determined how the R&D funds would be divided among the agencies. There are preliminary indications that NSF will continue to

fund research projects and that the fledgling ERDA, which will begin operations in 1975, will assume responsibility for demonstration projects. ERDA also might fund feasibility studies of solar electric power plants in the 1 to 10 megawatt range, he says.

Demonstration projects will go beyond this to establish commercial viability, something on the order of a 500-megawatt plant adequate to supply power to a typical small American city.

Research. NSF's Richard Blieden, until recently NSF chief for photovoltaic research and now deputy director of the Advanced Energy Technology R&D division, says that research in materials science and manufacturing technology are needed to bring costs down. "Somebody has to put the money down to attract the semiconductor companies to begin mass production of solar arrays," he says. That view is echoed by solar-cell expert Joseph Lindmayer, president of Solarex Corp. of Silver Spring, Md. But Lindmayer says that some extensive changes in manufacturing processes must be perfected first.

An NSF status report released last month lists the following development milestones:

- Designs for an automated production plant for solar cells and arrays by 1979.
- Completion of a 400-kilowatt power station in 1980.
- A large facility for fabrication of single-crystal silicon substrate sheets by 1982.

However, all these goals might be pushed up in the foundation's forthcoming study.

FEA and NSF sources say that a study done by Spectralab for the FEA, to be released by the end of the year, concludes that the current cost of solar-cell arrays, about \$20 per peak watt, could be reduced to \$1 per peak watt by mass-producing the cells by means of modified automated semiconductor-fabrication machinery. "You can only go so far with today's automation techniques, though," said Blieden. "To get competitive, there must be a further cost reduction of between 25% and 50%. That's where the research comes in." □

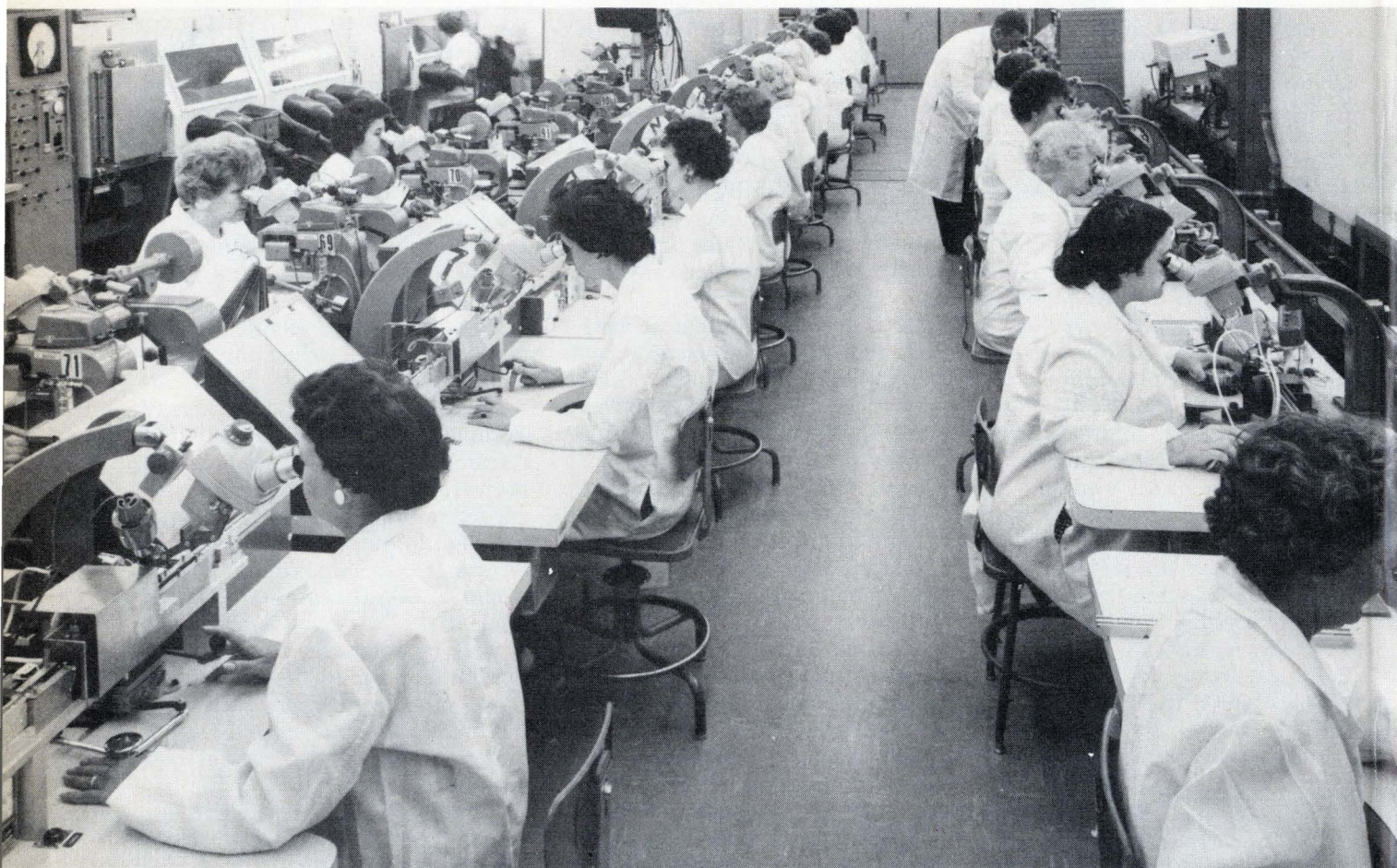

Busy hands. The problem for some calculator-chip suppliers is to keep their production lines as busy as this one.

Commercial electronics

Calculator-chip business slows

Some makers turn MOS capability to memories and microprocessors
as consumer-sales slump leaves them with excess capacity

by Paul Franson, Los Angeles bureau manager

The softening of the consumer-calculator boom is causing MOS-chip makers to look for additional markets. While most say that things aren't as bad as they look, the need to sell other types of circuits, notably memories and microprocessors, is more pressing for the smaller independent suppliers than among the big vertically integrated manufacturers.

At least one supplier, American Microsystems Inc. of Santa Clara,

Calif., has begun to ease out of the low-end market. Bernard T. Marren, AMI's president, says the reason is that "so many companies are vertically integrated. We are not a major source of devices." AMI will emphasize its digital-watch kits, in anticipation of what Marren predicts will be a large market in 1975.

By contrast, at National Semiconductor Corp.'s Semiconductor division, the problem is to find more MOS capacity—at least until the

Christmas rush ends. Gene Carter, marketing director, says that while "the marketplace [for the higher-priced calculators] has disappeared, we could use 50% more capacity" because the low-price models sold by National's Novus division are doing so well. But National is prepared, should that sector peter out. The watch market is "just coming," Carter says, and he believes it will soak up any excess MOS capacity. Novus recently introduced its first



Chances are you own a continuously tunable electronic filter. So by now you probably realize that continuously tunable filters are low performance instruments with, at best, 5% accuracy. And with poor reproducibility of settings, poor frequency accuracy and poor phase drift characteristics. And although continuously tunable filters provide infinite resolution, most users find infinite resolution neither important nor desirable unless there's corresponding accuracy.

But all this isn't why we say "junk it."

WHAT YOU SET, ISN'T WHAT YOU GET.

Take a look at the graph. As you can see, the front panel filter settings don't tell you the -3dB cutoff frequencies, the bandwidth, the noise bandwidth, and the center frequency. Or the insertion loss. You have to measure them — a time consuming, costly procedure.

THERE'S A BETTER WAY.

Ithaco offers two types of filters with switch selectable frequency settings. One type has 3 decimal digit frequency resolution for the user who not only needs resolution but also wants to know where he is without measuring.

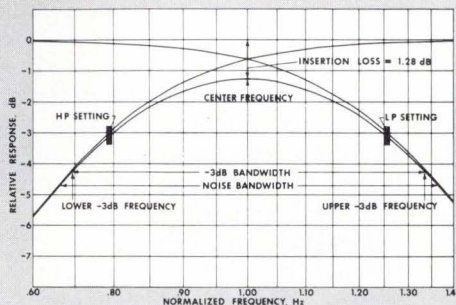

Normalized gain, attenuation, phase, and pulse response curves are printed on top of the filter. The other type uses the internationally accepted 1/10 decade [1/3 octave] frequency step — so you can operate with octave, decade and other convenient band pass settings, and still have sufficient frequency resolution for general lab and data acquisition applications. These filters have all the information shown on the graph printed on top — for all filter settings. And that's why we say "take your laboratory filter and junk it."

MORE NAILS IN YOUR FILTER'S COFFIN . . .

Standard accuracy of all Ithaco filters is $\pm 1\%$ in frequency, $\pm 2^\circ$ in phase, and $\pm .1\text{dB}$ insertion loss — all at least twice as good as the best the competition can offer. Plus, output drift is an order of magnitude lower than the competition. And self-noise is minimal. Best of all, Ithaco filters are competitively priced.

NOW THAT YOU NEED A NEW FILTER . . .

Write to Ithaco Inc., 735 W. Clinton Street, Ithaca, N. Y. 14850. Or, if you can't wait [we understand] call 607-272-7640, TWX 510-255-9307.

Take your laboratory filter and junk it.

ITHACO

Circle 57 on reader service card

1

AMERICAN MADE

Tolerance

SCHAUER

1-Watt

ZENERS

Immediate Shipment Low Prices

ANY voltage from 2.0 to 16.0

Quantity Price each

1-99	\$1.07
100-499	.97
500-999	.91
1000-4999	.86
5000 up	.82



All welded and
brazed assembly

No fragile
nail heads

Gold
plated
leads

Write for complete
rating data and other
tolerance prices.

Buy the kit— Save a lot



Kit contains a 51-piece assortment of SCHAUER 1% tolerance 1-watt zeners covering the voltage range of 2.7 to 16.0. Three diodes of each voltage packaged in reusable poly bags. Stored in a handy file box. Contact your distributor or order direct.

A \$54.57 value for

ONLY **\$24⁵⁰**

Semiconductor Division

SCHAUER

Manufacturing Corp.

4514 Alpine Ave. Cincinnati, Ohio 45242
Telephone: 513/791-3030

Probing the news

line of electronic watches and clocks, broadening its assault on the consumer market.

Electronic Arrays Inc., the Mountain View, Calif., firm that ships 60% of its output in calculator chips, still has a "major position in the desktop business-machine-chip market," says David C. Conrad, director of marketing. "We don't expect that market to go away," he adds. Conrad admits that, "in the long-term, the whole calculator market is going to be highly susceptible to vertical integration, as happened with the hand-held calculator," but Conrad looks to the independents—like Commodore and Keystone—to keep his company afloat in the calculator-chip pond. For now, he says, "we have no program to get out—though when it's no longer profitable, we'll drop it."

Hedging. Still, Electronic Arrays is hedging its bets a bit by designing "several products utilizing p-channel metal gate for other segments of the marketplace," says Conrad. Those include consumer products—possibly appliances, but no watches. In addition, the company will be "increasing its percentage of the p-channel metal-gate business in the ROM area," says Conrad.

Texas Instruments, now the largest chip maker and calculator assembler, says business is still booming. Charles Clough, marketing vice president at TI's Semiconductor group in Dallas, notes, "We haven't seen any softening from the vantage point of a supplier of chips." He notes, however, "a very large part of our business is in support of our own activity, but we sell outside to four of five customers."

Other firms haven't fared as well. The second-place chip supplier is Rockwell International's Microelectronics group, which has had extensive layoffs to readjust activity to the new level. President R. S. "Sam" Carlson says the softening came into focus fairly fast around May, "and it hit full force in July." Both slowdowns in new orders and cancellation of old orders caught Rockwell with heavy inventory, Carlson says, "but we've got that down now.

Carlson maintains that business hasn't actually turned down, "it just stopped growing at the phenomenal rate we had seen." He thinks the chip business will stay level until the heavy retail inventory is used up, then pick up again. However, Rockwell is also heavily involved in assembling calculators, and this may help it weather future blows. Carlson says the units recently introduced under the Rockwell name are doing well, even though they hit the market in the middle of the downturn. Rockwell is also poised to enter the watch business; it's also preparing to produce standard memory devices to soften its dependence on calculators.

A major supplier of chips, Western Digital Corp. also is sanguine, although it's increasing its noncalculator business. Marketing manager Stephen B. Stuart says the business has slowed, but "we see it firming up. I'm beginning to get more optimistic." Western Digital has come on strong as a chip supplier this year, Stuart says, partly because the firm has been using the silicon-gate process since its founding, giving it a leg up in device density. Western Digital may also be helped by TI's and Rockwell's aggressive moves into competition with former chip customers.

Margins. Stuart notes that prices on chips have been halved since a year ago—from \$8 to \$10 for a calculator chip to an average selling price of \$4 to \$5. He says his company is making money on the calculator chips—"though the margins were better before." Stuart doesn't see any reason to withdraw from the business, but he foresees shakeups and dropouts ahead in the chip and calculator markets. "The vertically integrated manufacturers will account for 50% to 55% of the machines bought—the rest is available to us, and that's a pretty big number." Stuart estimates that the worldwide hand-held calculator market this year will be 21.5 million units, down from the earlier industry estimate of 29.5 million. He pegs next year's total at 34 million.

Despite this, there are heavy bets on noncalculator markets for Western. Three-quarters of the firm's business was in calculator chips in

its fiscal year ending in June, with only 17% in computer/terminal chips (the rest of the sales were in LSI test systems). But president Alvin B. Phillips wants to double the company's sales with a much larger percentage of business in the computer-terminal business.

The major growth is expected in 4,096-bit random-access memories, with volume production starting this month, and in microprocessors. Western Digital is also developing the chip set for Digital Equipment Corp.'s LSI version of the PDP-11.

Other companies are taking the same approach. Rockwell's Carlson says consumer calculators now account for about 40% of the firm's MOS business, down from 50% last year, despite doubled sales volume. Higher-end business calculators account for 30%, other business machines 20% and in other parts 10%. Rockwell is heavily involved in microprocessors, with its 4-bit parallel processor unit used in higher-capability calculators and business machines, and the newer 8-bit PPS going into volume production, starting in January. Carlson says the microprocessor business, like the calculators, is profitable.

Memories. Rockwell also recently entered the standard-memory business, with one aimed at the high-volume 1,024-bit RAM market. TI is active in memories, and its 4,096-bit device is a major factor in the industry now that production problems are straightened out—as they appear to have been. Mostek Corp., across town from TI in Carrollton, Texas, has for years been trying hard to increase its percentage of noncalculator business, with telling results. Only 20% of its 1974 MOS sales will be in calculator chips—down from 90% in 1970. Memories will account for 60% this year, and custom chips 20%.

In contrast to Mostek, MOS Technology, Norristown, Pa., has maintained its calculator sales at 70% of the total over the past year and doesn't appear to be hurt as a result—though it plans to change that ratio. In the next 18 months to two years, MOS Technology expects its percentage of MOS-chip sales to decline as its memory and microprocessor activities expand. □

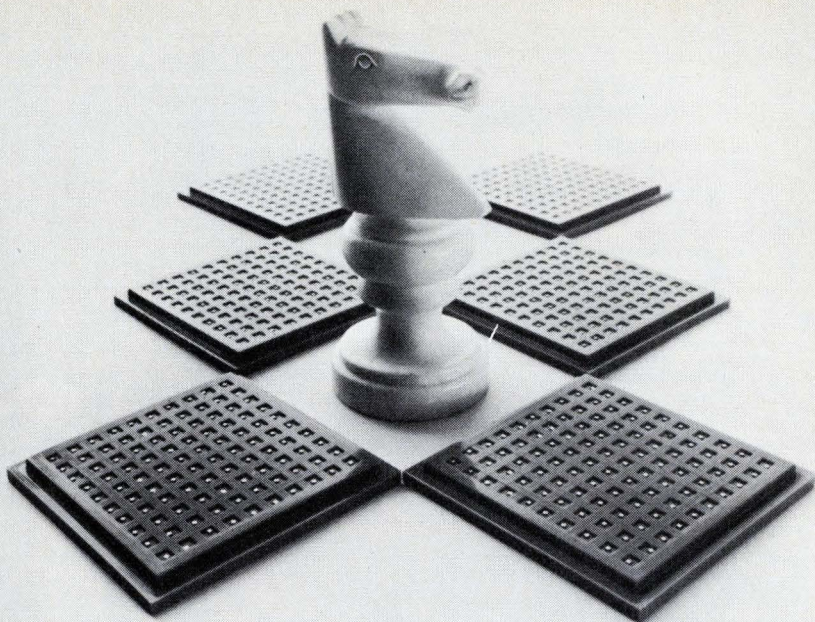

Our resistor chips: Your move.

30-MIL thin-film-NiCr Resistor-Chips.

RESISTANCE RANGE: 10 Ω to 510K Ω .

TEMPCO: 0 to +50 PPM/ $^{\circ}$ C.

TRACKING MATCH: ± 1 PPM/ $^{\circ}$ C.

POWER DISSIPATION: 250 mW. **NOISE:** 0.01 μ V/Vmax.

RESISTANCE TOLERANCE: ± 1 and $\pm 5\%$

(or tighter, by request).

TEMPERATURE: -55° C to $+125^{\circ}$ C.

MIL—STD—883 A or B. GLASS PASSIVATED.

CONFIGURATION: chips, wafers,
multi-chip trays, tube packs.

For Fast Action, Call:

In USA: (617) 272-1522 (or TWX 710-332-7584)

In Europe: Hybrid Systems Europa GmbH, 61 Darmstadt,
Luisenplatz 4, Germany. Tel. 6151-291595 TELEX 841-419390

Hybrid Systems Corporation
Burlington, Massachusetts 01803

Hybrid Systems
CORPORATION

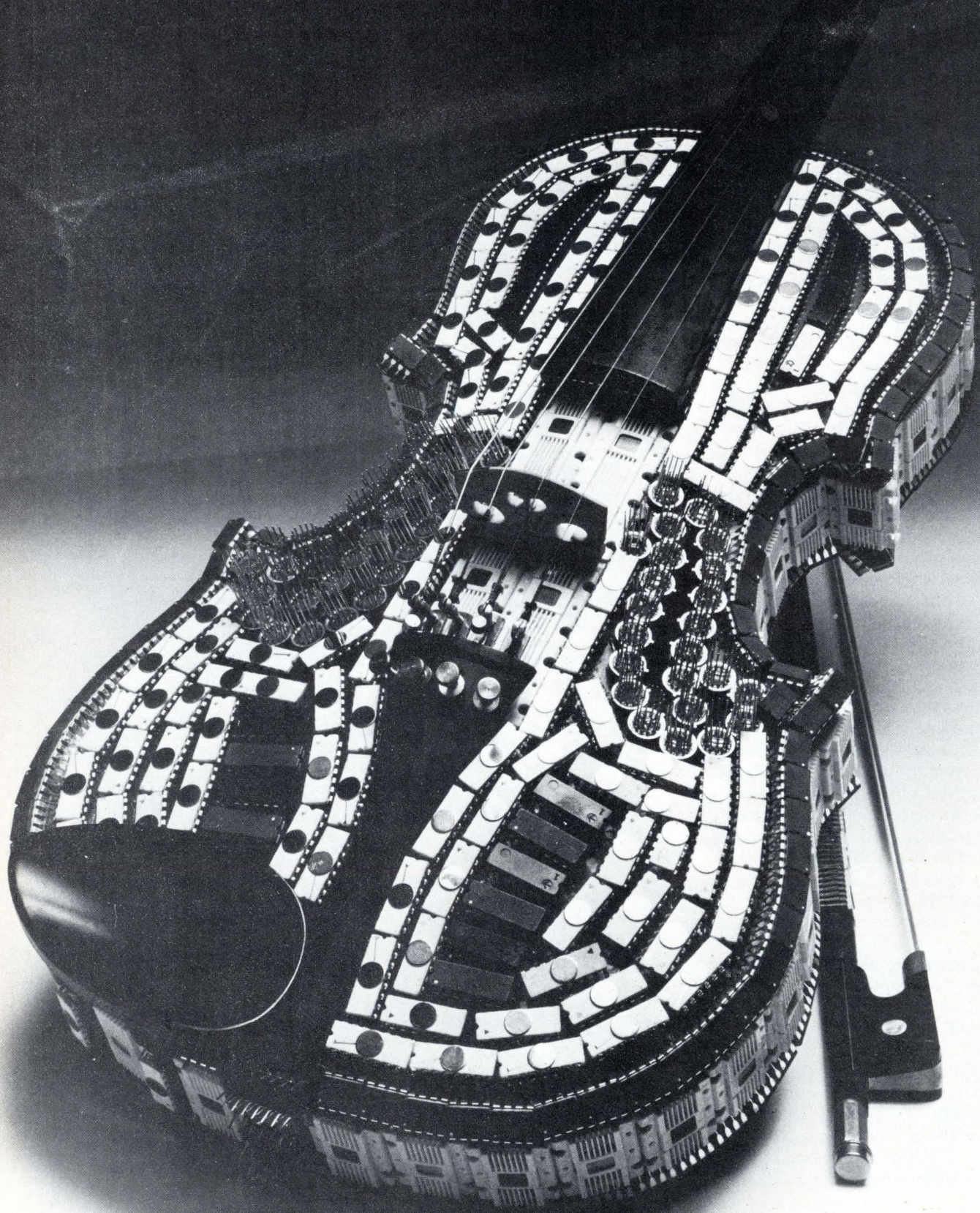

Why RCA can now play second fiddle as well as first in Linear ICs.

Types	F	M	N	T	RCA
301 Family					X
307 Family					X
308 Family					X
311 Family					X
339 Family					X
723					X
741					X
747					X
748					X
1541					X
1558 Family					X
3018					X
3019					X
3026					X
3039					X
3045					X
3046					X
3054					X
3081					X
3082					X
3083					X
3086					X

As the chart points out, you've got a whole new source for some of the most asked-for LIC numbers in the industry. It's RCA.

Just "X" the appropriate blocks for your present suppliers and compare with the RCA column.

Yes, it's good old RCA.

A company that made its first commitment to proprietary and custom LICs, and now becomes an excellent source of the standard types you use in quantity.

A company long known for its capabilities in consumer LICs. A company that pioneered many of the advanced techniques in linear technology.

A company that offers a line

of industrial LICs as broad as anyone in the industry.

In short, a company that's not just a half-way LIC house. But a full house. A house featuring original types, custom types, popular standard types and even chips.

A full house is more than just products. It's full engineering support. It's a wide range of packages. And it's a national distribution network, featuring the best distributors in your area.

The fact is, whatever you want in LICs, RCA has a lot to offer. Contact your local distributor and fire a few popular numbers at him. Ask him what he has on his shelves. Find out what a full house means.

You might want to try RCA as another source of standard types. As a proprietary source or a custom source. But we want you to try us. And if we don't happen to have what you need, chances are we can make what you have in mind.

For more information, and a free cross reference guide and wall chart, write to your local RCA Solid State distributor, or RCA Solid State, Box 3200, Somerville, N. J. 08876. Phone: (201) 722-3200, Ext. 3145.

RCA Solid State
A full house in Linear ICs.

Packaging & production

PC-board changes may mean woes

Anticipated tightening of glass-fiber-making rules will reduce pollution but could result in materials with different characteristics

by Andy Santoni, Instrumentation editor

It hasn't hit the electronics community yet, but changes in the glass-fiber material that is the backbone of many printed-circuit boards may have adverse effects on the properties of those boards. Just how much those changes will involve users is still something of a mystery, but board makers are nervous.

Cause of the concern is the likelihood of tighter environmental standards governing air pollution in the manufacture of glass fiber. Expecting the U.S. Environmental Protection Agency to implement those standards by the middle of next year, Owens-Corning Fiberglas Corp., with headquarters in Toledo, Ohio, is investigating changes in the processing methods and chemical composition of the kind of fiberglass used in pc boards—and users aren't happy with what they've seen so far.

Owens-Corning has delivered samples of one new formulation—called E-3709—to some of its customers. Initial tests show E-3709's physical properties vary markedly from those of the industry-standard "E" glass (see table). How much will this affect pc-board users? That's the big question, but preliminary data shows weaker dielectric figures, though the new material does have better tensile strength.

What puts pc-board laminators and etchers in a double bind is that glass-fiber yarn is in short supply, and since Owens-Corning is one of only two suppliers (PPG Industries is the other), the fiber weavers, which

supply fabric to the laminators, can't simply go out and find another source. If, as some expect, the EPA puts standards into effect by its target date, next July 1, and if by then Owens-Corning hasn't found an acceptable process change that doesn't alter its yarn formulation, there could be a severe shortage of pc boards.

Owens-Corning feels that since environmental standards are already affecting new plants, it's only a matter of time before more effective emission controls are required on older plants that produce fiberglass. Owens-Corning produces the bulk of its "E" glass at one plant—in Ashton, R.I.—and it wouldn't be easy to shift production to another area where environmental quality

standards are less stringent.

PPG, meanwhile, which produces glass-fiber yarn at two plants in North Carolina, has no plans to change its "E" glass composition at this time. "We comfortably meet all effluent requirements of the state," says Carter Schriber, manager of textile marketing for the firm's Fiber Glass division, Pittsburgh. PPG has attacked air-pollution problems by installing a "dry scrubber" and is investigating a modification of its manufacturing process as a longer-range solution, says Schriber.

Henry Fall, technical service manager at J.P. Stevens Industrial Fiber Glass division, Slater, S.C., says there is enough "E" glass available right now, and there has been no immediate need to force cus-

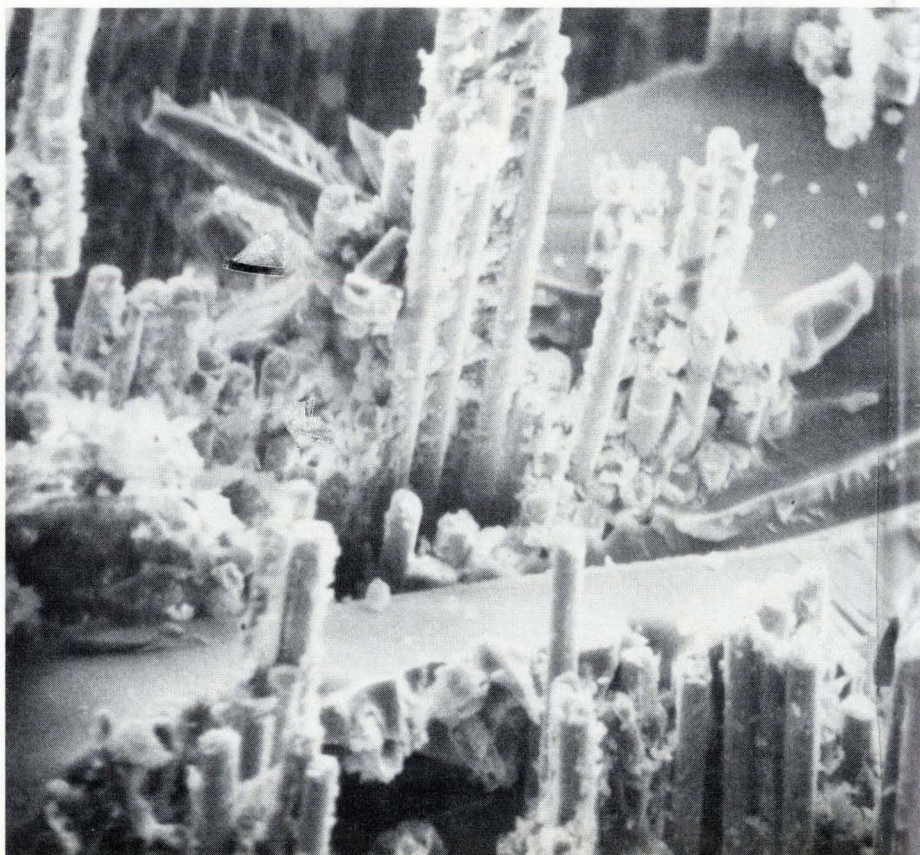

Jumbled. Scanning electron micrograph of E-3709 glass-fiber yarn from Owens-Corning Fiberglas shows poor adhesion of fibers to resin matrix and to themselves.

E GLASS vs E-3709

PROPERTY	E GLASS	E-3709
Specific gravity, g/cc	2.51	2.71
Tensile strength, psi	500,000	5,000,000
Tensile modulus, psi $\times 10^6$	10.5	10.5
Refractive index, 500 microns @ 32°C	1.549	1.584
Dielectric constant @ 72°F, 60 Hz	5.9 - 6.4	7.0 - 7.1
Dielectric constant @ 72°F, 1 MHz	5.8 - 6.3	6.9 - 7.0
Dielectric strength, volts/mil	276	253

tomers to switch to E-3709, because "demand has dropped off tremendously" during the present slump in the electronics industries. Stevens is not pushing E-3709 except where high-pressure laminating is not involved, Fall says, "and we don't want it unless it's forced down on us."

But since business is expected to pick up again next year at about the same time as the more stringent EPA regulations may go into effect, all involved—yarn producers, fabric weavers, and board laminators—are scurrying to find a solution.

Howard A. Schudel, manager of technical service at the General Electric Laminated & Insulated Materials department, Coshocton, Ohio, believes "there's a lot of work

to be done before anyone can use E-3709." GE's investigation of the new formulation has revealed differences between E-3709 and "E" glass in both electrical and mechanical properties. Schudel's conclusion is that E-3709 is "inferior." Keeping two different materials in inventory, he adds, is yet another facet of the problem. "It's going to be very difficult to keep these things separate," he says.

Denis Vaughan, R&D director at Clark-Schwebel Fiber Glass Corp., Anderson, S.C., frowns on the possibility of mixing the two yarns into a single material. This "would cause havoc," Vaughan says, because no one could be sure of what properties to expect.

The two yarns look, clean, and weave alike, Vaughan notes, but, "when you apply coupling agents [necessary for the laminating process], they no longer behave the same."

Clark-Schwebel "may have overcome the worst of the problems," Vaughan hopes, musing that "it's like re-inventing the wheel."

"E" glass has been around a long time. It was first used some time in the 1930s, notes Robert Frank, manager of planning and market research at Burlington Glass Fabrics Co., New York, and became an important factor in the pc-board market during World War II. Over the years, mounds of data on the physical and electrical properties of "E" glass have been accumulated, something that can't be said at this early date for E-3709.

Says Clark-Schwebel's Vaughan, "If we don't solve this, we've put the industry back ten years." □

HIGH PURITY ELEMENTS

We offer more than anyone else.

- Antimony
- Arsenic
- Bismuth
- Cadmium
- Copper
- Gold
- Indium
- Lead
- Selenium
- Silver
- Sulphur
- Tellurium
- Thallium
- Zinc

Asarco has the broadest selection of high purity elements in the business. All 99.999+ % pure. All ready for prompt delivery. For semiconductors, electronics, metallurgy, research, and other applications.

Our high-purity elements are also available in commercial quantities.

For more information on Asarco's array of high purity elements, write our By-Products Department at 120 Broadway, New York, N.Y. 10005.

75 Years of Progress in Metals

ASARCO⁷⁵
American Smelting and Refining Company



Testing boards is one thing. Troubleshooting them is quite another.

As boards become more complex, and the production quantities increase, automatic testing becomes a necessity. In fact, it is relatively easy to justify the cost of a system for testing PC boards when you consider what your alternatives are. However, what many who look into test systems fail to realize is that with the typical automatic test system at least 50% of the **total** operating costs are attributable to troubleshooting time. It appears, then, that the system that minimizes troubleshooting time and expense will probably prove to be the least expensive system over its lifetime.

The GR1792 Logic-Circuit Test System, with its incomparable CAPS software package, removes the human element from troubleshooting as much as possible. In its automatic-fault-location (AFL)* mode, CAPS literally removes the operator from the troubleshooting procedure. Within seconds after a fail signal appears, the CRT displays a series of messages that resolve not only **what** the fault is but **where** it is located. It accomplishes this by an on-line simulation technique that provides a complete I/O pin comparison, thus investigating **all** failure possibilities that could produce the symptom.

If you are in the process of investigating PC board test systems, look beyond the testing scene to see the whole picture. As time passes, most of your expense will be in board troubleshooting, and that is the point on which the GR 1792 and CAPS really pay off for you. Call or write for the complete story.

General Radio GR Test Systems Division

300 BAKER AVENUE, CONCORD, MASSACHUSETTS 01742

NEW YORK (N.Y.) 212 964-2722, (N.J.) 201 791-8990
BOSTON 617 646-0550 • DAYTON 513 294-1500
DALLAS 214 234-3357 • LOS ANGELES 714 540-9830
SAN FRANCISCO 415 948-8233
CHICAGO 312 992-0800
WASHINGTON, D. C. 301 948-7071
ATLANTA 404 394-5380
TORONTO 416 252-3395 • ZURICH (01) 55 24 20
TOKYO (T.E.L.) 03-343-4411

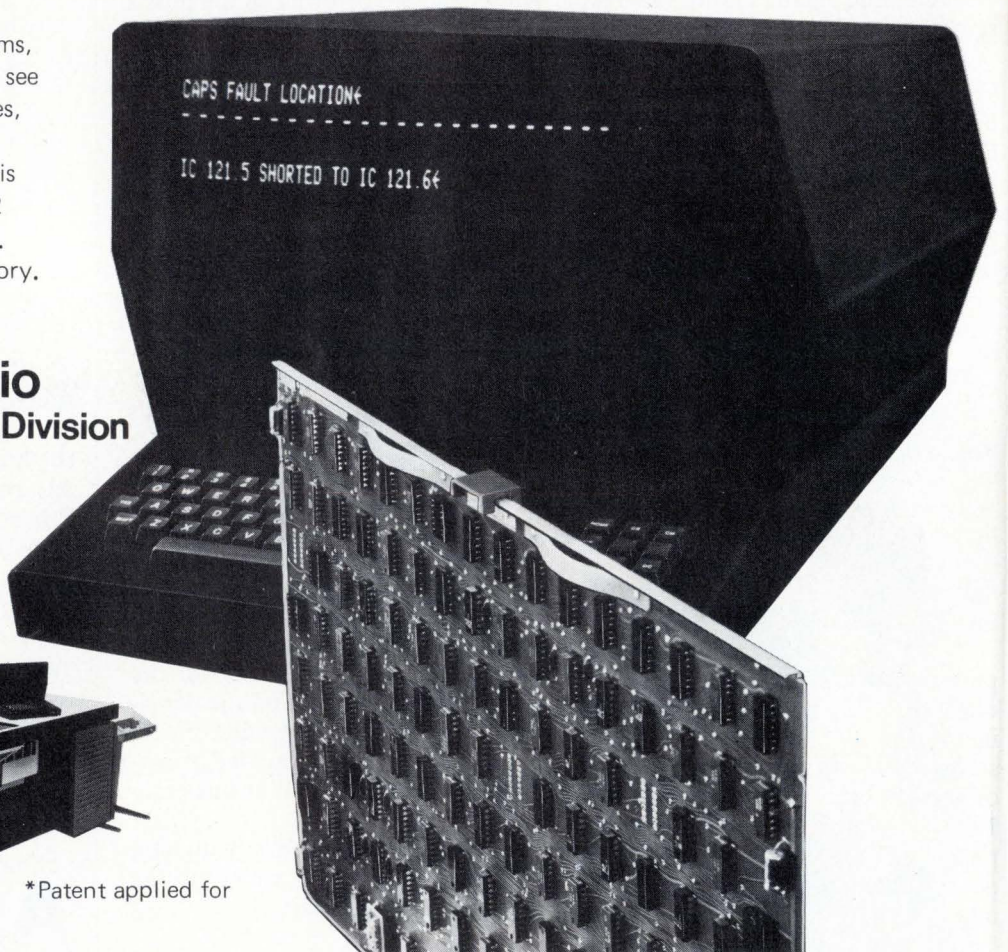
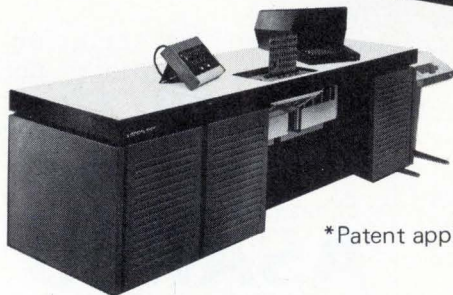

*Patent applied for

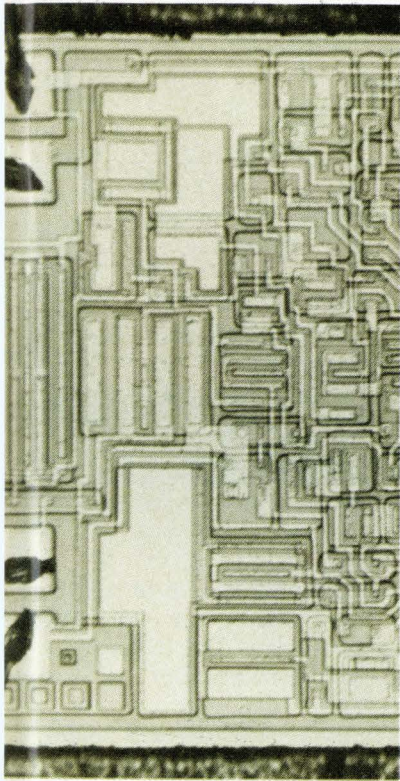

Better bipolar-MOS process yields linear ICs with good ac and dc specs

Even in the fastest 10-ns data-acquisition applications, monolithic linear devices now rival discrete circuits; in the lead are an inverting op amp, chopper, and current amplifier

by Jim Beasom *Harris Semiconductor, Melbourne, Fla.*

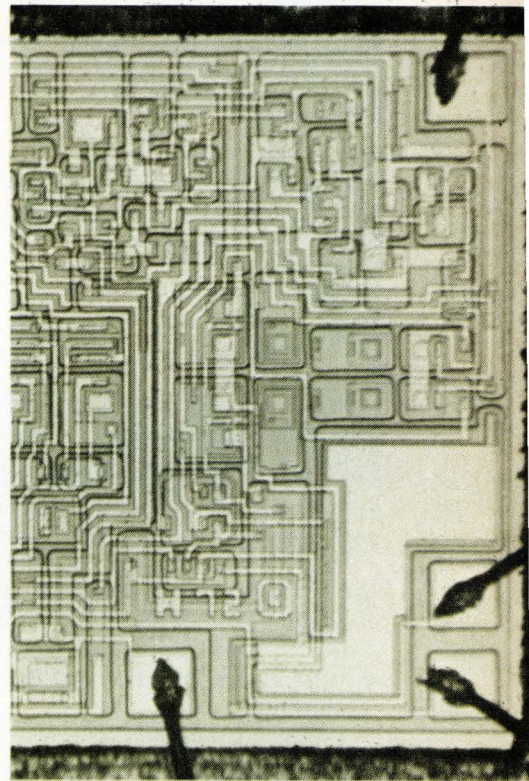

□ The precision and sensitivity of the best discrete linear circuits are easily matched by today's monolithic linear devices—so far as dc performance goes. That achievement is based largely on such bipolar processing innovations as, for example, the ability to build super-beta transistors and junction-FET inputs on chips. But until now none of the advances has done much for linear high-frequency performance.

A limiting factor in conventional linear ICs has been the low transfer frequency of the lateral pnp transistors used as complementary devices to the npn transistors. Hitherto a mere 1 megahertz, this frequency has now been boosted to 500 MHz by a new bipolar process that, in addition, upgrades several other ac parameters. What's more, these improvements can be further enhanced by being combined with the latest metal-oxide-semiconductor developments, such as the use of p-channel MOS input structures and high-current complementary-MOS outputs.

The improved bipolar-MOS process has already pushed linear high-frequency performance into the fastest 10-nanosecond data-acquisition range. A wideband inverting operational amplifier has been built with a slew rate of 300 volts per microsecond and a bandwidth of greater than 70 MHz (the best previous values were 100 V/ μ s and less than 10 MHz). And a new current amplifier can supply an output of more than half an ampere at 500 V/ μ s, as against the former 300-milliamper maximum in precision-input types.

The pnp and npn transistors on these devices benefit in several ways from the new bipolar process. It gives them a high-current capability so that they can directly drive the high-capacitance, low-impedance loads characteristic of high-frequency circuits. It also minimizes their isolation leakage and capacitance parasitics so that their full frequency range is realized.

However, to provide a high input impedance during operation at high current, a high-breakdown-voltage FET has to be added to the process. Bipolars cannot handle this job because their base current inputs increase linearly with their operating (collector) current. In contrast, FET gate current is itself a leakage current, one that's very small and invariant with the FET operating (drain) current.

A high transfer frequency and high-current capability can only be provided by shallow double-diffused pnp and npn structures. The pnp collectors require isolated p regions with p⁺ buried layers, and the npn collectors require isolated n regions with n⁺ buried layers.

Resistivity must be about 4 ohm-centimeters in the p region and 5 ohm-cm in the n region to achieve the 40-volt base voltage, collector-emitter open (BV_{CEO}), needed in linear devices. The p regions can also be used for n-channel MOS bodies, since the high resistivity will

The new linears. Adding a refined MOS process to analog chips boosts performance and increases density in today's monolithic linear circuits. This inverting op amp has an over-70-MHz bandwidth.

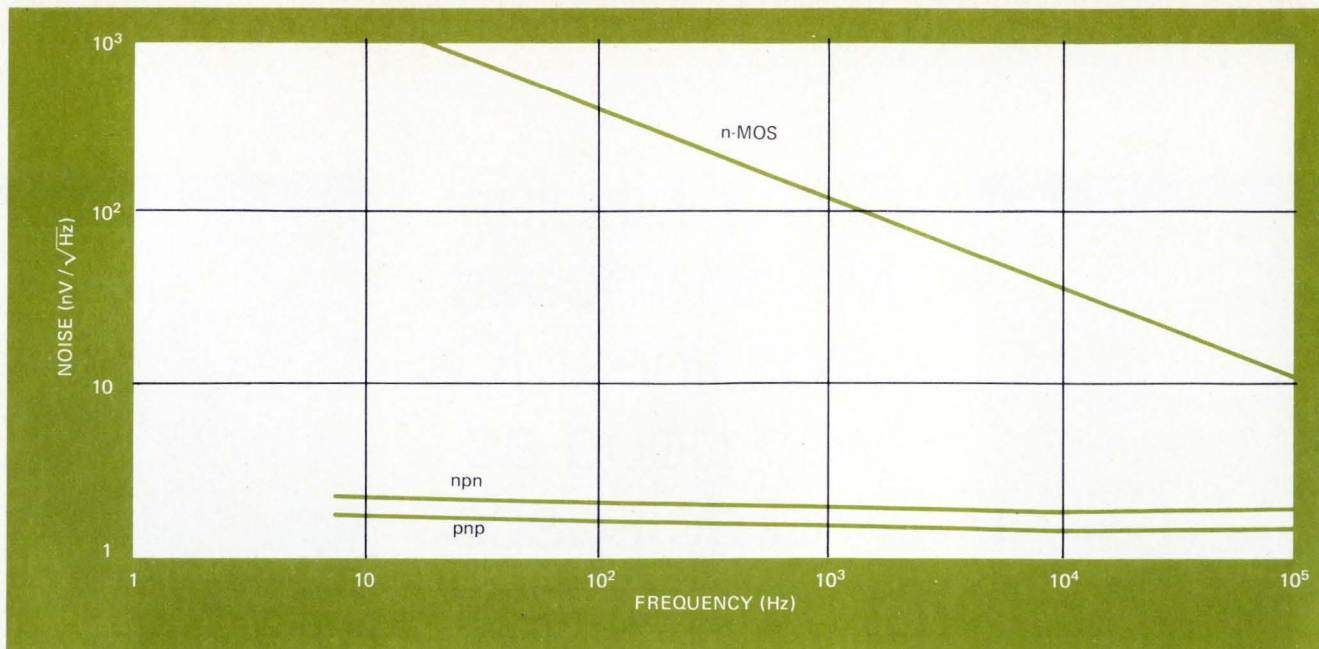

1. Noise tradeoff. Bipolar linear devices have a much better voltage-noise characteristic than do most MOS devices, which exhibit performance-degrading $1/f$ voltage noise. The n-channel MOS device, however, does better on current noise because gate current is small.

yield the desired depletion-mode devices. Likewise, the n regions can be used for p-channel MOS bodies, because the resistivity resembles that used in standard p-MOS fabrication and consequently yields devices with similar thresholds.

Finally, to wrap it all up, dielectric isolation eliminates the multifunction parasitic devices that plague junction isolation, holds isolation leakage currents to the negligible level of less than 1 picoampere, and reduces isolation capacitance significantly.

Why linear MOS

Along with the improved bipolar process there has arrived the ability to build MOS structures on the linear chip for both inputs and outputs. In principle, either JFETs or MOSFETs would satisfy the low-current input requirement of all linear devices. But MOS structures do it better because they can be operated at either gate polarity without degradation of input impedance. In contrast, JFETs use reverse-biased pn junctions as gates and therefore have the low impedance of a forward-biased diode when the gate voltage swings past the source voltage—a condition that only complex clamping circuits will correct.

In addition to performing linear functions, MOS devices can be used to build logic and memory circuitry, opening up the exciting possibility of combining all three functions on a monolithic chip. This linear LSI technology should significantly improve system packing density for such tough linear applications as digital-to-analog conversion, analog switching, and chopper-stabilized amplification.

Which type MOS?

Different MOS structures suit different linear circuit functions—amplification or switching, inputs or outputs. For amplifying, n-channel MOS is preferred to p-chan-

nel because its figure of merit (amplification over gate capacitance, or g_m/C_g) is about twice that of p-MOS. This follows because amplification is directly proportional to mobility, and the electron mobility of n-MOS is about twice the hole mobility of p-MOS.

In addition, the ideal amplifying structure will be depletion-mode MOS with a pinch voltage of about -1 V. Such a device can be biased at its operating current with a zero gate-to-source voltage, V_{GS} , that minimizes the supply voltage needed to bias the devices and thus leaves maximum voltage for the signal.

For logic and memory applications, high-output-impedance enhancement-mode devices are most useful—although they conflict with the n-MOS depletion-mode requirement for amplifying structures. Fortunately, depletion-mode devices intended for logic or memory can be shifted into the enhancement mode by the application of a reverse bias to this body-source junction—often called the back gate or body effect.

Linear MOS characteristics

The MOS devices available in this process are suitable for digital as well as linear applications. But although similar in structure to MOS metal-gate ICs, the three possible MOS structures—p-MOS, n-MOS, and C-MOS—must be understood in the context of linear circuits.

All p-MOS devices used to implement memory and/or logic functions on a linear chip can be built in a single isolated n-type island. The structure within that island is exactly like that of a conventional p-MOS IC, and the same circuit design and layout considerations apply. The only difference is that an n^+ diffusion must be made into the n island somewhere to provide a body connection, which in a purely p-MOS IC would be made at the back of the chip.

In most cases the supply voltage must be less than the 20-v yield threshold. If not, an n^+ emitter diffusion can

be used for channel stops. The n^+ diffusion can also be used to protect very sensitive circuit components.

Choice of supply voltages is very flexible. The simplest approach is to operate the MOS circuitry between one of the analog supplies and ground. If a lower supply is required, it can be developed on chip by, for example, a zener reference buffered by a pass transistor. Some applications require separate analog and digital supplies, to prevent digital glitches from disrupting the analog circuitry.

The number of power supplies can also be reduced. Assuming that the mixed-process chip is operating from positive and negative supplies, the body voltage can be developed from the negative supply by an internal circuit, thus eliminating one supply from the system requirement. The logic will then operate between ground and the positive analog or digital (if analog supply noise must be minimized) supply.

The role of C-MOS

Most recently, complementary MOS has been adapted to linear circuits because it offers the highest speed and lowest power dissipation. But these gains are generally made at the expense of lower packing density than with the other MOS types (C-MOS structures, having an extra p or n diffusion, are larger).

It's here that dielectric isolation becomes most valuable. There are several differences between a dielectrically isolated and conventional junction-isolated C-MOS device. They arise from the fact that in the junction-isolation process, the region in which the n-channel devices are built is formed by diffusion into the front of the wafer. As a result, the surface doping concentration is about 10 times greater than in the dielectric-isolation process. The more heavily doped surface causes about twice as much drain body and source body capacitance as in the dielectrically isolated devices, which are therefore faster.

On the other hand, the lower p doping in the dielectric-isolation process makes it necessary to use body bias to operate the n-channel devices in an enhancement mode (junction-isolated devices don't need body bias). Still, this voltage may easily be developed, as in the n-MOS case, from the negative supply that is always present with a linear chip.

Perhaps the most significant difference between the dielectrically isolated and conventional C-MOS device results from the way the p body regions are isolated in the two techniques. In the standard process the p region is separated from the n region by an active pn junction that equals the p region in area. To maintain isolation between the two regions, the junction is reverse-biased by connecting the p body to the most negative voltage in the circuit and the n body to the most positive voltage. Since this junction is typically over half the area of the entire circuit, its leakage current is quite large and contributes heavily to the static power dissipation of conventional C-MOS. In dielectrically isolated C-MOS, however, a passive isolation oxide replaces the pn junction and leakage across this barrier is less than 1 picoampere.

The presence of high-current bipolar devices in the

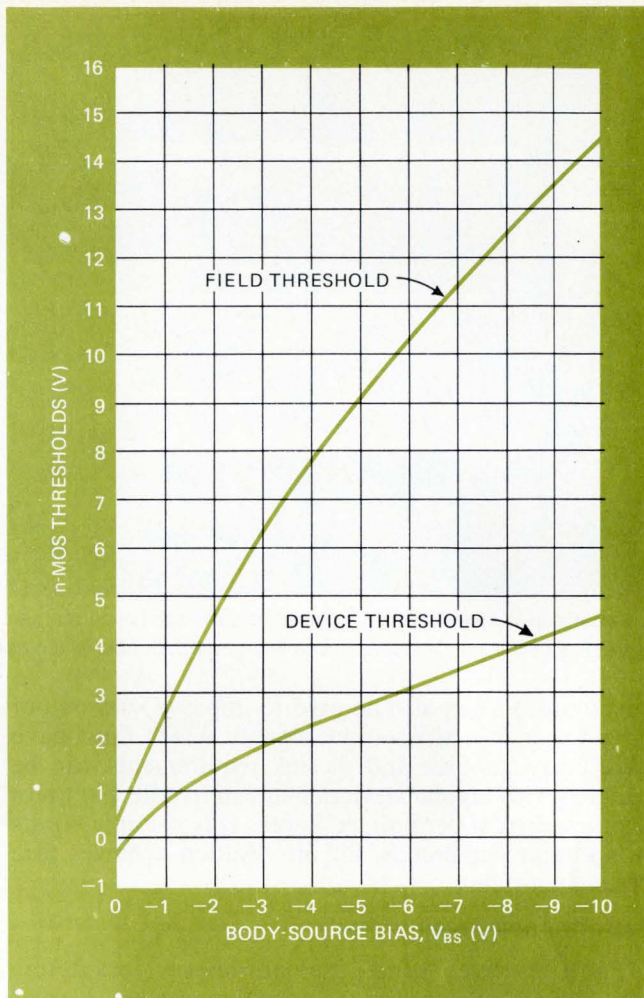

2. No threshold problems. With n-MOS linear devices, several volts of body-source voltage produce the standard 2-V threshold that is suitable for logic applications. Most important, the field threshold for the n-MOS structures remains comfortably out of range.

TABLE 1:
TYPICAL DEVICE PARAMETERS FOR
HIGH-FREQUENCY LINEAR INTEGRATED CIRCUITS

Parameter	npn devices	npn devices
Current gain (h_{FE})	150	400
Transfer frequency (f_T , peak)	600 MHz	700 MHz
Base voltage, collector-emitter open (BV_{CEO})	55 V	55 V
Offset voltage (ΔV_{BE})	0.3 mV	0.3 mV
Change in current gain (Δh_{FE})	10%	10%
Parameter	n-MOS devices	p-MOS devices
Threshold voltage (V_T)	-0.5 V	-2.5 V
Breakdown voltage (BV_{DS})	45 V	-60 V
Offset voltage (ΔV_{GS})	10 mV	10 mV

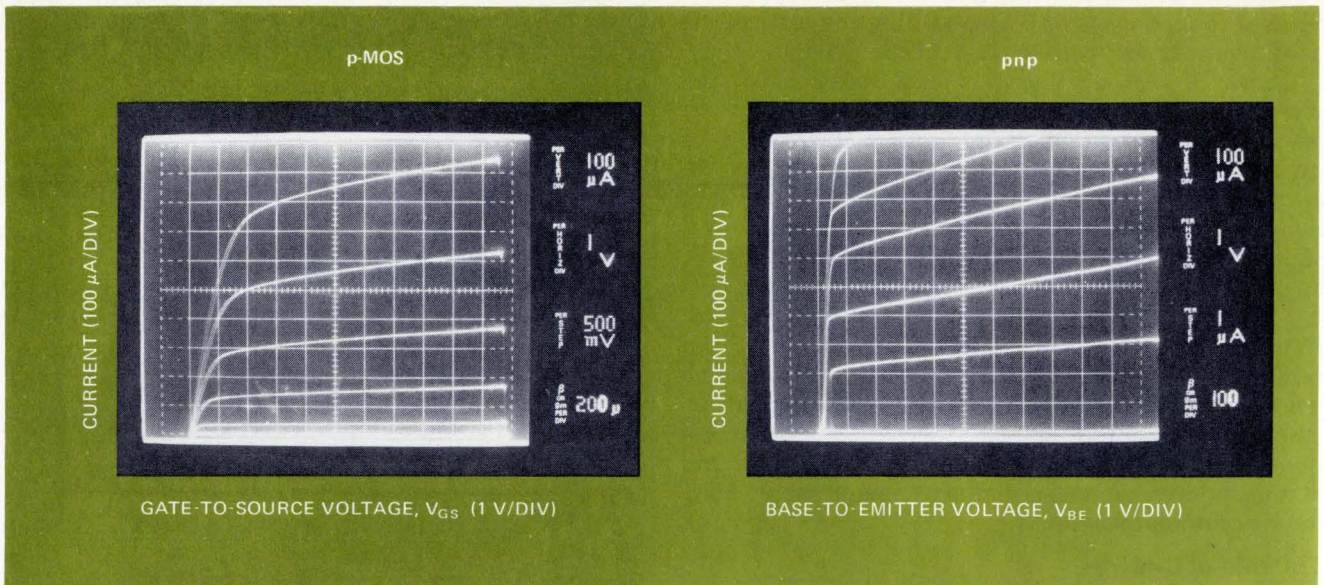

3. Getting up to speed. Bipolar pnp transistors reach full current values quickly, at a drive voltage of less than 1 volt, as shown by these 1-V characteristic curves. Comparison is with an n-MOS device, which needs a 5-V drive to obtain the same current value.

mixed process can also be used to improve MOS output drive capability. MOS output signals, which must have large current source and/or sink requirements, can be buffered with bipolar devices that can handle 100 times as much current per unit chip area. This not only boosts MOS output capabilities but in addition achieves true TTL compatibility.

Performance parameters

Table 1 gives some typical device parameters achieved with this process. Notice the excellent bipolar match parameter—the base-to-emitter offset voltage, V_{BE} —which is only 0.3 millivolt in both pnp and npn transistors. This low value is essential for precision circuit design. In contrast, the MOS gate-to-source-voltage (V_{GS}) match is a rather poor 10 mV and serves to limit the use of FET inputs to only the least precise applications. (JFETs also suffer from similarly poor match characteristics.)

Figure 1 shows the voltage-noise characteristics of the bipolar and n-MOS devices. The flat bipolar device noise compares favorably with the best low-noise discrete devices, but the n-MOS device exhibits the well-known $1/f$ voltage noise characteristic. The n-MOS device, however, has essentially no current noise since its gate current is so small compared to a bipolar base current.

The n-MOS device and field threshold variations with body source voltage are shown in Fig. 2. Several volts of body-source bias are enough to achieve the 2-V enhancement-mode operation required for logic applications. And at the normal operating voltage of 5 V and above, field threshold exceeds device threshold by at least 5 V, ensuring reliable operation.

Figure 3 compares the current-voltage characteristic of a 6-square-mil small-geometry pnp structure to the common-source characteristic of a 30-mil² p-MOS device. Note that 5 V of gate-to-source voltage is required to achieve only 800 microamperes of drain current in the p-MOS device, even for this rather large device,

while in the pnp structure 800 μ A is achieved with a V_{BE} of only 0.7 V. This means that, for an amplifier requiring high-current outputs, the bipolar device is far superior because it develops its saturation current output at a much lower voltage. Also, the pnp is in its active region of operation at $V_{BE} = 1$ V, while the p-MOS device requires a drain-source voltage of 3 V. This illustrates the point that FETs require more voltage to achieve their operating bias point and therefore leave less voltage for the signal.

Another illustration of the FET's high-bias voltage requirement is given in Fig. 4, which compares the current-voltage characteristics of a zero-biased n-MOS device having a voltage threshold (V_T) of -0.2 V (and therefore operating in the depletion mode) with the same device biased at a V_{BS} of -1.5 V and having a V_T of 1 V (an enhancement-mode device). In both cases the top step is V_{GS} of +5 V. Clearly, the depletion-mode device requires a much lower gate-source bias voltage to reach useful operating current.

The devices

The recently announced 2530 wideband inverting operational amplifier indicates the level of performance that can be achieved by teaming high-frequency, high-current bipolar elements with the right types of MOS devices. Figure 5 is the schematic of this device. Table 2 compares key performance parameters for the 2530 with those of a state-of-the-art feed-forward junction-isolation design (LM118) and the standard junction-isolation op amp (741).

The 2530's typical input offset voltage of 800 μ V is better than that of today's LM118-type precision amplifier, providing that in the new mixed process dc performance is not sacrificed to gain good ac performance. The figure is achieved by use of a symmetrical bipolar input stage with high β and good matching of the complementary bipolar pair.

As for the role of MOS, the n-MOS transistor (Q_{11})

DEPLETION MODE n-MOS

ENHANCEMENT MODE n-MOS

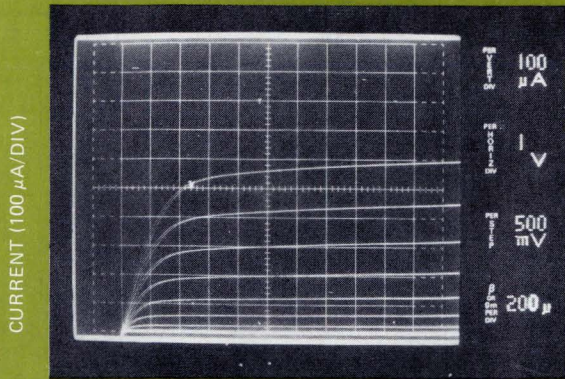

GATE-TO-SOURCE VOLTAGE, V_{GS} (0.5 V/DIV)

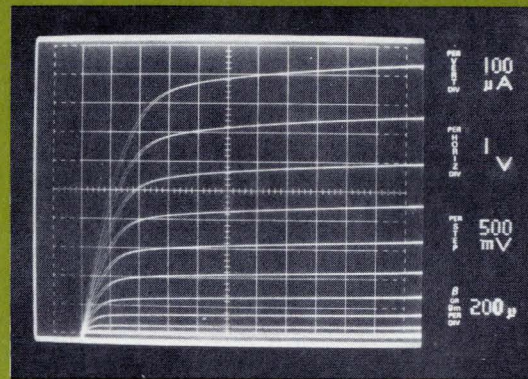

BASE-TO-EMITTER VOLTAGE, V_{BE} (0.5 V/DIV)

4. Enhancing the operation. As with digital operation, n-MOS linear devices operating in the enhancement mode (right) require lower drive voltage to conduct than do depletion-mode devices, making them better for output applications where low power is desirable.

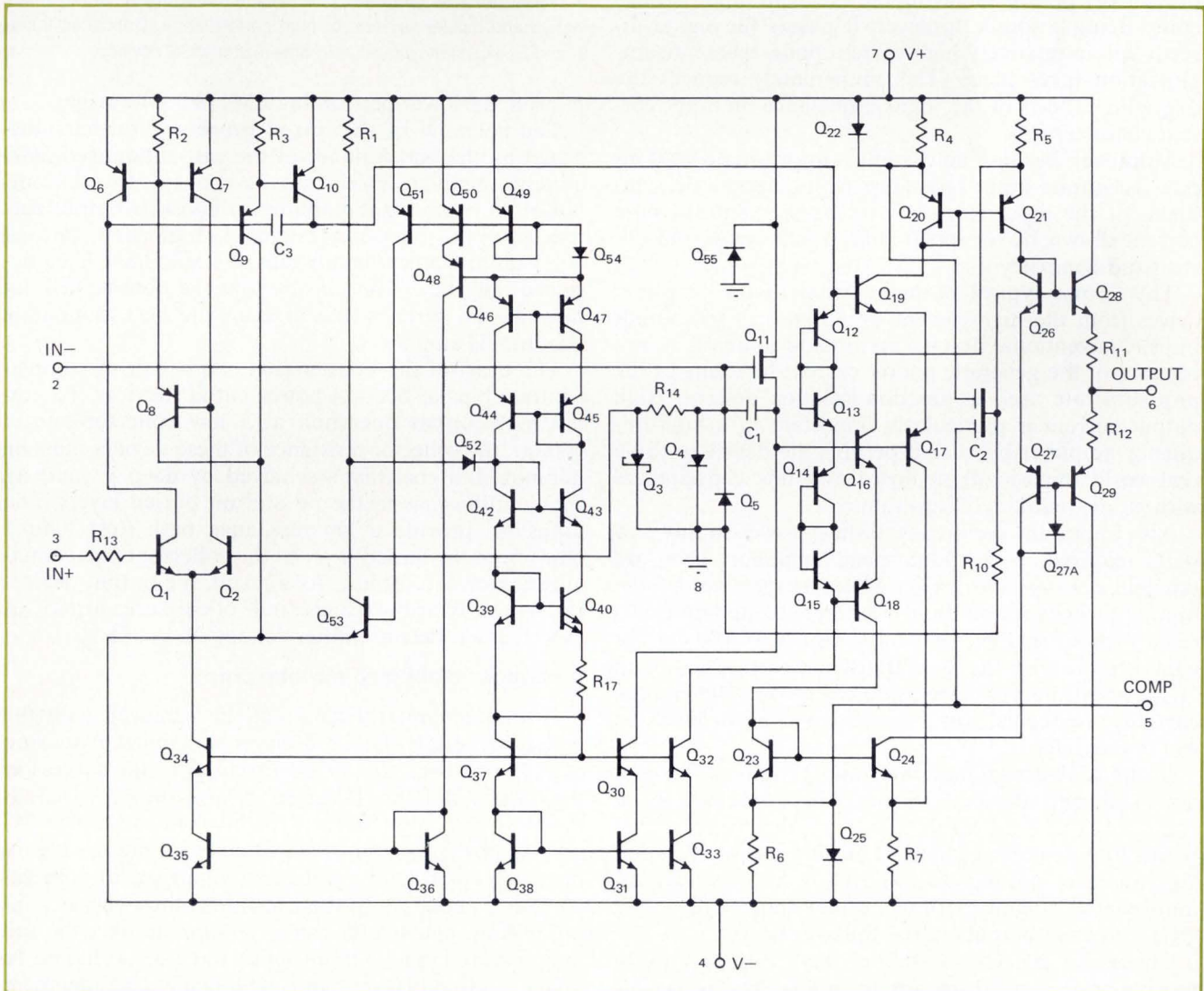

5. Widebands. The wideband operation of the 2530 is achieved with no sacrifice to dc performance—input offset voltage is only $800 \mu\text{V}$. Credit for this goes to the symmetrical bipolar input stage, with its high-beta transistors and good matching characteristics.

TABLE 2:
PERFORMANCE OF THREE WIDEBAND
INVERTING OPERATIONAL AMPLIFIERS

Device	Bipolar-MOS type (2530)	Feed-forward junction-isolation type (LM118)	Standard junction-isolation type (741)
Input offset voltage	3 mV	6 mV	6 mV
Input bias current	100 nA	500 nA	1,500 nA
Voltage gain	1×10^5 V/V	25×10^3 V/V	25×10^3 V/V
Slew rate	280 V/ μ s	50 V/ μ s (25°C) 150 V/ μ s*	0.5 V/ μ s (typ)
Small-signal bandwidth	70 MHz (typ)	15 MHz (typ) ~25 MHz*	1 MHz
Output current	25 mA	6 mA	5 mA
Supply current	6 mA	8 mA	3.3 mA
Chip size	51 x 67 mil ²	60 x 75 mil ²	57 x 57 mil ²

*In inverting application with external feed-forward capacitor.

plays a key part in achieving the excellent input parameters. Being a source follower, it passes the signal directly into a relatively high-current node, where ac amplification takes place. This immediately reduces the degrading effects of the input impedance on input current characteristics.

Moreover, because no current is drawn in an MOS input, its infinite input resistance maintains the dc symmetry of the input stage. (To point the contrast, base current drawn by a bipolar source follower would destroy the symmetry.)

The 25-mA typical output current of the amplifier drives from the high-current capabilities of the output pnps. Conventional designs are limited to about 10 mA because of the generally poorer current-handling of the pnp substrate used in junction-isolation designs. High output current is particularly important in a high-frequency amplifier because it permits the device to drive real-world (high-load) pc-board and line capacitances without degradation of slew rate.

Also important are the low (6-mA) power-supply currents required in this high-speed amplifier. They are possible because the high transfer frequencies of the bipolar devices permit them to operate at moderate currents without sacrifice of bandwidth. Also, the current gain supplied by the pnp transistor pairs Q_{20-21} and Q_{23-24} boosts output currents during slewing, when high currents are needed, yet leaves them at a low level the rest of the time.

In the 2530 design there are almost equal numbers of npn and pnp devices, because the latter are good enough not to need elimination from the critical signal paths. Pnp devices are used as current mirrors (Q_6 and Q_7), for level shifting (Q_{10} and Q_{21}), as an ac current multiplier (Q_{17} and Q_{18}), as current sources (Q_{50} and Q_{51}), and as an output emitter follower (Q_{29}).

Thanks to dielectric isolation, the 55 active and 16 passive devices of this circuit, including the 50-mA output devices and 31 picofarads of MOS capacitors are packed onto a 51 by 67 mil chip. As a measure of com-

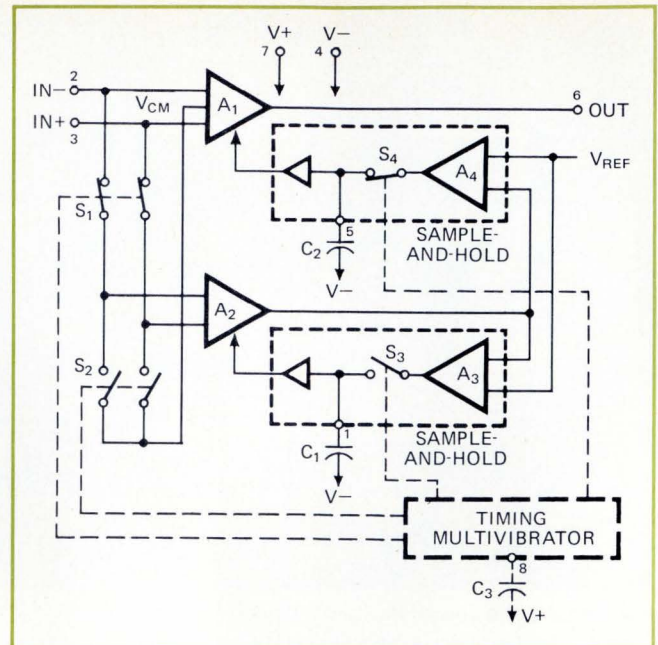

6. Mixed-process chopper. This single-chip chopper circuit mixes n-MOS and bipolar devices for high performance. Critical switches S_1 and S_2 exploit the almost zero offsets of n-MOS devices.

parison, the lower-performing LM118 is 24% larger.

The potential of the mixed process is further illustrated by the performance of the just-announced 2630 current amplifier, which may be connected to the output of an operational amplifier to boost its output current into the ± 600 -mA range. A high slew rate of 500 V/ μ s and power bandwidth of 8 MHz have been designed into the 2630 to insure that the booster will not degrade the performance of even the best monolithic operational amplifiers.

The heart of the booster circuit is a pair of complementary bipolar 600-mA power output devices. To permit high-current operation at a low collector-emitter voltage, the collector resistance of these devices must be minimized, a goal that's achieved by deep p^+ and n^+ contact diffusions to the p^0 and n^0 buried layers. The diffusions provide a low-resistance path (less than 1 ohm) from the buried layer to the collector contact metalization on the surface. As a result, the output devices can deliver typically 0.5 mA/mil² of chip area at 125°C, as well as a collector-emitter voltage, V_{CE} , of 5 V.

A chopper-stabilized op-amp chip

A final example of what can be achieved with the mixed process is the 2900 chopper-stabilized op amp [*Electronics*, Sept. 27, 1973]. Essential to the success of this circuit are the 11 linear n-MOS devices used as matched-pair input devices in the main amplifier (A_1 and A_2 in Fig. 6) and as single-ended input devices in the sample-and-hold amplifiers (connected to hold capacitors C_1 and C_2). In these locations their very low input leakage enables the circuit to operate over the full temperature range without input stage degradation. In this way, input bias current is held below 1 nanoampere at 125°C—a level of performance that even JFET inputs cannot match. □

Part 2

MODELING the bipolar transistor

Offering greater accuracy than its first-level counterpart, the second-level transistor model simulates first-order charge-storage effects and provides truer dc, ac, and transient responses

by Ian Getreu, Tektronix, Inc., Beaverton, Ore.

□ The first-level Ebers-Moll model for the bipolar transistor is essentially a simple, nonlinear dc equivalent. It does not account for charge-storage effects. To do this, at least in a first-order manner, a more complex, second-level model is needed—one that contains eight additional components requiring 12 extra parameters to describe them.

Besides accounting for charge-storage effects, which permit the realization of finite frequency and time responses, the second-level Ebers-Moll model provides a more accurate dc representation of the bipolar transistor than the first-level model. Accuracy of ac and transient responses is also improved.

Figure 1 shows the complete second-level model for an npn transistor. Three ohmic bulk resistances (r_C , r_E , and r_B), two diffusion capacitances (C_{DE} and C_{DC}), and three junction capacitances (C_{JE} , C_{JC} , and C_{SUB}) are added to the first-level model, which is simply the two diodes and the constant-current generator of the nonlinear hybrid- π model form.

Improving dc characterization

The three ohmic resistances are the additional model elements that improve the dc characterization. They represent the transistor's ohmic resistances from its active region to its collector, emitter, and base terminals.

This three-part series explains how to model the bipolar transistor systematically and how to measure the model parameters. Part 1 appeared in the Sept. 19th issue.

The internal nodes of these resistances at the active region are noted by the primed letters (C' , E' , and B') in the model diagram.

The effect of resistance r_C can be seen in Fig. 2a. Here, the collector characteristics of the second-level model (solid color lines) are compared to the collector characteristics of the first-level model (dashed color lines). Resistance r_C decreases the slope of the curves in the saturated region for low collector-emitter voltages. For the second-level model, r_C is assumed to be constant. In an actual device, however, r_C will be a function of collector current and base-collector voltage. Therefore, the biggest problem in obtaining a value for r_C is not how to measure it, but which value to use.

For most present-day transistors, the emitter region is heavily doped to achieve a high emitter injection efficiency and, therefore, a high forward current gain. Because of this, the dominant component of resistance r_E is normally the contact resistance, which is usually on the order of 1 ohm, so that r_E is often neglected. A good assumption is to regard r_E as some small constant value. The main effect of this resistance is a reduction in the voltage seen by the emitter-base junction by a factor of r_E/I_E , where I_E is the emitter terminal current¹.

Because of its influence on V_{BE} , resistance r_E is equivalent to a base resistance of $(1 + \beta_F)r_E$, where β_F is the forward current gain. Therefore, r_E affects the collector current, as well as the base current, as shown in Fig. 2b. This effect can be significant, and r_E can cause substantial errors in the determination of r_B .¹ Resist-

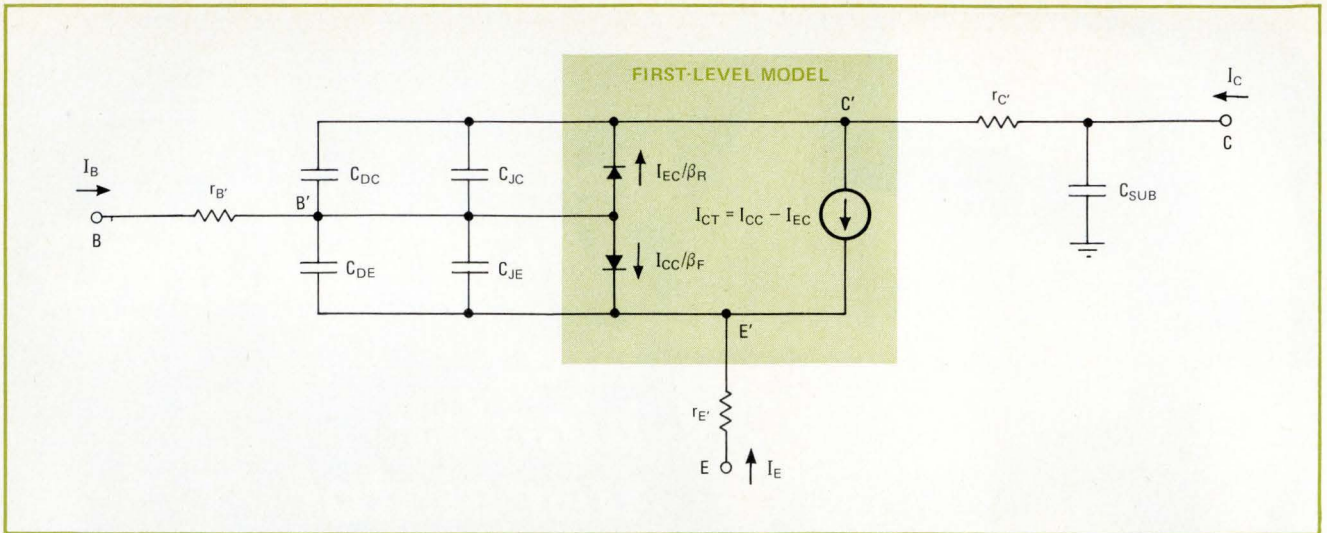

1. **The next step.** For the second-level nonlinear model of the bipolar transistor, three resistances and five capacitances are added to the first-level model, which is drawn here in its nonlinear hybrid- π form. To describe these additional elements, 12 more parameters are needed.

ance $r_{E'}$ can also seriously affect the collector characteristics in the saturation region if the transistor has a low $r_{C'}$ value.

Base resistance r_B is an important parameter. Its greatest impact is normally its effect on the small-signal and transient responses. It is also one of the most difficult parameters to measure accurately because of its strong dependence on the transistor's operating point and because of the error introduced by the small, but finite, value of $r_{E'}$. In the second-level Ebers-Moll model, resistance r_B is assumed to be constant. The effect of r_B on the collector and base currents is illustrated in Fig. 2b.

Accounting for charge storage

Charge storage in the bipolar transistor is modeled by means of three types of capacitances—two nonlinear junction capacitances, two nonlinear diffusion capacitances, and a constant substrate capacitance.

The two junction capacitances, which are sometimes called transition capacitances, model the incremental fixed charges that are stored in the transistor's space-

charge layers for incremental changes in the associated junction voltages. These capacitances are denoted by C_{JE} for the base-emitter junction and by C_{JC} for the base-collector junction. Each junction capacitance is a nonlinear function of the voltage across the junction with which it is associated.

Normally, to simplify the analysis of C_{JE} and C_{JC} , the depletion approximation is made—that is, the space-charge layer at the junction of interest is assumed to be depleted of carriers. Then, the variation of the emitter junction capacitance with the base-emitter junction voltage can be written as:²

$$C_{JE}(V_{BE'}) = C_{JE0}/[1 - (V_{BE'}/\phi_E)]^{m_E} \quad (1)$$

where C_{JE0} is the value of the emitter-base junction capacitance at $V_{BE'} = 0$, ϕ_E is the emitter-base barrier potential, and m_E is the emitter-base capacitance gradient factor. Likewise, the variation of the collector junction capacitance with the base-collector junction voltage is given by:

$$C_{JC}(V_{BC'}) = C_{JC0}/[1 - (V_{BC'}/\phi_C)]^{m_C} \quad (2)$$

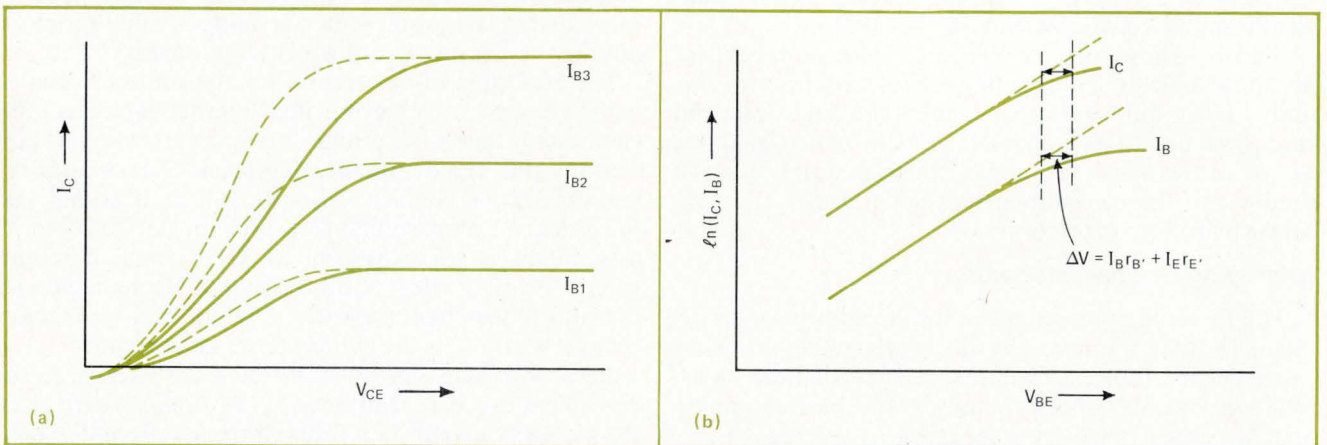

2. **What the resistances do.** Characteristic curves of the first-level model (dashed lines) are compared here with those of the second-level model (solid lines). Collector characteristics of (a) show how resistance $r_{C'}$ decreases the slope of curves in saturated region. Resistances $r_{B'}$ and $r_{E'}$, on the other hand, increase the base-emitter voltage for a given operating current, as shown in (b).

where C_{JCO} is the value of the collector-base junction capacitance at $V_{BC} = 0$, ϕ_C is the collector-base barrier potential, and m_C is the collector-base capacitance gradient factor.

These equations hold for either a step (abrupt) junction or a linear (graded) junction². For a step junction the gradient factor is 0.5; and for a linear junction, it is 0.333. Since most practical transistor junctions lie between an abrupt and a graded transition, Eqs. 1 and 2 are assumed to be general and to apply for all junctions with a gradient factor between 0.333 and 0.5.

Parameters ϕ_E and ϕ_C are the transistor's built-in barrier junction potentials (not to be confused with the transistor's energy gap, E_g). The barrier potential is the voltage drop across the junction that sets up a drift component of current to oppose the large diffusion component.² In the second-level model, the barrier potential is used only to compute its associated junction capacitance.

The functional dependencies of C_{JE} and C_{JC} are built into the second-level Ebers-Moll model. To specify each junction capacitance completely, three parameters— C_{J0} , ϕ , and m —are required. Although most experimental data can be forced to fit Eqs. 1 and 2, the reduction of the measured capacitance as a function of voltage into these three parameters is not trivial if any stray capacitances are present. Some computer programs allow the user to specify each junction capacitance at a nonzero value of its associated junction voltage, instead of requiring the C_{J0} value.

Figure 3 shows three plots of the variation of the junction capacitance as a function of junction voltage. The dashed black line, representing Eqs. 1 and 2, indicates that if the transistor is forward-biased, these equations predict an infinite capacitance when the internal junction voltage equals the built-in barrier potential. However, the depletion approximation is not valid for the forward-biased region, so that Eqs. 1 and 2 no longer apply. The solid color line in Fig. 3 shows what a more accurate non-infinite variation of junction capacitances looks like³, but this curve requires at least one extra parameter to describe it⁴.

Instead, the curve can be approximated by a straight line when the junction voltage is greater than half the barrier potential⁵. The straight-line approximation, which is drawn as a dashed color line in Fig. 3, has slope of the simple (black) curve at $\phi/2$. The equation for this straight line is:⁴

$$C_J(V) = 2^m C_{J0} [2m(V/\phi) + (1 - m)]$$

where the appropriate junction subscripts are omitted and V must be greater than or equal to $\phi/2$. This approximation is acceptable because, under forward bias, the diffusion capacitances are dominant. Furthermore, the approximation avoids the infinite capacitance value without requiring extra parameters, and it is accurate in the reverse-bias region where it is most important.

Adding the diffusion capacitances

The diffusion capacitances model the charge associated with the mobile carriers in the transistor. This charge is divided into two components: one linked with

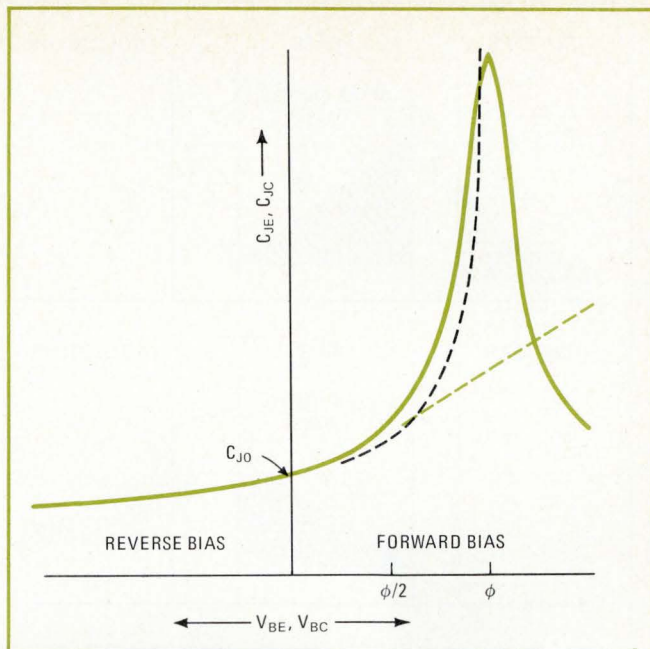

3. Junction capacitances. Emitter junction capacitance C_{JE} and collector junction capacitance C_{JC} depend on their associated junction voltages, as shown by the solid color curve. Their variation can be approximated by dashed black curve for reverse-bias conditions. However, for forward-bias, the straight-line approximation is used instead, when the junction voltage is greater than $\phi/2$.

the reference collector source current (I_{CC}) and the other linked with the reference emitter source current (I_{EC}). Each component is represented by a capacitance.

To evaluate the diffusion capacitance associated with I_{CC} , the total mobile charge associated with I_{CC} must be considered. Therefore, the base-emitter junction is assumed to be forward-biased, with $V_{BC} = 0$. Figure 4a shows the minority-carrier concentrations for the one-dimensional case of constant base doping, negligible base recombination, and low-level injection. The total mobile charge can be written as the sum of the individual minority charges:

$$Q_{DE} = Q_1 + Q_2 + Q_3 + Q_4$$

where Q_1 is the mobile minority charge stored in the neutral emitter region, Q_2 is the mobile minority charge in the emitter-base space-charge region associated with I_{CC} , Q_3 is the minority mobile charge stored in the neutral base region, and Q_4 is the mobile minority charge in the collector-base space-charge region associated with I_{CC} . Because of charge neutrality, there will be identical majority charges stored in these regions. However, to determine diffusion capacitance, only one charge (minority or majority) needs to be considered.

Charge Q_2 is normally considered to be zero, so that the total mobile charge associated with I_{CC} can be expressed as:

$$\begin{aligned} Q_{DE} &= Q_1 + Q_3 + Q_4 \\ Q_{DE} &= \tau_E I_{CC} + \tau_B I_{CC} + \tau_{CB(SCL)} I_{CC} \\ Q_{DE} &= (\tau_E + \tau_B + \tau_{CB(SCL)}) I_{CC} \\ Q_{DE} &= \tau_F I_{CC} \end{aligned}$$

where τ_E is the emitter delay, τ_B is the base transit time,

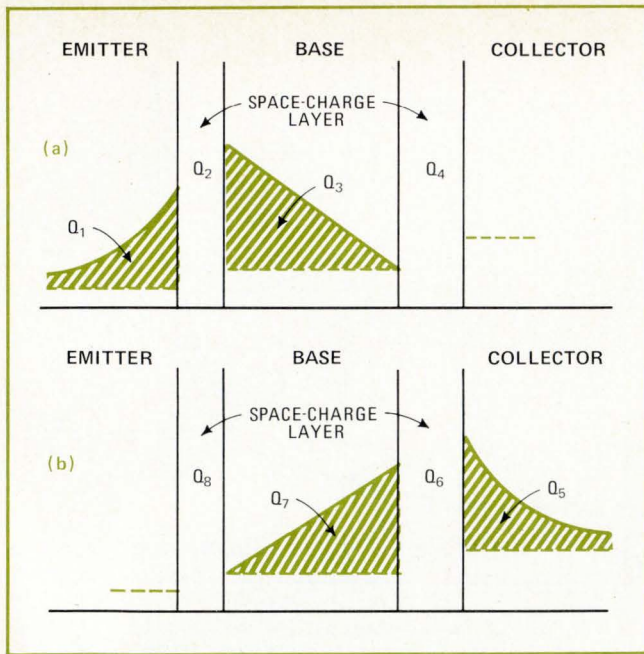

4. For the diffusion capacitances. To evaluate emitter and collector diffusion capacitances (C_{DE} and C_{DC}), the charge associated with transistor's mobile carriers is analyzed for both reference currents (I_{CC} and I_{EC}). Like junction capacitances C_{JE} and C_{JC} , the diffusion capacitances depend on their junction voltages. Diagrams (a) and (b) show charge components for C_{DE} and C_{DC} , respectively.

$\tau_{CB(SCL)}$ is the base-collector space-charge-layer transit time, and τ_F is the total forward transit time.

A similar analysis (Fig. 4b) of the total mobile charge associated with I_{EC} gives:

$$Q_{DC} = Q_5 + Q_6 + Q_7 + Q_8$$

where Q_5 is the mobile minority charge stored in the neutral collector region, Q_6 is the mobile minority charge in the collector-base space-charge region associated with I_{EC} , Q_7 is the minority mobile charge stored in the neutral base region, and Q_8 is the mobile minority charge in the emitter-base space-charge region associated with I_{EC} . If charge Q_6 is assumed to be zero, then:

$$\begin{aligned} Q_{DC} &= \tau_C I_{EC} + \tau_{BR} I_{EC} + \tau_{EB(SCL)} I_{EC} \\ Q_{DC} &= \tau_R I_{EC} \end{aligned}$$

where τ_C is the collector delay, τ_{BR} is the reverse base transit time, $\tau_{EB(SCL)}$ is the base-emitter space-charge-layer transit time, and τ_R is the total reverse transit time.

These two charges, Q_{DE} and Q_{DC} , are modeled by two nonlinear capacitances, C_{DE} and C_{DC} , respectively:

$$\begin{aligned} C_{DE} &= Q_{DE}/V_{BE'} = \tau_F I_{CC}/V_{BE'} \\ C_{DC} &= Q_{DC}/V_{BC'} = \tau_R I_{EC}/V_{BC'} \end{aligned}$$

For small-signal analyses, capacitance C_{DE} is linearized to:

$$C_{DE} = g_{mF} \tau_F$$

where g_{mF} is the transistor's forward transconductance:

$$g_{mF} = dI_{CC}/dV_{BE'} \Big|_{V_{BC'}=0} = qI_{CC}/kT$$

where q is electron charge, k is Boltzman's constant, and

T is temperature. Similarly, for small-signal analyses, capacitance C_{DC} is linearized to:

$$C_{DC} = g_{mR} \tau_R$$

where g_{mR} is the transistor's reverse transconductance:

$$g_{mR} = dI_{EC}/dV_{BC'} \Big|_{V_{BE'}=0} = qI_{EC}/kT$$

The positions of diffusion capacitances C_{DE} and C_{DC} in the model can be justified by considering the voltages that influence the charges— $V_{BE'}$ for Q_{DE} , and $V_{BC'}$ for Q_{DC} . In today's transistors, the contribution of the base-region terms, charges Q_3 and Q_7 , is not as significant as it used to be. For example, in the total forward transit time, τ_F , emitter delay τ_E can be as great as or greater than base transit time τ_B ; while in the total reverse transit time, τ_R , collector delay τ_C is invariably the dominant component.

Although transit times τ_F and τ_R are the only extra parameters needed to describe capacitances C_{DE} and C_{DC} , some computer programs⁵ enable the user to specify parameters other than τ_F and τ_R —ones that are more easily measured.

For example, the total forward transit time, τ_F , can be determined from the transistor's unity-gain crossover frequency (f_T) at a given collector current and collector-emitter voltage. From the operating point at which f_T is measured, the program will first calculate V_{BE} and V_{BC} and next compute C_{JE} and C_{JC} . Then, when base-width modulation is neglected, τ_F can be found from:⁵

$$\tau_F = (1/2\pi f_T) - (kT/qI_C)[C_{JE} + C_{JC}(1 + (qI_C/kT)rc)]$$

Similarly, the total reverse transit time, τ_R , can be determined from another parameter, τ_{SAT} , which is the saturation time constant and is related to the saturation delay time. The relationship between τ_R and τ_{SAT} is:²

$$\tau_R = \left[\frac{1 - \alpha_F a_R}{a_R} \right] \tau_{SAT} - \frac{\alpha_F \tau_F}{a_R}$$

where α_F is the forward common-base large-signal current gain, and α_R is the reverse common-base large signal current gain.

Another junction capacitance

Substrate capacitance C_{SUB} is especially important for analyzing integrated circuits. Although it is actually a junction capacitance and varies with the epitaxial-layer-substrate potential, it is modeled as a constant-value capacitance. The constant-value representation is adequate for most applications since the epitaxial-layer-substrate junction is reverse-biased for isolation purposes. (To include the variation of C_{SUB} with epitaxial-layer-substrate voltage, a separate diode or transistor is usually added to the model.)

The placement of C_{SUB} shown in the model of Fig. 1 is correct for an npn transistor. For a pnp transistor, however, C_{SUB} may not be connected to the collector. Instead, for a lateral pnp device, C_{SUB} is connected between the base and the substrate; while for a substrate pnp device, it is set to zero since it is already modeled in the C_{JC} junction capacitance.

The second-level model of Fig. 1 can be linearized as

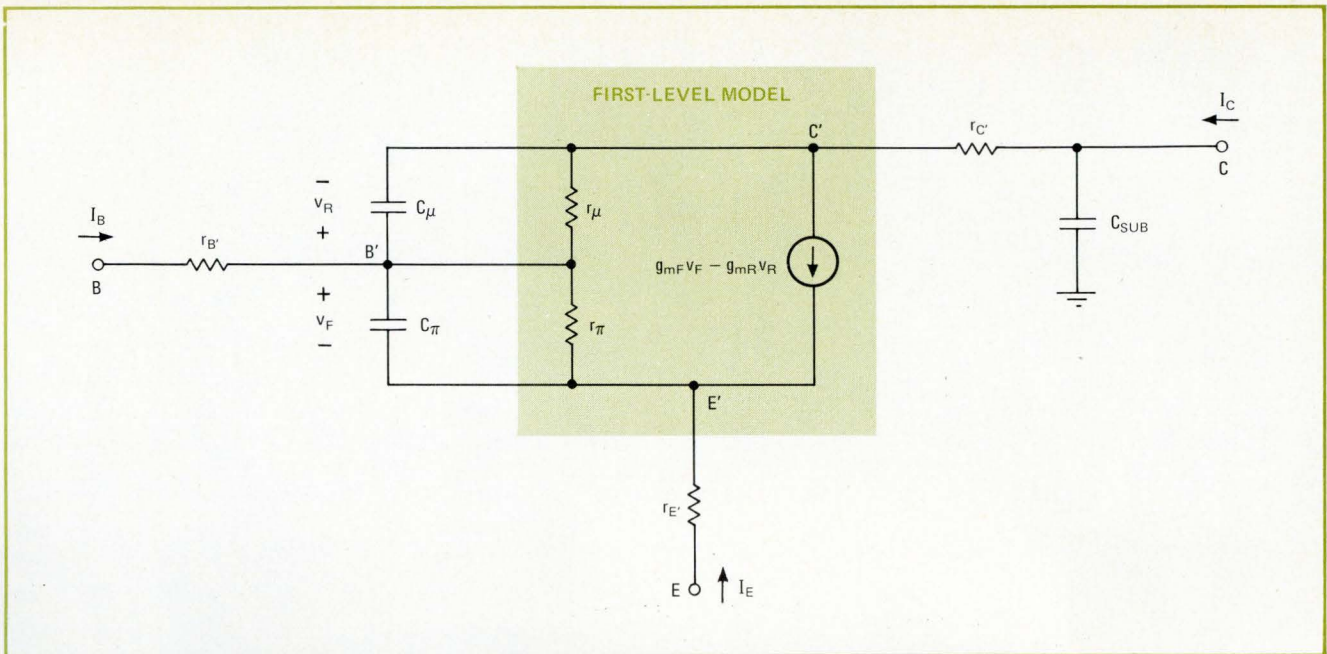

5. Second-level linear version. For linear ac analyses, second-level nonlinear model of Fig. 1 can be reduced to this linear hybrid- π form, in which six elements are added to first-level linear model. Capacitances C_π and C_μ represent linearized composites of two nonlinear junction capacitances and the two nonlinear diffusion capacitances. Ohmic resistances $r_{B'}$, $r_{C'}$, and $r_{E'}$ are assumed to be constant.

shown in Fig. 5 for performing ac linear analyses. The elements for this linear hybrid- π model are given as:

$$\begin{aligned} r_\pi &= \beta_F / g_{mF} \\ r_\mu &= \beta_R / g_{mR} \\ C_\pi &= g_{mF} \tau_F + C_{JE}(V_{B'C'}) \\ C_\mu &= g_{mR} \tau_R + C_{JC}(V_{B'C'}) \end{aligned}$$

where β_R is the inverse beta. In the normal region of operation, reverse transconductance g_{mR} is essentially zero, so that resistance r_μ can be regarded as infinite and capacitance C_μ becomes approximately equal to $C_{JC}(V_{B'C'})$.

In summary, the second-level Ebers-Moll model requires eight extra components—three constant resistances, four nonlinear capacitances, and one constant capacitance—to be added to the first-level model. The five capacitances provide a first-order accounting of the charge storage in the transistor, while the three resistances give an improved dc representation. To characterize these eight components, a total of 12 extra parameters must be measured.

The resistances are described directly:

- $r_{C'}$, the constant collector ohmic resistance,
- $r_{E'}$, the constant emitter ohmic resistance, and
- $r_{B'}$, the constant base ohmic resistance.

For emitter junction capacitance C_{JE} , three more parameters are needed:

- C_{JE0} , the emitter-base junction capacitance at $V_{B'E'} = 0$, or some C_{JE} at a given V_{BE} ,
- $\phi_{E'}$, the emitter-base barrier potential, and
- $m_{E'}$, the emitter-base capacitance gradient factor.

For collector junction capacitance C_{JC} , a similar set of three parameters is required:

- C_{JC0} , the collector-base junction capacitance at $V_{B'C'} = 0$, or some C_{JC} at a given V_{BC} ,
- $\phi_{C'}$, the collector-base barrier potential, and

- $m_{C'}$, the collector-base capacitance gradient factor. For emitter diffusion capacitance C_{DE} , only one additional parameter is required:

- τ_F , the total forward transit time, or unity-gain bandwidth f_T at a given I_C and V_{CE} .

Likewise, one other parameter is needed to determine collector diffusion capacitance C_{DC} :

- τ_R , the total reverse transit time, or saturation time constant τ_{SAT} .

And finally, substrate capacitance C_{SUB} is described directly:

- C_{SUB} , the constant capacitance between the substrate and the collector for an npn transistor or between the substrate and the base for a lateral pnp transistor.

It should be emphasized that the second-level model is adequate for the majority of cases, especially for analyzing digital circuits. However, there are still some limitations with this model. It neglects second-order effects like: base-width modulation, the variation of current gain with current level, the variation of ohmic resistances $r_{C'}$ and $r_{B'}$ with operating point, the distributed nature of $r_{B'}$ across the collector-base junction capacitance, the variation of transit time τ_F with operating point, and the variation and breakdown of all the model parameters with temperature. To account for these second-order effects, a more complex model is needed.

REFERENCES

1. W.M.C. Sansen and R.G. Meyer, "Characterization and Measurement of the Base and Emitter Resistances of Bipolar Transistors," IEEE Journal of Solid-State Circuits, Vol. SC-7, pp. 492-498, 1972.
2. P.E. Gray, D. DeWitt, A.R. Boothroyd, and J.F. Gibbons, "Physical Electronics and Circuit Models of Transistors," SEEC, Vol. 2, J. Wiley, 1964.
3. B.R. Chawla and H.K. Gummel, "Transition Region Capacitance of Diffused pn Junctions," IEEE Transactions on Electron Devices, Vol. ED-18, pp. 178-195, 1971.
4. H.C. Poon and H.K. Gummel, "Modeling of Emitter Capacitance," IEEE Proceedings (Lett.), pp. 2, 181-2, 182, December, 1969.
5. T.E. Idleman, F.S. Jenkins, W.J. McCalla, and D.O. Pederson, "SLIC: a simulator for Linear Integrated Circuits," IEEE Journal of Solid-State Circuits, Vol. SC-6, pp. 188-203, 1971.

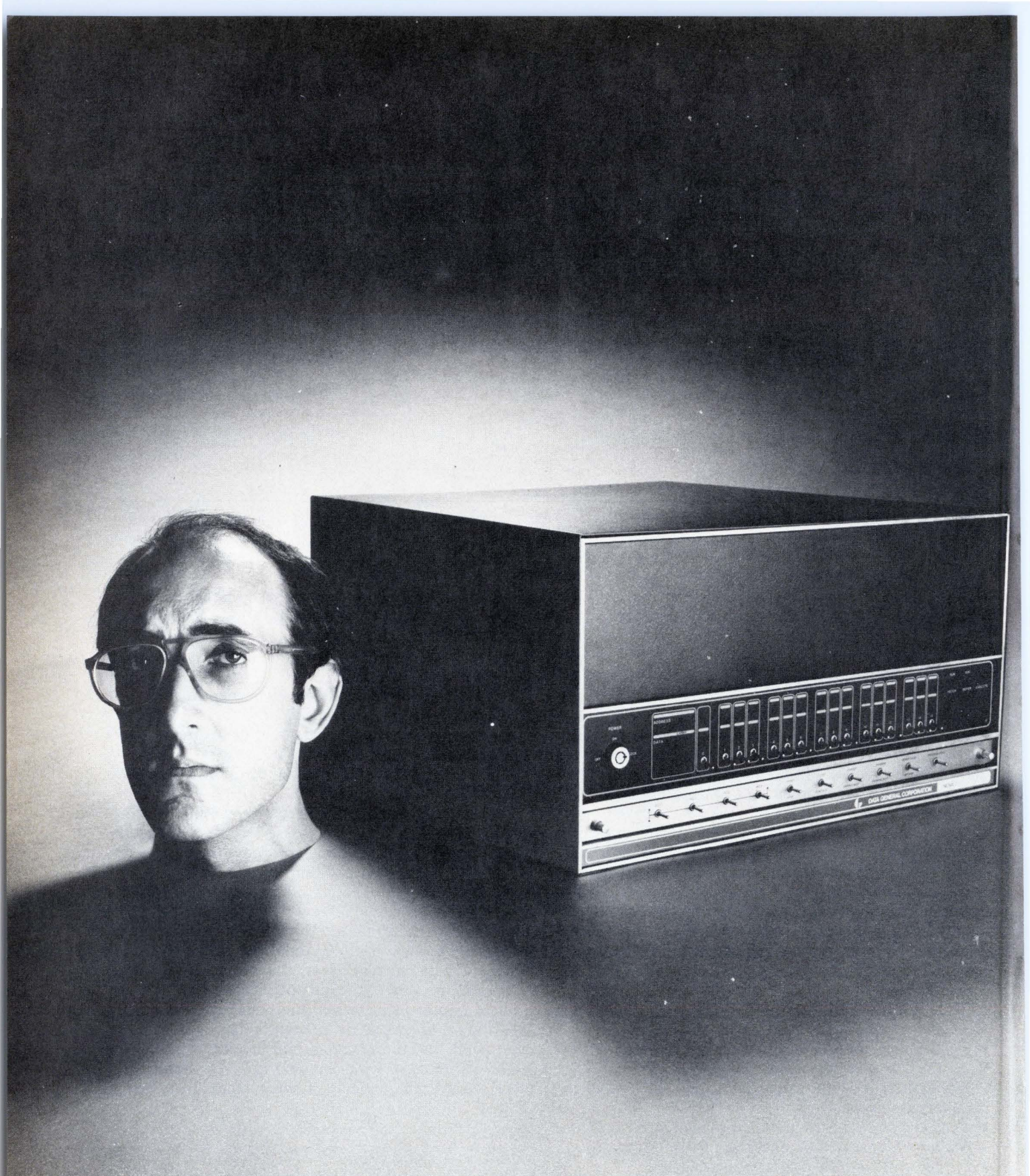

The brain on the left costs four times
as much as the brain on the right.

These days, it's costing a lot more to get a computer programmed than it does to get the computer.

So anyone with any sense of proportion is now checking out systems software as carefully as they used to check out hardware.

Which is an idea we'd like to encourage.

Because we've designed our systems software to help you get your programming done faster, easier and for less money.

Our Real-Time Disc Operating System (RDOS) does a lot of work other operating systems expect programmers to do. To create a file named "FRED," for example, all you have to do is type in "CREATE FRED." You don't have to scout around for the best place for the file, or give it an address, or make sure it won't get disturbed. RDOS does all that for you.

And unlike a lot of other operating systems, you don't have to know RDOS inside out to put it to work for you. The commands are simple, straight-forward, easy-to-remember. To run a program named "BRAIN," just type in "BRAIN" (instead of gibberish like !#AREA, 3 @ 1000, 5 @ 2000! BRAIN @ 1000 @ 2000).

As a matter of fact, RDOS is so easy to use that anyone who's ever worked in FORTRAN should be able to develop programs with it.

Write for our brochure: "Software Isn't So Hard to Understand."

You may discover you don't need a lot of brains to write your software.

DataGeneral

The computer company you can understand.

Data General Corporation, Southboro, Massachusetts 01772, (617) 485-9100.
Data General of Canada, Hull, Quebec, J8Y 3S6. Data General Europe, 116 Rue de la Tour, Paris 75016 France.
Data General Australia, Melbourne (03) 82-1361/Sydney (02) 908-1366.

Circle 77 on reader service card

Coherent phase modulation attains data rates of 100 MHz

by Roland J. Turner
General Electric Co., Space Division, King of Prussia, Pa.

Though phase-modulation schemes have till now been limited to modulation rates at video frequencies of 5 megahertz or less, a new technique permits 100- to 200-MHz data rates. The key is an ordinary step-recovery

diode that produces a three-level phase code by the simple means of varying the reflection coefficient of the transmission line.

In the modulation setup shown in the figure, the short air line is terminated with an rf diode, whose state determines the reflection coefficient of the transmission line. The state of this terminating diode is established by its drive current. A type 1N914 device is used here, but a hot-carrier or p-i-n diode could be used instead.

The step-recovery diode generates an impulse function each time the input rf sine wave passes through zero in the negative-going direction. This impulse function, which occurs at the input rf bit rate, establishes the

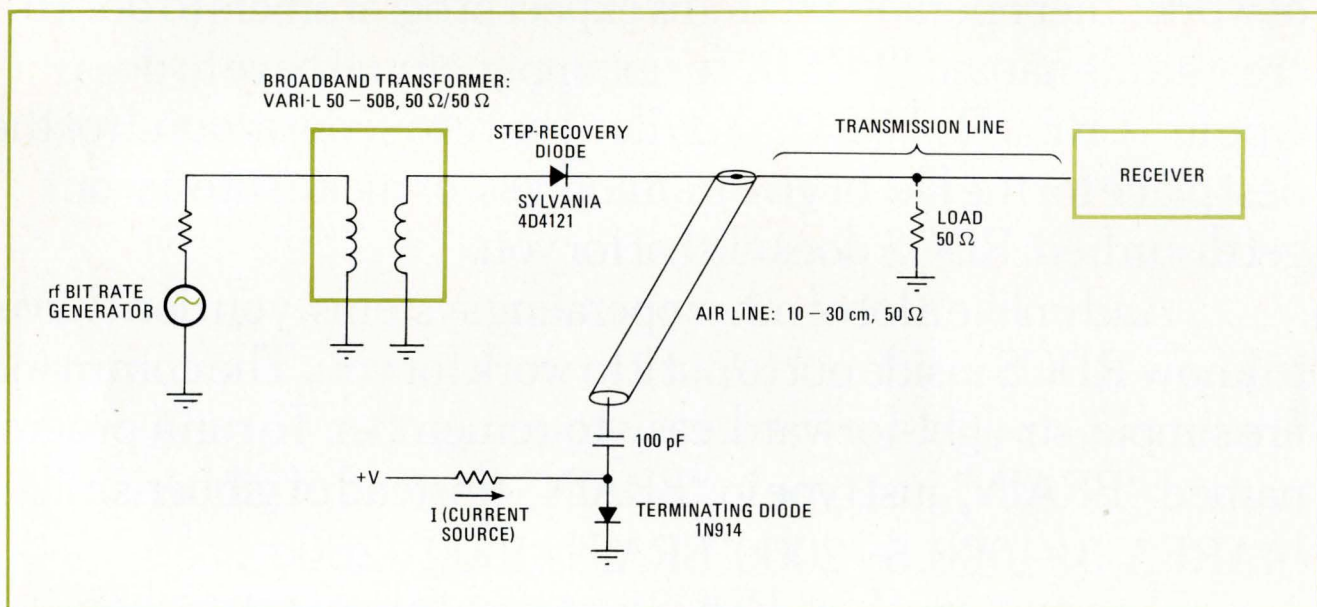

MODULATION	OUTPUT	PHASE SPECTRUM	FREQUENCY SPECTRUM
NONE (REFERENCE 0° PHASE)			
LOGIC 0 (90° PHASE SHIFT)			
LOGIC 1 (180° PHASE SHIFT)			

High-speed transmission. Data can be transmitted at rf rates of 100 to 200 megahertz with this coherent-phase-modulation scheme. A three-level phase code is set up by changing the reflection coefficient of the transmission line by means of the terminating diode at the end of the air line. The step-recovery diode acts as a waveform generator, producing impulse, doublet, and square-wave functions.

Pick your gas-discharge display and leave the driving to us

Use ITT types 504 and 505 to drive popular high voltage gas discharge displays, a job which normally requires either 90V or 180V transistors. The 504, 505 pair contains all the active circuits needed to drive a full eight segment (seven segments plus decimal) display up to ten digits wide. All segment currents are matched and programmable via a single external resistor. The 504 and 505 are supplied in high-reliability ceramic 18 pin DIPs.

Ask your ITT distributor or contact us directly for details. The 504 and 505 are available now; look for the ITT 512, now in development.

ITT...Logically

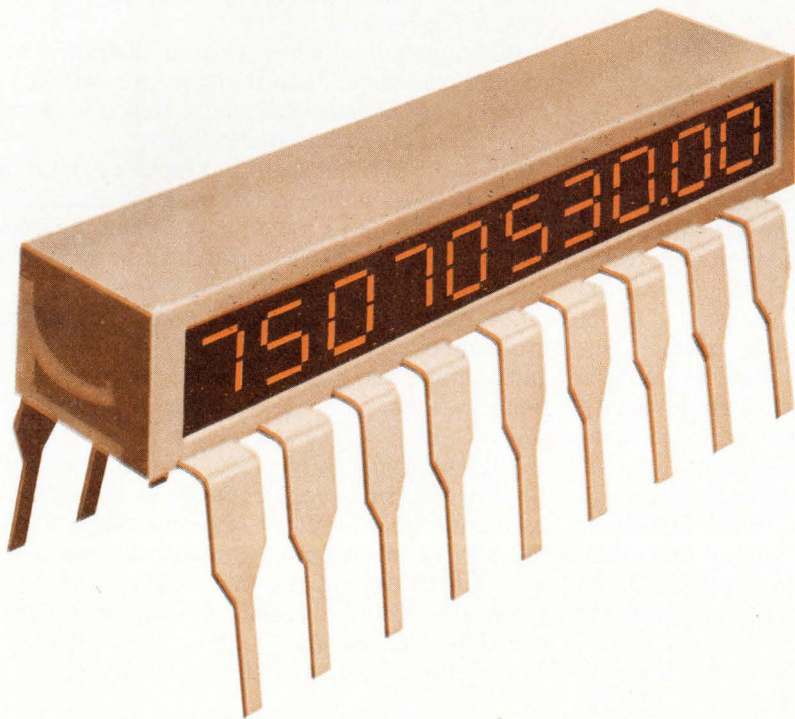

semiconductors

ITT Semiconductors is a division of International Telephone and Telegraph Corporation, 3301 Electronics Way, West Palm Beach, Florida 33407. Phone 305/842-2411. Factories in West Palm Beach, Florida • Lawrence, Massachusetts • Footscray, England • Colmar, France • Freiburg, Germany • Cascais, Portugal • Taipei, Taiwan • Sydney, Australia.

ITT

setup's reference phase (no modulation). For this case, the transmission line is terminated in its characteristic impedance, and there is no reflection. Therefore, the reference phase is represented by a 0° phase shift.

As the sine-wave drive signal reverse-biases the step-recovery diode, this device's capacitance drops radically. However, because of the minority-charge storage in the diode, the current charge is not neutralized quickly, and it forces the voltage across the diode to rise very rapidly. The result is an impulse function that lasts only 1 to 2 nanoseconds.

When there is a logic 0 at the end of the air line, this line is terminated in an impedance that's low in relation to the characteristic impedance of the transmission line. The reflection coefficient now is -1 , and a doublet waveform is produced at the step-recovery diode. The phase difference between the impulse and doublet waveforms is 90° .

When there is a logic 1 at the end of the air line, this line is terminated in a high impedance with respect to the characteristic impedance of the transmission line. The reflection coefficient becomes $+1$, and the step-recovery diode generates a double-width square wave, which is 180° out of phase with the reference impulse function.

The three waveforms form a flat comb spectrum with coherent phase modulation on all spectral lines. This means that the phase from one spectral line to the next

remains the same. The coherent phase modulation can be used to represent a three-level code in the phase domain.

The 0° phase, which is represented by the impulse function, can be used in a passive receiver to demodulate the other two discrete phases—the 90° and 180° shifts produced by the doublet and square-wave functions. These latter two phases can then represent a binary code in the phase domain that provides coherent phase modulation on all spectral lines of the comb spectrum. For an rf bit rate of 100 MHz, a spectral line will occur at multiples of 100 MHz, up to about 1 gigahertz.

With this type of phase coding, data can be transmitted at half the rf bit rate. For example, if the basic rf bit rate is 100 MHz, information can be transmitted at 50 million bits per second. Additionally, the redundant coherent reception on the many spectral lines makes the receiver immune to Johnson or man-generated noise.

The modulation scheme can also be used for a broadband rf impulse noise jammer by modulating the current of the terminating diode with white video noise. Or, it can be the basis for an rf test function generator for evaluating the transient response of communication subsystems to complex excitation.

The output amplitude of the modulation circuit is 1 volt peak into 50 ohms for the impulse and square-wave functions and 2 v, peak to peak, into 50 ohms for the doublet function. □

Single switch regulates number of pulses

by Mahesh Bhuta
IBM Corp., General Products division, San Jose, Calif.

A simple SCR ring counter or a serial-in/parallel-out shift register will make a pulse generator produce a predetermined number of pulses at the activation of a single switch. The number of pulses generated depends on which switch is closed. A pulse frequency of 100 kilohertz is easily attainable.

Circuit (a), which contains the SCR ring counter, employs a conventional astable multivibrator as its basic pulse source. Transistors Q_1 and Q_2 make up this multivibrator. When any one of the switches is closed, transistor Q_1 turns on, triggering the astable.

The astable includes an SCR so that transistor Q_2 will always saturate before transistor Q_1 . When Q_2 generates the first output pulse, the rising edge of this initial pulse fires SCR_A, enabling the astable to operate in its free-running mode. Bleeder resistor R_B provides the holding current for SCR_A.

The output from transistor Q_3 is fed to the SCR ring counter. Capacitors C, diodes D, and resistors R form the steering circuit that enables the appropriate pulse from Q_3 to fire the appropriate number of SCRs. If k

pulses are desired, the kth switch is activated, the astable will generate k pulses, and the kth pulse will fire the kth SCR, making its anode go to 0.3 volt. This immediately deprives transistor Q_1 of its base drive, and the astable is turned off.

When the kth switch is released, the power to the SCR counter is removed, and the SCRs are switched off. The counter is automatically reset so that it is ready to generate the next desired set of pulses.

The SCR counter can be replaced with a serial-in/parallel-out shift register, as shown in (b). The register's SERIAL inputs are tied high. When the switches are in their normally closed positions, the register's CLEAR input and all its outputs are low.

Transistors Q_1 and Q_2 are connected as an astable multivibrator. When any one of the switches is activated, transistor Q_1 turns on. The rising edge of the first pulse from transistor Q_2 will trigger the SCR, which will stay on because of bleeder resistor R_B .

The output pulses from the astable provide the clock signal for the shift register. Each pulse advances the register until the kth output—the one that is connected to the base of transistor Q_1 through the kth switch—goes high. Once this happens, the astable switches off. When the kth switch is released, the register's CLEAR input goes low, and the shift register is automatically reset. The next set of pulses can now be generated. □

Designer's casebook is a regular feature in Electronics. We invite readers to submit original and unpublished circuit ideas and solutions to design problems. Explain briefly but thoroughly the circuit's operating principle and purpose. We'll pay \$50 for each item published.

(a)

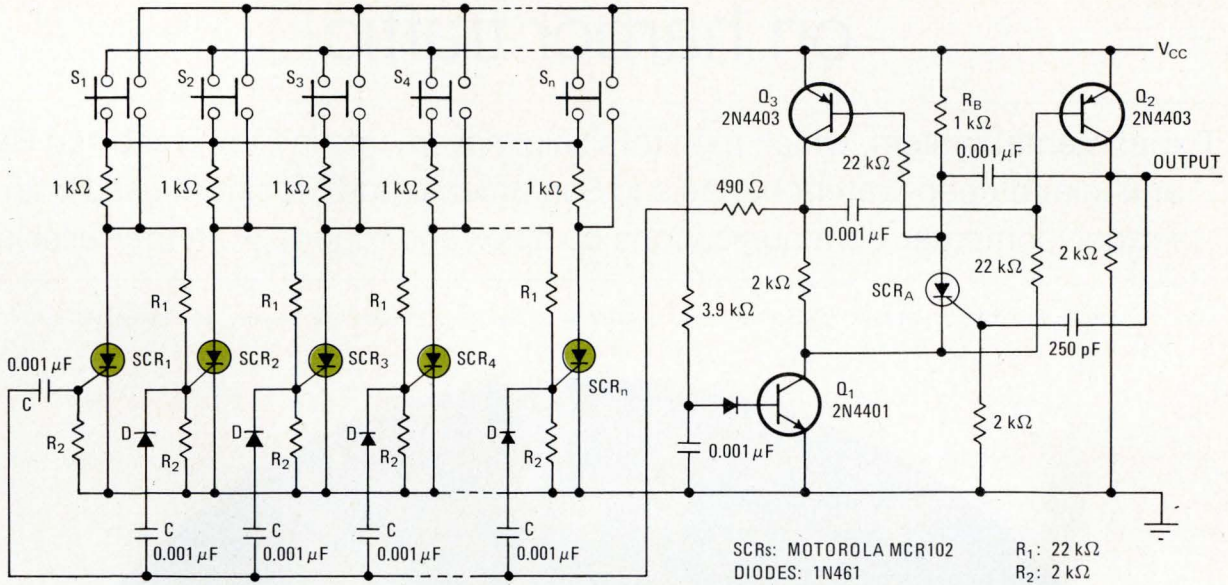

(b)

SHIFT REGISTER:
NATIONAL SEMICONDUCTOR MM74C164

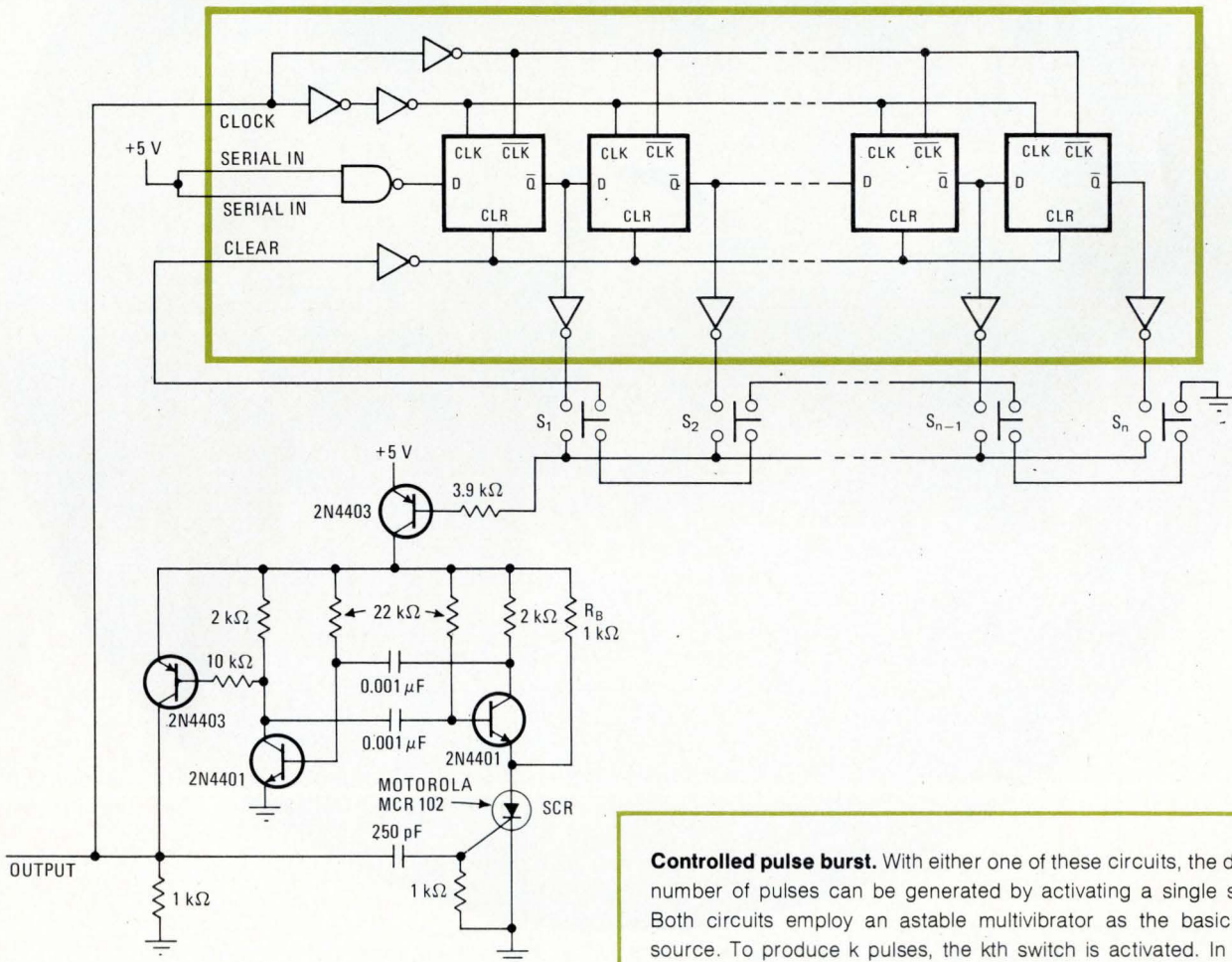

Controlled pulse burst. With either one of these circuits, the desired number of pulses can be generated by activating a single switch. Both circuits employ an astable multivibrator as the basic pulse source. To produce k pulses, the k th switch is activated. In circuit (a), an SCR ring counter is used to log the pulses, while circuit (b) uses a serial-in/parallel-out shift register instead.

Keeping a watchful eye on harbor traffic

Experimental system, which monitors ship movements in San Francisco Bay and inland deep-water channels to Sacramento and Stockton, uses both a radar-computer-communications complex and reports from the vessels

by A. J. Cote Jr. and A. C. Schultheis, *Applied Physics Laboratory, Johns Hopkins University, Silver Spring, Md.*



1. Bay area. The radar's plan-position indicator of the San Francisco Bay Vessel Traffic System shows ship tracks, as well as the undesired patterns caused by returns from irregularities in the tide-rip patterns. Parts of the area are deliberately masked out to reject returns from stationary objects.

□ World commerce is being steadily accelerated by increases in the size and speed of ships. The very improvements in size and speed that are so profitable to shippers, however, combine to boost the momentum of these ships, increasing the danger and magnitude of collisions. And when these huge ships collide near shore, massive ecological damage can result. A prime example is the 1971 collision between two tankers that spilled more than 800,000 gallons of bunker fuel near San Francisco's Golden Gate, causing extensive pollution.

The Coast Guard is trying to minimize ship damage in the area by developing the San Francisco Experimental Vessel Traffic System (VTS), an all-weather complex consisting of radar, computers, and communications that will advise mariners of traffic conditions and warn them of danger. The system, now being checked out during off hours, uses real-time automatic data processing to develop, analyze, and display information on ship traffic.

Because the San Francisco Deep Draft Waterway System encompasses a large geographical area—San Francisco bay, plus inland deep-water channels to Sacramento and Stockton—the Coast Guard maintains surveillance by two complementary methods: radar and voluntary vessel-movement reports.

Radar covers the San Francisco Bay and Pacific approach, but the Coast Guard must rely on vessel movement reports for the inland regions and as far south as Redwood City. Vessels passing designated sites in that region report to the control center and receive information on traffic conditions.

One of the system's two 50-kilowatt X-band radars sweeps 15 miles seaward from Point Bonita, a peninsula on the northern shore of the Golden Gate entrance to San Francisco Bay. The second radar covers about nine miles around Yerba Buena Island, which links two sections of the Bay Bridge between San Francisco and Oakland. The Point Bonita radar is controlled and monitored from Yerba Buena, site of the Coast Guard's main control center, by use of a microwave link. The signal sent back to Yerba Buena is a composite of video, trigger, and bearing data.

Keeping track of ships

Six very-high-frequency channels are available for ship-to-shore communications, and all voice communications are automatically recorded on audio-tape units. Specific traffic situations, as viewed by the radar, can also be documented by wideband recording on a videotape recorder. When the system is operated in the manual mode, contacts in the radar region are detected and tracked visually by operations personnel stationed at the radar console, which has five PPI (plan-position indicator) displays (see Fig. 1).

In the manual mode, the operator enters characteristics of individual ships such as name, pilot identification, and destination, on separate cards, which he mentally correlates with specific returns on his PPI. For ships in the area, operators use cards and manually update the status boards.

When operation is automatic, the operators move from the radar console to the traffic console, which has

two identical operator stations near the supervisory console (Fig. 2). Each operator station has a data-entry position equipped with keyboard, trackball, and function keys, two vessel-status displays that list those identified ships being tracked, and five situation displays.

One of the five cathode-ray-tube displays is designated the working display, and the others operate as satellite displays. Each situation display presents a computer-generated map of one of seven portions of the coverage area, and the working display (Fig. 3) is augmented by text material.

The supervisory traffic console also includes two PPI displays and monitor/control panels for the radar and communications equipment. The supervisory console is similar to an operator station, except that it has no satellite displays. It can be used independently or, alternatively, can be switched to monitor either of the working displays at the traffic console.

Working displays are interactive keyboard-coupled terminals presenting both text and graphics. Each working display and its keyboard is supported by an 8,000-word Imlac PDS-1 display computer, which refreshes the image and manages the interface between the operator and the traffic computer. The working display is partitioned into six areas:

- Operator instructions, which are prompting cues that tell the operator what action is expected of him at that point in his activities.
- Page name, which identifies the particular activity being displayed.
- Information to operator, such as the results of an analysis.
- Alert message, which turns on when a conflict or other event worthy of an operator's attention occurs, sounding a tone at the station.
- Main body, the largest partition, which contains either a map or a tabular arrangement of text to guide the operator in the entry of certain data into the system.
- Function-button labels, which are six subportions aligned with push buttons in the keyboard area just below the display (three right-hand labels impart a different meaning to their keys, depending on which page is currently on display.)

Time of day is also presented on the display, along with the last time the image was updated.

Updating traffic-situation maps

The computer-animated traffic-situation maps delineate traffic-lane boundaries, along with approximate shore lines, bridges, and key piers. Ship traffic developed by both ADT (automatic detection and tracking) systems is automatically displayed and updated every three seconds. Different symbols depict unidentified and identified ships in three sizes. Distinct symbols indicate whether each buoy is not in track, in track and on station, or in track but adrift.

Leader lines extend from each ship symbol to indicate projected future positions. On satellite displays, these look-aheads cover one minute, but the operator can vary the period of the projections on the working display to zero, one, two, three, or six minutes ahead.

Each map can display a maximum of 30 identified

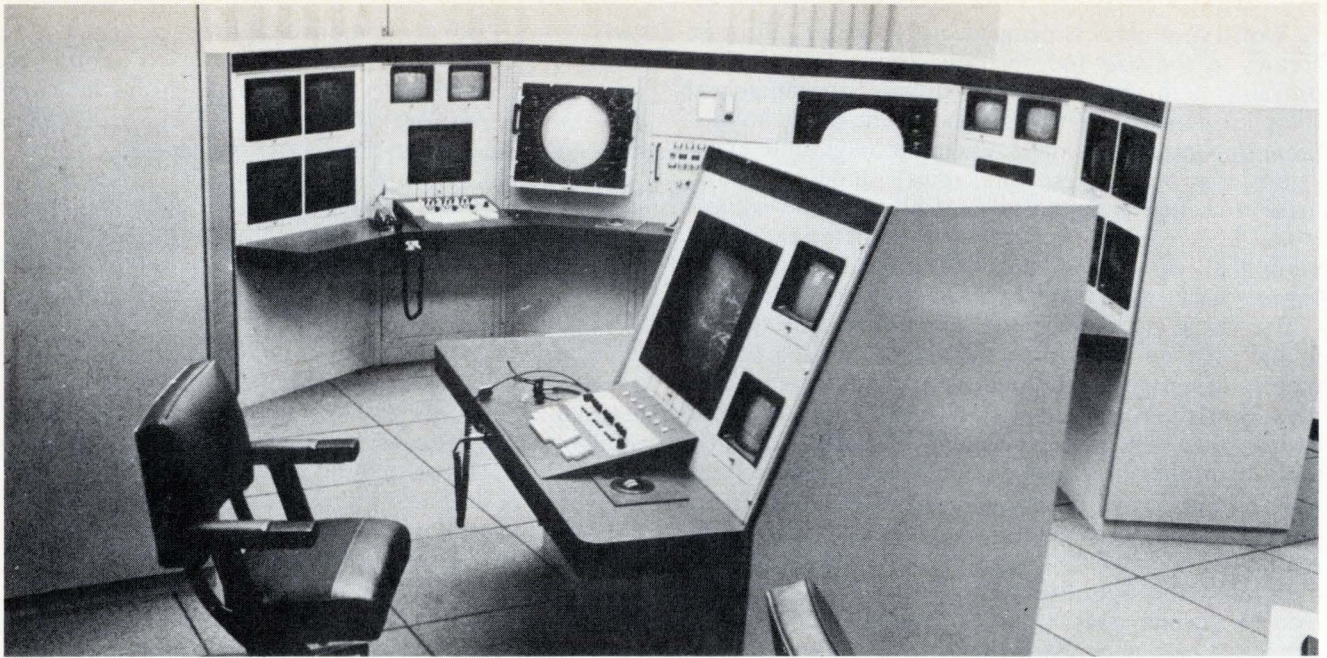

2. Control center. The Vessel Traffic System is controlled from traffic console (background) and a supervisor's console (foreground) on Yerba Buena Island. The traffic console has two identical operator stations, while the supervisor's console has only important displays.

contacts, including buoys as well as ships. In addition, a maximum of 128 buoys and unidentified ships may also be displayed in any combination. Large and medium contacts receive display priority. Identification tags may be displayed by identified ships at the operator's option. These tags follow the symbols automatically as ships pass through radar-coverage boundaries.

Each radar has its own automatic detection system, which translates the signals received from its radar into concise characterizations of the traffic within the coverage area. The traffic-analysis and display (TAD) system then integrates the information from both ADT systems and presents it in meaningful form.

The TAD also helps operators evaluate the traffic, permits them to augment surveillance data with ship descriptions, and alerts them automatically to certain types of problems. A block diagram of the automatic system is shown in Fig. 4. Signals from the two radar points are first processed in the recovery unit and then are processed further in the radar video preprocessor (RVP).

Two computer systems are used: the radar computer calculates positions and velocities, and the traffic and display computers analyze traffic and set up the displays for the operators.

The radar video preprocessor contains more than 1,500 semiconductor chips, about 45% of which are at the medium-scale level of integration. The radar computers are Honeywell DDP-516s with 8,000-word memories, hardware multiplication, and two direct-memory-access channels. To confine processing to only a portion of the coverage area of each radar and avoid processing returns from land, shallow water areas, and the bridge, a video-acceptance mask is created by gating the electronics within the RVP.

Two areas of overlapping coverage permit one system to track in an area where terrain obstructions create ra-

dar-shadow zones in the other system's normal coverage area. Within the acceptance mask, acquisition of vessel tracks is completely automatic. However, targets are not acquired within these radar-shadow zones after the total traffic population exceeds the radar computer's tracking file capacity of 253 contacts or when the ADT's system can not handle the combination of data on cross-section, automatic-detection, and tracking threshold.

Overcoming obstacles to tracking

Significant radar shadow zones exist in several parts of the coverage region (see Fig. 1). Some tracks will "coast" through these shadows, picking the vessel up on the other side, if it is large or moving fast enough. Since the radar computer tests for scan-to-scan correlation before designating a track as new, uniformly distributed clutter seldom causes a false contact. If a contact reappears on the third scan, it becomes tentative and reaches firm status only after a total of seven hits is accumulated. However, when a hit is missed, the count is decremented so that more than seven scans may be required to reach that level.

Three sources of essentially stationary anomalous returns sometimes survive these tests. At Yerba Buena, side-lobe returns from the nearby Bay bridge piers cause false tracks. They can be rejected by inhibiting acquisition within an appropriate range-bearing window, but operators have observed that if a valid ship track moves through such regions, the gate may be captured by the sidelobe return.

Second-time-around returns—returns from distant targets that are sensed during a subsequent scan—occasionally also contribute tentative images that can be upgraded to firm tracks, particularly in a region south-southeast of Yerba Buena. The tide-rip clutter patterns that frequently appear within the bay and off Point Bonita are another source of false tracking, and the ADT

system sometimes acquires and tracks them. On the PPI, they appear as irregular line-like patterns, which slowly move and change size and shape. The tracking gate, however may lock onto different parts of the line and slither erratically along it from scan to scan.

The magnitudes of tracking errors associated with false tracks are not uniform, and apparent velocities are very large. The radar-computer logic discounts these exaggerated characteristics to minimize the number of such tracks, but some still occasionally survive and reach firm status. Images of ships passing through these patterns are occasionally captured, then wander off and disappear, while the system once again goes through the cycle of acquiring the ship and counting hits for verification to get back into firm track. But after a ship has been identified, the operator is automatically alerted when it disappears after capture, and he can reestablish the correlation to the new track.

While these anomalies sometimes contribute false contacts to the traffic and supervisory-console displays, they are not as misleading as might first appear. The association of ship information with a track (carried out by the operator using the TAD system) requires the operator to select the symbol corresponding to a particular ship. Because the symbols first appear at known locations, the anomalous tracks do not cause confusion to the operator, who is effectively acting to confirm the performance of the ADT's acquisition process. Identified ships are the prime target, and the anomalous tracks appear much like the many small unidentified craft that show primarily as background distractions.

Handling the tough tracks

Several situations that occur in the course of normal traffic flow require special processing, carried out either entirely within one of the radar computers or jointly by the radar and traffic computers. When two vessels pass close together, track identities could be switched, but this would cause subsequent problems in the TAD sys-

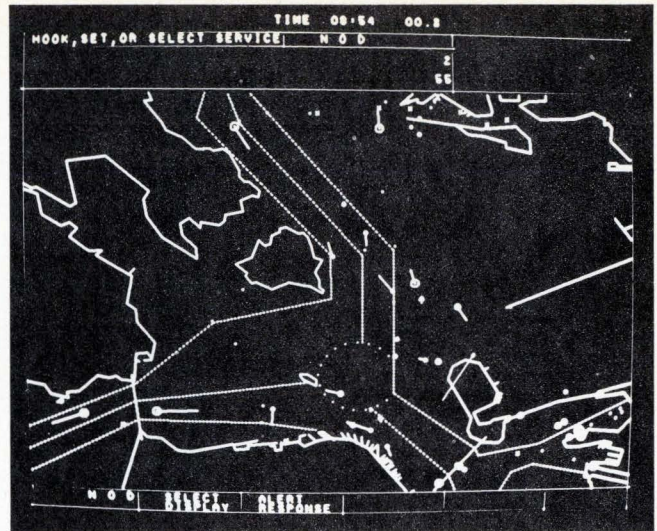

3. Working display. The system's traffic computer sets up a synthetic map display of the Bay area showing buoy locations and ship tracks. Leaders indicate the likely future courses of the vessels. Ship traffic is automatically updated every 3 seconds.

tem. The computer program, however, is written to minimize this possibility and also minimize the development of multiple tracks resulting from detection of wakes and tide rips.

Three bridges within the ADT coverage area interrupt tracking. Since returns are not available as vessels pass under bridges, extended coastal zones are defined, and special handling ensures that tracking is maintained. The logic that accomplishes this, however, was designed under the assumption that a vessel moving under a bridge emerges on the other side. It therefore failed to cope with the tour boat that executes U-turns under the Golden Gate Bridge. However, vessels on more reasonable courses are tracked successfully.

When a ship passes from the coverage zone of one radar to that of the other, logic in the traffic computer ac-

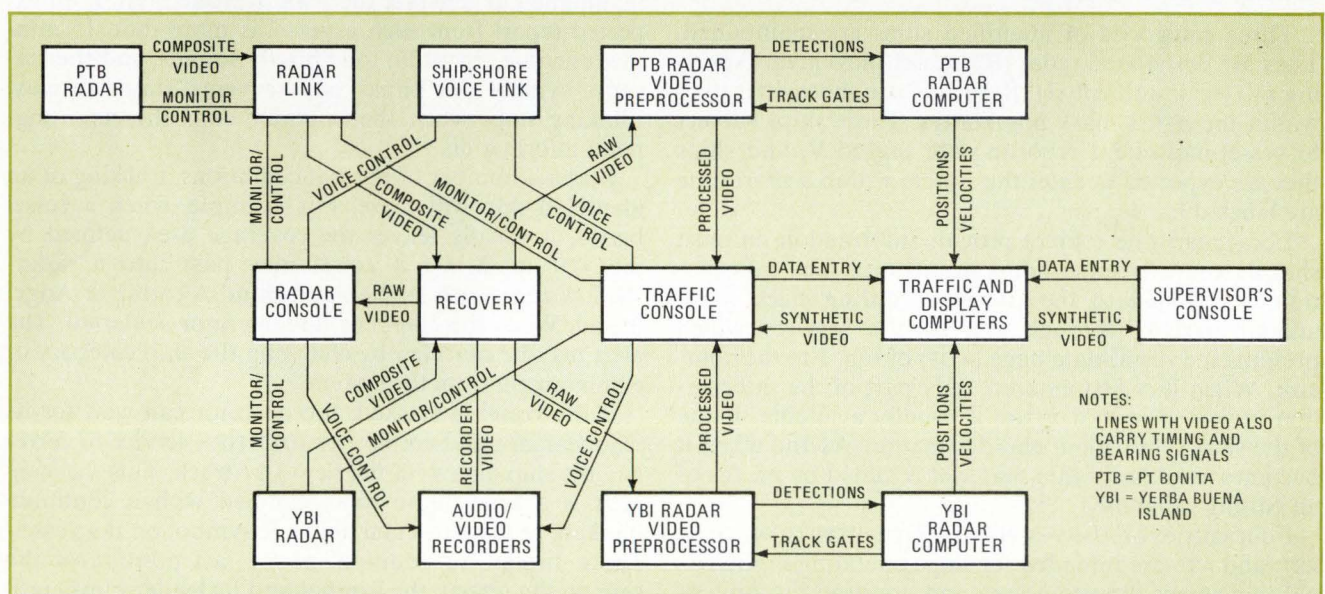

4. Over-all system. The two radars, at Point Bonita and Yerba Buena Island, feed their data to the control center, where computers analyze the data and set up the displays. Voice communications to the ships is carried on very-high-frequency radio links.

5. Vessel data. The computer-generated display of the vessel-data page lists characteristics of a single ship. Information can be added during slack periods, and operators can query the computer for information on a vessel when necessary. They edit the display as the information changes.

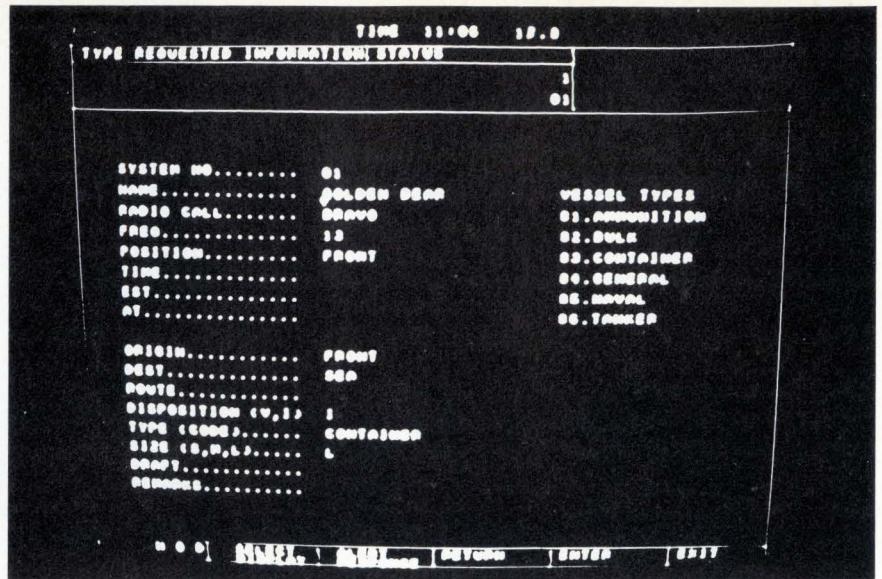

completes the hand-off automatically so that the operators are not aware of the transition. This transfer is executed when targets are west of the Golden Gate or west of Treasure Island (which lies directly north of Yerba Buena Island). The ADT system tags targets moving in these overlap areas to aid the traffic computer in this processing.

Certain buoys within the acceptance masks of the ADT system are also subject to special treatment (68 buoys are monitored by Yerba Buena and 18 by Point Bonita). If the tracked position exceeds a prespecified distance from the desired location, the traffic computer is advised, and it flashes a buoy-adrift warning. All of this ADT activity results in the transfer of an eight-word record containing size, position in polar coordinates, and speed information to the traffic computer, once every three seconds (the antenna's scan period).

Tracking identified ships

Three categories of identified ships are maintained. They are designated radar (R), vessel-movement reporting (V), or imminent (I). R vessels are those operating within the ADT's mask boundaries. Those ships subject to vessel-movement reporting are tagged V, and ships that are expected to enter the system within a short time are labeled I.

Local maritime sources provide information on most ship movements some hours in advance. The information is supplied to the computer during slack operational periods through the ENTER service, which presents the vessel-data page (VDP) of Fig. 5 to the operator. When it is first entered, only part of the information indicated in that figure is usually available: name of the ship, type, origin and destination. As and when it becomes available, other material is added by means of an editing capability.

Four entries on the vessel-data page—POSITION, TIME, EST, and AT—are intended for ships operating in the visual-movement reporting area and are used by some of the traffic-analysis and display programs if the operator has designated them V on the disposition line. Position

and time refer to a vessel's last reporting point. The last two labels (EST and AT) indicate the vessel's next reporting point and the time due.

Certain aspects of vessel status are monitored by the computers to detect danger and warn the operator of events worthy of attention. One of these alerts is a warning of imminent collision. The computer periodically makes closest-point-of-approach calculations between each identified contact and all other identified or large and medium unidentified contacts.

When the projected distance is less than 1,000 feet within five minutes, an audio tone alerts the operator, and information appears within the alert message partition on the working displays. Activating the "alert-response" function button presents the critical situation to the operator, and his current map is updated when necessary.

Status of ships in the visually monitored region is maintained to generate the VMR overdue alert. If an expected report from such a vessel is more than 15 minutes overdue, an audio tone briefly sounds, and the category symbol (V) blinks on the vessel-status display. Blinking stops when the operator edits the reporting-point information.

Under a number of normal conditions, tracking of an identified ship will cease. For example, when a vessel berths, it usually leaves the coverage area defined by the ADT mask. Or a vessel may pass into a radar-shadow zone, such as the one behind Alcatraz or Angel Island. When this happens, the operator is alerted. The alert may be canceled by changing the ship category or eliminating it from the system.

If the vessel is masked, the operator can wait for its reappearance and employ an IDENTIFY service to correlate the ship data with the new ADT track. This masking alert is a brief audio tone, coupled with a continual blinking of the particular ship's R symbol on the vessel-status display. In addition, at the last position of the ship on the screen, the symbol and its leader blink until the data is either correlated with another track or until its category is changed. □

Thermal characteristics of ICs gain in importance

Consideration of several factors offers ways to enhance reliability; one testing method is preferred when high accuracy is uppermost concern

by Robert Bolvin, Signetics Corp., Sunnyvale, Calif. *

□ All-out thermal analysis of an electronic design is usually reserved for the most sophisticated, expensive systems, and for systems that must operate in unusual environments. These days, however, as electronic packaging becomes more dense, as greater numbers of heat-producing active elements are placed on a single chip, as more ICs are mounted on a single board, designers must be increasingly concerned with the thermal aspects of systems.

Thermal resistance, therefore, is one parameter becoming more important in specifying packaging

products. It is a measure of how effectively heat is dissipated from sensitive areas; the lower the figure the better. In emitter-coupled logic devices, for example, reference bias supply voltages are set internally by a diode-resistor network that is affected to a great degree by heating. If device power dissipation and package thermal resistance at operating conditions are known, the final junction temperature on the chip can be determined, making possible the correct design of the bias network.

A half-dozen factors can be considered in arriving at the thermal resistance of an IC:

- Die size. The larger the die size the more heat sinking

*Mr. Bolvin is presently with Monolithic Memories Inc., Sunnyvale, Calif.

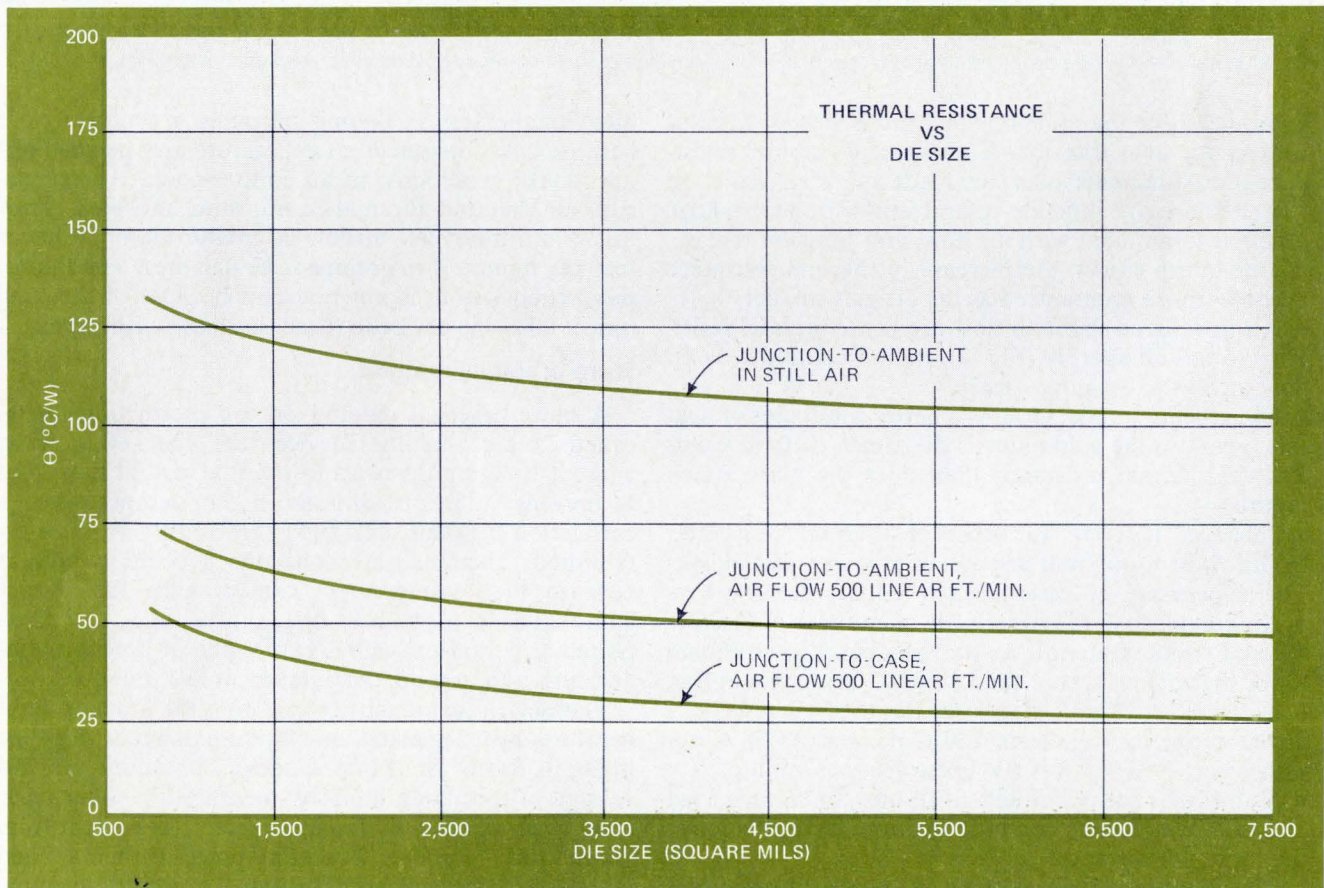

1. Chip size counts. The thermal resistance of an integrated circuit drops as die size increases. Data plotted here is for a 16-pin ceramic dual in-line package with gold die attach and Alloy 42 frame, at 25°C ambient or bath temperature.

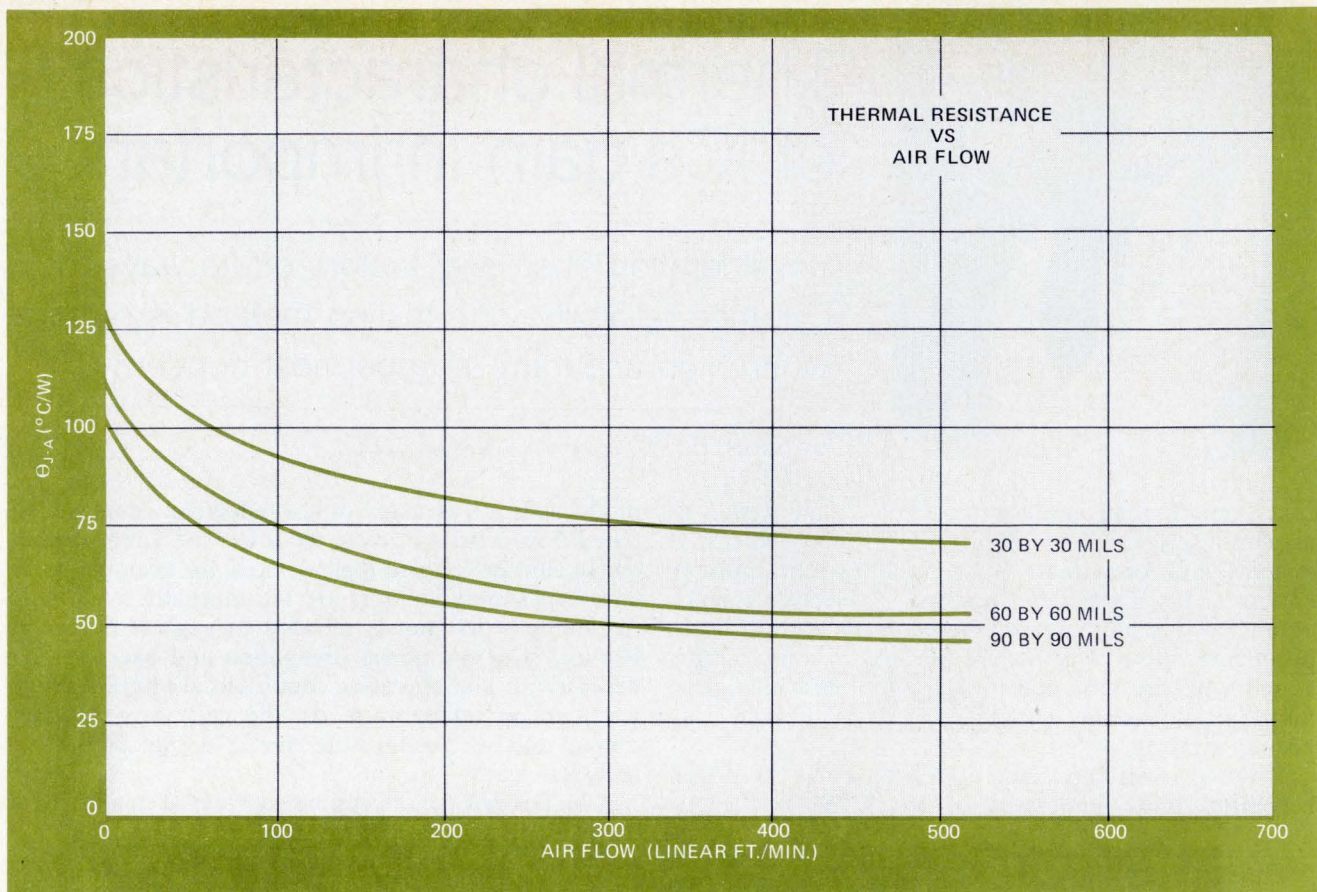

2. Air flow dependence. Thermal resistance also drops off with increasing air flow. Most noticeable when airflow is small, the effect is less pronounced when air flow becomes larger. θ_{J-A} is plotted for three die sizes with power dissipation of 215 mW and an ambient of 25°C.

is provided for the junctions and the larger the area of contact for heat transfer. A number of thermal resistance measurements may be made on a package; in Fig. 1, these are junction-to-ambient without air flow, junction-to-ambient with air flow, and junction-to-case. As the graph shows, the increase in thermal resistance becomes more pronounced as the die gets smaller.

- Air flow. Even slight air flow can cause thermal resistance to fall off sharply (Fig. 2). Falloff continues as air flow increases, but not as sharply.
- Die attach method. Gold is a better conductor of heat than glass, so the gold eutectic die attach method yields a lower thermal resistance than does the glass attach method.
- Package material. In order of thermal resistance, from lowest to highest, are ceramic, epoxy and plastic. The superiority of ceramic over epoxy, moreover, is much greater than the superiority of epoxy over plastic.
- Lead frame material. As an example, nickel affords lower thermal resistance than alloy 42. As shown in Fig. 3, a nickel lead frame decreases the thermal resistance of the epoxy package from 120°C per watt to 88°C per watt when the air flow is 500 linear feet per minute.
- Number of leads bonded to frame. Since each lead acts as a heat sinking conduit, the more leads, the lower the thermal resistance.

Considerations such as these are practical because a device designer must see to it that maximum junction temperatures will not be exceeded at anticipated am-

ambient temperatures. Testing becomes a problem here because limits on junction temperature are specified under "soak" conditions; in an emitter-coupled logic circuit, for example, thermal equilibrium has been established and transverse airflow of greater than 500 linear feet per minute is maintained. Under these conditions, production testing is not practical because of the long time it takes the device to reach thermal equilibrium.

More practical method

A more practical method on the production line is called "rapid" testing. Devices are checked quickly, without bringing them up to thermal equilibrium. But to prevent failures at untested higher temperatures, a correlation between soak and rapid testing must be established. Thermal time constants become important because the manufacturer can provide the proper guardbands if he knows, first, the changes to be expected in parameter values per degree of junction temperature, and, second, the equipment test time.

The device manufacturer can monitor junction temperatures by using actual on-chip functional devices like isolation diodes or clamp diodes. The initial forward voltage of the diode must be measured, *without operating power applied*, by forcing a fixed test current from ground to V_{CC} or V_{EE} . Operating power is then applied to establish thermal equilibrium. To record the final value of the diode voltage, operating power must then be removed and the fixed current applied once more.

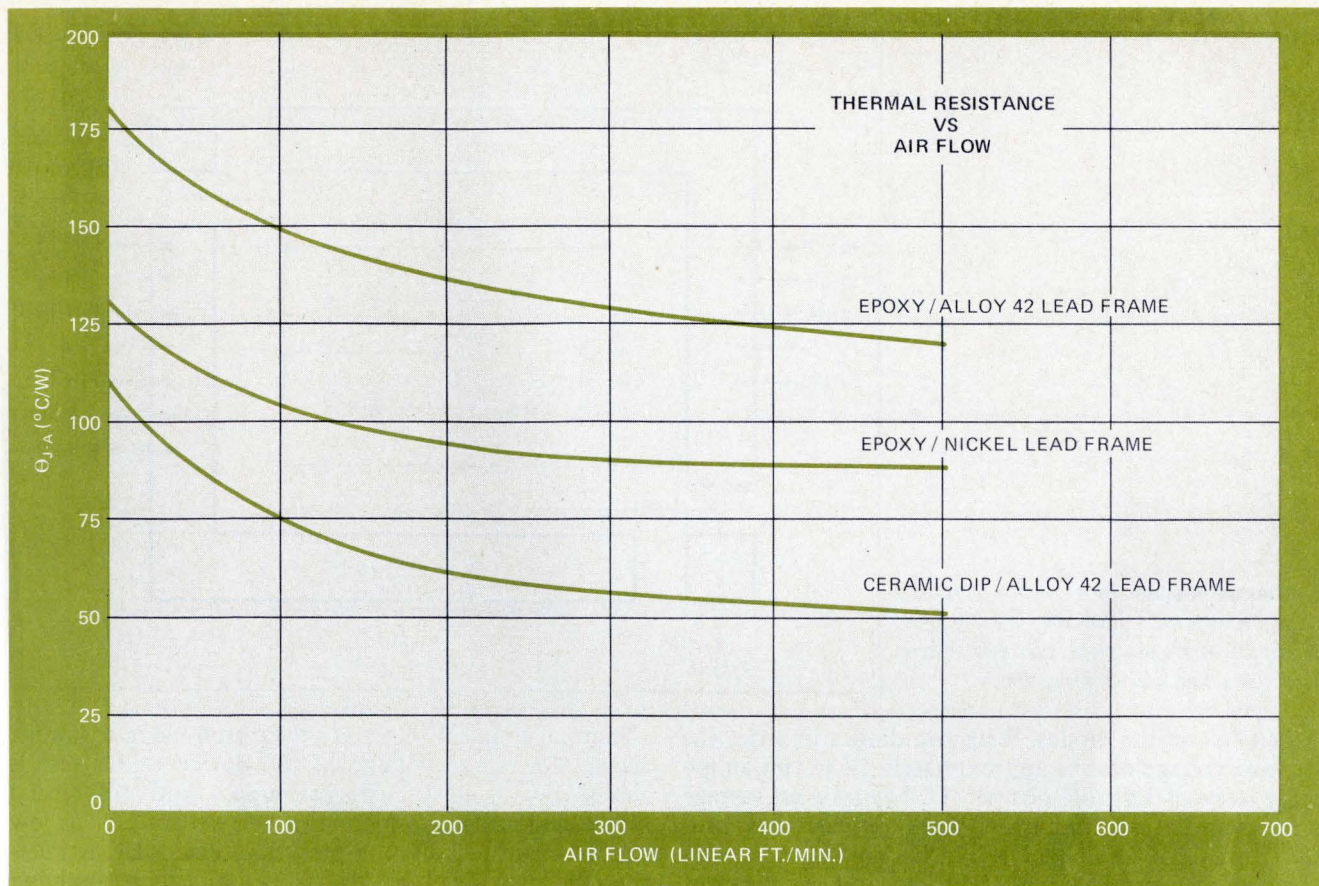

3. Package effects. Thermal designers must consider that different packages and lead frames have different thermal resistances even for the same die. Data here applies to a 60-by-60-mil chip dissipating 215 milliwatts. Ambient temperature is 25°C.

Calculation of thermal resistance (Θ), with this method is as follows:

$$T_J \text{ rise} = V_{FF} - V_{FI} / \text{slope}$$

$$\Theta = T_J \text{ rise} / PD$$

Where V_{FI} is the initial forward diode voltage at zero power, V_{FF} is the final forward diode voltage after thermal equilibrium (in volts), T_J is the junction temperature, PD is the power dissipation (in watts), and slope is the change in voltage due to change in temperature (in millivolts per °C).

Time span critical

The time span between the point when the power is turned off and the point when a final diode voltage is measured is critical. Switching from power on to power off and making a final measurement cannot be done fast enough to measure the true thermal equilibrium voltage. By measuring a lower value, the thermal resistance always appears smaller than it actually is.

The same problem is encountered with the clamp diode method and with techniques involving measurement of output voltage. In addition, clamp diodes and outputs may be so situated that they won't respond to the actual rise in junction temperature because of temperature gradients across the chip.

The most accurate method for measuring thermal resistance involves a set of test dies, an example of which is shown schematically in Fig. 4. Here, four

series-parallel diodes are placed strategically around three 300-ohm resistors on a monolithic chip. The diodes and resistors are isolated from each other by individual back-biased diodes not shown in the schematic. The design permits a fixed diode current to flow continuously even though power is being applied to the resistors. This method eliminates the need to switch off power and switch on diode current, allowing an accurate measurement of V_{FF} at thermal equilibrium.

Fixed die sizes are used, starting with 30 by 30 mils and increasing by 30-mil increments up to the largest die size, 180 by 180 mils. Reverse breakdown voltages of the back-biased diodes allow up to 10 volts to be applied, which gives a maximum power of one watt.

The characterization of a package normally uses three die sizes, yielding three points on graph showing thermal resistance versus die size (Fig. 1). From this graph, the thermal resistance of any functional device may be found by knowing that device's die size.

Slope measured first

Forced diode current is normally between 3 and 5 milliamperes. A large diode current is used so that diode voltage measurements may be made on the essentially linear portion of the diode forward characteristic. This reduces the effect of increasing forward leakage of the diode due to rising junction temperature, which may affect the calibrated slope.

The slope characteristic is measured first to determine

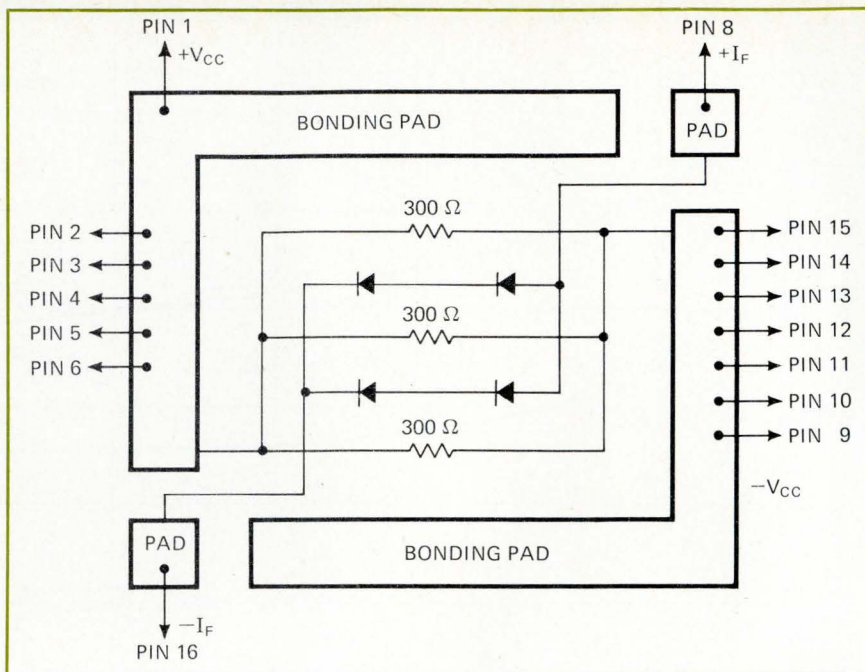

4. Thermal test die. When making thermal measurements, a special die, like the one shown schematically here, can yield more useful data than a functioning chip.

the $\Delta V/\Delta T$ of the diodes. With two diodes in series the forward voltage drop is approximately 1.5V with an average slope of 3.6 millivolts per $^{\circ}\text{C}$. The forward voltage is measured at a minimum of three temperatures, usually $+25^{\circ}\text{C}$, $+75^{\circ}\text{C}$, and $+125^{\circ}\text{C}$. Voltage and temperature measurements must be as accurate as possible. A 5-digit voltmeter should be used and the temperature held to $\pm 1^{\circ}\text{C}$. A 5% error in slope measurement will be reflected as a 5% error in thermal resistance.

In preparation for making a set of thermal resistance measurements, a device is mounted on a pc board via socket pins which accept the device leads. These pins, and a rectangular hole in the pc board directly beneath the device, allow air or oil to flow freely around the device, a requirement for some of the tests that may be performed later.

To measure thermal resistance from junction to case at zero airflow, the pc board and device under test are mounted in an enclosure with holes drilled along the bottom edges. The enclosure prevents any air from flowing around the device.

Two fans are used

To make measurements with airflow, the device is placed in another enclosure where air can be forced across the device. Junction-to-ambient is measured first with 500 linear ft./min. air flow, then at 250 linear ft./min., then at 100 linear ft./min. Two fans separated by a partition are used, one to provide airflow across the device and the other to blow air at a downward angle, producing a wall of air in front of the device under test that prevents air flow variations across the device due to external disturbances.

To measure thermal resistance from junction-to-case, the device is immersed in an oil bath. Air is bubbled through the oil to maintain a flow of oil around the device under test. This flow holds the case temperature at the oil temperature.

Thermal time constants are measured using a storage scope. The diode voltage of the device under test is zeroed out using an external supply and differential scope plug-in. In this manner a vertical scale of as low as 1 millivolt per division may be utilized. By first setting the zero level on the scope and then applying power for a specified amount of time, the thermal time constant curve is stored. Several V_F readings are recorded after each power application. Power application time is increased each time to record from a full scale reading of 10 milliseconds to 50 seconds. The device under test is allowed to cool to the initial V_F after each power application. A stop watch is used to monitor time intervals over 50 seconds.

For all of the three measurements, a fixed method is used:

- Apply an I_F of 5mA and a V_{CC} of 1.00V; allow ample time for the device to come to thermal equilibrium. Thermal equilibrium is reached when a constant V_F can be measured.
- Record V_{FI} , initial forward voltage.
- Record I_{CC1} at $V_{CC1} = 1.00\text{V}$.
- Apply increased V_{CC2} specified for amount of power required.
- Allow 15 minutes for thermal equilibrium.
- Record V_{FF} , final forward voltage.
- Record I_{CC2} at V_{CC2} specified.
- Using the previously calibrated diode slope, calculate Θ as follows:

$$V_{FF} - V_{FI} / \text{slope} = T_J \text{ rise above ambient}$$

$$T_J \text{ rise above ambient} / (V_{CC} \times I_{CC2}) - (V_{CC1} \times I_{CC1}) = \Theta$$

For the thermal time constant measurement, V_{FF} is recorded as V_F since V_{FI} has been zeroed out.

For junction-to-ambient with air flow, V_{FI} is recorded at 500 linear ft./min. and this V_{FI} used at all lesser air flows. □

1K/4K PROGRAMMABLE RAM TESTER FOR UNDER \$10,000!

**Now! For a limited time only--through
November 30, 1974.**

**This turnkey
Production/
Engineering System
at a special low price
which includes:**

- The MD-100 Microprogrammable Pattern Generator
- One Personality Card for any commercial 1K or 4K RAM (See lists)
- A Device Test Program including worst-case test patterns and multiple voltage iterations

1K MOS RAM's

- INTEL 1103, 1103-1, 1103A, 2102, 2105 • MOSTEK 4006, 4008, 4009, 6028, 6029 • AMS 6002, 7001
- EA 1500, 1501 • INTERSIL 7552
- NATIONAL 1103 • AMI 2103, 2102
- SIGNETICS 1103 • AMD 2102
- And Others

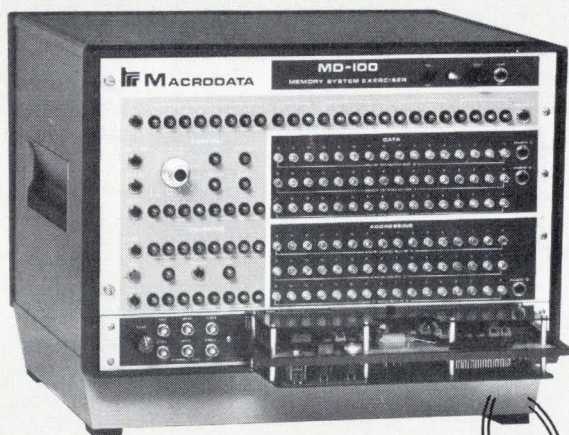

Macrodata's MD-100 is the world-wide standard for memory testing. Over 350 in use throughout the world.

Additional MD-100 System Features:

- Operation by unskilled operators
- Expandability for testing ROM's, PROM's, Shift Registers, UAR/T's
- Expandability for testing RAM cards, up to 65K x 16

4K MOS RAM's

- TI TMS 4030 • MOTOROLA 6605
- MOSTEK MK4096 • INTEL 2107, 2107A, 2107B • AMI S6103 • MIL 7112 • And Others



Fill out this coupon and mail it immediately, or call us on one of these MD-100 Hot Lines — East Coast — (516) 543-8600; Midwest — (312) 297-8746; Northern California — (408) 735-9560; Southern California — (213) 887-5550; Munich, Germany — (0811) 34 56 00; Tokyo, Japan — (03) 985-5266. There is a full 90-day warranty on all hardware.

MACRODATA Corporation, 6203 Variel Avenue, Woodland Hills, Ca. 91364, Phone: (213) 887-5550, Telex: 65-1345

MACRODATA Name _____ Title _____

- I'm ready to buy. Bring one out.
- Please reserve a Model MD-100 for me at the sale price until you bring one out to demonstrate.
- I need more information. Send a brochure.

Company _____
Address _____ Phone _____
City _____ State _____ Zip _____

Public-address amplifier serves as variable ac-power source

by William D. Kraengel Jr.
Valley Stream, N.Y.

Alternating voltages at moderate power, low distortion, and variable amplitude and frequency are obtainable over an extended range by a technique similar to one previously proposed [*Electronics*, Dec. 20, 1973, p. 121], but with simpler and more readily obtainable equipment—namely, an ordinary monophonic or public-address amplifier—but with less power output.

In the earlier proposal, a stereo amplifier was differentially coupled to the output of an audio oscillator to provide low audio frequencies at voltages of 0 to 130 volts. However, the frequency range can easily be extended to low ultrasonic frequencies with even higher voltages. Naturally, the higher the quality of the amplifier and transformer, the greater the frequency range available for any given distortion level. The voltage obtainable is limited by the amplifier's available output power and by the breakdown voltage of the external output transformer.

Using a PA amplifier in place of the more expensive stereo amplifier eliminates the requirement for any input transformer. It has a further advantage in that most

models have 4-, 8- and 16-ohm and 25- and 70-volt outputs, so that the proper impedance or voltage tap is easily selected for the desired output conditions. On the debit side, the output power is only half that of a comparatively rated stereo amplifier, and its distortion may be somewhat greater, especially at frequency extremes.

The output voltage is:

$$E_{amp} = (P_{amp} R_{tap})^{1/2}$$

E_{amp} is the amplifier's output voltage developed across the chosen output tap, which matches load (R_{tap}) at the power level (P_{amp}) required for the final output voltage, E_{out} —which is N times the amplifier output voltage (N is the transformer's turns ratio).

Ordinary filament transformers (used backward) are available with a large selection of input and output voltages to match input impedance and output voltage for almost any amplifier power level. For example, a recent application required a 100-v, 0.1-A supply over the range of 100 to 1,000 hertz. At a typical amplifier's maximum output, 20 watts, the formula given previously shows that an 8-ohm load calls for an output of 12.65 v, at which the load draws 1.58 A. A 12.6/115-v filament transformer steps this up by a factor of about 10, slightly higher than the application requires, but slightly turning down the amplifier's volume control provides the proper level. Thus, the inexpensive amplifier and transformer provide an almost perfect impedance match and an acceptable distortion level over the entire frequency range. □

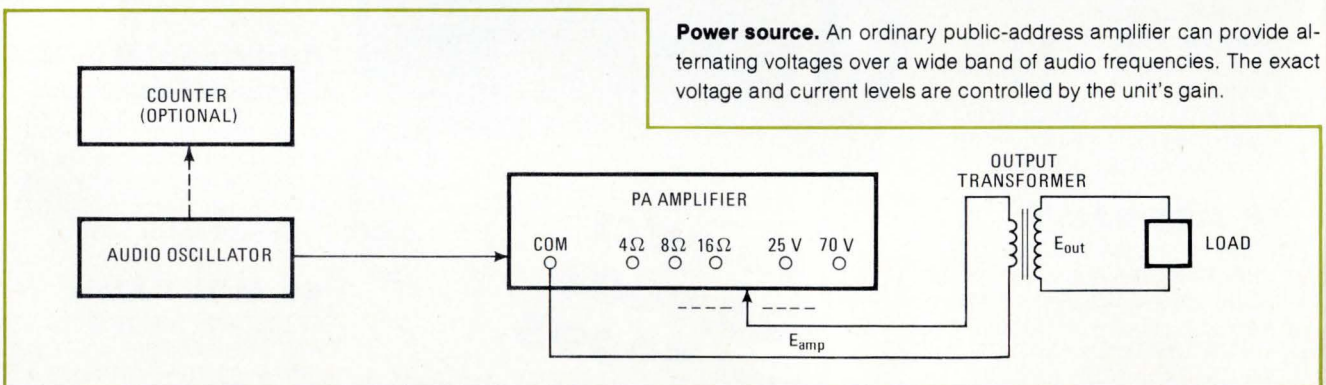

Power source. An ordinary public-address amplifier can provide alternating voltages over a wide band of audio frequencies. The exact voltage and current levels are controlled by the unit's gain.

Two circuits indicate synchro shaft position

by W. Thomas Adams
University of Texas, Austin

The circuitry for either digital or analog indication of shaft positions need not cost much if it simply indicates

the time at which a synchro system passes through a certain point. At any rate, the cost is much higher if shaft position itself is determined very accurately—to within 0.1% and 0.01%—as in so many commercial synchro-to-digital converters.

The two inexpensive circuits discussed here are for a standard synchro with a three-phase stator and one-phase rotor, always rotating in the same direction. It's the kind used, for example, in servo-controlled scanning switches.

In the first circuit for sensing synchro positions (Fig.

Calma presents Norman's latest napkin masterpiece.

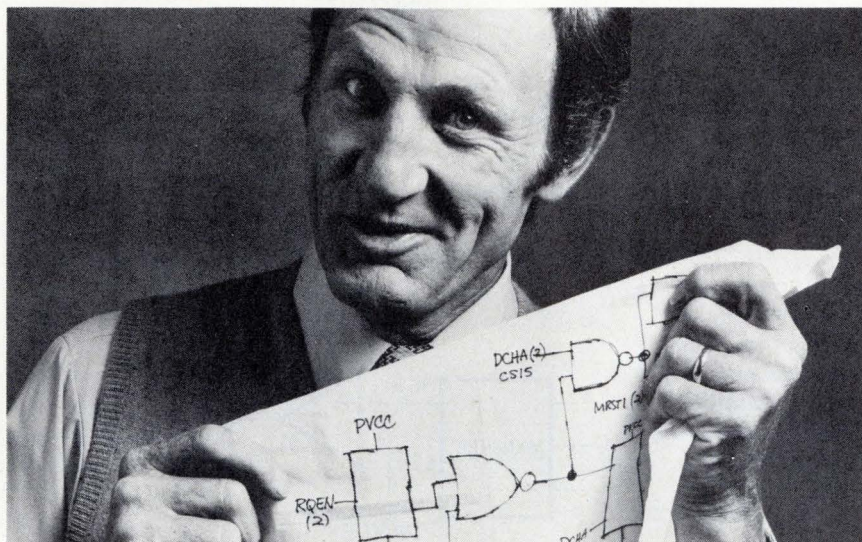

A report on circuit art production. Norman is a conceptual genius. A little sloppy perhaps, but a genius nonetheless. His greatest idea was conceived halfway through an anchovie and pepperoni pizza at Bruno's last Wednesday. After lunch, a young lady earning \$8400 per year turned Norman's

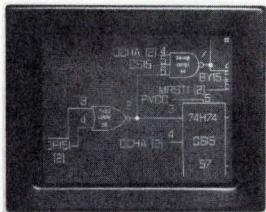

napkin into flawless circuit art in just 54 minutes. She did it on a Calma interactive graphics system. She did it one hundred times faster than a speeding draftsman, about twice as fast as she could on any other system. The Calma system checked her accuracy, drew all the lines and symbols automatically, relieved her of the drudge work.

Changes made lightning fast. While eating pretzels two days later, Norman had a brain-

storm. A way to get even hotter performance out of the same circuit concept. Presto. In microseconds, the original design was retrieved from storage and displayed on the CRT at Norman's own interactive work station. In about three minutes Norman himself modified the original. Electronically. Just that fast the company benefited from his fertile mind with a totally new and competitive circuit. Incidentally, up to six work stations can be included in one system with no degradation of performance.

The fast generation.

Where Calma really makes tracks is the transition from art to production. Each Calma system drives up to three high speed plotters in the background mode. All operate at full rated speeds, never interfering with design

or drafting at the system's six work stations. The secret of Calma's non-stop productivity is that no function ever interferes with another.

Reliable sophistication!

For all its sophistication a Calma system is incredibly reliable. More than 100 have been installed and almost all were up and operating the day they were delivered. Learn how this powerful computer-based graphics system can speed your circuits from conception to production. For literature or to arrange a demonstration, phone or write Calma Company,

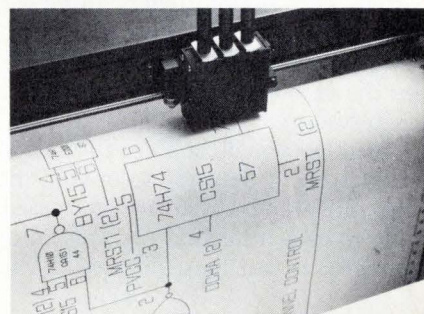

Corporate Marketing Headquarters, 1930 Isaac Newton Square East, Reston, Virginia 20090. Phone (703) 471-1450. European Marketing Headquarters, P.O. Box 6, Marlborough, Wiltshire, SN8 4EW, England. Phone 067286 (Lockeridge) 658.

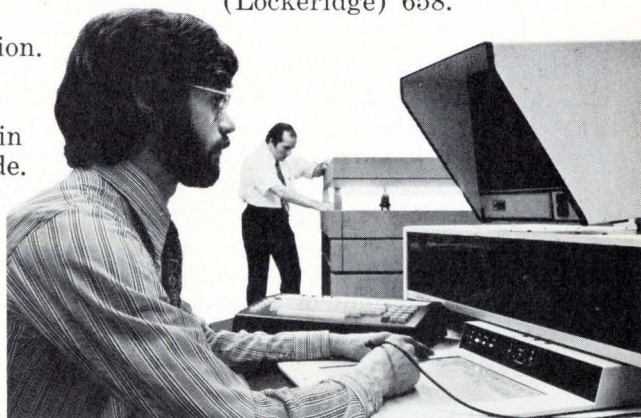

Calma Interactive Graphics Systems.

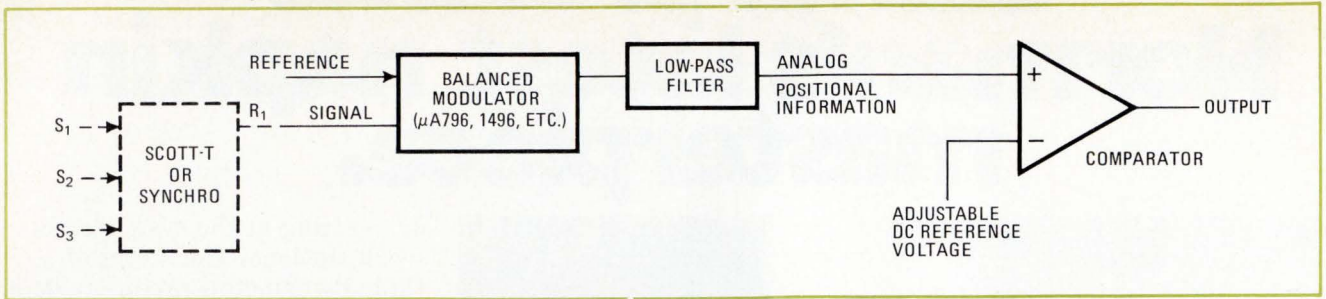

1. Modulator version. Output switches from low to high at the moment synchro shaft passes position defined by voltage adjustment.

2. Flip-flop version. As in Fig. 1, when synchro is at previously established angle, flip-flop turns on to indicate position.

1), a balanced modulator is used as a synchronous detector. It mixes one of the synchro's two output phases with the synchro reference signal (the ac source that drives the rotor winding). If only a three-phase synchro signal is available, a Scott-T transformer or another synchro is required to convert the three-phase signal to two phases.

The detector's output is a sine wave with an instantaneous value directly proportional to the synchro's position. This analog signal can be used directly, or it can be an input to a Schmitt trigger or comparator to provide a logic level that changes state at any desired point on the sine wave corresponding to an angle in the synchro system.

Another way to achieve the same result (Fig. 2) uses a zero-crossing detector to enable the D input of a flip-flop, plus a peak detector to clock the flip-flop. The circuit gives a transition corresponding to an angle in the synchro. It can be calibrated by manually turning the

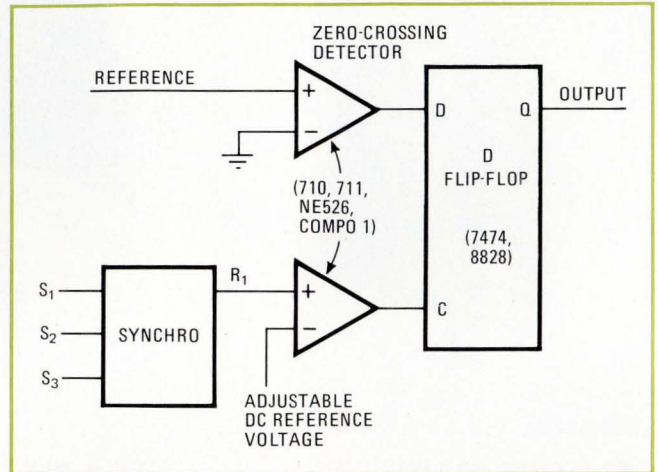

input shaft, or by adjusting the reference voltage on the peak-detector comparator.

For exactness, this circuit requires the modulation frequency (rotor speed) to be much less than the carrier (reference) frequency, because the flip-flop transition can be delayed by as much as one cycle of the carrier, depending on phase relationship of the two signals. □

Convert coordinates and find SWRs graphically

by Vaughn D. Martin
Magnavox Co., Fort Wayne, Ind.

A relatively simple graphical procedure can reduce the error probability and the tedium of conventional mathematical approaches to finding standing-wave ratios, and converting admittance values in rectangular coordinates to impedance values in polar coordinates, including phase angles. The procedure requires only the known impedance, or admittance, and is executed with a pencil, a straightedge, and a compass. It involves just three steps and is more than 98% accurate.

For example, consider the circuit diagram (Fig. 1):

$$\begin{aligned}
 R &= Z_R = 50 \text{ ohms} \\
 G_R &= 20 \text{ millimhos} \\
 C &= 0.92 \text{ microfarad} \\
 X_C &= 1/j(2\pi fC) = 1/j(5.78 \times 10^{-2}) \text{ ohms} \\
 B_C &= 1/X_C = j57.8 \text{ millimhos}
 \end{aligned}$$

$$\begin{aligned}
 L &= 1.2 \text{ millihenry} \\
 X_L &= j(2\pi fL) = j75.4 \text{ ohms} \\
 B_L &= 1/X_L = 1/j75.4 = -j13.3 \text{ millimhos} \\
 Y &= G + jB = 20 + j57.8 - j13.3 = 20 + j44.5
 \end{aligned}$$

In graphical computations, admittance is represented by the hypotenuse of the right triangle in which conductance is represented by the base, and susceptance by the altitude. In many applications, however, admittance is more useful when expressed in polar coordinates. Graphical conversion is accomplished as follows:

First, plot a point corresponding to the complex admittance on the chart (point A). Then, with a compass, draw an arc of a circle with center at the origin and passing through point A. The horizontal coordinate of point B, where the arc intersects the horizontal or conductance axis, is numerically equal to the total admittance; the impedance is indicated on the reciprocal scale by drawing a vertical line to that scale at point C, where the direct reading is 20.4 ohms. The phase angle is determined by the intersection of the graph's outer edge at point D with a line from the origin through point A. This value is about 66°. (Checking mathematically, the exact value is 65.85°.) The impedance, as determined from the chart, is

$$Z = 20.4 / 66^\circ$$

If the value of the susceptance is negative in the rectangular-coordinate form, the polar version is plotted in the same way, but the sign of the angle is negative.

Converting polar to rectangular coordinates is the reverse of this procedure. The first step is to draw a vertical line from point C, representing the impedance, 20.4, to point B on the X-axis. Then swing a 90° arc from point B to point E on the vertical axis, with the center point again at the origin. Finally, with a straight-edge, draw a line from the origin to the known phase angle (point D) at the top of the graph. The admittance is read in rectangular form where the arc and this line intersect (point A).

The same chart can be used to determine the standing wave ratio (SWR) on a transmission line of known characteristic impedance Z_0 for a mismatched load. The semicircles sweeping out from the 20-millimho point on the conductance axis are lines of constant SWR for a transmission line with $Z_0 = 50$ ohms. If such a transmission line has a load of 100 ohms, it should have $SWR = 2$. The reciprocals of 50 and 100 ohms are 20

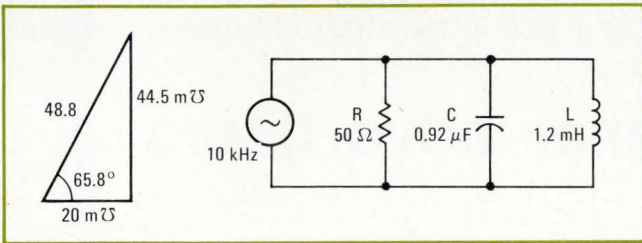

and 10 millimhos respectively. The 20 millimho point on the conductance axis represents the 50-ohm characteristic impedance; the load resistance's conductance of 10 millimhos, at point F, is one end of the semicircle for $SWR = 2$. The other end of the semicircle is at 40 millimhos (point G), corresponding to a load of 25 ohms.

For loads that are not purely resistive, the compass is used again. For example, if the point A is the load admittance, the arc through that point centered on the origin, just as in the coordinate conversion, cuts the conductance axis at B, which is about halfway between the semicircles for $SWR = 2$ and $SWR = 3$. This indicates a SWR of about 2.5, which agrees with the computed impedance of 20.4 ohms ($50/20.4 \approx 2.5$).

Other sets of semicircles can be drawn for transmission lines of different characteristic impedances. In each set, the centers are on the conductance axis. The center of the smallest one is at the point corresponding to the characteristic impedance; each successively larger circle is centered at a coordinate which is half the sum of the two intercepts of that circle with the horizontal axis. These two intercepts, in turn, are the characteristic conductance multiplied and divided, respectively, by the SWR for that circle.

In the chart, for example, the circle for $Z_0 = 50$ and $SWR = 3$ intercepts the horizontal axis at $G \cdot 3$ and $G/3$, or 60 and 6.7; its center is at $\frac{1}{2}(60 + 6.7) = 33.3$. Likewise, for $Z_0 = 75$ and $SWR = 2.5$, $G = 13.3$, the intercepts are at 33.3 and 5.32; the center is at 19.3. □

Engineer's Notebook is a regular feature in Electronics. We invite readers to submit original design shortcuts, calculation aids, measurement and test techniques, and other ideas for saving engineering time or cost. We'll pay \$50 for each item published.

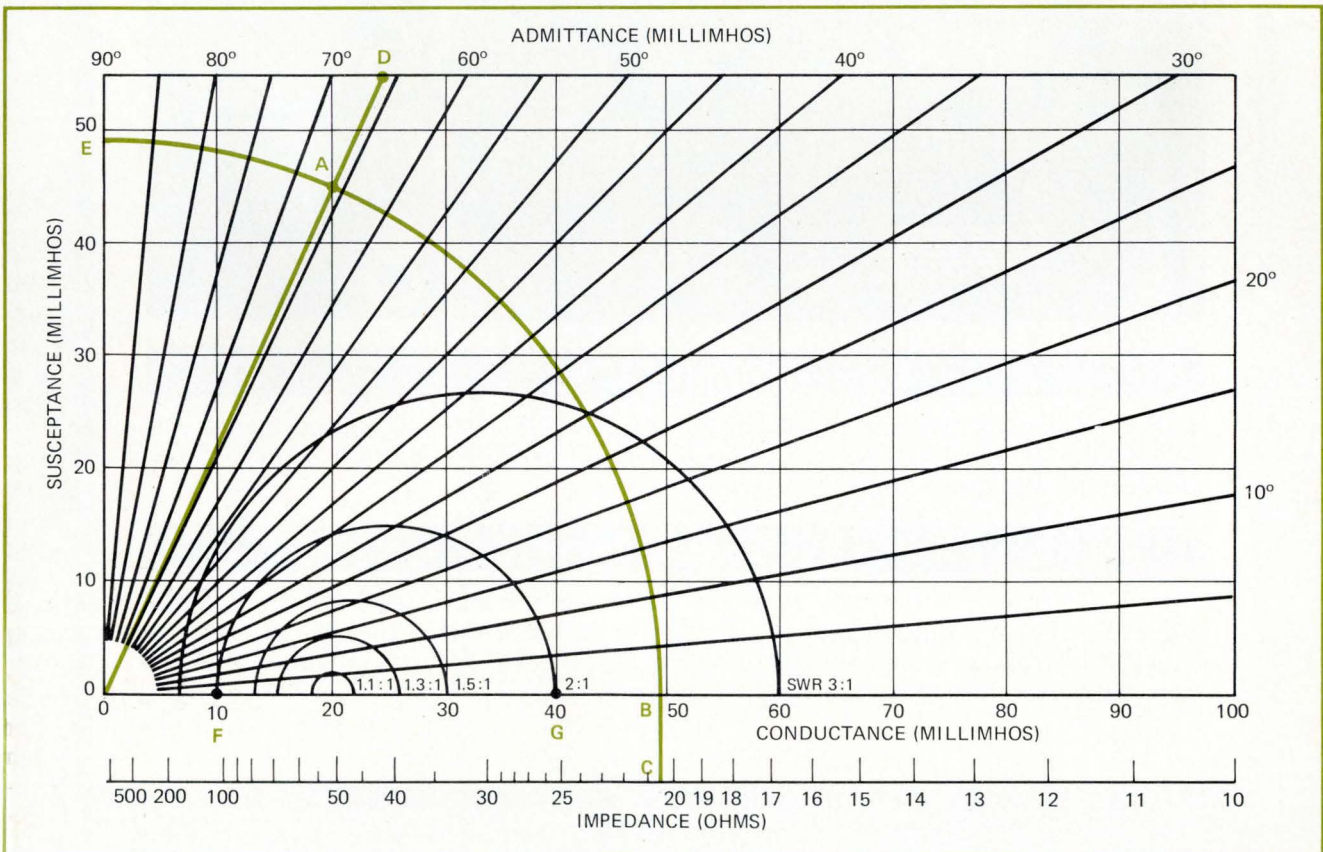

日経エレクトロニクス

NIKKEI ELECTRONICS

Number One in Japan

The key to direct communication in Japan

In Japan, Nikkei Electronics is the key to direct communication between electronic engineers and advertisers of electronics products.

The world's leading enterprises, with their sights trained on the Japanese electronics market, accept Nikkei Electronics as the most reliable medium of its kind in Japan.

In 1973, 316 advertisers placed a total of 2,511 pages of Nikkei Electronics, out of which 15 international advertisers occupied 115 pages. Nikkei Electronics is the only magazine devoted exclusively to electronics in Japan that has attained such distinguished reliability among so many international firms.

Leading international advertisers in 1973 were:

	36 pages
 TEXAS INSTRUMENTS	30 pages
	8 pages

Editorial

Nikkei Electronics is associated with McGraw-Hill's Electronics, offers high level, world-wide technical articles for professional and executive subscribers who need and demand the latest "hot" news on electronics.

Circulation

Nikkei Electronics is the only Japanese electronics magazine authoritatively audited by the Japan Audit Bureau of Circulation, which reported that the number of Nikkei Electronics subscribers in 1973 was 24,678. The latest circulation figures have risen over 15% and have reached the total of 28,710 (May 25, 1974 issue).

For more information, please contact with McGraw-Hill's Electronics sales offices or Advertising Dept. NIKKEI-McGRAW-HILL, INC., Nikkei Annex Bldg., 2-1-2, Uchikanda, Chiyoda-ku, Tokyo, Japan.

Engineer's newsletter

Radio ain't what it used to be

If you've ever tried to fix one of those antique radios that come in those nice cathedral cases, you'll welcome a **new series of books on old radio circuits** from Vintage Radio, P.O. Box 2045, Palos Verdes Peninsula, Calif. 90724. Called "The Most Often Needed Radio Diagrams," the books are **reprints from Supreme publications, the old bible of radio data. The eight-volume set covers radios made between 1926 and 1950.**

And if you radio engineers think you're so smart, check out another new book called "Wireless Telegraphy," a collection of papers presenting those famous discourses held on Friday evenings at the Royal Institute in London from the years 1857 to 1932. Covering **the milestones in the development of radio transmission**, the hardcover book begins with "The Submarine Telegraph" by John Watkins Brett, 1857, and ends with "Radio Communications by Means of Very Short Electric Waves," by G. Marconi. Price is \$32.50 from Halsted Press, 605 Third Ave., New York, N.Y. 10016.

Oscilloscope kits save money

In these days of reduced development programs, **many development labs are turning to kits to build their test equipment** as well as to take care of some temporary slack time for technicians. You'll be surprised at the variety and quality of instruments that now can be gotten in kit form. For example, the Model IO-4510 from Heath Co., Benton Harbor, Mich., is a **triggered sweep, dual-trace, dc-to-15-MHz lab-grade oscilloscope**. It's a kit version of the \$750 Heath/Schlumberger SO-4510 [*Electronics*, June 27, p. 26], but its price of \$549.95 means a **\$200 saving with no loss of performance or features**. Assembly time for two sharp technicians? About six hours.

Report compares many minicomputers

Confused by the overlapping specifications of the spate of new minicomputers? A new report from Datapro Research Corp. **compares the most significant characteristics of 167 minicomputers from 54 manufacturers**. Charts describe processing facilities, peripheral equipment, features and limitations and are **accompanied by a summary of over 200 users' experiences** with the computers. Copies of the report cost \$10 each from the company (1805 Underwood Blvd., Delran, N.J. 08075).

Circuit guarantees logic system is reset when switched on

Two resistors, a capacitor, and a logic inverter are all it takes to assure that your logic system is reset when you switch on the power supply, say Emilio Bernstein and Marc Javnoozon of Jerusalem, Israel. The two resistors are connected as a voltage divider between the supply and ground. Let's call the resistor to the supply R_1 , and the resistor to ground R_2 . The capacitor is placed across R_2 , and the input to the inverter is taken from the junction of R_1 , R_2 , and the capacitor.

When the supply is turned on, the inverter's output at first is high, but the capacitor starts charging until its voltage reaches the switching threshold of the inverter. When this happens, the inverter's output goes low, **producing a pulse that is suitable for resetting subsequent digital circuitry**. When the supply is shut off, the capacitor discharges to ground through R_2 . R_1 determines the capacitor's charging time and charging current.

—Laurence Altman



SPECIFICATIONS

- Frequency Range: 1 - 520 MHz
- Frequency Accuracy: $\pm 0.001\%$
- Resolution: 1 kHz
- Stability: Less than 0.2 ppm per hour
- Output Range: +13 dBm to -137 dBm
- Flatness: ± 0.75 dB
- AM Modulation Range: 0 - 90%
- FM Deviation: 0 - 50 kHz and 0 - 500 kHz
- Internal Modulation Rates: 400 Hz and 1 kHz
- Dimensions: 12" wide x 5½" high x 13¾" deep
- Price: \$1,975

Note: In addition, the entire frequency range is remotely programmable in 1 kHz steps using six lines of BCD programming.

We'll remember your impressive bulk, your incredible weight, the glow of your vacuum tubes burning into the night. Whenever anyone said "signal generator" we thought of you.

But someone new has come along—from Wavetek. Slim, attractive, a mere twenty-five

pounds of solid state ingenuity. Yet the phase-locked Wavetek 3000 can do everything you used to do. (Some things a little better.) All the while consuming less than a tenth the power and a fraction the bench space. Even the price is a little lower.

We could go on, but that

would be cruel. So we'll just print the Wavetek 3000's specifications for you to read . . . and weep.

WAVETEK®

INDIANA INCORPORATED
 P.O. Box 190, 66 North First Avenue
 Beech Grove, Indiana 46107
 Tel. (317) 783-3221 TWX 810-341-3226
 Circle 98 on reader service card

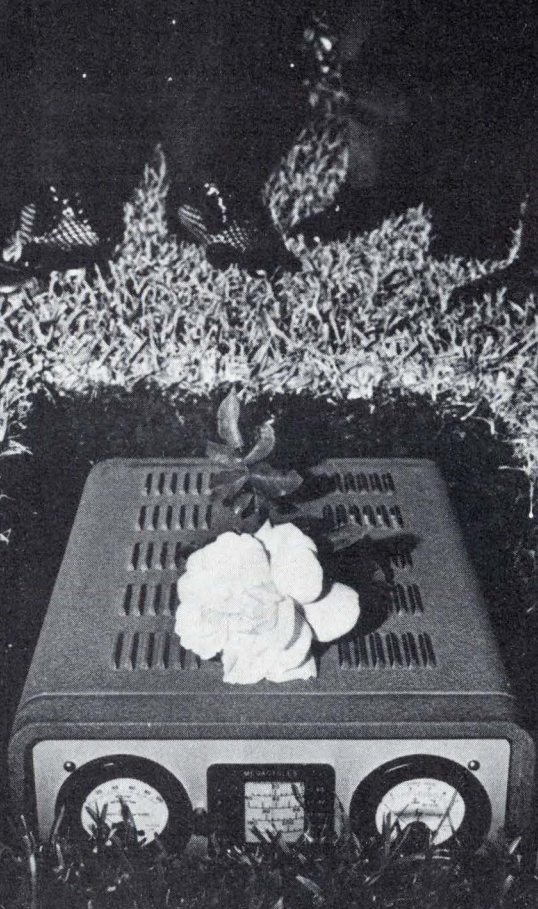

So long, fatso.

Microprocessor directs wafer-prober

Fully automatic version can work over weekend without human intervention; helium-neon laser is part of pattern-recognition system for alignment

by Bernard Cole, San Francisco bureau manager

In the last year or so, the semiconductor industry has shown increasing interest in ways to automate fabrication, production, and packaging procedures.

On the assumption that this interest will continue—and grow—the Cobilt division of Computervision Corp. has introduced a series of new products aimed at automating much of the front-end wafer-fabrication process [*Electronics*, May 2, 1974, p. 159]. Cobilt has now developed a microprocessor-controlled wafer-probe system that in one configuration can test and classify as many as 100 wafers and run 72 hours without operator intervention. The new system, designated the Autoprobe series, has an indexing speed of 5 inches per second, probing accuracy of within a quarter of the device pad area, a resolution of 0.4 micrometer and a repeatability of ± 0.0001 inch. It is designed for wafers up to 4 in. in diameter.

The system comes in three configurations: the model CP-4000 for semiautomatic probing of individual wafers with a minimum of human interaction; the CP-4000 with the CI-412 Autoload subsystem for wafer loading and unloading, and the completely automatic CP-4400, which can operate from 4 p.m. on a Friday through the weekend to 8 a.m. Monday with no intervention by an operator.

T. Roland Fredriksen, engineering manager for the new line, says both of the automatic loading/unloading versions use belt transport mechanisms to transfer wafers between the probing stage and conventional 25-wafer linear carriers. Modular construction, he says, al-

lows periodic upgrading from the CP-4000 to the CP-4400 without major hardware modifications.

The Autoprobe measures 28 by 28 by 31 in. and weighs 170 pounds. It includes a laser sensing and position-alignment system and a 16-bit p-channel microprocessor. The helium-neon laser is part of a pattern-recognition system that uses coherent light to locate the wafer and test-pad positions. The microprocessor provides on two circuit boards all the control logic for both the prober alignment and positioning system and the loading system. Storage capacity is 1,024 words of read-only memory in the CP-4000 and 4,096 words in the CP-4400.

In the CP-4400, says Fredriksen, the operator manually loads the wafer into position, pushes a button to activate a motor that turns the wafer to the right angular position. A speed-scan joystick then allows the operator to accurately align the probe on the first die on the wafer. The probe, which can accommodate up to six device inkers at a time, then automatically tests and marks dies until the wafer is completely tested. An adaptive Z (vertical direction indicator) makes adjust-

ments for variations in wafer thickness and flatness due to wedging or bowing.

With the addition of the CI-412 Autoload subsystem, wafer handling by the operator is eliminated and yield loss due to edge damage and wafer breakage is reduced significantly, says Fredriksen.

In the CP-4400 configuration, the only human involvement required is when a new set of probe cards containing information on wafer and pad location, orientation, and horizontal and vertical alignment is inserted into the microprocessor system. The operator simply checks the settings on a status display and setup control panel, notes any changes, and resets the dials to record the alterations in the microprocessor memory. The completely self-adaptive system then loads, aligns, probes and unloads. All that is required is an X and Y input. A flat angle selector permits digital selection of 0, 30, 60, 90, 180° or any other flat angle.

Delivery will start at the end of the first quarter of 1975.

Computervision Corp., Cobilt Division, 1135 East Arques Ave., Sunnyvale, Calif. 94086 [338]

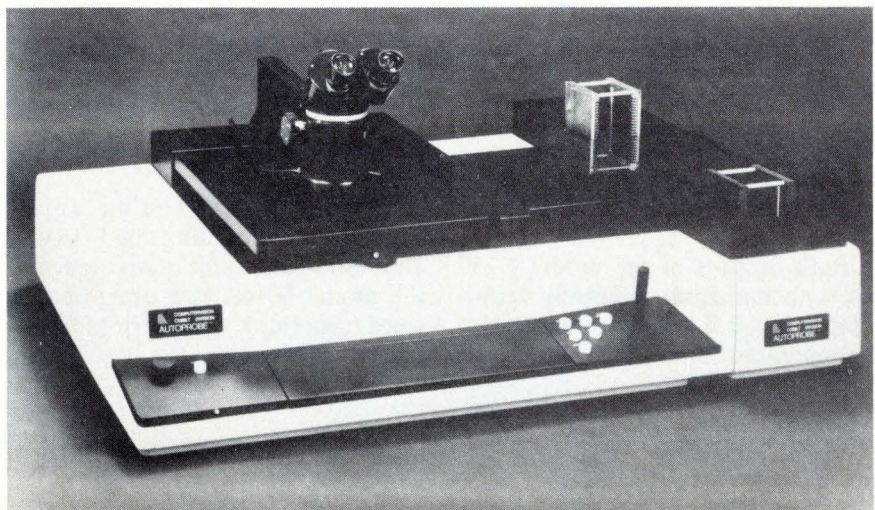

Instruments

Pulser checks high-speed logic

Unit aimed at ECL-type circuits offers rise and fall times of 1.5 ns



Instruments able to operate fast enough to test high-speed digital circuits, like emitter-coupled logic (ECL), are often so expensive that many labs can't afford enough of them to meet all requirements.

E-H Research Laboratories Inc., Oakland, Calif., has one solution—build an instrument designed specifically for use with high-speed circuits, and leave out the frills that many users won't need.

The model G750 pulse generator is that kind of device. It's aimed at the designer or user of high-speed logic families like ECL, offering rise and fall times of 1.5 nanoseconds at 2.5 volts into 50 ohms and 2.0 ns at 5-v amplitude.

The unit offers pulse repetition frequencies from 6 hertz to 50 megahertz, with square-wave operation to 100 MHz. Pulse width is variable from 5 ns to 50 milliseconds, and pulse delay from 25 ns to 50 ms.

Both outputs of the model G750 are backmatched (internally terminated) in 50 Ω to allow the unit to be operated into an open circuit

with a minimum of reflections from the mismatched load. This allows direct stimulus of most logic families with no need for terminating resistors or networks.

External synchronous gating is provided for pulse-burst operation, with selectable threshold and polarity for the gating signal. External drive operation is also provided for master/slave operation of two units or operation from an external frequency source such as a synthesizer or frequency standard.

Baseline offset can be varied ± 4 V via a front-panel control, which can be disabled by a front-panel switch. Single-cycle operation is also available, one output pulse occurring when the single-cycle push button is pressed.

In its double-pulse mode, where the instrument's maximum operating frequency is 20 MHz, spacing between pulses is determined by the delay control, with the first pulse approximately 25 ns after the leading edge of the trigger output.

The G750 also features four outputs: normal and complementary signals on the front panel, subject to the amplitude and offset controls, and similar, but fixed, back-panel outputs that swing from -0.9 V to -1.6 V—standard ECL levels.

By eliminating the variable rise and fall time controls available on some other pulse generators, E-H has kept the price of the G750 down to \$695. By comparison, the firm's older model 137, similar but having additional features, is priced at \$1,950. Delivery of the new pulse generator is from stock.

E-H Research Laboratories, Inc., 515 Eleventh Street, Box 1289, Oakland, Calif. 94604 [351]

50-MHz word generator has variable delays

Aimed at digital testing applications, including integrated circuits and data-communications systems, the model 8016A is a programable word generator with a storage capacity of 256 bits. The instrument

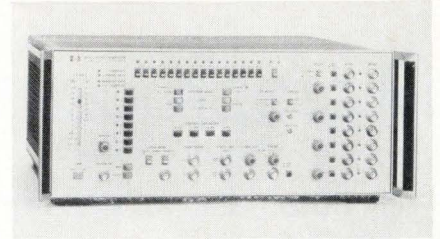

has eight data output ports, which means that the stored data can be delivered as 32 bit-parallel, byte-serial words, or as eight, independent, 32-bit words; or as four 64-bit words, and so on. Clocking is internal at bit rates from 0.5 Hz to 50 MHz. Provision is also made for external and manual clocking. A unique feature of the 8016A is its extensive synchronization circuitry. First-bit, last-bit, and clock outputs are provided, as well as six independently adjustable time delays (four on data output lines, one on the clock channel, and one on the strobe channel). Programming of the word generator is by means of front-panel controls, although a card reader will be available in the future. Price is \$7,560. Delivery is from stock.

Inquiries Manager, Hewlett-Packard Co., 1501 Page Mill Rd., Palo Alto, Calif. 94304 [353]

Linear-logarithmic sweep generator covers 20 MHz

Able to act as a sweep, pulse or ordinary function generator, the model 7271 supplies sine, square, triangle, pulse and ramp waveforms over the 0.0001-hertz-to-20-megahertz range. Sweep width is set by two Kelvin-Varley controls, one each for the start and stop frequencies. Both linear and logarithmic sweep modes are provided. A ramp-hold mode allows the sweep

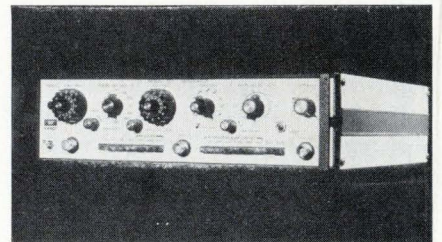

frequency to be held indefinitely so that upper and lower sweep limits can be set precisely. The ramp or sweep waveform may be reset manually at any time from the front panel. The main generator may be triggered or gated internally or externally providing pulse and tone bursts. A gated-sweep mode allows completion of the last cycle in a sweep being terminated. The waveform is symmetrical about ground, but up to ± 15 v of dc offset can be selected to position it above or below ground. In positive fixed offset, the most negative excursion is at ground; in negative fixed offset, the most positive excursion is at ground. A voltage-controlled offset input also permits dc offset to be controlled remotely with an analog voltage. Output of the generator is 30 volts peak-to-peak open-circuit, or 15 v pk-pk into 50 ohms. The instrument offers 80 dB attenuation in 10-dB steps with 20 dB variable. Price of the 7271 is \$1,145. Delivery is two weeks.

Exact Electronics Inc., Box 160, Hillsboro, Ore. 97123 [354]

Level tracer measures noise, harmonic distortion

Although developed for troubleshooting and alignment of telephone program channels, the system 300 channel sweeper test set is suitable for data-channel work and for audio-system testing, cutting measurement and line-up time by 80%, according to early field reports. The 300 measures frequency response, level, weighted and flat noise, and harmonic distortion. An autoranging digital readout and storage oscilloscope display the data. The system 300 consists of a several plug-ins that fit a standard storage oscilloscope mainframe and include: an audio generator; level, noise and distortion meter; return loss and impedance bridge; and a stereo phase and level difference meter. A remotely controlled test generator is offered as an accessory for end-to-end circuit tests.



R-O-R Associates Ltd., 3300 Cavendish Blvd., Suite 150, Montreal, P. Que. H4B 2M8 [357]

Crystal impedance meter spans 8 kHz to 250 MHz

A series of three crystal-impedance meters, suitable for characterizing quartz crystals, covers the frequency range from 8 kilohertz to 250 megahertz. These instruments, smaller and more reliable than conventional vacuum-tube devices, make extensive use of switching and varactor diodes for all band-switching and tuning functions. All models are designed to drive frequency counters with a 50-ohm input impedance. A panel meter indicates crystal activity.

Valpey-Fisher Corp., 75 South Street, Hopkinton, Mass. 01748 [355]

Rf-signal generator is all-solid-state

A completely solid-state rf-signal generator is suited for a-m receiver alignment, TV sweep alignment, rf amplifier gain tests, signal tracing, and as a signal source for production-line and quality-control testing.

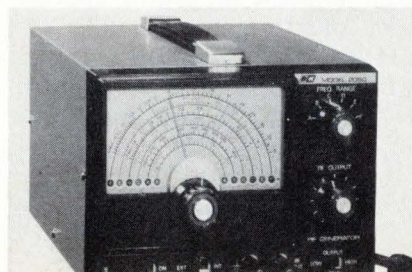

The model 2050 produces unmodulated rf, rf modulated by an internal 400-Hz modulator, and rf modulated by an external signal. Maximum frequency error is $\pm 1.5\%$ of dial setting. The instrument's power supply is zener-regulated, and the FETs used in the rf and audio oscillator stages enhance the stability and linearity of modulated signals. Price of the generator is \$107. Delivery is from stock.

Dynascan Corp., 1801 W. Belle Plaine Ave., Chicago, Ill. 60613 [356]

Counter senses, displays power-line transients

An ac transient-voltage counter helps predict and prevent electrical failures by sensing and recording over- and undervoltages on 120-volt ac power lines. Overvoltage transients are counted and displayed on an LED readout, and low-line conditions are shown on an indicator lamp. The system TCD-640 permits continuous or periodic line-monitoring, without the use of complex test equipment or personal supervision. It assists in analyzing line pollution and identifying potentially dam-



aging transients caused by startup, shutdown, switching, or "brownout" conditions. It can also be used to check ac lines prior to hooking up electronic gear, or breadboards and to troubleshoot electrical malfunctions in existing installations. Housed in a rugged case, the TCD-640 is fully portable and is suitable for field or lab use. Dimensions are 7- $\frac{3}{4}$ in. by 4 in. by 6 in. Price is \$449. Delivery is from stock.

Transtector Systems, 532 Monterey Pass Rd., Monterey Park, Calif. 91754 [359]

Semiconductors

D-MOS method applied to ICs

Double-diffusion process used by Signetics in drivers, switches, other devices

The double-diffusion process, which extracts high-frequency operation from simple metal-oxide-semiconductor structures, has for the first time been applied to integrated circuits. Signetics Corp., the company

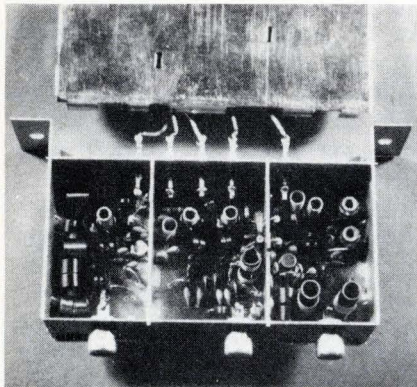

that invented the D-MOS process and had previously used it for discrete devices only, now has developed an rf amplifier-mixer IC and a family of IC analog switches, multiplexers and drivers—all manufactured with the D-MOS technique.

When Signetics conceived D-MOS in 1971, the n-channel process was expected to lead to high-speed analog and logic circuits. The reason is that D-MOS channels can be shorter than in devices made with other MOS techniques and so are faster and dissipate less power in smaller spaces.

However, complex IC processing was difficult to achieve with the double-diffusion method, so Signetics concentrated first on building discrete uhf and microwave transistors with unusually low noise figures and high gains, including D-MOS field-effect transistors.

With the IC-processing problems solved, the company is now intro-

ducing both in the IC amplifier-mixer, designated the SD6000 and housed in an eight-pin plastic package; and the SD5000 family of IC analog switches, multiplexers and drivers.

Tom Cage, engineering manager for the D-MOS effort, says the SD6000 was designed specifically for fm front-end applications, such as varactor and conventional fm tuners, but is also useful in a variety of vhf tuner applications.

The power gain at 100 megahertz is 30 decibels minimum, with a typical noise figure of 2.5 dB. Features of the rf portion include: low input and output capacitances that are constant with automatic gain control (3.0 picofarads and 1.0 pF respectively); low feedback capacitance (0.025 pF); high transconductance (15 millimhos); and wide agc range (50 dB at 100 MHz). Mixer features include high conversion transconductance at low drain currents (10 millimhos). Price of the SF6000 for 100 and up is \$1.05 each.

Signetics is also offering the rf amplifier and mixer portions of the SD6000 as two new vhf dual-gate MOSFET discretes—the SF306 and SD305 respectively. Packaged in four-lead TO-72 packages, the devices are priced at 70 cents each.

The SD5000 family includes the SF5000 and SD5001 series of quad analog switch arrays, the first having a ± 10 -volt capability and the second a ± 5 -V capability. The SD5100 series is a four-input multiplexer or current-summing junction with 0-15- or 0-30-V capability. The SD5200 series is a quad ± 15 -V driver for either the SD5000 or SD5100. All these parts have the inherent D-MOS characteristics of low on-resistance (35 ohms) and low capacitances (input is 2.0 pF, output is 0.5 pF, and feedback is 0.2 pF), which make them attractive in a wide variety of applications, says Cage. Isolation and crosstalk between adjacent switches is -120 dB at 3 kilohertz. Housed in either 14- or 16-lead plastic packages, prices in quantities of 100 are: \$3.20 each for the SD5000, \$2.70 for the SD5001,

\$2.70 for the SD5100, \$2.40 for the SD5101, and \$2.95 for the SD5200.

Signetics Corp., 811 E. Arques Ave., Sunnyvale, Calif. 94086

Integrated FET op amp has 0.1 pA bias current

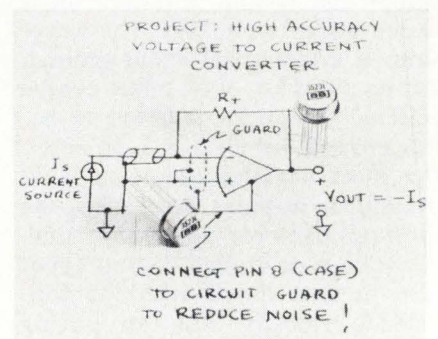

With a maximum bias current of ± 0.1 picoamperes, and an input resistance of 10^{13} ohms, the model 3523L FET-input operational amplifier achieves its low input current without excessive offset voltage, voltage drift, or noise. Because its maximum offset voltage is ± 500 microvolts, the op amp can usually be used without offset nulling, according to the manufacturer. Voltage drift is specified to be $\pm 25 \mu\text{V}/^\circ\text{C}$ maximum, and current noise carries a spec of 0.003 pA peak-to-peak from 0.1 to 10 Hz. Price, in lots of 100, is \$21.50 each. The model 3523J, with a maximum bias current of 0.5 pA, and the 3523K, which is rated at 0.25 pA, carry price tags of \$16.50 and \$18.50, respectively. All members of the 3523 family are packaged in TO-99 cans with the package connected to one of the pins so the package can be used as part of a shield or guard circuit.

Burr-Brown Research Corp., International Airport Industrial Park, Tucson, Ariz. 85734 [414]

Tiny rectifier stacks

handle up to 6,000 volts

Measuring 0.215 inch long by 0.070 in. in diameter, two series of Mini-Metoxilite silicon stacks are avail-

able with peak inverse voltage ratings from 2 to 6 kV. The higher-voltage devices, the manufacturer says, are designed for an oil or an encapsulated environment. The series comprises two families: general-purpose, with a reverse recovery time of 2 microseconds, and fast-recovery, with a T_{rr} of 250 nanoseconds. The general-purpose family can handle an average forward current of 125 milliamperes at 55°C while the fast-recovery family is rated at 100 mA. The two families have one-cycle surge-current ratings of 7 amperes and 5 A, respectively. Because the silicon stacks are assembled by bonding at 900°C, instead of soldering, and because the surfaces are coated with a mixture of metal oxides, the stacks are hermetic, and said to exceed the environmental requirements of current military and

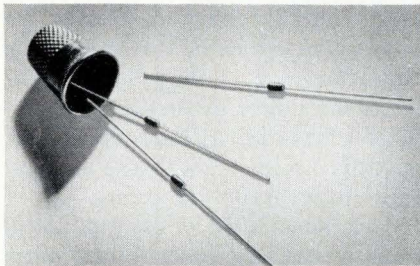

space programs. Prices of the rectifier stacks, when ordered in lots of 100, vary from \$1 to \$5 depending upon voltage rating. Delivery of the units is from stock.

Semtech Corp., 652 Mitchell Rd., Newbury Park, Calif. 91320 [413]

1,024-bit static RAM dissipates 250 mW

Said to be the first bipolar random-access memory with low static power, the Fairchild model 93L415 is a 1,024-bit Isoplanar device with a typical dissipation of 200 mW and a maximum dissipation of 250 mW. The RAM, which has a typical access time of 80 nanoseconds, complements the company's standard model 93415, which has an access time of 40 ns and a power dissipation of 500 mW. Well suited for use

in buffer memories, low-power main memories, terminals, and other peripheral equipment, the 93L415 offers the same power dissipation as existing MOS static RAMs and is five times as fast, according to the company. Prices, in prototype quantities of 100 to 999, are \$22 in plastic, and \$28 in ceramic packages. High-volume production quantities will be available in 1975 at prices below 1¢ per bit.

Fairchild Camera & Instrument Corp., 464 Ellis St., Mountain View, Calif. 94042 [415]

CCD shift register handles 1,024 bits

Suitable for use as an analog delay line, an area imaging unit, or a digital shift register, the CD200 charge-coupled device uses a serial-parallel-serial mode of operation. Organized as a 32-by-32-bit array, the CD200 can store 1,024 elements, but needs only 64 transfers to move an element from the input to the output. The result is reduced degradation of analog signals, and shorter delay times for digital words. Price, in small development quantities, is 250 British pounds (about \$600).

GEC Semiconductors Limited, East Lane, Wembley, Middlesex, England HA9 7PP [416]

ECL read-only memory is industry's largest

Falling midway between a field-programmable ROM and a mask-programmed ROM in both cost and turnaround time, the latest addition to Motorola's MECL 10-k logic family is a 256-by-4-bit device with a typical access time of 20 nanoseconds. Called the MCM10150AL FROM (for factory-programmed ROM), the memory is stored at the factory in wafer form where it is programmed by electrically opening metal links. Unlike a user-programmable PROM, however, the FROM need not contain any circuitry for programming the memory section. Hence, a

greater portion of the chip area can be used for storage, increasing the capacity for a given chip size. Small-quantity price of the MCM10150AL is \$59, exclusive of programming charges.

Technical Information Center, Motorola, Inc., Semiconductor Products Division, P. O. Box 20924, Phoenix, Ariz. 85036 [417]

Decade divider runs at 1.2 GHz

Spanning the frequency range from 100 megahertz to 1.2 gigahertz, the SP8667B is a monolithic frequency divider with an input sensitivity of 0.4 volts. Especially intended for use in frequency synthesizers for navigation equipment, the decade divider uses emitter-coupled logic, and is directly compatible with Motorola's MECL II and with ECL 10-k circuits using external resistors. Power dissipation is 0.5 watt.

Plessey Semiconductors, 1674 McGaw Ave., Santa Ana, Calif. 92705 [419]

Full-wave bridge handles 400-ampere surges

The PW and PWL Series of full-wave rectifier bridges are rated at 30-amperes, continuous, with a surge capability of 400 A. The high surge rating results from an improved diffusion process and a larger junction area with a lower forward-voltage drop. The series are available with peak reverse voltage ratings from 50 to 800 volts. Price of the 400-v bridge, in quantities of 1,000, is \$3.40 each. Delivery is from stock.

Electronic Devices, 21 Gray Oaks Ave., Yonkers, N. Y. 10710 [418]



Data handling

CRT terminal is ruggedized

Graphics unit can be used in oil exploration, process control, oceanography

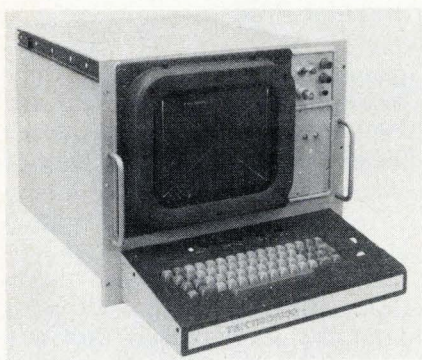

Rugged environments have become familiar terrain to computers, so peripheral equipment must also be equipped for these conditions. That's why the Information Display division of Tektronix has developed the R4011, a low-cost, ruggedized computer graphics terminal. A strengthened, rack-mountable version of the Tektronix 4012 cathode-ray-tube terminal, the 4011 is built around the Navy's specification MIL-E-16400. It meets or exceeds the general environmental specifications of MIL-E-16400, class 3.

Rugged, lightweight paper-print-out terminals are commonly used in outdoor applications, but they do not provide the highly meaningful pictorial representations of graphic display systems using CRT tubes. These systems on the other hand, are vulnerable to temperature, humidity, altitude, vibration, shock, fungus, salt, and dust. Tektronix says it has reduced these vulnerabilities and ruggedized the terminal by special techniques of cushioning and mounting the CRT.

According to Jack McQuain, marketing manager of the division's terminal products group, likely uses of the R4011 would be in oil explor-

ation, where van-mounted exploring rigs often bounce over rough ground; in process control, where heat, damp, and dirt often abound; and in oceanography where salt air, shock, and vibration have to be considered.

To maximize display life and ensure over-all reliability, the R4011 employs ceramic rather than plastic ICs, automatic origin shifting, metal-can transistors, discrete connectors on the circuit cards, coated boards, and all heavy-duty components, as well as board retainers, cable tie-downs, and large component clamps.

The unit has a keyboard selection of the full Ascii set of 96 upper- and lower-case printing characters, or the 63-character teleprinter subset. It is formatted for 74 characters per line, 35 lines per display, for a total of 2,590 characters per display. In the graphic display mode, it has 1,024 by 1,024 addressable points and 1,024 by 780 viewable points. Vector-drawing time is 2.6 milliseconds. Graphics input is via a thumbwheel-controlled cross-hair cursor, 3 through 1,023 in the X direction and 0 through 780 in the Y direction.

Measuring only 16 by 19 by 22 inches and weighing only 80 pounds, the unit is compact enough to slip through a 25-inch hatch and light enough to be easily carried. The direct-view storage CRT is bolted to the casing of the unit, and the display area measures 8 by 6 inches.

Prototypes are now being demonstrated, says McQuain, with production units available in mid-1975. Selling price will be about \$15,000 each, depending on the size of the order (minimum is 20 units).

Tektronix Inc., P.O. Box 500, Beaverton, Ore. 97005 [361]

Minicomputer terminal uses a microprocessor

A smart terminal from Hewlett-Packard, the 2640A, for use with the company's 21MX series of mini-



computers [*Electronics*, May 2, p. 87], is the first H-P terminal to contain a microprocessor. The microprocessor permits the inclusion of a number of advanced features while keeping the cost of the terminal relatively low.

Included with the basic machine are a 1,024-character memory; a generator of 128 characters, including both upper- and lower-case alphabet and all the standard Teletype control characters; and an inverse video capability in which characters are displayed black-on-white instead of the usual white-on-black. Options include additional memory up to 4,096-characters, and an interface for a line printer.

The new display is modularly built so that any major subassembly can be removed for repair or replacement in a few seconds. It can take up to 14 additional printed-circuit boards for other optional features.

Price in the United States is \$2,640 in quantities of six, without options. Additional memory is \$225 for 2,048 characters and \$350 for 4,096. First delivery is scheduled for early 1975.

Hewlett-Packard Co., 1501 Page Mill Road, Palo Alto, Calif. 94304 [362]

Vacuum-column tape transport is quiet

A 10.5-inch-reel vacuum-column tape transport is designed for maximum data reliability and minimum audible noise. The T9000 series is IBM- and ANSI-compatible and available in a full range of standard models with tape speeds from 25 to

75 inches per second. Maximum data-transfer rate is 120,000 characters per second. Claimed to be the quietest vacuum-column transport in its price range, the T9000 has an anti-twitch servo that minimizes tape wear and keeps the reels motionless when they're supposed to be. Other features are a simple tape path, a contoured head cover for easy tape-loading, and plug compatibility with other Pertec transports and formatters.

Pertec Corp., 9600 Irondale Ave., Chatsworth, Calif. 91311 [363]

Flexible disk system offers direct memory access

An IBM-compatible flexible-disk system for interfacing with PDP-11 and Nova minicomputers incorporates from one to four flexible-disk drives. Called the RFS 7400, the system features overlap-peek, direct memory access, and programed in-

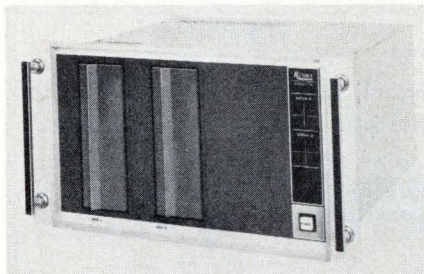

put/output data transfer. Since it uses the IBM 3740 format, the system provides 1.9 million bits of data storage per diskette drive, for a total of 7.6 million bits for a four-drive system. The data transfer rate is 250 kilobits per second. Single-unit price is \$2,695. Delivery is 60 days.

Remex, 1733 Alton St., Santa Ana, Calif. 92705 [364]

Printers are compatible with Varian machines

Based on the Printec 100 line of full-character serial impact printers, the series 620 emulates the standard Varian controller and can be used with Varian operating system soft-

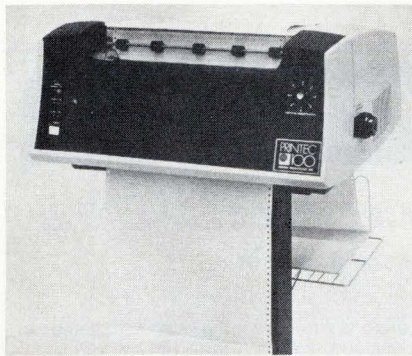

ware without any modifications. The 100-character-per-second printer is plug-compatible with the Varian data machine family of computers and comes complete with a Varian interface card, a diagnostic package, and a 15-foot cable. Price of the printer is \$4,750. Delivery time is 45 days.

Printer Technology Inc., Sixth Rd., Woburn Industrial Park, Woburn, Mass. 01801 [365]

Large-screen terminal speaks many languages

Capable of displaying 1,920 characters of many languages on a 15-inch non-glare screen, the Uniscope 200 display terminal provides a clear, sharply defined image on a flicker-free green phosphor screen. Using a 7-by-9 dot-matrix character, the terminal is available with two display formats: 24 lines by 64 characters per line, or 24 lines by 80 characters per line. The terminal will be available initially in six special languages besides its domestic U. S. version. These are Spanish, French, German, Swedish, Danish, and a special English version for the U. K. Lease prices for the basic terminal begin at

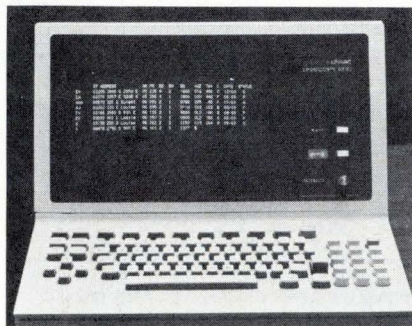

\$121 per month including maintenance. The purchase price is \$4,128. Sperry Univac, P. O. Box 500, Blue Bell, Pa. 19422 [367]

Magnetic wand is insensitive to velocity, direction

Designed for use with electronic cash registers and other memory systems, the model MW-500 magnetic wand is insensitive to both velocity and direction and thus may be used with complete freedom by right- and left-handed personnel. The wand can handle recorded data densities as high as 300 bits per inch, and has a maximum data



transfer rate of 12,000 bits per second. Head life is guaranteed to be at least one million passes. Small-quantity price is \$118.95. Delivery is from stock for standard units, up to 45 days for specials.

Advanced Magnetic Products Inc., 7067 1/2 Vineland Ave., North Hollywood, Calif. 91605 [366]

Paper-tape system needs little space in computer

A paper-tape system for the PDP-11 computer series occupies a minimum of space within the computer itself. The system's controller board replaces the terminator-resistor board that comes with the computer. The reader assembly fits into a standard 19-inch rack. Drive speeds of 80 or 100 characters per second are available. Single-quantity prices for the system start at \$1,250. Delivery is 30 days.

Wilson Laboratories Inc., 2536-D East Fender Ave., Fullerton, Calif. 92631 [369]

SEARCHLIGHT SECTION

- CLASSIFIED ADVERTISING
- BUSINESS OPPORTUNITIES
- USED OR SURPLUS EQUIPMENT

RF-PACKAGES—MICROWAVE SYSTEMS

WORLD'S LARGEST RADAR & MICROWAVE INVENTORY

AUTOTRACK ANTENNA SCR-584 RADAR SYSTEM

360 deg azi 210 deg ele. Better than 1 mil. accuracy. Missile vel. accel. and slew. rates. Amplidyne servo control. Handle up to 20 fr. dish. Compl. with control chassis. ALSO in stock 10 cm. van mounted radar system. Conical scan. PPI, 6 ft. dish. Ideal telemetry, balloon missile rocket trk, ECM range. 600 pg. instr. bk. on compl. radar avail. \$25 ea.



1 MEV LINEAR ACCELERATOR

Dual Mode, Ion or Electron. RF Drive, 300 KHZ at 45 KW. Includes control console, RF unit, accelerator, etc.

MOD IV HI-RES MONOPULSE TRACKER

Instrumentation radar; freq. 8.5-9.6 GHz, Pwr: 250 KW, 1 mil tracking accuracy. 6' Fresnel lens antenna with 4 horn monopulse feed. Trk. Rng. 50 or 200 mi.

PULSE MODULATORS + H.V.P.S.

245 KW LINE PULSER Output 16 KV at 16 amp. .25 μ s at 4000 PPS.

405 KW FLOATING DECK PULSER Output 20 KV at 20 amp. 1 μ s to 10 millesec pulse.

500 KW LINE PULSER Output 22 KV at 28 amp. .4/1.75/2.25 μ s at 2500/550/300 PPS.

1 MW HARDTUBE MIT MODEL 9 Output 25 KV at 40 amp. .25 2 μ s at .002 D.C.

2.0 MW LINE PULSER Output 30 KV at 70 amp. 1/2 μ s at 600/300 PPS.

3 MW LINE PULSER Output 39 KV at 75 amp. .25/1 μ s at 500 PPS.

10 MW LINE PULSER Output 76 KV at 135 amp. 2.5 μ s at 350 PPS.

17 MW LINE PULSER Output 17 KV at 1000 amp. 2-5 μ s at 150-2000 PPS.

RECON DRONE CONTROL RADARS

X Band systems autotrack and search complete with plotting boards. Fully mobile van mounted. Gnd to air links and beacons also in stock.

MICROWAVE LINK EQUIPMENT

Freq. 7.1-7.9 GHz, Pwr. 100 mw., 4 channels. Transmits video, pulse, synchro, and voice information. Mfr: Motorola. Others in stock.

SEND FOR FREE 24 PG. CATALOG
ON YOUR LETTERHEAD

SPARE PARTS IN STOCK

Nike Ajax, Nike Hercules, M-33, MPS-19, TPS-ID, FPS-10D, FPS-6, SPS8, SCR-584, HIPAR. Many more, write.

RADAR & RF PKGS.

34ghz 40 kw Pulse RF pkg
24ghz 40 kw Pulse bomb toss system
16ghz 130 kw Pulse B-58 search radar system

X BAND SEARCH 40 KW PULSE WEATHER RADAR

BAND AUTOTRACK AUTOTRACK GPG-1/MPQ-29

X BAND AUTOTRACK 250KW PULSE M-33

X BAND BEACON 400 W PULSE AN/DPN-62

X BAND AUTOTRACK 50KW PULSE B-47 FIRE CONTR.

C BAND WEATHER RADAR 250 KW PULSE C PS-9

C BAND HT. FDR. FPS-26, 5 MW; TPS-37, 1 MW

C BAND 285 KW PULSE Search AN/SPS-5

S BAND AUTOTRACK 500 KW PULSE 10' DISH

S BAND 1 MEGAWATT COHERENT AN/FPS-18

S BAND 1 MEGAWATT PULSE NIKE ACQ.

S BAND 5 MEGAWATT HEIGHT FINDER AN/FPS-6

S BAND MORTAR LOCATOR 250 KW MPQ-10A

L BAND 500KW PULSE AN/TPS-ID/E & FPS-75

L BAND 5 to 20KW PULSE

400 mhz 1KW CW AN/FPS-23

225mhz 1 MEGAWATT PULSE AN/TPS 28

CW 4-5ghz 1 KW

CW .950-5ghz 150 WATTS

CW 1.5 mhz-10.5ghz 5 WATTS

CW 1.7-2.4ghz 10 KW

RADIOSONDE DISPENSER

Airborne dispenser, gas or air operated. Size 4' long 1.5 dia. Type AMQ 19



**Radio
Research
Instrument
Co., Inc.**

3 QUINCY ST., NORWALK, CONN. 06850
(203) 853-2600

CIRCLE 951 ON READER SERVICE CARD

SAME DAY SHIPMENT Minis & Peripherals

PRINTERS

Some "BRAND NEW"

DATA PRODUCTS

2440— 700 LPM

2470— 1250 LPM

MOHAWK DATA SCIENCES

4320— 300 LPM

4330— 380LPM

CONTROL DATA CORP.

9322— 200 LPM

9352— 600 LPM

ALSO

CENTRONICS, POTTER, CDC

A. B. DICK, IBM, HIS, UNIVAC

(617) 261-1100

Send for Free Report "Maintenance of Computers"

AMERICAN USED COMPUTER CORP.

P.O. Box 68, Kenmore Sta., Boston, MA 02215

member COMPUTER DEALERS ASSOCIATION

CIRCLE 957 ON READER SERVICE CARD

free catalog

POTTING APPLICATORS

MANUAL OR AIR OPERATED

2 1/2cc 6cc 12cc 30cc

FOR POTTING, ENCAPSULATING ETC.

PHILIP FISHMAN CO., INC.

7 CAMERON ST. WELLESLEY, MASS. 02181

CIRCLE 952 ON READER SERVICE CARD

FREE ALARM CATALOG

Full line of professional burglar and fire alarm systems and supplies. 96 pages, 450 items. Off the shelf delivery, quantity prices.



mountain west alarm

4215 n. 16th st., phoenix, az. 85016

CIRCLE 953 ON READER SERVICE CARD

MANUFACTURER'S REPS WANTED

Custom vacuum former and rotomolder wants a mfg. rep to call on OEM's in the northeast. We specialize in complex housings, bezels, carrying cases, etc. Some plastic experience helpful. MRW-6017

ELECTRONICS, Class. Adv. Dept.
P.O. Box 900, N. Y., N. Y. 10020

CIRCLE 954 ON READER SERVICE CARD

CORRESPONDENCE COURSE

Write better proposals, reports, letters. Take "Basic Clear Writing for Technical People" correspondence. Information free. Communications Workshop, Suite 2C, 7318 Lurgy, Houston, Texas 77036.

PRINTED CIRCUIT FACILITY

(Equipment)

Pemco Etcher Uni-Drill, Epec Plating & Electroless Tanks #18 & 21; Epec Developer/Rinse #30C, Epec Roller Coater #17, Polypropylene Sink, & Misc. Supplies, Parts, etc.

CALL: R. BUSKARD

at 516/549-8200

CIRCLE 956 ON READER SERVICE CARD

NEW SURPLUS—FREE CATALOG

MM5203Q-1, 2048 BIT RE-PROM: \$19.50.
MM5260, 1024 BIT LOW PWR. RAM: \$5.00.
1101A, RAM: \$2.50; 8288, + 12: \$2.55.
8038, VCO: \$5.95; NE526, VOLT COMP: \$1.10.
NIXIE B585381: \$1.50; 2N5942, 2N6166: \$16.00.

ELECTRONIC DISCOUNT SALES

138 N. 81st St., Mesa, AZ 85207

CIRCLE 958 ON READER SERVICE CARD



EMPLOYMENT OPPORTUNITIES

Send New Ads to:

Electronics

Class. Adv. Dept.

P.O. Box 900, N.Y., N.Y. 10020

WOMEN'S CAREER CAUCUS

New York
Career Weekend
November 15-16

Chicago
Career Weekend
December 6-7

Reps from over 16 companies will be interviewing candidates to fill over 100 top level positions in:

ACCOUNTING
ENGINEERING
R & D

TECH. SALES
MARKETING
PROG./SYSTEMS + more

NO COST TO JOB APPLICANT

Send resume to: Ms. Karlyn Metcalf, Dir.:

WOMEN'S CAREER CAUCUS

645 N. Michigan Ave. Chicago, Ill. 60611

Qualified Applicants Will Be Notified

A Div. of DN & A Equal Opportunity Employers M/J

Q. Whom do I contact or call to re-new my classified ad or make corrections?

A. Write Electronics, Class. Adv. Dept., P.O. Box 900, NY, NY 10020 or call: (212) 997-6585 or 6586. Give full company name, size of ad, & date or dates it is scheduled to appear.

New products

Packaging & production

Bayonet plug resists vibration

Spring-loaded detent ring, metal-to-metal bottoming make unit airworthy

Bayonet plug connectors, for all their popularity, don't make the best air-travelers; the constant, strong vibrations of an airplane subject them to a lot of wear. But a new TRW/Cinch connector is said to combine the convenience of standard twist-lock devices with the rigidity and reliability of thread-coupled, lock-wired units. In fact, like the latter, the new bayonet devices are expected to last for the life of any aircraft in which they are installed.

Their reliability has been improved by elimination of the detents usually found in the connector's coupling ring. These detents allow for play between the connector plug and jack, and hence allow them to wear. The improved Nuline MMB (for metal-to-metal bottoming) connector uses a separate spring-loaded detent ring inside the coupling ring. As can be seen from the drawing above, when the coupling has been rotated to the end of its ramp inclination, three things happen simultaneously: the mating receptacle shell is clamped against the flange of the plug shell, the bayonets of the receptacle engage the holes in the plug coupling ring, and the three detents in the spring-loaded detent ring engage three fixed rollers to hold the coupling ring in the proper position.

As the drawing also shows, the connectors include a special preload member. This component is adjusted during manufacture to apply a pre-set clamping force over the mated pair of connectors. The force is set in a special gage high enough to counteract opposing forces caused by vibration in a specified

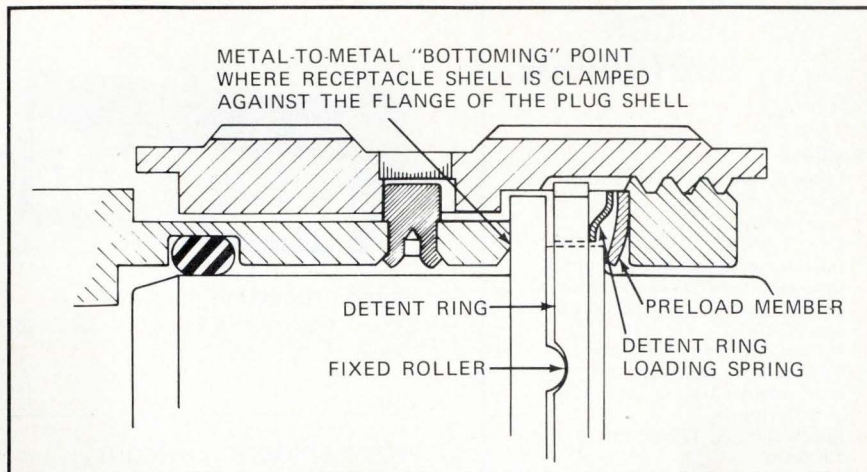

environment. Once set, the preload member is permanently locked in position during the manufacturing process.

The new plug design is fully compatible with standard MIL-C-26500 and BACC-45 bayonet receptacles and can be used as a direct replacement for BACC-63AL, BACC-45FT, or standard MIL-C-26500 plugs. Thus, only the plug portion need be used in most retrofit applications. Moreover, the new connectors utilize standard contacts as well as standard crimping, insertion, and removal tools.

Delivery time is 14-16 weeks.

TRW/Cinch Unit, Electronic Components Division of TRW Inc., 1500 Morse Ave., Elk Grove Village, Ill. 60007 [391]

Electro-pneumatic dispenser cuts adhesive waste

An automatic applicator for cyanoacrylates and anaerobics makes it easier to handle instant-contact ad-



hesives. The electro-pneumatic dispenser, model 1000DV, provides automatic, repetitive deposits down to microdot sizes and thus can prevent joint failures that can occur when too much or too little adhesive is applied. For low-viscosity materials, a variable syringe-vacuum control can be set to eliminate drip and, hence, time-consuming clean-up. The compact machine is a replacement for both squeeze-bottle and toothpick deposit techniques. Price is \$305.

Electron Fusion Devices Inc., 977 Waterman Ave., East Providence, R. I. 02914 [393]

Nondestructive tester measures gold thickness

The Micro-derm G-5 system uses the beta-backscatter principle to measure thicknesses of gold plating as thin as a millionth of an inch and is intended to help manufacturers avoid overplating this expensive material. The system qualifies as the beta-backscatter instrument required under MIL-G-45204B—the military specification for measuring electrodeposited gold plating on metal surfaces. The instrument is suited for measuring gold-plated circuit-board fingers, flat packs, IC frames, connectors, and other hardware. The system comes with either digital or analog-meter readout and according to the manufacturer, provides direct readings in less than 10 seconds even when used by un-

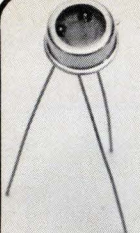

NEW

HIGH PERFORMANCE SILICON PHOTODIODE

Features:

- * Large active area exactly .1cm² for ease of calibration.
- * Low noise
D* = 1.5 x 10⁻¹³ watts/Hz^{1/2}
- * Fast pulse response, rise and fall time less than 20 nanoseconds.
- * Rugged hermetically sealed package TO-5.
- * National Bureau of Standards calibration traceability.
- * Wide angular field of view 100° at 50% points.
- * Spectral range 325nm to 1100nm.
- * Custom filtering with full scan spectral calibrations available.
- * Flat spectral response available.

Applications:

- * Laser, L.E.D., incandescent and natural light measurements.
- * Bar CODE, OCR, and high speed low light level counting.
- * Laboratory standard reference.
- * Photometers, radiometers, and colorimeters.

international light INC.

Dexter Industrial Green, Dept. E
Newburyport, Ma. 01950 / 617-465-5923



Circle 108 on reader service card

New products



skilled production personnel.

Unit Process Assemblies, Inc., 60 Oak Drive,
Syosset, N. Y. 11791 [394]

Wave-soldering system
runs at 18 feet/minute

A medium-volume, completely integrated wave-soldering system incorporates the interchangeable-nozzle concept. When used with the advanced Lambda nozzle, it can solder at speeds up to 18 feet per minute. In-line cleaning and an OSHA-type vent system are available as options. The model 409 comes in sizes capable of handling 12-, 15-,

ICS 1-110, Types 1, 2, 3, 3S, 4, and 12. Called the MA series, the housings are suitable for enclosing electrical, pneumatic, and hydraulic equipment.

Zero Manufacturing Co., Zero-East Division,
288 Main Street, Monson, Mass. 01057
[398]

Flat-cable stripper
handles 3-inch widths

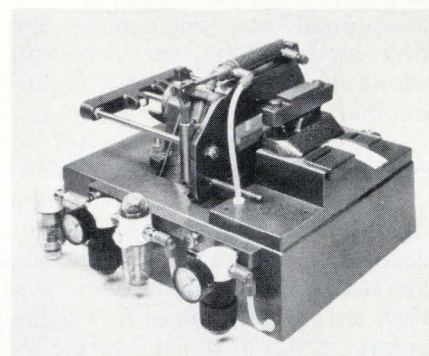

The model 49 pneumatic flat-cable stripper automatically strips most extruded insulation—including Teflon—in one operation. The stripper can handle cables up to three inches wide and strips up to one inch long. Each operation takes only two seconds and damages neither the insulation nor the conductor. If desired, a small tab of insulation may be left attached to the conductor leads to keep them separated for automatic soldering.

Carpenter Mfg. Co., Fairgrounds Drive,
Manlius, N. Y. 13104 [397]

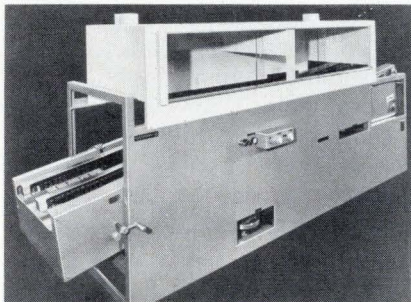

18-, and 24-inch-wide boards. Standard systems start at \$11,400. Delivery time for the wave-soldering system is six to eight weeks.

Electrovert Inc., 86 Hartford Ave., Mt. Vernon, N. Y. 10553 [396]

Compact blower
delivers up to 850 ft³/min

A blower that occupies less than one cubic foot of space delivers up to 850 cubic feet per minute at pressures up to 6.5 pounds per square inch or vacuums approaching 8 in. of mercury. Its high-efficiency planetary drives eliminate the need for gears, assure low noise levels, and provide nonpulsating, oil-free air or gas. The blowers, which can be manifolded (parallel operation)

Aluminum housings
are airtight

A series of airtight, all-aluminum industrial housings is constructed of corrosion-resistant, deep-drawn aluminum and is suitable for use both indoors and out. The versatile housings meet the seal requirements of NEMA Enclosures Specification



1/4W

RESISTOR

FIXED COMPOSITION
FIXED CARBON FILM
SEMI-FIXED (1/8W)



TAIYO DENKI
CO., LTD.

225-3, 7-cho, Nakamachi, Ohtori, Sakai City,
Japan 593 Phone: 0722 (62) 8281

108 Circle 123 on reader service card

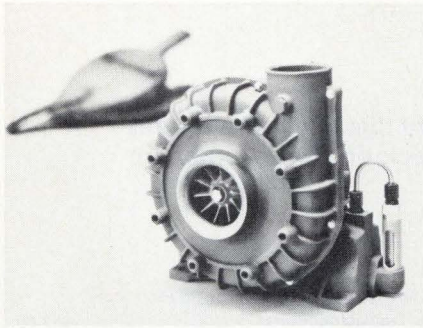

without any balancing problems and can be staged (series operation) to produce higher pressures, fit within a 12-in. cube.

Paxton Products, Inc., 1664 12th St., Santa Monica, Calif. 90404 [400]

High spindle speed improves surface finish

A design improvement available for new engraving machines as well as for those already in the field, the Turbo Jet Air Spindle provides a better surface finish and increases engraving versatility when used in such manufacturing operations as the grinding of small cavities, drilling electronic carbon blocks, drilling electronic circuit boards, and deburring both soft and hardened materials. The spindle, with speeds of 30,000 to 100,000 revolutions per minute, comes with collet sizes of 0.1 and 0.125 inch.

H. P. Preis Engraving Machine Co., 651 U. S. Highway 22, Hillside, N. J. 07205 [395]

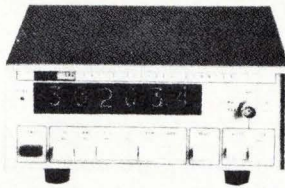
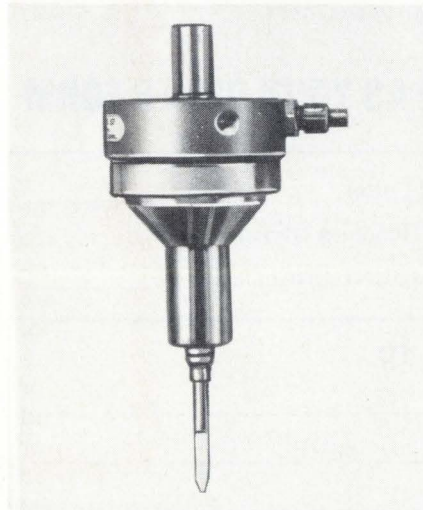

**CLOSE OUT SALE
6-DIGIT FREQUENCY
COUNTER
\$249.95
WHILE THEY LAST**

FLUKE 1941A COUNTER AT A NEVER TO BE REPEATED PRICE. NEW UNITS WITH 1 YEAR FULL WARRANTY. 6 digit gas discharge display, 5 Hz to 40 MHz frequency range, with 40mV rms input sensitivity, 4 standard gate times 1 msec, 10 msec, 100 msec, 1 sec and special 600 msec gate time for RPM measurements. Switchable low pass filter and attenuator. Measures Frequency, RPM and Totalizes. All push-button controls. Switchable 115/230V at 60/50 or 400 Hz.

TO ORDER SPECIFY 1941A AT \$249.95 PLUS \$2.75 SHIPPING & HANDLING (Residents of NJ, IL, TX & CA Add 5% Sales Tax)

PAYMENT BY CHECK OR MONEY ORDER COD BANK AMERICARD
 MASTERCHARGE AMERICAN EXPRESS
 PURCHASE ORDERS ACCEPTED FROM CREDIT WORTHY COMPANIES



TUCKER
ELECTRONICS COMPANY
P.O. BOX NO. 1050, DEPT. F-1
GARLAND, TX. 75040

CALL TOLL-FREE
800-527-4642
(In Texas call collect 214-348-8800)

ANOTHER GREAT SALE EXCLUSIVE FROM TUCKER

Circle 109 on reader service card

Before you buy

COMPARE MODULATION METERS

We invite you to use Radiometer's Type AFM2 or AFM3 in your laboratory on a 10 day trial. Check features, specifications and especially performance in your own precise measurements of FM deviation and AM modulation on carriers from 5 MHz to over 1 GHz. Determine distortion levels of signal generators or transmitters and make sensitive measurements of incidental AM or incremental FM on carriers.

You can check all these and more.

For details contact us at
811 Sharon Drive,
Cleveland, Ohio 44145
Phone 216/871-8900

 **THE
LONDON
COMPANY**

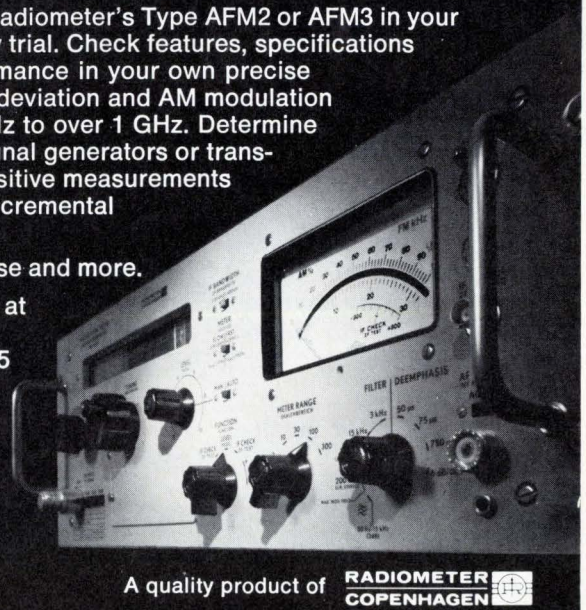

A quality product of **RADIOMETER
COPENHAGEN** 

FEATURE ARTICLES FROM ELECTRONICS MAGAZINE ARE NOW AVAILABLE IN REPRINT FORM!

Valuable additions to your electronics library are now available thru this exclusive reprint service. Just check the articles you wish to order and enclose check or money order for prompt service.

No. of Copies Wanted		No. of Copies Wanted	
_____	R- 11 Computer-Aided Design	_____	R-308 Program for Transition from NonLinear to Linear Transistor Model
_____	R-012 Special Report on Gallium Arsenide	_____	R-310 Penetration Color Tubes are Enhancing Information Displays
_____	R- 15 Special Report on New Look in LSI Packaging	_____	R-312 Leadless, Pluggable IC Packages Reduce Costs
_____	R-016 Special Report on The Transistor: Two Decades of Progress	_____	R-316 Hybrid Circuit Technology Solves Tough Design Problems
_____	R-017 Special Report on Ferrites	_____	R-318 Buckling Up for the Bumpy Road to Detroit
_____	R- 18 Reshaping the EE for the Seventies	_____	R-320 Planar Interconnection Techniques (Designer Must Plan Early for Flat Cable)
_____	R-022 Active Filters: Part 2, Varying the Approach	_____	R-322 Special Report: The New Displays Complement the Old
_____	R-023 Special Report: Tomorrow's Communications	_____	R-324 Semiconductor Memories Are Taking Over Data-Storage Applications
_____	R-027 Consumer Hazards: Why They Happen, How They Can Be Fixed	_____	R-326 Optical Spectrum Report and Optical Spectrum Chart
_____	R-031 Circuit Designer's Casebook (U.S. Only)	_____	R-328 Pervasiveness of Electronics Entire Issue of Electronics
_____	R-032 Active Filters	_____	R-400 Japanese Forecast 1974
_____	R-033 Active Filter Chart & Infra-Red Detector Chart	_____	R-402 European Forecast 1974
_____	R-101 Special Report: The Right Numeric Readout, a Critical Choice for Designers	_____	R-404 U.S. Forecast 1974
_____	R-104 The New Concept for Memory and Imaging: Charge Coupling	_____	R-406 Logics New Design Tools
_____	R-107 Wanted for the '70s: Easier-to-Program Computers	_____	R-408 Bringing Sight to the Blind
_____	R-110 Automation for Survival and Profit	_____	R-410 Passive Components
_____	R-113 Optoelectronics Makes It At Last (3 part series)	_____	R-412 Liquid Cooling Semiconductors
_____	R-203 East Europe Market Report	_____	R-414 Simplified n-Channel Process
_____	R-205 Bridging the Analog & Digital Worlds with Linear ICs	_____	R-416 Optical Waveguides Look Brighter
_____	R-207 Technology Gap Starts to Close for Computer Peripherals	_____	R-418 Computer Analyses of RF Circuits
_____	R-209 Semiconductor RAMs Land Computer Mainframe Jobs	_____	R-420 Computerized Text-Editing and Typesetting
_____	R-211 Electromagnetic Spectrum Report and Foldout Chart	_____	R-422 A Microprogrammable Minicomputer
_____	R-213 Electromagnetic Spectrum Chart (rolled in mailing tube)	_____	R-424 Microprocessor Applications
_____	R-306 Charge Coupling Improves Its Image, Challenging Video Camera	_____	R-426 Technology Update—1974

Payment must accompany your order... USE THIS PAGE AS YOUR ORDER FORM

Make check or money order payable to Electronics Reprints. All orders shipped prepaid via parcel post. Allow two to three weeks for delivery.

Back Issues Now Available. 1960 to 1969 \$5.00 each. 1970 to 1973 \$3.00 each.

Mail Your Order To
Janice Austin
ELECTRONICS REPRINTS
P.O. Box 669
Hightstown, N.J. 08520

Amount of Order	\$ _____
Plus 10% Handling Charge	\$ _____
TOTAL AMOUNT ENCLOSED	\$ _____

SEND REPRINTS TO

Name _____
Company _____ Dept. _____
Street _____
City _____ State _____ Zip _____

Electronics advertisers

October 31, 1974

Abbott Transistor Labs, Inc. Technical Advertising Agency	6	ITT Semiconductors Hall & McKenzie Advertising	79
* Adret Electronique Psycho Publicite	17E	Kepeco, Inc. Weiss Advertising	5
Advanced Micro Devices Keye/Donna/Pearlstein	24	The London Company Technical Marketing Associates	109
* Allen Bradley Rodway Smith (Midlands) Limited	14E-15E	* LTT	20E
American Smelting and Refining Company Clyne Maxon, Inc.	63	Macrodata Company JMR Advertising	91
Analog Devices, Inc. Schneider Parker, Inc.	31	Micro Switch Division of Honeywell N.W. Ayer & Son, Inc.	15
* Anritsu Electric Co., Ltd. Diamond Agency Co., Ltd.	49	Motorola Semiconductor Products, Inc. E.B. Lane & Associates, Inc.	22-23
‡ Beckman Instruments Inc., Heliport Division N.W. Ayer/Jorgensen/MacDonald, Inc.	46	Nikkei-Electronics	96
Burroughs Corporation Conti Advertising	7	* Oscilloquartz SA, Neuchatel Publicitas	8E, 19E
Calma Company William Cain, Inc., Advertising	93	* Philips Elcoma Brookies Communications	12E
‡ Centralab Electronics Division Globe-Union, Inc. Action Communicators	49	* Philips Electrológica Intermarco Nederland	2E
Clairex Corporation Black-Russell-Morris	4th Cover	* Philips N.V. Pit/T & M Division Brookies Communications Systems SA	46
Computer Devices, Inc. Drumbeater	17	RCA—Solid State Division Marsteller, Inc.	60-61
Data General Corporation Scali, McCabe, Sloves, Inc.	76-77	RCL Electronics, Inc. Morvay Advertising Agency	14
‡ Data Precision Allied Advertising Agency, Inc.	43	* Rohde & Schwarz	1E
Data Translation, Inc. Mark L. Nigberg, Inc.	17	R-OHM Corp. Diversified Corporate Service, Inc.	40
Diallight Corporation Michel-Cather, Inc.	9	Schauer Manufacturing Corp. Nolan, Keelor & Stites	58
Digital Equipment Corporation Components Group Schneider Parker, Inc.	12-13	* Schlumberger	7E, 9E, 11E
Digital Equipment Corporation Creamer, Trowbridge, Case & Basford, Inc.	18	* Sescosem Bazaine Publicite	44
Electronic Arrays, Inc. Bondfield Associates	53	Solid State Scientific Inc., Montgomeryville, Pa. Aitkin-Kynett	2nd Cover
Electro Scientific Industries Commark Group, Inc.	39	Sprague Electric Company Harry P. Bridge Company	8
John Fluke Mfg., Co., Ltd. Lennox Marketing Limited	112	Systron Donner Concord Instruments Fred Schott & Associates	112
Fluke Manufacturing Co., John Bonfield Associates	33	Taiyo Denki Co., Ltd. Daipro, Inc.	108
* Gardner-Denver Co. Buchen Advertising, Inc.	43	Teledyne Philbrick Ingalls Associates	35-37
General Magnetics McCarthy/Scelba/DeBlasi Advertising Agency, Inc.	3rd Cover,	Tucker Electronics Company Taurus Marketing Agency	109
* General Radio Grad Associates	5E	Unitrode Corporation Culver Advertising, Inc.	21
General Radio Company Grad Associates	64	* Wandel und Goltermann Werbeagentur	10E
Gould Instruments Systems Marsteller, Inc.	50	Wavetek Indiana Chapman Michetti Advertising	98
Hewlett-Packard Tallant/Yates Advertising, Inc.	2	Wima, Westermann Oliver-Beckmann Gmbh	16
Hewlett-Packard Phillips Ramsey Advertising & Public Relations	1	Winchester Electronics Renaccio Advertising	10-11
Hybrid Systems Corporation Henry Scammell Associates	59		
International Lights, Inc. William W. Jeffrey	108		
Ithaco, Inc. Webb & Athey, Inc.	57		

Classified & Employment Advertising

F. J. Eberle, Manager 212-997-2557

#

EQUIPMENT (Used or Surplus New) For Sale	
American Used Computer	106
Electronic Discount Sales	106
Philip Fishman Company	106
Mountain West Alarm Supply Co.	106
Radio Research Instrument Co.	106
Women's Career Caucus	106

■ For more information on complete product line see advertisement in the latest Electronics Buyer's Guide

* Advertisers in Electronics International

‡ Advertisers in Electronics domestic-only edition

Advertising Sales Staff

Pierre J. Braudé New York [212] 997-3468
Director of Marketing

Atlanta, Ga. 30309: Joseph Lane
100 Colony Square, 1175 Peachtree St., N.E.
[404] 892-2868

Boston, Mass. 02116: James R. Pierce
607 Boylston St. [617] 262-1160

Chicago, Ill. 60611:
645 North Michigan Avenue
Robert W. Bartlett (312) 751-3739
Paul W. Reiss (312) 751-3738

Cleveland, Ohio 44113: William J. Boyle
[716] 586-5040

Dallas, Texas 75201: Charles G. Hybbard
2001 Bryant Tower, Suite 1070
[214] 742-1747

Denver, Colo. 80202: Harry B. Doyle, Jr.
Tower Bldg., 1700 Broadway
[303] 266-3863

Detroit, Michigan 48202: Robert W. Bartlett
1400 Fisher Bldg.
[313] 873-7410

Houston, Texas 77002: Charles G. Hubbard
Dresser Tower, 601 Jefferson St., [713] 424-8381

Los Angeles, Calif. 90010: Robert J. Rielly
Bradley K. Jones, 3200 Wilshire Blvd., South Tower
[213] 487-1160

New York, N.Y. 10020
1221 Avenue of the Americas
Warren H. Gardner [212] 997-3617
Michael J. Stoller [212] 997-3616

Philadelphia, Pa. 19102: Warren H. Gardner
Three Parkway,
[215] 997-3617

Pittsburgh, Pa. 15222: Warren H. Gardner
4 Gateway Center, [212] 997-3617

Rochester, N.Y. 14534: William J. Boyle
9 Greylock Ridge, Pittsford, N.Y.
[716] 586-5040

San Francisco, Calif. 94111: Don Farris
Robert J. Rielly, 425 Battery Street,
[415] 362-4600

Paris: Alain Offergeld
17 Rue-Georges Bizet, 75 Paris 16, France
Tel: 720-73-01

Geneva: Alain Offergeld
1 rue du Temple, Geneva, Switzerland
Tel: 32-35-63

United Kingdom & Scandinavia: Keith Mantle
Tel: 01-493-1451, 34 Dover Street, London W1

Milan: Robert Saidel
1 via Baracchini, Italy Phone 86-90-656

Brussels: Alain Offergeld
23 Chaussee de Wavre
Brussels 1040, Belgium
Tel: 13-73-95

Frankfurt/Main: Fritz Krusebecker
Liebigstrasse 27c, Germany
Phone 72 01 81

Tokyo: Tatsumi Katagiri, McGraw-Hill
Publications Overseas Corporation,
Kasumigaseki Building 2-5, 3-chome,
Kasumigaseki, Chiyoda-Ku, Tokyo, Japan
[581] 9811

Australasia: Warren E. Ball, IPO Box 5106,
Tokyo, Japan

Business Department

Stephen R. Weiss, Manager
[212] 997-2044

Thomas M. Egan,
Production Manager [212] 997-3140

Carol Gallagher
Assistant Production Manager [212] 997-2045

Dorothy Carter, Contracts and Billings
[212] 997-2908

Frances Vallone, Reader Service Manager
[212] 997-6057

Electronics Buyers' Guide

George F. Werner, Associate Publisher
[212] 997-3139

Regina Hera, Directory Manager
[212] 997-2544

Fluke mates

Advanced L.S.I. multimeter 26 ranges, 5 functions. \$299



8000A

- 3½ digit Fluke quality DMM
- Combines analog and digital LSI
- ac and dc volts, amps and ohms measurements
- 0.1% dc accuracy guaranteed for one full year
- Optional battery operation and data output
- Full 12-month guarantee

Autoranging LSI/MOS multi-function counter \$349

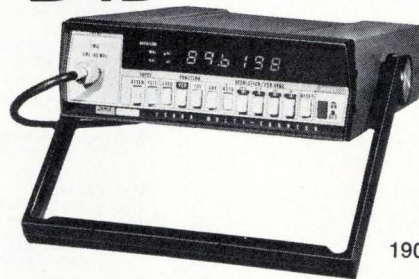

1900A

- Autoranging in both frequency and period measurements
- 5 Hz to 80 MHz, high sensitivity — 25 mV
- Event counting to 10⁶ events, automatic overflow
- Six digit LED display with automatic annunciation
- Optional battery operation and data output
- Full 12-month guarantee



John Fluke Mfg. Co. Ltd., P.O. Box 1094, Station "D"
Buffalo, N.Y., 14210. Phone (716) 842-0311. TWX 610-492-3214

Circle 112 on reader service card

Q. what's new from the specialists in waveform analysis?

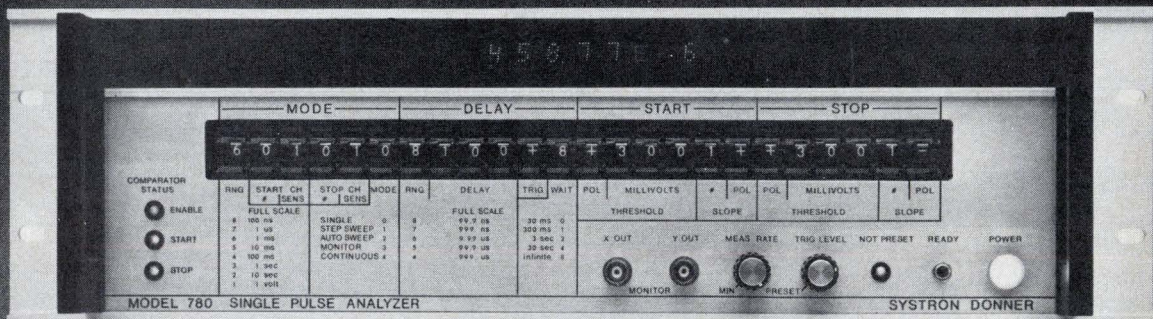

A. a systems measurement center that makes 3,000 measurements/sec!

Model 780 measures single transient to 100 MHz signals • Measures time from 0.1 ns to 10 s
Measures voltage with bandwidth from D.C. to 300 MHz • Calculator
or computer compatible • ASCII buss programming.

For information on Systron-Donner waveform analysis instruments call your Scientific Devices
office or Systron-Donner at 1 Systron Drive, Concord, CA 94518. Phone (415) 676-5000.

